

# SPECIFICATION

Device Name : IGBT Module

Type Name : 7MBR15SA140E-01

Spec. No. : MS6M 0549

Date : Jun. - 02 - 2000

Fuji Electric Co., Ltd.  
Matsumoto Factory

	DATE	NAME	APPROVED	Fuji Electric Co., Ltd.	
DRAWN	Jun - 2 - '00	<i>T. Koyashi</i>	<i>[Signature]</i>	MS6M 0549	1 / 10
CHECKED	June - 2 - 00	<i>S. Naito</i>			

This material and the information herein is the property of Fuji Electric Co., Ltd. They shall be neither reproduced, copied, lent, or disclosed in any way whatsoever for the use of any third party nor used for the manufacturing purposes without the express written consent of Fuji Electric Co., Ltd.

# Revised Records

Date	Classi- fication	Ind.	Content	Applied date	Drawn	Checked	Approved
Jun. - 2 - '60	enactment	—	—	Issued date	—	S. M. H. A.	J. N. Yoshida

This material and the information herein is the property of Fuji Electric Co., Ltd. They shall be neither reproduced, copied, lent, or disclosed in any way whatsoever for the use of any third party nor used for the manufacturing purposes without the express written consent of Fuji Electric Co., Ltd.

**Fuji Electric Co., Ltd.**

DWG. NO.

**MS6M 0549**

2 / 10

# 7MBR15SA140E-01

1. Outline Drawing ( Unit : mm )

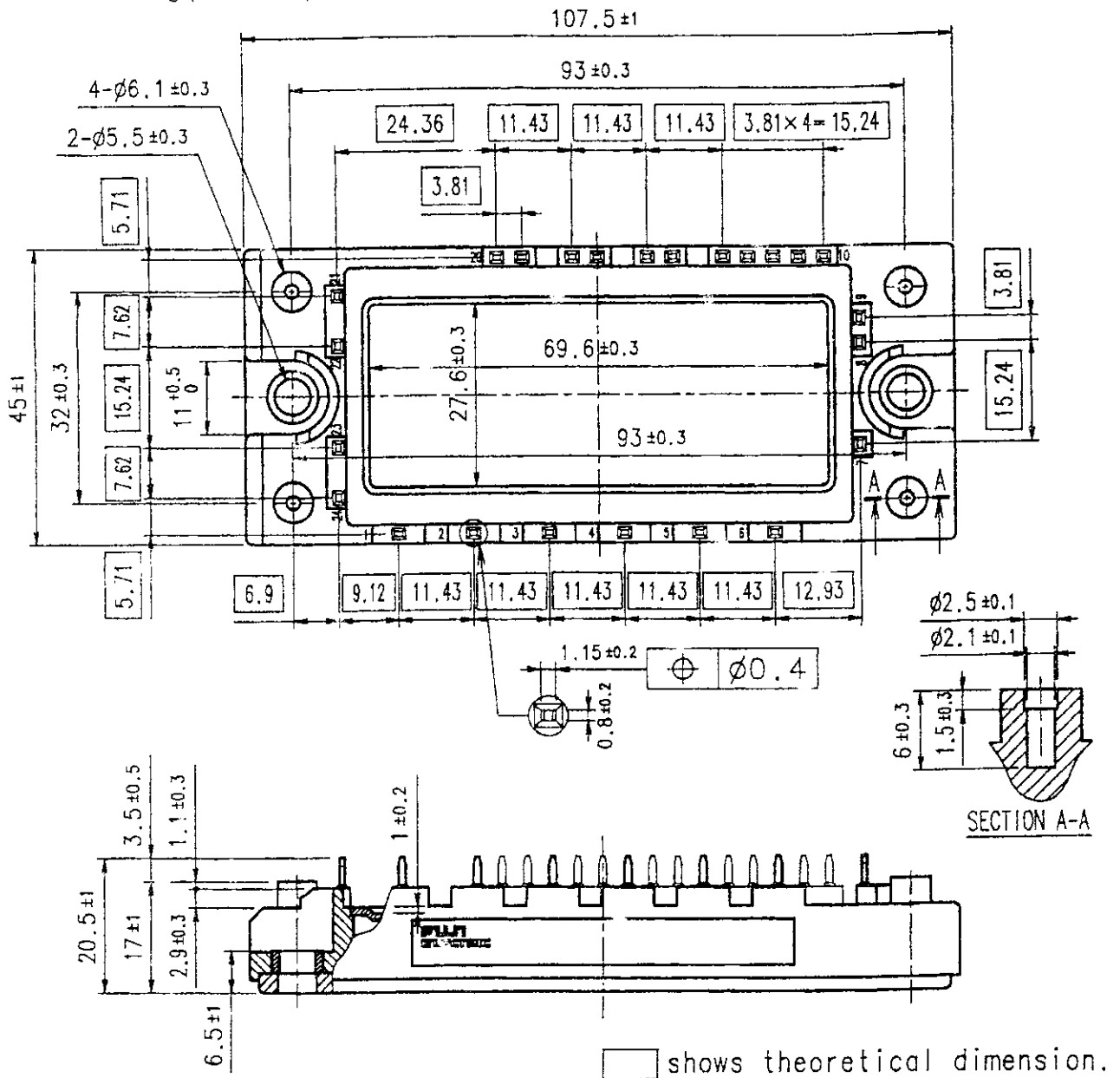

2. Equivalent circuit

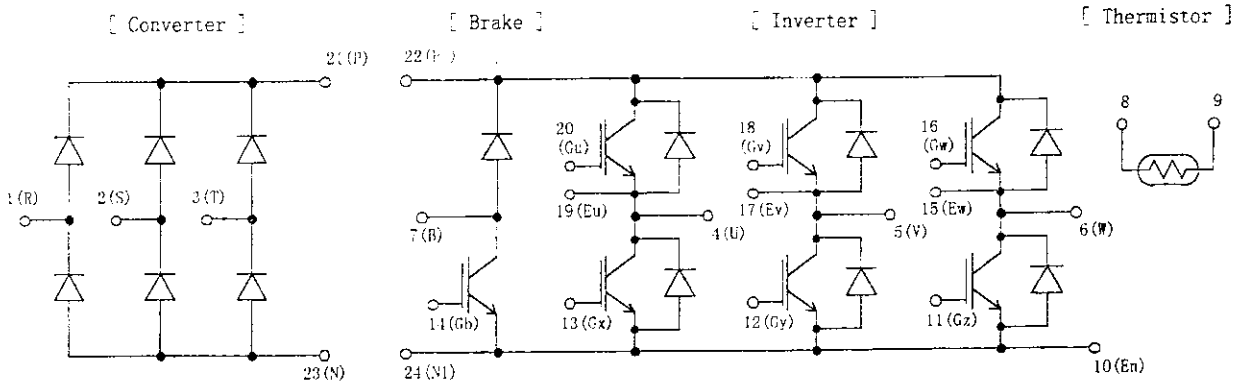

Fuji Electric Co., Ltd.

DWG. NO.

MS6M 0549

3 / 10

H04-004-03

This material and the information herein is the property of Fuji Electric Co. Ltd. They shall be neither reproduced, copied, lent, or disclosed in any way whatsoever for the use of any third party without the express written consent of Fuji Electric Co., Ltd.

3. Absolute Maximum Ratings ( at Tc= 25C unless otherwise specified )

Items		Symbols	Conditions		Maximum Ratings	Units
Inverter	Collector-Emitter voltage	VCES			1400	V
	Gate-Emitter voltage	VGES			+20	V
	Collector current	Ic	Continuous	Tc=25C	25	A
				Tc=75C	15	
		Icp	1ms	Tc=25C	50	A
				Tc=75C	30	
-Ic			15	A		
Collector Power Dissipation	Pc	1 device		110	W	
Brake	Collector-Emitter voltage	VCES			1400	V
	Gate-Emitter voltage	VGES			+20	V
	Collector current	Ic	Continuous	Tc=25C	25	A
				Tc=75C	15	
		Icp	1ms	Tc=25C	50	A
				Tc=75C	30	
Collector Power Dissipation	Pc	1 device		110	W	
Repetitive peak reverse Voltage(Diode)	VRRM			1400	V	
Converter	Repetitive peak reverse Voltage	VRRM			1600	V
	Average Output Current	Io	50Hz/60Hz sine wave		25	A
	Surge Current (Non-Repetitive)	IFSM	Tj=150C, 10ms		260	A
	I <sup>2</sup> t (Non-Repetitive)	I <sup>2</sup> t	half sine wave		338	A <sup>2</sup> s
Junction temperature	Tj			150	C	
Storage temperature	Tstg			-40~ +125	C	
Isolation voltage	between terminal and copper base <sup>(*1)</sup>	Viso	AC : 1min.		2500	V
	between thermistor and others <sup>(*2)</sup>				2500	V
Mounting Screw Torque <sup>(*3)</sup>				3.5	Nm	

(\*1) All terminals should be connected together when isolation test will be done.

(\*2) Terminal 8 and 9 should be connected together. Terminal 1 to 7 and 10 to 24 should be connected together and shorted to copper base.

(\*3) Recommendable Value : 2.5~3.5 Nm (M5)

This material and the information herein is the property of Fuji Electric Co. Ltd. They shall be neither reproduced, copied, lent, or disclosed in any way whatsoever for the use of any third party nor used for the manufacturing purposes without the express written consent of Fuji Electric Co., Ltd.

4. Electrical characteristics ( at Tj= 25C unless otherwise specified)

Items	Symbols	Conditions	Characteristics			Units			
			min.	typ.	Max.				
Inverter	Zero gate voltage Collector current	ICES	VGE	0 V, VCE	1400 V		1.0	mA	
	Gate-Emitter leakage current	IGES	VCE	0 V, VGE	+20 V		200	nA	
	Gate-Emitter threshold voltage	VGE(th)	VCE	20 V, Ic =	15 mA	5.5	7.2	8.5	V
	Collector-Emitter saturation voltage	VCE(sat)	VGE	15 V, chip			2.2		V
			Ic =	15 A terminal			2.25	2.7	
	Input capacitance	Cies	VGE	0 V, VCE	10 V		1800		pF
	Turn-on time	ton	Vcc=	800 V			0.35	1.2	us
		tr	Ic =	15 A			0.25	0.6	
		tr(0)	VGE	+15 V			0.1		
	Turn-off time	toff	RG =	82 ohm			0.45	1.0	us
		tf					0.08	0.3	
	Forward on voltage	VF	IF =	15 A chip			2.4		V
terminal						2.45	3.3		
Reverse recovery time	trr	IF =	15 A				350	ns	
Brake	Zero gate voltage Collector current	ICES	VGE	0 V, VCE	1400 V		1.0	mA	
	Gate-Emitter leakage current	IGES	VCE	0 V, VGE	+20 V		200	nA	
	Collector-Emitter saturation voltage	VCE(sat)	VGE	15 V, chip			2.2		V
			Ic =	15 A terminal			2.3	2.7	
	Turn-on time	ton	Vcc=	800 V			0.35	1.2	us
		tr	Ic =	15 A			0.25	0.6	
		toff	VGE	+15 V			0.45	1.0	
	Turn-off time	tf	RG =	82 ohm			0.08	0.3	us
	Reverse current	IRRM	VR =	1400 V				1.0	mA
	Forward on voltage	VFM	IF =	15 A chip			1.1		V
				terminal			1.2	1.5	
Reverse current	IRRM	VR =	1600 V				1.0	mA	
Thermistor	Resistance	R	T = 25C			5000		ohm	
			T = 100C			465	495		520
B value	B	T =	25/50C			3305	3375	3450	K

5. Thermal resistance characteristics

Items	Symbols	Conditions	Characteristics			Units
			min.	typ.	Max.	
Thermal resistance (1 device)	Rth(j-c)	Inverter IGBT			1.14	C/W
		Inverter FWD			1.85	
		Brake IGBT			1.14	
		Converter Diode			0.90	
Contact Thermal resistance	Rth(c-f)	with Thermal Compound (*)		0.05		C/W

\* This is the value which is defined mounting on the additional cooling fin with thermal compound.

Fuji Electric Co.,Ltd.

DWG.NO.

MS6M 0549

5 / 10

H04-004-03

This material and the information herein is the property of Fuji Electric Co. Ltd. They shall be neither reproduced, copied, lent, or disclosed in any way whatsoever for the use of any third party nor used for the manufacturing purposes without the express written consent of Fuji Electric Co., Ltd.

6. Indication on module

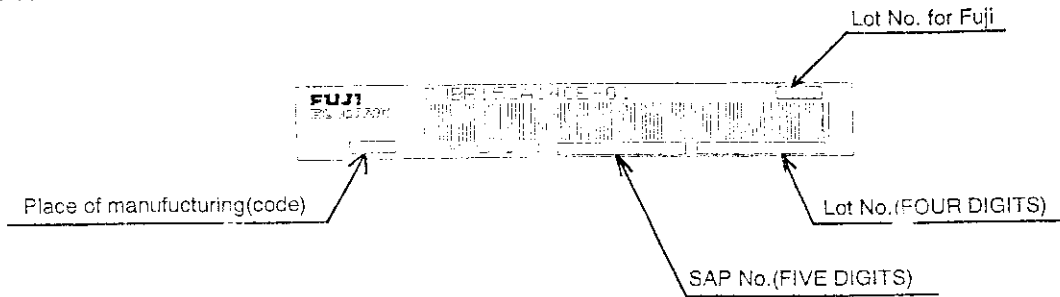

7. Applicable category

This specification is applied to Power Integrated Module named 7MBR15SA140E-01.

8. Storage and transportation notes (保管・運搬上の注意事項)

- The module should be stored at a standard temperature of 5 to 35°C and humidity of 45 to 75% .
- Store modules in a place with few temperature changes in order to avoid condensation on the module surface.
- Avoid exposure to corrosive gases and dust.
- Avoid excessive external force on the module.
- Store modules with unprocessed terminals.
- Do not drop or otherwise shock the modules when transporting.
- Please connect adequate fuse or protector of circuit between three-phase line and this product to prevent the equipment from causing secondary destruction.

9. Definitions of switching time

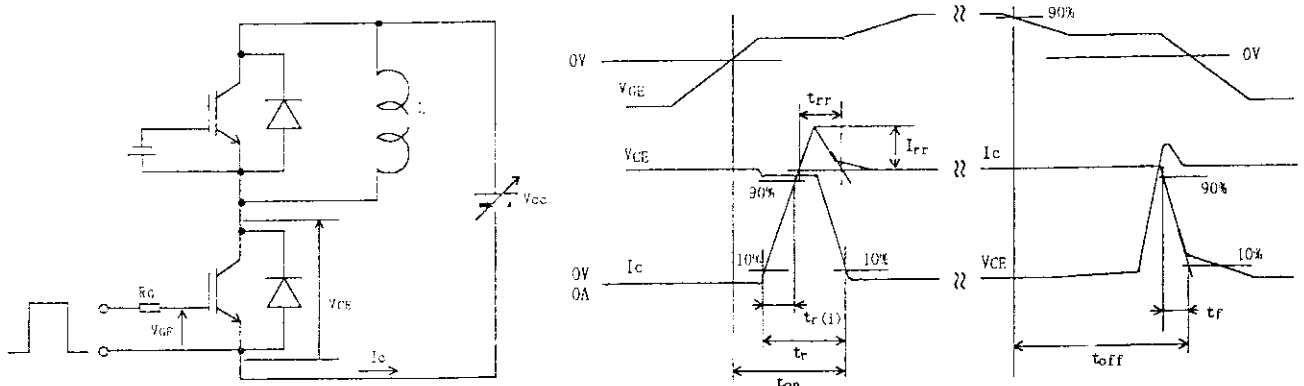

This material and the information herein is the property of Fuji Electric Co. Ltd. They shall be neither reproduced, copied, lent, or disclosed in any way whatsoever for the use of any third party, nor used for the manufacturing purposes without the express written consent of Fuji Electric Co., Ltd.

This material and the information herein is the property of Fuji Electric Co. Ltd. They shall be neither reproduced, copied, lent, or disclosed in any way whatsoever for the use of any third party nor used for the manufacturing purposes without the express written consent of Fuji Electric Co., Ltd.

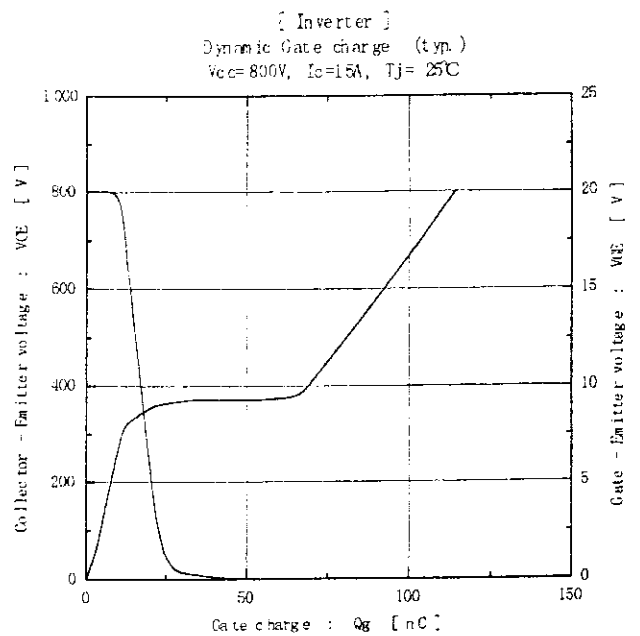
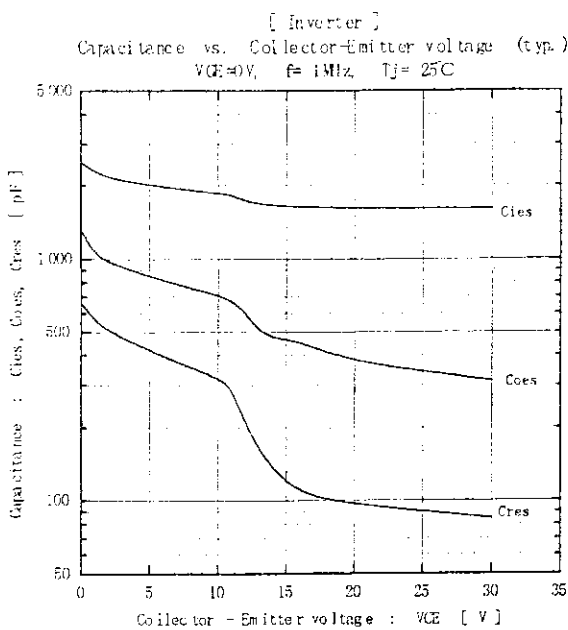
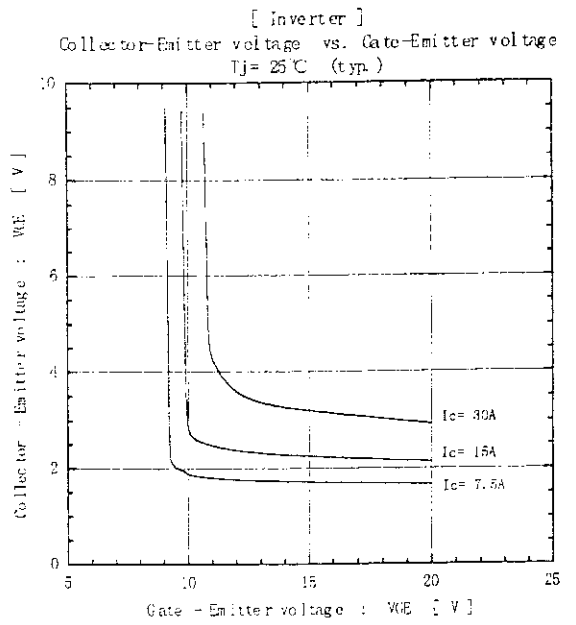
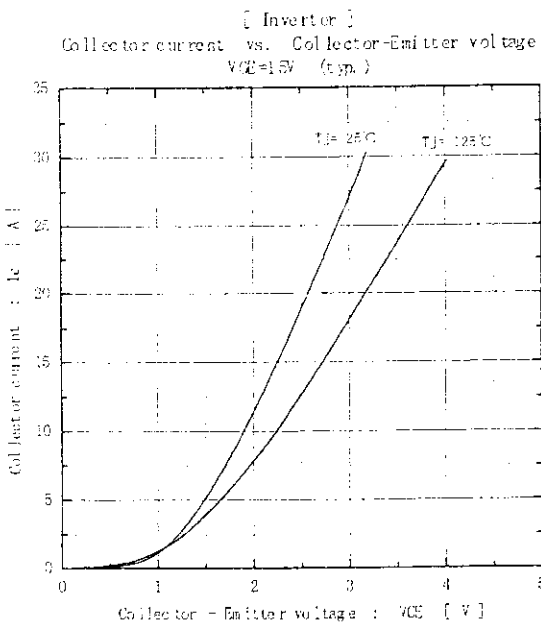
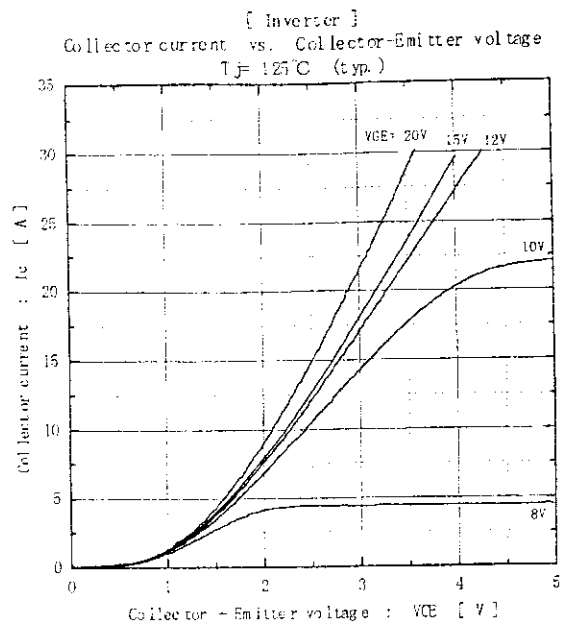
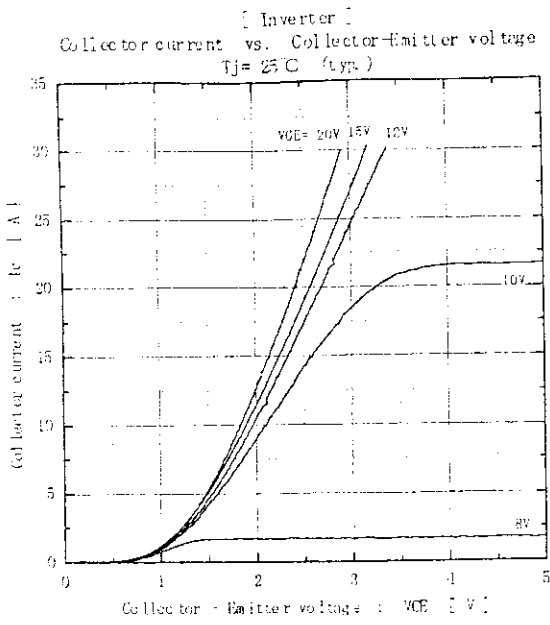

Fuji Electric Co., Ltd.

DWG. NO.

MS6M 0549

7 / 10

H04-004-03

This material and the information herein is the property of Fuji Electric Co., Ltd. They shall be neither reproduced, copied, lent, or disclosed in any way whatsoever for the use of any third party nor used for the manufacturing purposes without the express written consent of Fuji Electric Co., Ltd.

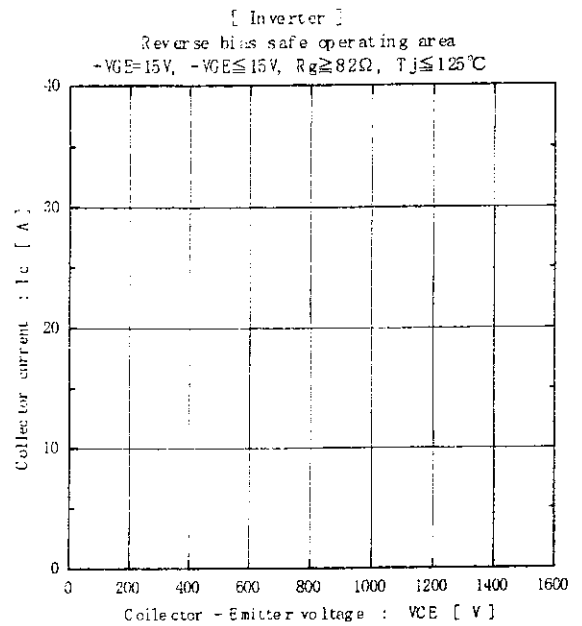
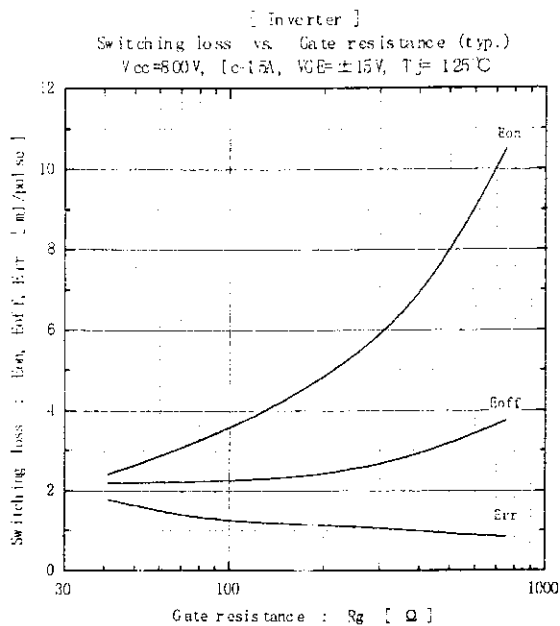
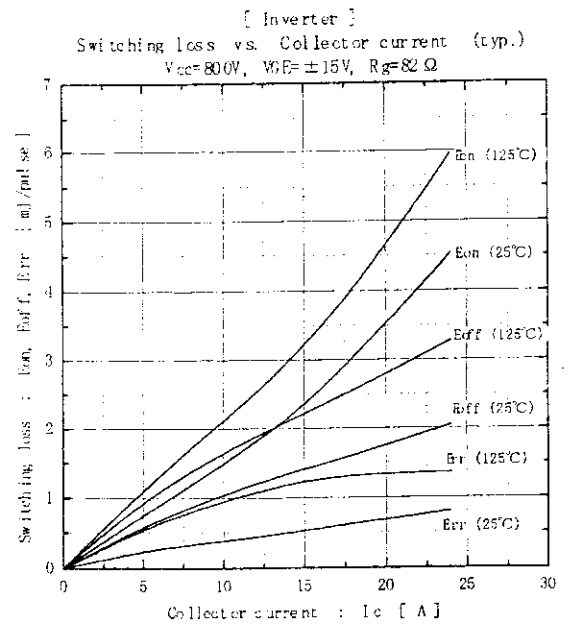
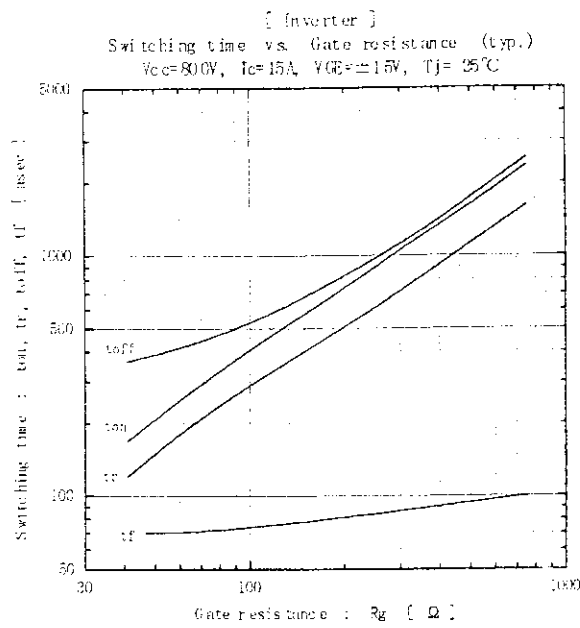
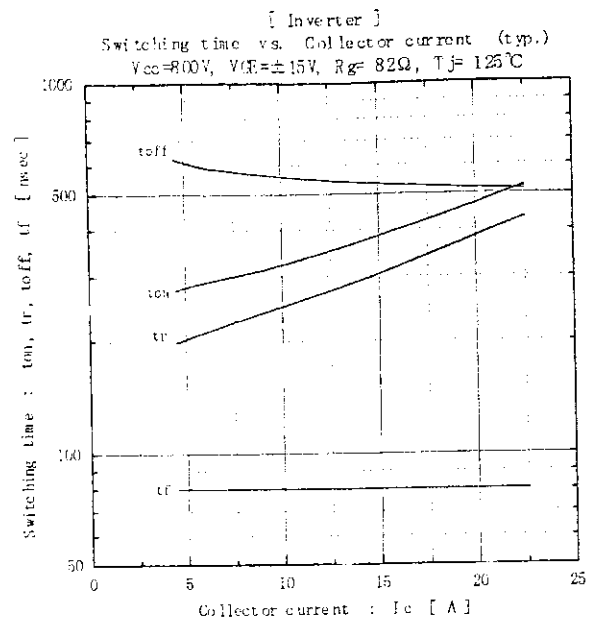
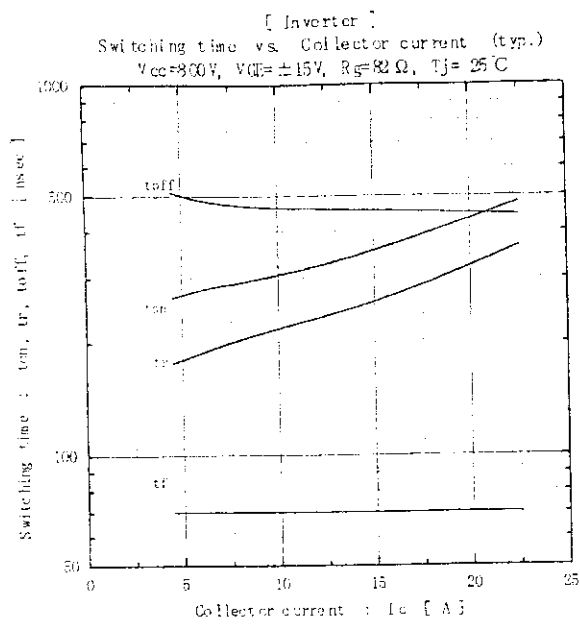

Fuji Electric Co., Ltd.

DWG. NO.

MS6M 0549

8 / 10

H04-004-03



This material and the information herein is the property of Fuji Electric Co. Ltd. They shall be neither reproduced, copied, lent, or disclosed in any way whatsoever for the use of any third party nor used for the manufacturing purposes without the express written consent of Fuji Electric Co., Ltd.

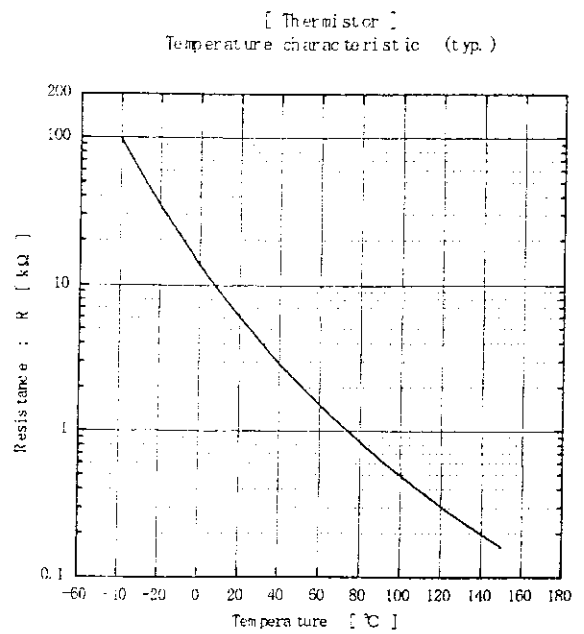
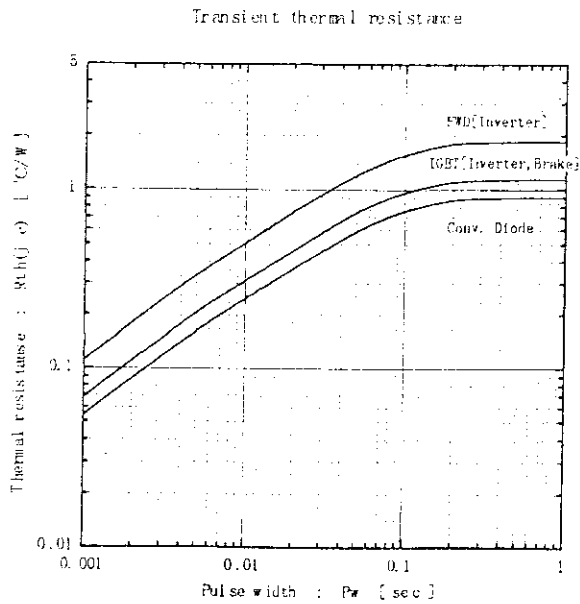
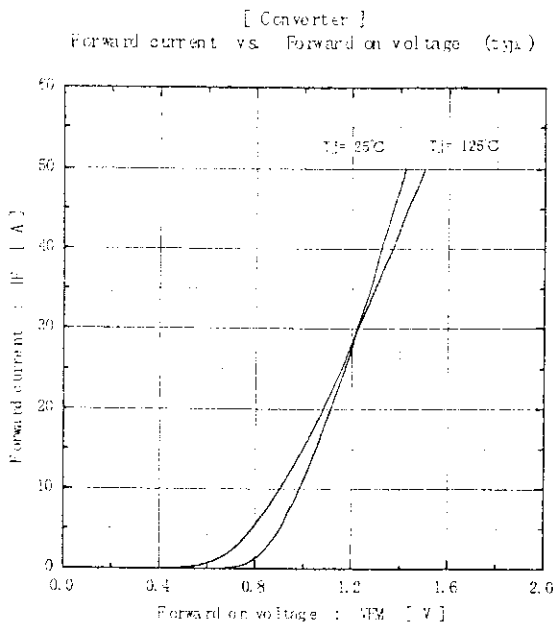
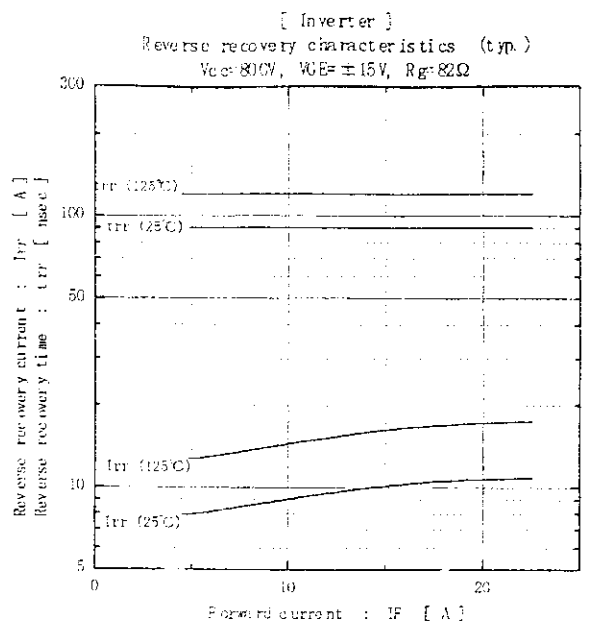
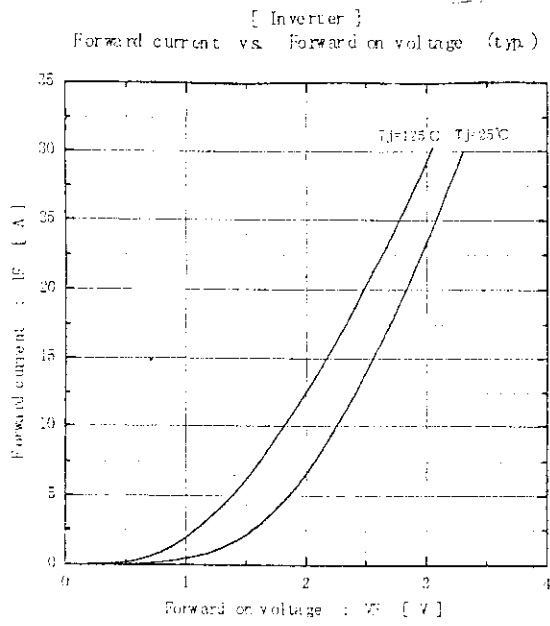

Fuji Electric Co., Ltd.

DWG. NO.

MS6M 0549

9 / 10

H04-004-03

This material and the information herein is the property of Fuji Electric Co Ltd. They shall be neither reproduced, copied, lent, or disclosed in any way whatsoever for the use of any third party nor used for the manufacturing purposes without the express written consent of Fuji Electric Co., Ltd.

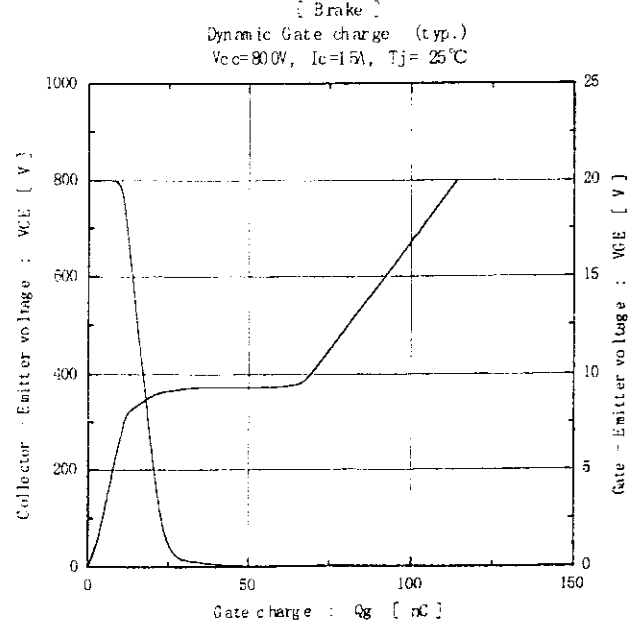
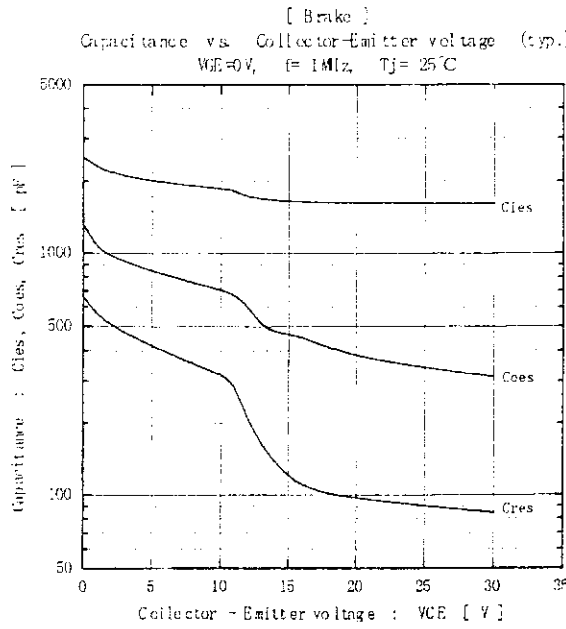
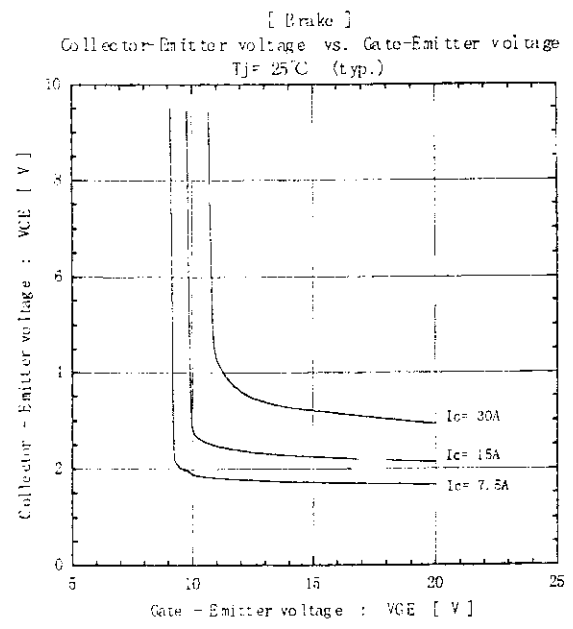
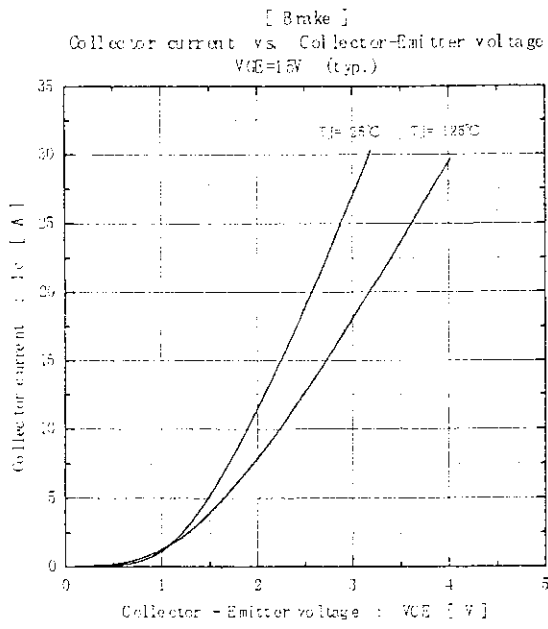
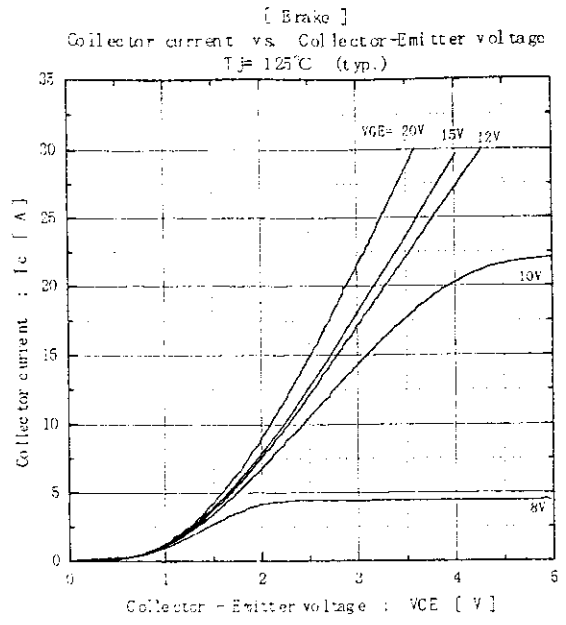
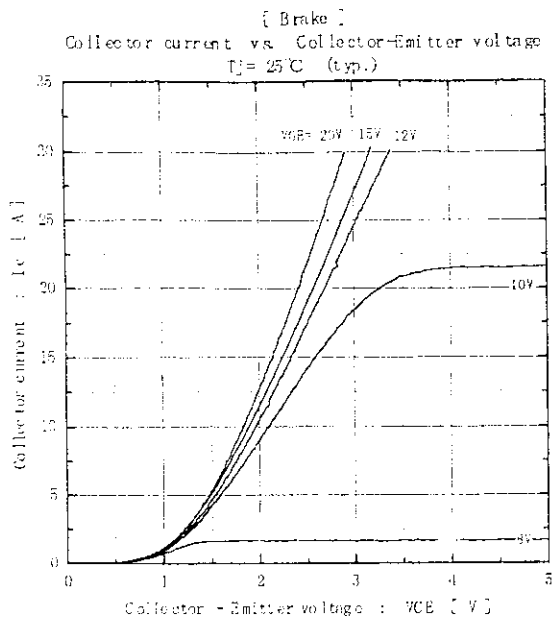

Fuji Electric Co., Ltd.

DWG. NO.

MS6M 0549

10/10

H04-004-03