

7MBR15VKA060-50

IGBT Modules

IGBT MODULE (V series) 600V / 10A / PIM

■ Features

- Low $V_{CE(sat)}$
- Compact Package
- P.C.Board Mount Module
- Converter Diode Bridge Dynamic Brake Circuit
- RoHS compliant product

■ Applications

- Inverter for Motor Drive
- AC and DC Servo Drive Amplifier
- Uninterruptible Power Supply

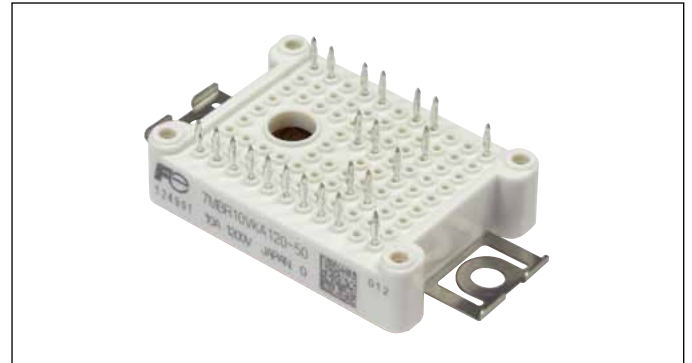

■ Maximum Ratings and Characteristics

● Absolute Maximum Ratings (at $T_c=25^\circ\text{C}$ unless otherwise specified)

| Items | Symbols | Conditions | Maximum ratings | Units | | |
|---|---|-----------------|-------------------------------|-------------------------|----------------------|---|
| Inverter | Collector-Emitter voltage | V_{CES} | | 600 | V | |
| | Gate-Emitter voltage | V_{GES} | | ± 20 | V | |
| | Collector current | I_c | Continuous | $T_c=100^\circ\text{C}$ | 15 | A |
| | | I_{cp} | 1ms | $T_c=80^\circ\text{C}$ | 30 | |
| | | $-I_c$ | | | 15 | |
| | $-I_{c\ pulse}$ | 1ms | | 30 | | |
| Collector power dissipation | P_c | 1 device | | 85 | W | |
| Brake | Collector-Emitter voltage | V_{CES} | | 600 | V | |
| | Gate-Emitter voltage | V_{GES} | | ± 20 | V | |
| | Collector current | I_c | Continuous | $T_c=80^\circ\text{C}$ | 15 | A |
| | | I_{cp} | 1ms | $T_c=80^\circ\text{C}$ | 30 | |
| | Collector power dissipation | P_c | 1 device | | 85 | W |
| Repetitive peak reverse voltage (Diode) | V_{RRM} | | | 600 | V | |
| Converter | Repetitive peak reverse voltage | V_{RRM} | | 800 | V | |
| | Average output current | I_o | 50Hz/60Hz, sine wave | 15 | A | |
| | Surge current (Non-Repetitive) | I_{FSM} | 10ms, $T_j=150^\circ\text{C}$ | 360 | A | |
| | I^2t (Non-Repetitive) | I^2t | half sine wave | 660 | A^2s | |
| Junction temperature | T_j | Inverter, Brake | | 175 | $^\circ\text{C}$ | |
| | | Converter | | 150 | | |
| Operating junction temperature (under switching conditions) | T_{jop} | Inverter, Brake | | 150 | | |
| | | Converter | | 150 | | |
| Case temperature | T_c | | | 125 | | |
| Storage temperature | T_{stg} | | | -40 to +125 | | |
| Isolation voltage | between terminal and copper base (*1) between thermistor and others (*2) | V_{iso} | AC : 1min. | 2500 | VAC | |
| Screw torque | Mounting (*3) | - | M4 | 1.7 | Nm | |

Note *1: All terminals should be connected together during the test.

Note *2: Two thermistor terminals should be connected together, other terminals should be connected together and shorted to base plate during the test.

Note *3: Recommendable value : 1.3-1.7 Nm (M4)

● Electrical characteristics (at T_j = 25°C unless otherwise specified)

| Items | Symbols | Conditions | Characteristics | | | Units | | |
|------------------------|--------------------------------------|------------------------------------|--|------------------------|------|-------|------|---|
| | | | min. | typ. | max. | | | |
| Inverter | Zero gate voltage collector current | I _{CES} | V _{GE} = 0V, V _{CE} = 600V | - | - | 1.0 | mA | |
| | Gate-Emitter leakage current | I _{GES} | V _{CE} = 0V, V _{GE} = ±20V | - | - | 200 | nA | |
| | Gate-Emitter threshold voltage | V _{GE(th)} | V _{CE} = 20V, I _c = 15mA | 6.2 | 6.7 | 7.2 | V | |
| | Collector-Emitter saturation voltage | V _{CE(sat)} (terminal) | V _{GE} = 15V I _c = 15A | T _j = 25°C | - | 1.95 | 2.35 | V |
| | | | | T _j = 125°C | - | 2.35 | - | |
| | | | | T _j = 150°C | - | 2.45 | - | |
| | | V _{CE(sat)} (chip) | V _{GE} = 15V I _c = 15A | T _j = 25°C | - | 1.75 | 2.15 | |
| | | | | T _j = 125°C | - | 2.15 | - | |
| | T _j = 150°C | - | 2.25 | - | | | | |
| | Internal gate resistance | R _{g(int)} | - | - | 0 | - | Ω | |
| | Input capacitance | C _{ies} | V _{CE} = 10V, V _{GE} = 0V, f = 1MHz | - | 0.9 | - | nF | |
| | Turn-on time | ton | V _{CC} = 300V I _c = 15A V _{GE} = +15 / -15V R _G = 22Ω | - | 0.08 | 1.20 | μs | |
| | | tr | | - | 0.06 | 0.60 | | |
| | | tr(i) | | - | 0.02 | - | | |
| | Turn-off time | toff | R _G = 22Ω | - | 0.14 | 1.20 | μs | |
| tf | | - | | 0.02 | 0.45 | | | |
| Forward on voltage | V _F (terminal) | I _F = 15A | T _j = 25°C | - | 1.95 | 2.35 | V | |
| | | | T _j = 125°C | - | 1.90 | - | | |
| | | | T _j = 150°C | - | 1.90 | - | | |
| | V _F (chip) | I _F = 15A | T _j = 25°C | - | 1.75 | 2.15 | | |
| | | | T _j = 125°C | - | 1.70 | - | | |
| T _j = 150°C | - | 1.70 | - | | | | | |
| Reverse recovery time | trr | I _F = 15A | - | - | 0.35 | μs | | |
| Brake | Zero gate voltage collector current | I _{CES} | V _{GE} = 0V V _{CE} = 600V | - | - | 1.0 | mA | |
| | Gate-Emitter leakage current | I _{GES} | V _{CE} = 0V V _{GE} = +20 / -20V | - | - | 200 | nA | |
| | Collector-Emitter saturation voltage | V _{CE(sat)} (terminal) | V _{GE} = 15V I _c = 15A | T _j = 25°C | - | 1.95 | 2.35 | V |
| | | | | T _j = 125°C | - | 2.35 | - | |
| | | | | T _j = 150°C | - | 2.45 | - | |
| | | V _{CE(sat)} (chip) | V _{GE} = 15V I _c = 15A | T _j = 25°C | - | 1.75 | 2.15 | |
| | | | | T _j = 125°C | - | 2.15 | - | |
| | T _j = 150°C | - | 2.25 | - | | | | |
| | Internal gate resistance | R _{g(int)} | - | - | 0 | - | Ω | |
| | Turn-on time | ton | V _{CE} = 300V I _c = 15A V _{GE} = +15 / -15V R _G = 22Ω | - | 0.08 | 1.20 | μs | |
| tr | | - | | 0.06 | 0.60 | | | |
| Turn-off time | toff | R _G = 22Ω | - | 0.14 | 1.20 | μs | | |
| | tf | | - | 0.02 | 0.45 | | | |
| Reverse current | IRRM | V _R = 600V | - | - | 1.00 | mA | | |
| Converter | Forward on voltage | I _F = 15A | terminal | - | 1.20 | 1.65 | V | |
| | | | chip | - | 1.00 | - | | |
| Reverse current | IRRM | V _R = 800V | - | - | 1.00 | mA | | |
| Thermistor | Resistance | T = 25°C | - | 5000 | - | Ω | | |
| | | T = 100°C | 465 | 495 | 520 | | | |
| B value | B | T = 25 / 50°C | 3305 | 3375 | 3450 | K | | |

● Thermal resistance characteristics

| Items | Symbols | Conditions | Characteristics | | | Units |
|---|----------------------|-----------------------|-----------------|------|------|-------|
| | | | min. | typ. | max. | |
| Thermal resistance (1device) | R _{th(j-c)} | Inverter IGBT | - | - | 1.80 | °C/W |
| | | Inverter FWD | - | - | 2.31 | |
| | | Brake IGBT | - | - | 1.80 | |
| | | Converter Diode | - | - | 1.35 | |
| Contact thermal resistance (1device) (*4) | R _{th(c-f)} | with Thermal Compound | - | 0.05 | - | |

Note *4: This is the value which is defined mounting on the additional cooling fin with thermal compound.

■ Characteristics (Representative)

[Inverter]

Collector current vs. Collector-Emittor voltage (typ.)
Tj= 25°C / chip

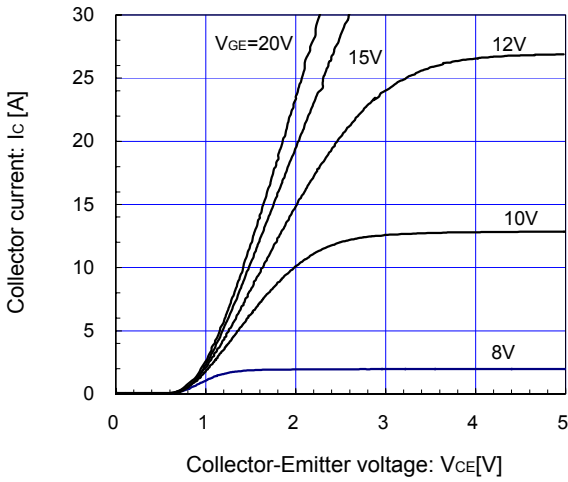

[Inverter]

Collector current vs. Collector-Emittor voltage (typ.)
Tj= 150°C / chip

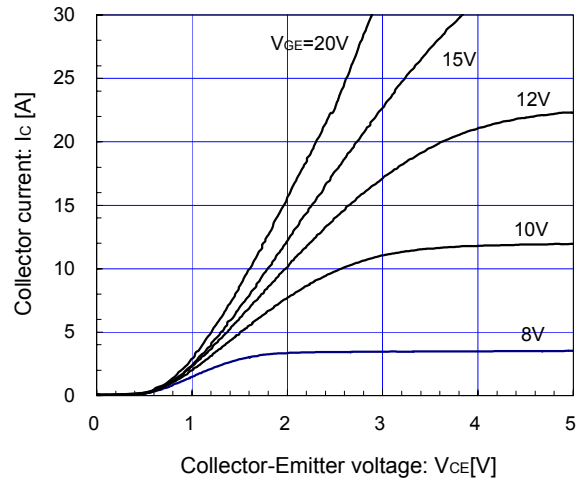

[Inverter]

Collector current vs. Collector-Emittor voltage (typ.)
VGE=15V / chip

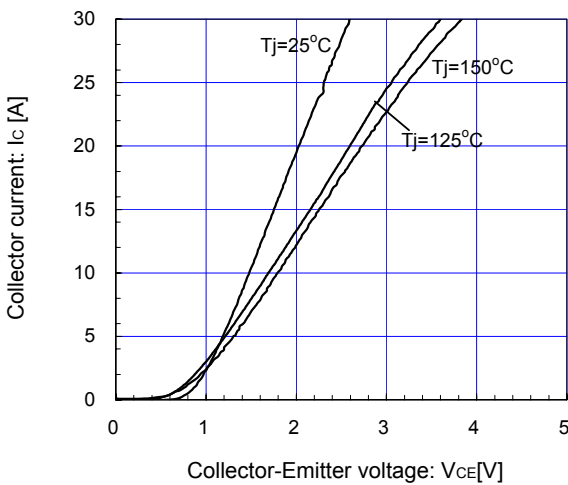

[Inverter]

Collector-Emittor voltage vs. Gate-Emittor voltage (typ.)
Tj= 25°C / chip

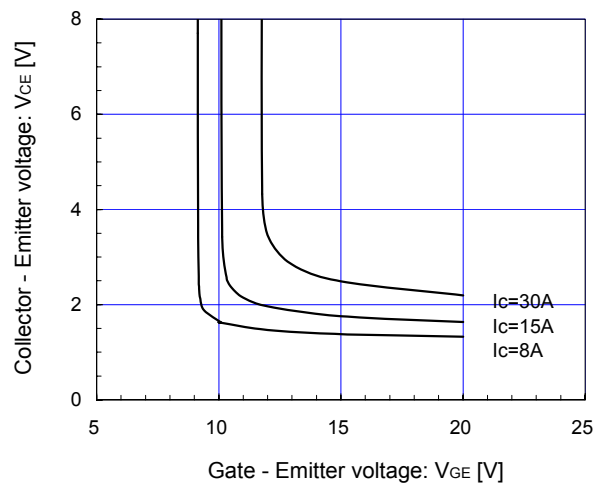

[Inverter]

Capacitance vs. Collector-Emittor voltage (typ.)
VGE=0V, f= 1MHz, Tj= 25°C

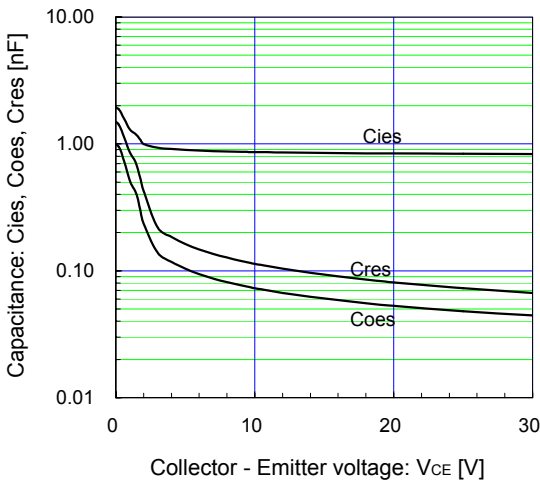

[Inverter]

Dynamic gate charge (typ.)
Vcc=300V, Ic=15A, Tj= 25°C

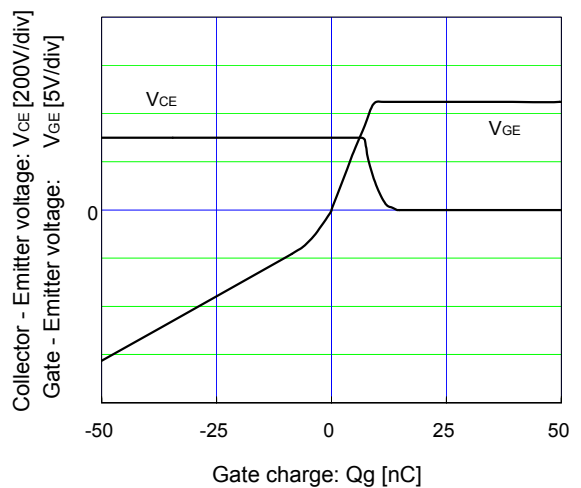

[Inverter]

Switching time vs. Collector current (typ.)
 $V_{CC}=300V, V_{GE}=\pm 15V, R_g=22\Omega, T_j=125^\circ C$

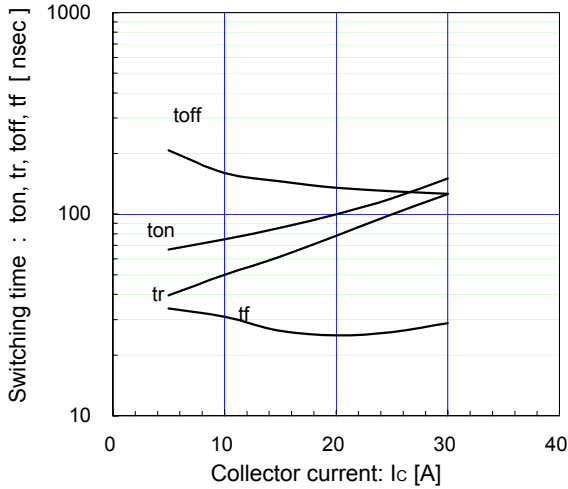

[Inverter]

Switching time vs. Collector current (typ.)
 $V_{CC}=300V, V_{GE}=\pm 15V, R_g=22\Omega, T_j=150^\circ C$

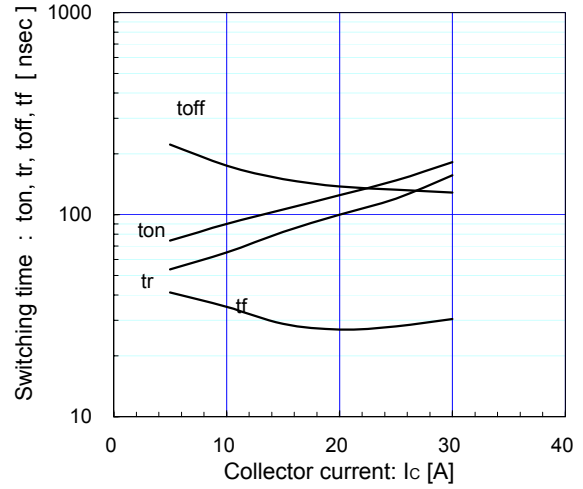

[Inverter]

Switching time vs. gate resistance (typ.)
 $V_{CC}=300V, I_c=15A, V_{GE}=\pm 15V, T_j=125^\circ C$

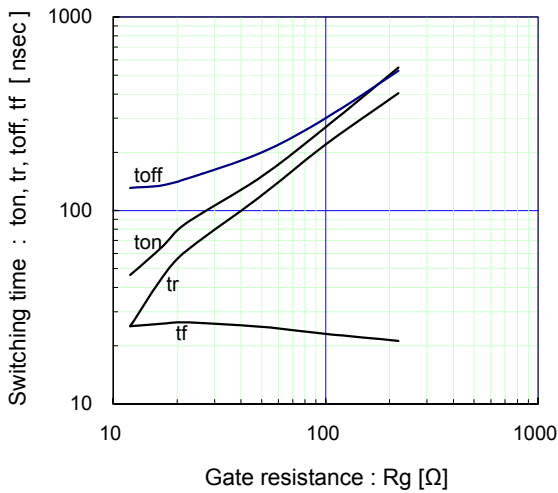

[Inverter]

Switching loss vs. Collector current (typ.)
 $V_{CC}=300V, V_{GE}=\pm 15V, R_g=22\Omega$

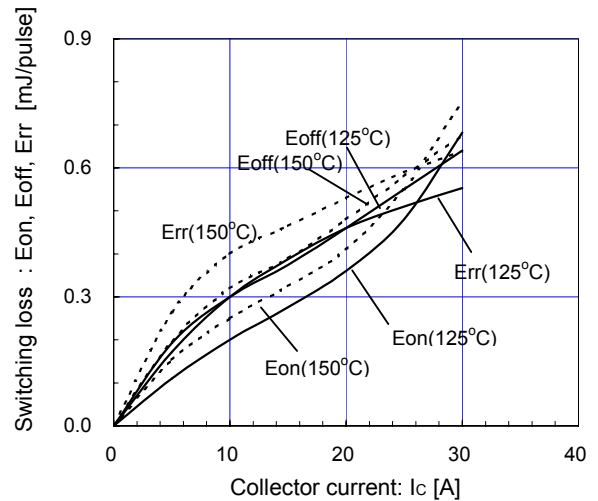

[Inverter]

Switching loss vs. gate resistance (typ.)
 $V_{CC}=300V, I_c=15A, V_{GE}=\pm 15V$

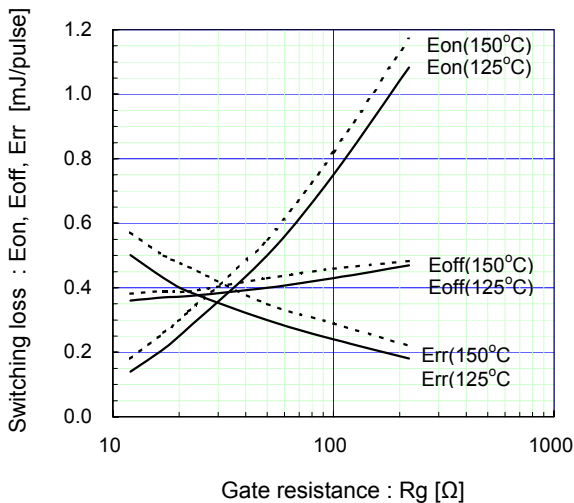

[Inverter]

Reverse bias safe operating area (max.)
 $+V_{GE}=15V, -V_{GE} \le 15V, R_g \ge 22\Omega, T_j = 150^\circ C$

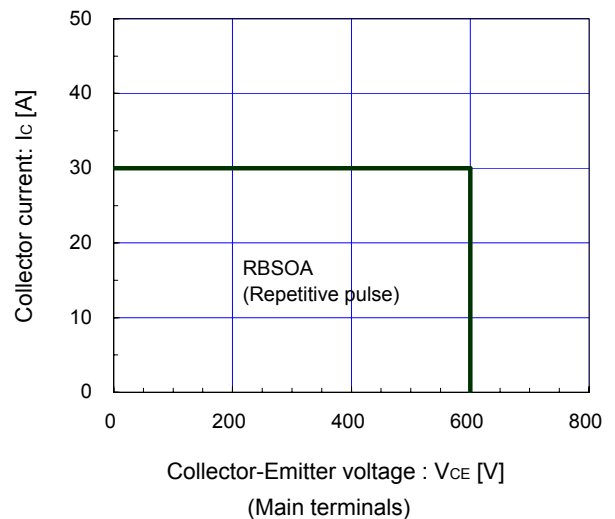

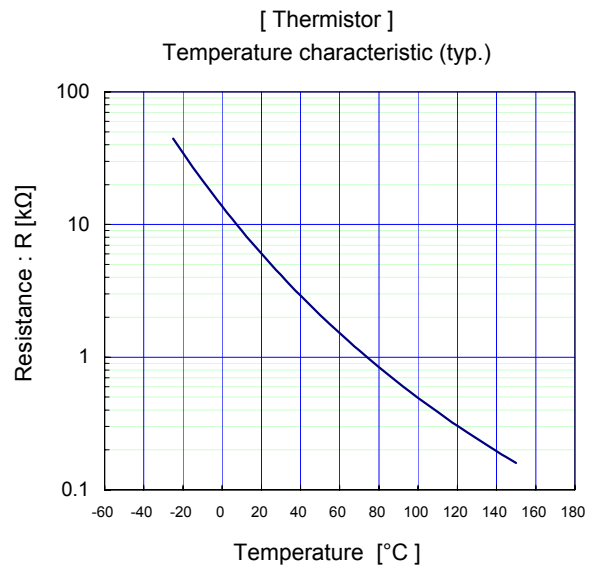
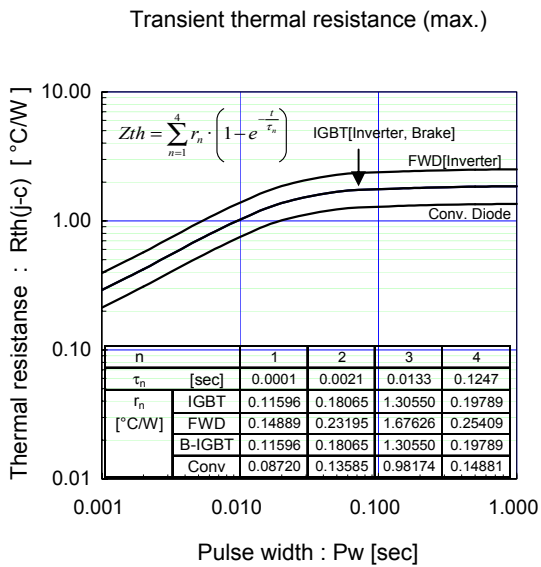
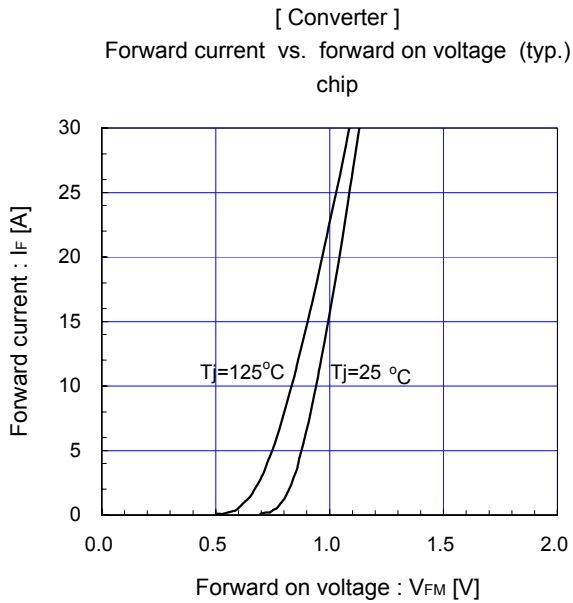
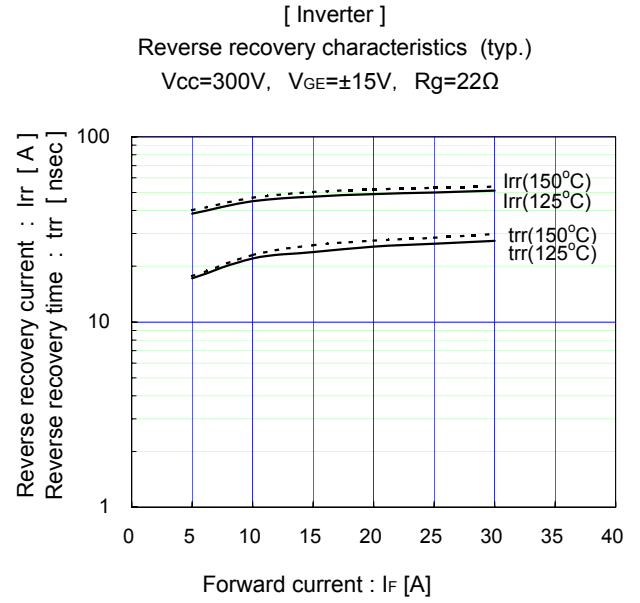
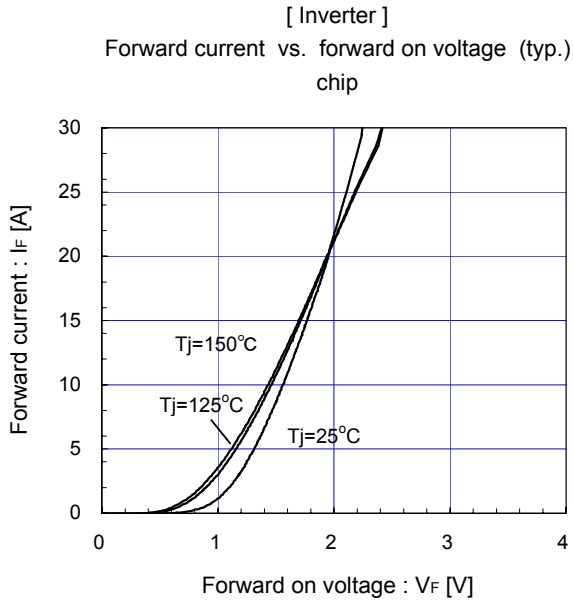

[Brake]

Collector current vs. Collector-Emittor voltage (typ.)
T_j= 25°C / chip

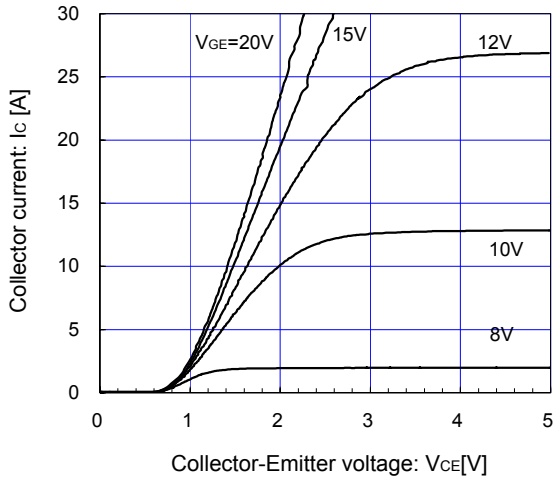

[Brake]

Collector current vs. Collector-Emittor voltage (typ.)
T_j= 150°C / chip

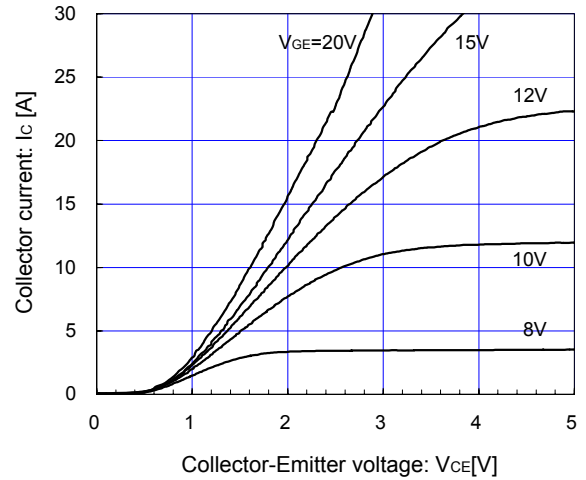

[Brake]

Collector current vs. Collector-Emittor voltage (typ.)
V_{GE}=15V / chip

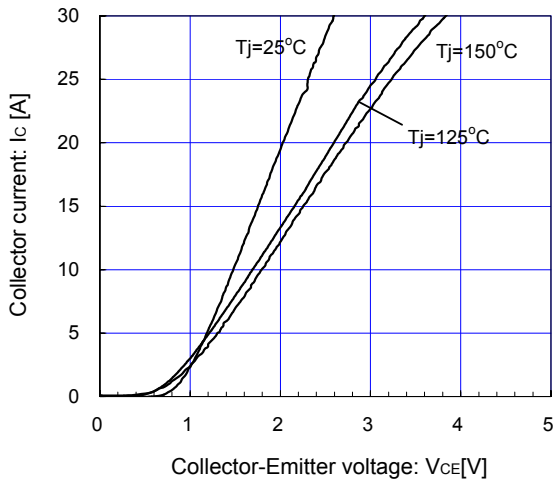

[Brake]

Collector-Emittor voltage vs. Gate-Emittor voltage (typ.)
T_j= 25°C / chip

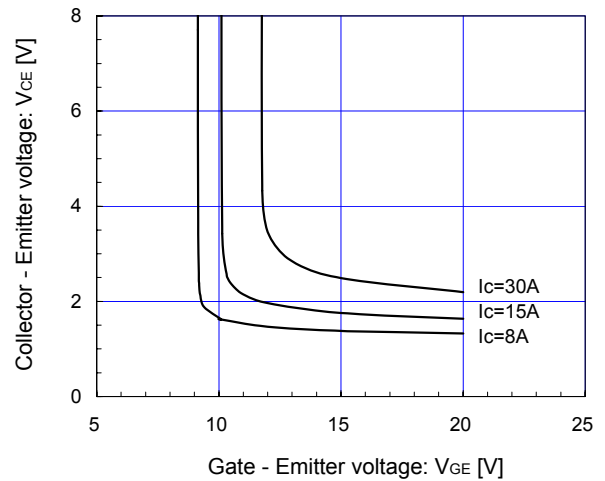

[Brake]

Capacitance vs. Collector-Emittor voltage (typ.)
V_{GE}=0V, f= 1MHz, T_j= 25°C

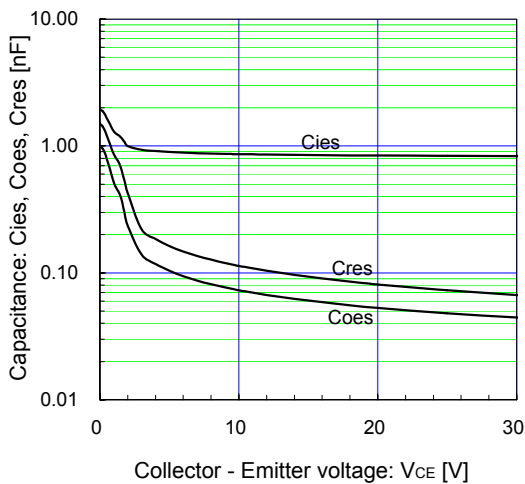

[Brake]

Dynamic gate charge (typ.)
V_{CC}=300V, I_c=15A, T_j= 25°C

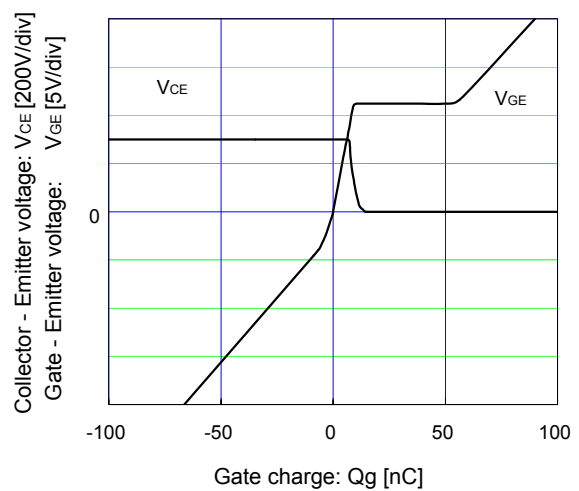

Outline Drawings, mm

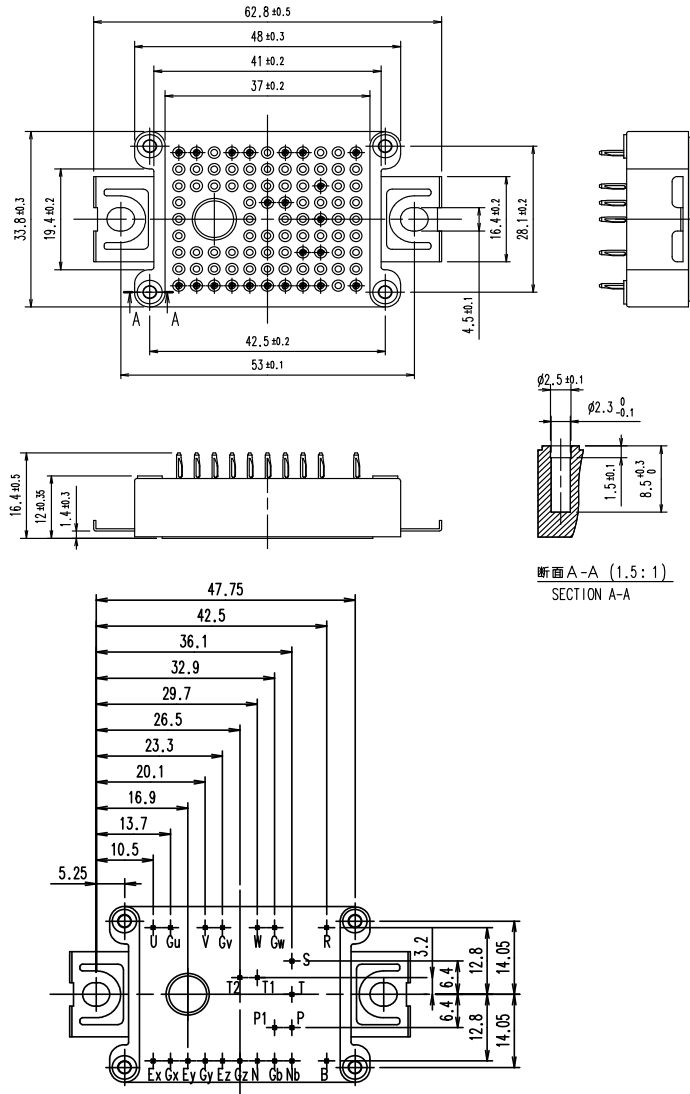

Weight: 25g(typ.)

Equivalent Circuit Schematic

[Converter] [Brake] [Inverter] [Thermistor]

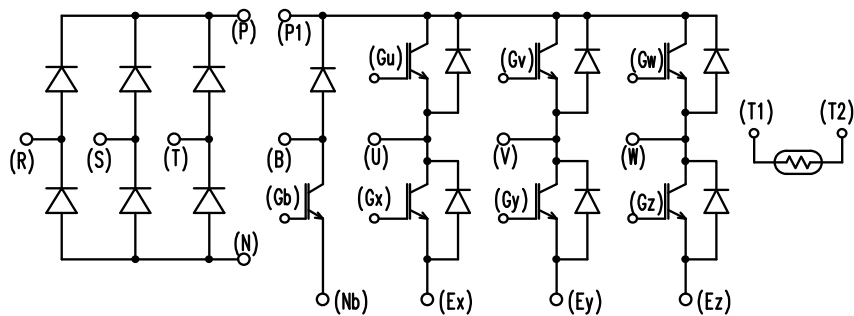

WARNING

1. This Catalog contains the product specifications, characteristics, data, materials, and structures as of November 2013. The contents are subject to change without notice for specification changes or other reasons. When using a product listed in this Catalog, be sure to obtain the latest specifications.
2. All applications described in this Catalog exemplify the use of Fuji's products for your reference only. No right or license, either express or implied, under any patent, copyright, trade secret or other intellectual property right owned by Fuji Electric Co., Ltd. is (or shall be deemed) granted. Fuji Electric Co., Ltd. makes no representation or warranty, whether express or implied, relating to the infringement or alleged infringement of other's intellectual property rights which may arise from the use of the applications described herein.
3. Although Fuji Electric Co., Ltd. is enhancing product quality and reliability, a small percentage of semiconductor products may become faulty. When using Fuji Electric semiconductor products in your equipment, you are requested to take adequate safety measures to prevent the equipment from causing a physical injury, fire, or other problem if any of the products become faulty. It is recommended to make your design fail-safe, flame retardant, and free of malfunction.
4. The products introduced in this Catalog are intended for use in the following electronic and electrical equipment which has normal reliability requirements.

| | | | |
|-----------------|-------------------------|---|--------------------------|
| • Computers | • OA equipment | • Communications equipment (terminal devices) | • Measurement equipment |
| • Machine tools | • Audiovisual equipment | • Electrical home appliances | • Personal equipment |
| | | | • Industrial robots etc. |
5. If you need to use a product in this Catalog for equipment requiring higher reliability than normal, such as for the equipment listed below, it is imperative to contact Fuji Electric Co., Ltd. to obtain prior approval. When using these products for such equipment, take adequate measures such as a backup system to prevent the equipment from malfunctioning even if a Fuji's product incorporated in the equipment becomes faulty.

| | |
|---|---|
| • Transportation equipment (mounted on cars and ships) | • Trunk communications equipment |
| • Traffic-signal control equipment | • Gas leakage detectors with an auto-shut-off feature |
| • Emergency equipment for responding to disasters and anti-burglary devices | • Safety devices |
| • Medical equipment | |
6. Do not use products in this Catalog for the equipment requiring strict reliability such as the following and equivalents to strategic equipment (without limitation).

| | | |
|--------------------------------|------------------------|-----------------------------|
| • Space equipment | • Aeronautic equipment | • Nuclear control equipment |
| • Submarine repeater equipment | | |
7. Copyright ©1996-2013 by Fuji Electric Co., Ltd. All rights reserved.
No part of this Catalog may be reproduced in any form or by any means without the express permission of Fuji Electric Co., Ltd.
8. If you have any question about any portion in this Catalog, ask Fuji Electric Co., Ltd. or its sales agents before using the product. Neither Fuji Electric Co., Ltd. nor its agents shall be liable for any injury caused by any use of the products not in accordance with instructions set forth herein.