

### IGBT MODULE

600V / 30A / PIM

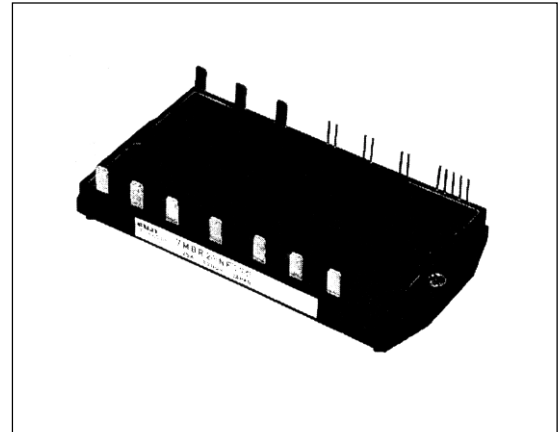

#### ■ Features

- High Speed Switching
- Voltage Drive
- Low Inductance Module Structure
- Converter Diode Bridge Dynamic Brake Circuit

#### ■ Applications

- Inverter for Motoe Drive
- AC and DC Servo Drive Amplifier
- Uninterruptible Power Supply

#### ■ Maximum ratings and characteristics

● Absolute maximum ratings (Tc=25°C unless without specified)

Item	Symbol	Condition	Rating	Unit	
Inverter	Collector-Emitter voltage	V <sub>CES</sub>	600	V	
	Gate-Emitter voltage	V <sub>GES</sub>	±20	V	
	Collector current	DC	I <sub>C</sub>	30	A
		1ms	I <sub>CP</sub>	60	A
		DC	-I <sub>C</sub>	30	A
Collector power dissipation	1 device	P <sub>C</sub>	120	W	
Brake	Collector-Emitter voltage	V <sub>CES</sub>	600	V	
	Gate-Emitter voltage	V <sub>GES</sub>	±20	V	
	Collector current	DC	I <sub>C</sub>	30	A
		1ms	I <sub>CP</sub>	60	A
	Collector power dissipation	1 device	P <sub>C</sub>	120	W
	Repetitive peak reverse voltage	V <sub>R<sub>RM</sub></sub>		600	V
	Average forward current	I <sub>F(AV)</sub>		1	A
	Surge current	I <sub>FSM</sub>	10ms	50	A
	Converter	Repetitive peak reverse voltage	V <sub>R<sub>RM</sub></sub>	800	V
		Non-Repetitive peak reverse voltage	V <sub>R<sub>SM</sub></sub>	900	V
Average output current		I <sub>O</sub>	50Hz/60Hz sine wave	50	A
Surge current (Non-Repetitive)		I <sub>FSM</sub>	T <sub>J</sub> =150°C, 10ms	350	A
I <sup>2</sup> t (Non-Repetitive)			T <sub>J</sub> =150°C, 10ms	648	A <sup>2</sup> s
Operating junction temperature	T <sub>J</sub>		+150	°C	
Storage temperature	T <sub>stg</sub>		-40 to +125	°C	
Isolation voltage	V <sub>iso</sub>	AC : 1 min.	AC 2500	V	
Mounting screw torque			1.7 *1	N·m	

\*1 Recommendable value : 1.3 to 1.7 N·m (M4)

● Electrical characteristics (Tj=25°C unless without specified)

Item	Symbol	Condition	Characteristics			Unit	
			Min.	Typ.	Max.		
Inverter (IGBT)	Zero gate voltage collector current	ICES	VCE=600V, VGE=0V			1.0	mA
	Gate-Emitter leakage current	IGES	VCE=0V, VGE=±20V			20	µA
	Gate-Emitter threshold voltage	VGE(th)	VCE=20V, Ic=30mA			4.5	V
	Collector-Emitter saturation voltage	VCE(sat)	VGE=15V, Ic=30A			2.8	V
	Collector-Emitter voltage	-VCE	-Ic=30A			3.0	V
	Input capacitance	Cies	VGE=0V, VCE=10V, f=1MHz			1980	pF
	Switching time	ton	VCC=300V			1.2	µs
		tr	Ic=30A			0.6	µs
		toff	VGE=±15V			1.5	µs
		tf	RG=82 ohm			0.35	µs
Reverse recovery time of FRD	trr	IF=30A, VGE=-10V, -di/dt=100A/µs			300	ns	
Brake (IGBT)	Zero gate voltage collector current	ICES	VCE=600V, VGE=0V			1.0	mA
	Gate-Emitter leakage current	IGES	VCE=0V, VGE=±20V			100	nA
	Collector-Emitter saturation voltage	VCE(sat)	Ic=30A, VGE=15V			2.8	V
	Switching time	ton	VCC=300V			0.8	µs
		tr	Ic=30A			0.6	µs
		toff	VGE=±15V			1.0	µs
		tf	RG=82 ohm			0.35	µs
Brake (FWD)	Reverse current	IRRM	VR=600V			1.0	mA
	Reverse recovery time	trr				600	ns
Converter	Forward voltage	VFM	IF=50A			1.55	V
	Reverse current	IRRM	VR=800V			1.0	mA

● Thermal Characteristics

Item	Symbol	Condition	Characteristics			Unit
			Min.	Typ.	Max.	
Thermal resistance ( 1 device )	Rth(j-c)	Inverter IGBT			1.04	°C/W
		Inverter FRD			2.22	
		Brake IGBT			1.04	
		Converter Diode			2.10	
Contact thermal resistance *	Rth(c-f)	With thermal compound		0.05		

\* This is the value which is defined mounting on the additional cooling fin with thermal compound

■ Equivalent Circuit Schematic

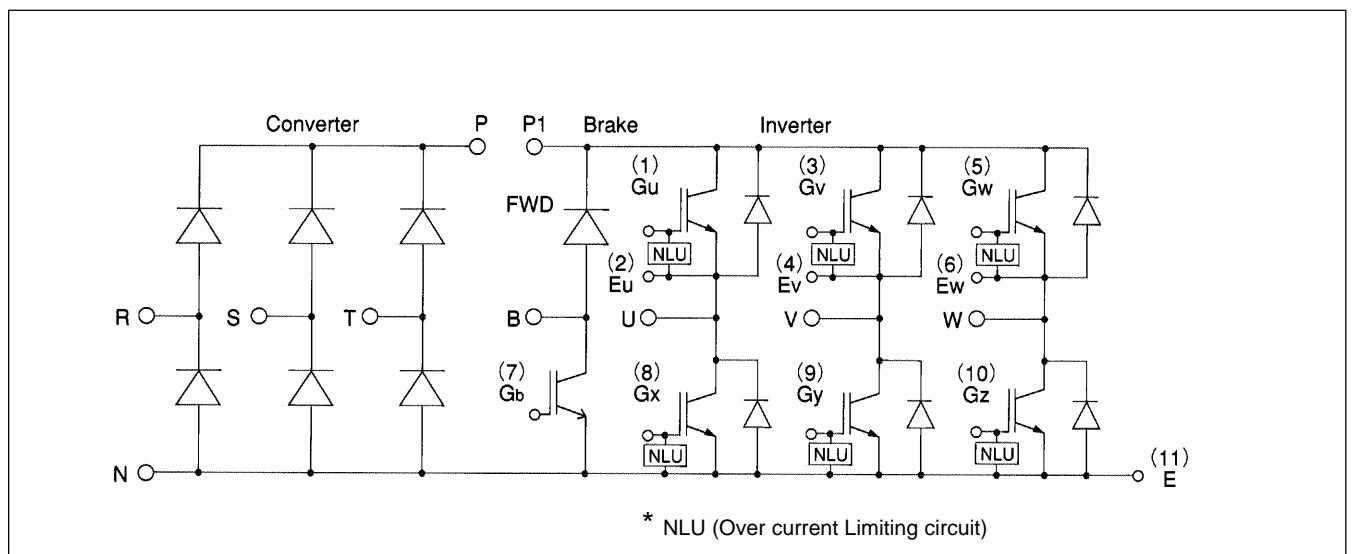

■ Characteristics (Representative)

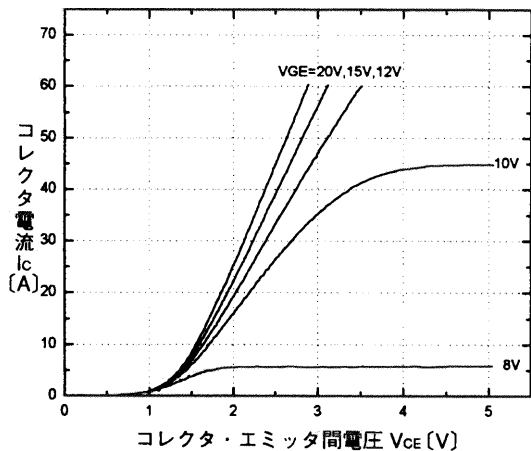

コレクタ電流-コレクタ・エミッタ間電圧特性 ( $T_j = 25^\circ\text{C}$ ) <INV部>  
Collector current vs. Collector-Emitter voltage <INV>

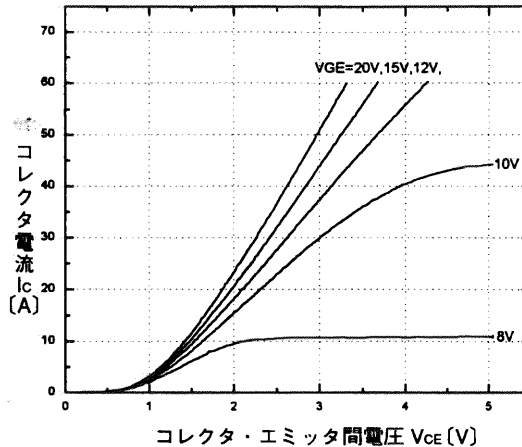

コレクタ電流-コレクタ・エミッタ間電圧特性 ( $T_j = 125^\circ\text{C}$ ) <INV部>  
Collector current vs. Collector-Emitter voltage <INV>

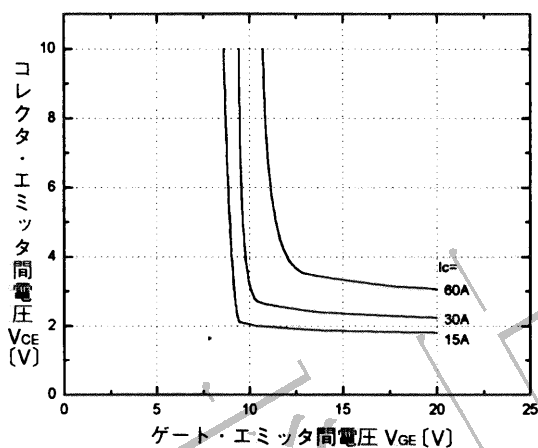

コレクタ・エミッタ間電圧-ゲート・エミッタ間電圧特性 ( $T_j = 25^\circ\text{C}$ ) <INV部>  
Collector-Emitter voltage vs. Gate-Emitter voltage <INV>

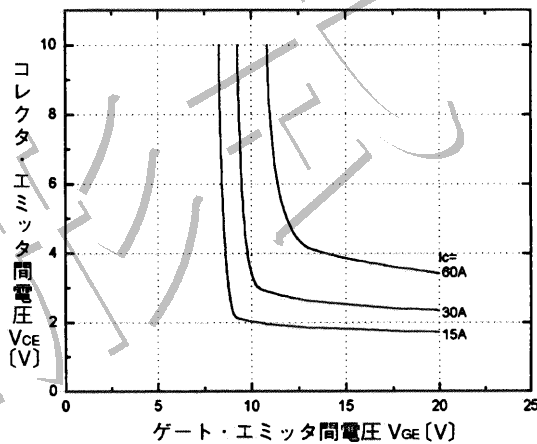

コレクタ・エミッタ間電圧-ゲート・エミッタ間電圧特性 ( $T_j = 125^\circ\text{C}$ ) <INV部>  
Collector-Emitter voltage vs. Gate-Emitter voltage <INV>

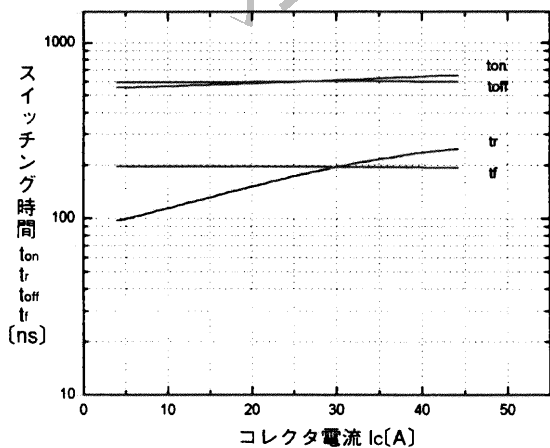

スイッチング時間-コレクタ電流特性 ( $T_j = 25^\circ\text{C}$ ) <INV部>  
Switching time vs. Collector current <INV>

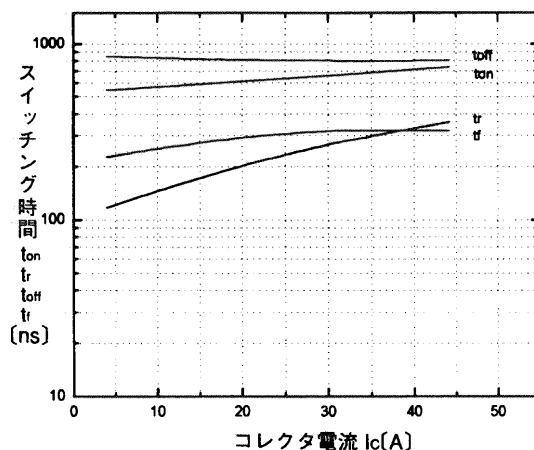

スイッチング時間-コレクタ電流特性 ( $T_j = 125^\circ\text{C}$ ) <INV部>  
Switching time vs. Collector current <INV>

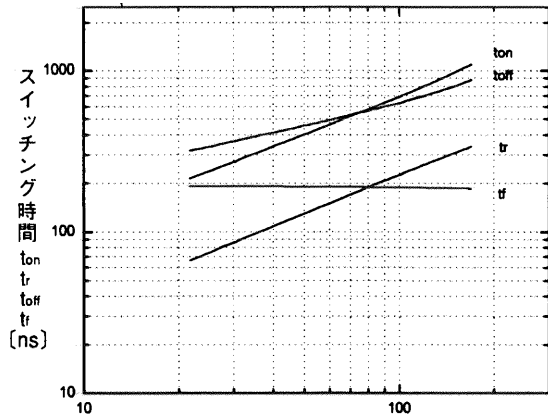

ゲート抵抗  $R_G$  [Ω]  
 スイッチング時間-ゲート抵抗特性 ( $T_j=25^\circ\text{C}$ ) <INV部>  
 Switching time vs. Gate resistance <INV>

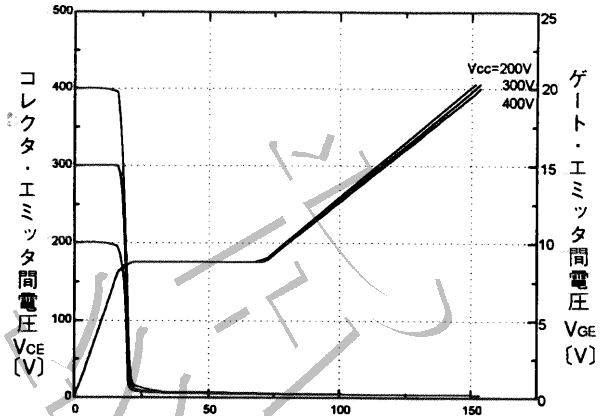

充電電荷量  $Q_g$  [nC]  
 ダイナミック入力特性 ( $T_j=25^\circ\text{C}$ ) <INV部>  
 Dynamic input characteristic <INV>

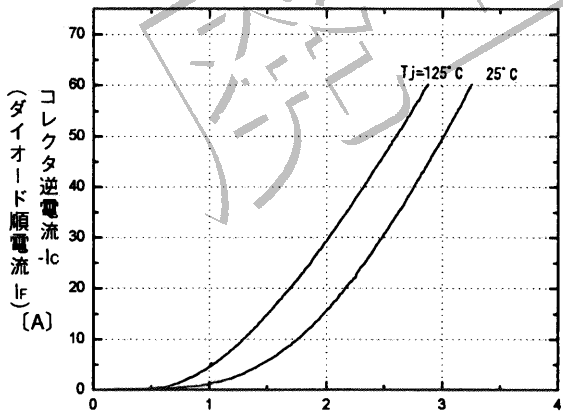

エミッタ・コレクタ間電圧  $V_{ceD}$  [V]  
 (ダイオード順電圧  $V_F$ )  
 高速フリーホイールダイオード順電圧特性 <INV部>  
 Forward voltage of free wheel diode <INV>

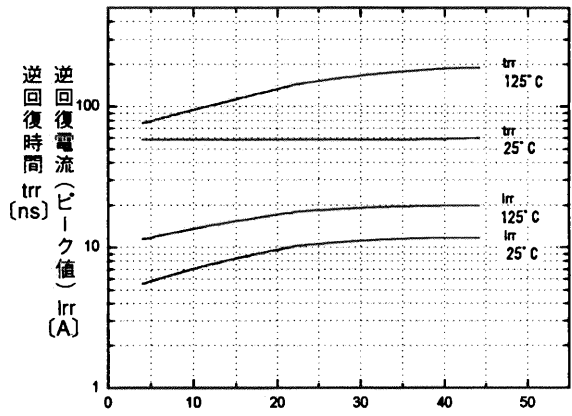

順電流  $I_F$  [A]  
 $T_{rr}$ ,  $I_{rr}$ - $I_F$  特性 <INV部>  
 $T_{rr}$ ,  $I_{rr}$ - $I_F$  <INV>

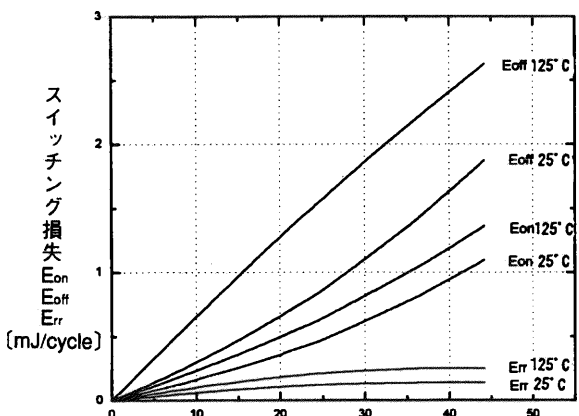

コレクタ電流  $I_c$  [A]  
 スイッチング損失-コレクタ電流特性 <INV部>  
 Switching loss vs. Collector current <INV>

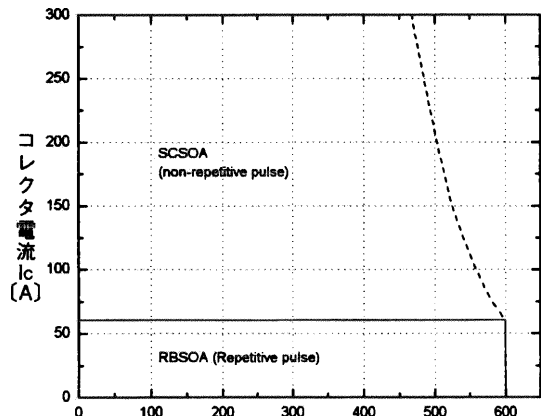

コレクタ・エミッタ間電圧  $V_{ce}$  [V]  
 安全動作領域(逆バイアス) ( $T_j \leq 125^\circ\text{C}$ ) <INV部>  
 Reverse biased safe operating area <INV>

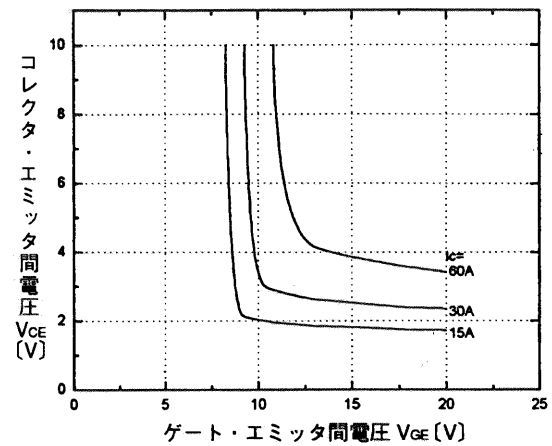
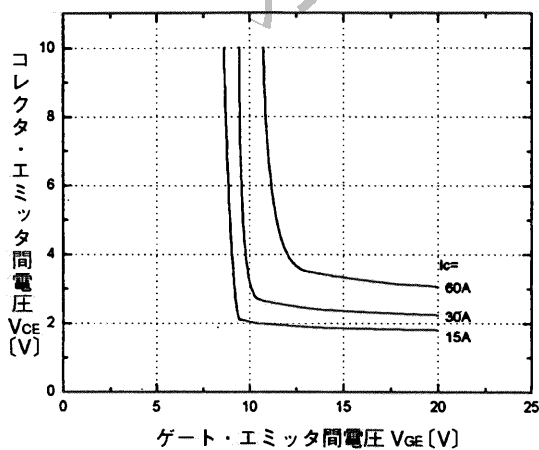
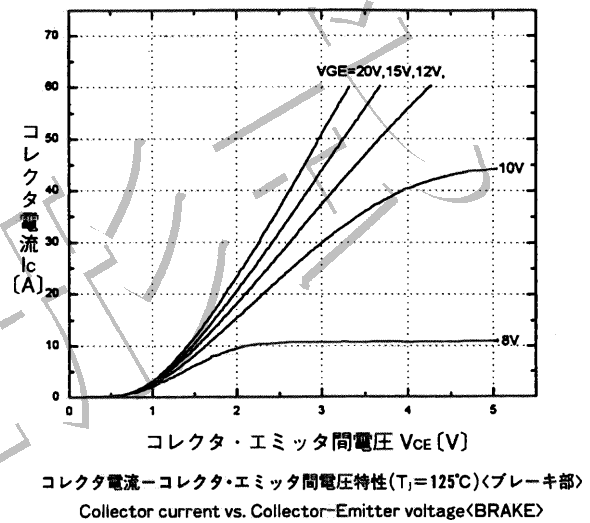
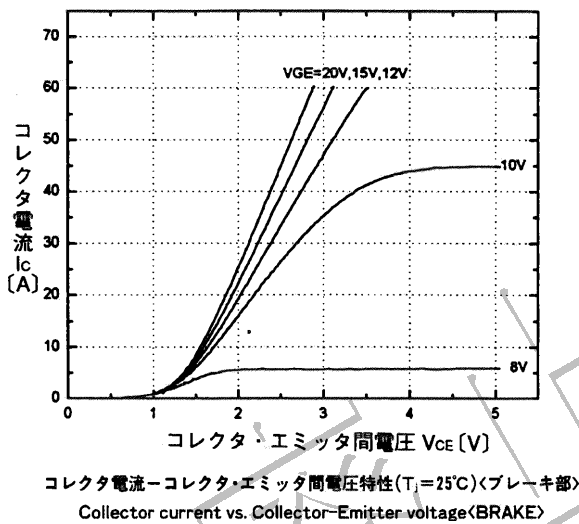
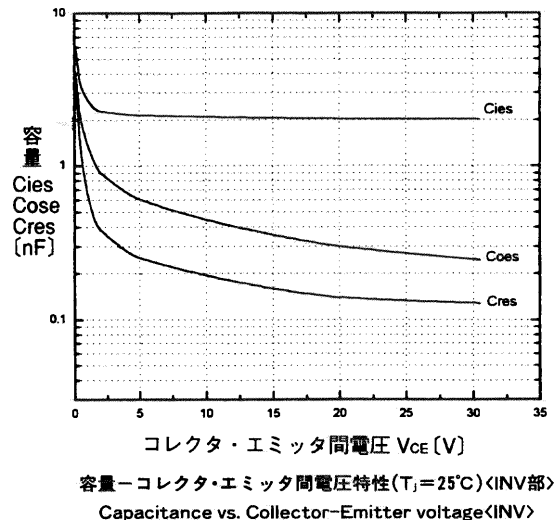
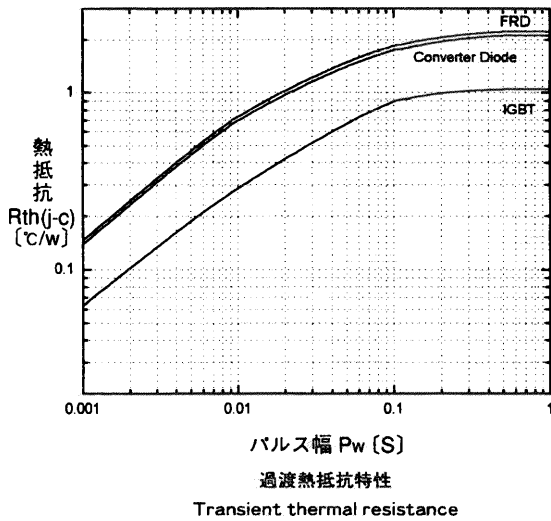

コレクタ・エミッタ間電圧-ゲート・エミッタ間電圧特性 ( $T_j=25^{\circ}C$ ) <ブレーキ部>  
Collector-Emitter voltage vs. Gate-Emitter voltage <BRAKE>

コレクタ・エミッタ間電圧-ゲート・エミッタ間電圧特性 ( $T_j=125^{\circ}C$ ) <ブレーキ部>  
Collector-Emitter voltage vs. Gate-Emitter voltage <BRAKE>

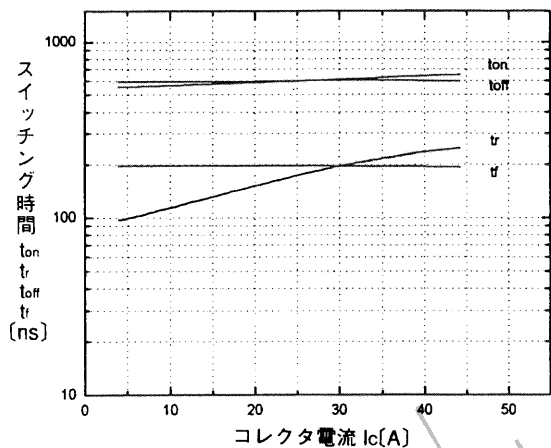

スイッチング時間-コレクタ電流特性 ( $T_j=25^\circ\text{C}$ ) <ブレーキ部>  
Switching time vs. Collector current <BRAKE>

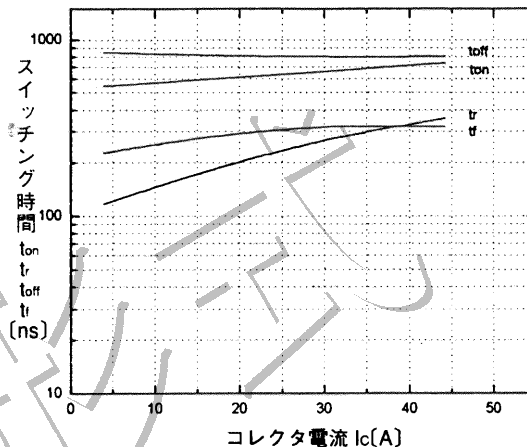

スイッチング時間-コレクタ電流特性 ( $T_j=125^\circ\text{C}$ ) <ブレーキ部>  
Switching time vs. Collector current <BRAKE>

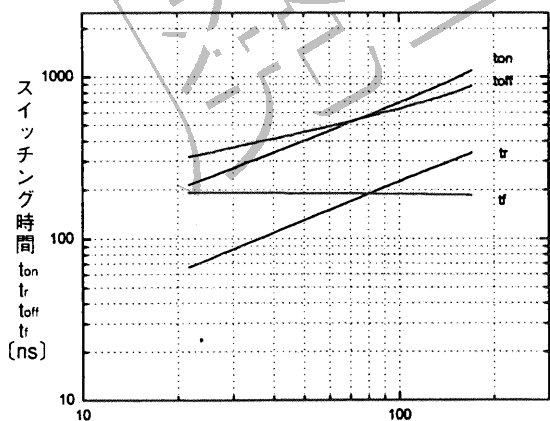

ゲート抵抗  $R_g$  ( $\Omega$ )  
スイッチング時間-ゲート抵抗特性 ( $T_j=25^\circ\text{C}$ ) <ブレーキ部>  
Switching time vs. Gate resistance <BRAKE>

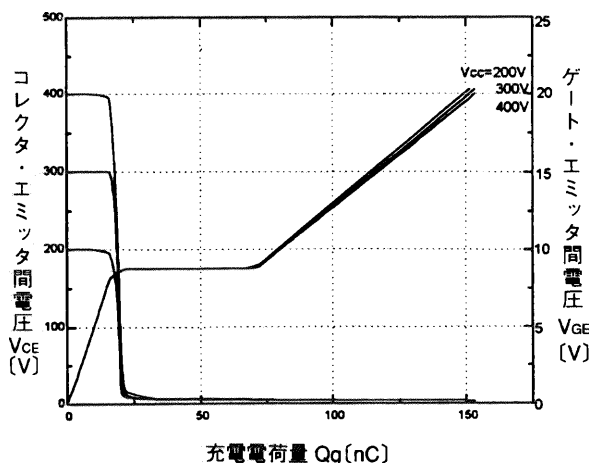

充電電荷量  $Q_g$  (nC)  
ダイナミック入力特性 ( $T_j=25^\circ\text{C}$ ) <ブレーキ部>  
Dynamic input characteristic <BRAKE>

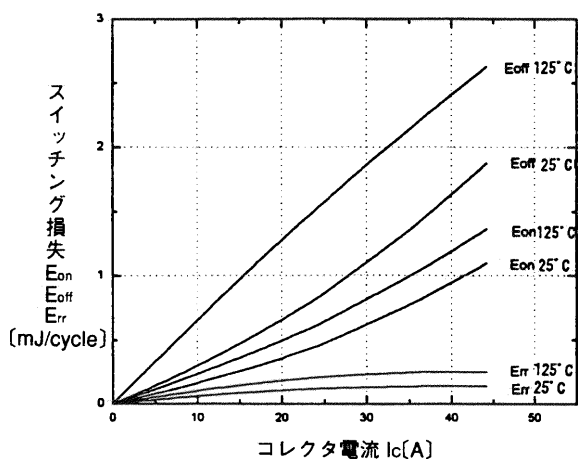

スイッチング損失-コレクタ電流特性 <ブレーキ部>  
Switching loss vs. Collector current <BRAKE>

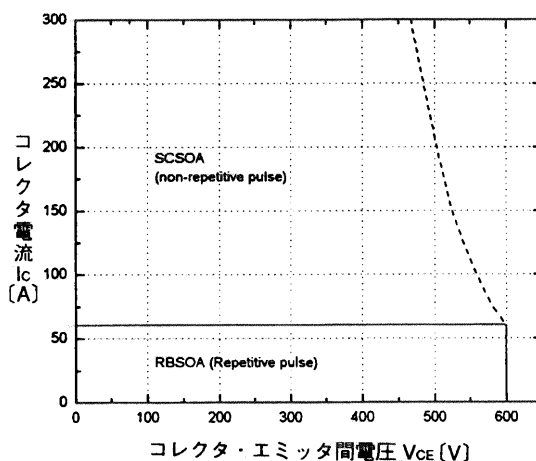

安全動作領域(逆バイアス) ( $T_j \leq 125^\circ\text{C}$ ) <ブレーキ部>  
Reverse biased safe operating area <BRAKE>

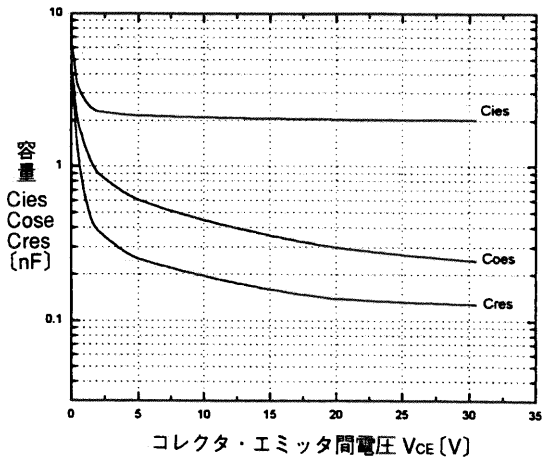

容量-コレクタ・エミッタ間電圧特性(Tj=25°C)〈ブレーキ部〉  
Capacitance vs. Collector-Emitter voltage<BRAKE>

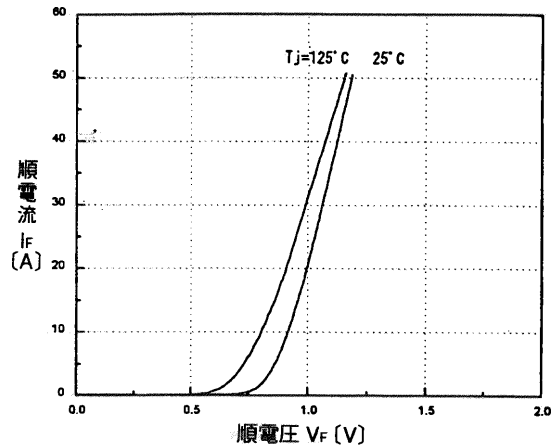

コンバータ部ダイオード順電圧特性  
Converter Diode  
Forward current vs. Forward voltage

■ Outline Drawings, mm

