

IGBT MODULE (U series) 1200V / 35A / PIM



■ Features

- Low $V_{CE(sat)}$
- Compact Package
- P.C. Board Mount Module
- Converter Diode Bridge Dynamic Brake Circuit

■ Applications

- Inverter for Motoe Drive
- AC and DC Servo Drive Amplifier
- Uninterruptible Power Supply

■ Maximum ratings and characteristics

● Absolute maximum ratings ($T_c=25^\circ\text{C}$ unless otherwise specified)

Item	Symbol	Condition	Rating	Unit		
Inverter	Collector-Emitter voltage	V_{CES}	1200	V		
	Gate-Emitter voltage	V_{GES}	± 20	V		
	Collector current	I_c	Continuous	$T_c=25^\circ\text{C}$	35	A
				$T_c=80^\circ\text{C}$	25	
		I_{CP}	1ms	$T_c=25^\circ\text{C}$	70	
				$T_c=80^\circ\text{C}$	50	
	$-I_c$			35		
$-I_c$ pulse	1ms		70			
Collector power dissipation	P_c	1 device	160	W		
Brake	Collector-Emitter voltage	V_{CES}	1200	V		
	Gate-Emitter voltage	V_{GES}	± 20	V		
	Collector current	I_c	Continuous	$T_c=25^\circ\text{C}$	25	A
				$T_c=80^\circ\text{C}$	15	
		I_{CP}	1ms	$T_c=25^\circ\text{C}$	50	
				$T_c=80^\circ\text{C}$	30	
Collector power dissipation	P_c	1 device	115	W		
Repetitive peak reverse voltage	V_{RRM}		1200	V		
Converter	Repetitive peak reverse voltage	V_{RRM}	1600	V		
	Average output current	I_o	50Hz/60Hz sine wave	35	A	
	Surge current (Non-Repetitive)	I_{FSM}	$T_j=150^\circ\text{C}$, 10ms	260	A	
	I^2t (Non-Repetitive)	I^2t	half sine wave		338	A^2s
Operating junction temperature	T_j		+150	$^\circ\text{C}$		
Storage temperature	T_{stg}		-40 to +125	$^\circ\text{C}$		
Isolation voltage	between terminal and copper base *2	V_{iso}	AC : 1 minute	AC 2500	V	
	between thermistor and others *3			AC 2500		
Mounting screw torque			3.5 *1	N·m		

*1 Recommendable value : 2.5 to 3.5 N·m (M5)

*2 All terminals should be connected together when isolation test will be done.

*3 Two thermistor terminals should be connected together, each other terminals should be connected together and shorted to base plate when isolation test will be done.

● Electrical characteristics (T_j=25°C unless otherwise specified)

Item	Symbol	Condition	Characteristics			Unit			
			Min.	Typ.	Max.				
Inverter	Zero gate voltage collector current	ICES	V _{CE} =1200V, V _{GE} =0V		-	1.0	mA		
	Gate-Emitter leakage current	IGES	V _{CE} =0V, V _{GE} =±20V		-	200	nA		
	Gate-Emitter threshold voltage	V _{GE(th)}	V _{CE} =20V, I _C =35mA		4.5	6.5	8.5	V	
	Collector-Emitter saturation voltage	V _{CE(sat)} (terminal)	V _{GE} =15V I _C =35A	T _J =25°C	-	2.25	2.70	V	
				T _J =125°C	-	2.60	-		
		V _{CE(sat)} (chip)		T _J =25°C	-	1.95	2.40		
				T _J =125°C	-	2.30	-		
	Input capacitance	C _{ies}	V _{GE} =0V, V _{CE} =10V, f=1MHz		-	3	-	nF	
	Turn-on time	t _{on}	V _{CC} =600V		-	0.53	1.20	μs	
		t _r	I _C =35A		-	0.43	0.60		
		t _{r(i)}	V _{GE} =±15V		-	0.03	-		
	Turn-off time	t _{off}	R _G = 43 Ω		-	0.37	1.00	μs	
		t _f			-	0.07	0.30		
Forward on voltage	V _F (terminal)	V _{GE} = 0 V I _F =35A	T _J =25°C	-	2.05	2.40	V		
			T _J =125°C	-	2.20	-			
	V _F (chip)		T _J =25°C	-	1.75	2.10			
			T _J =125°C	-	1.90	-			
Reverse recovery time	t _{rr}	I _F =35A		-	-	0.35	μs		
Brake	Zero gate voltage collector current	ICES	V _{CE} =1200V, V _{GE} =0V		-	1.0	mA		
	Gate-Emitter leakage current	IGES	V _{CE} =0V, V _{GE} =±20V		-	200	nA		
	Collector-Emitter saturation voltage	V _{CE(sat)} (terminal)	I _C =25A V _{GE} =15V	T _J =25°C	-	2.40	2.90	V	
				T _J =125°C	-	2.85	-		
		V _{CE(sat)} (chip)		T _J =25°C	-	2.10	2.60		
				T _J =125°C	-	2.55	-		
	Turn-on time	t _{on}	V _{CC} =600V		-	0.53	1.20	μs	
		t _r	I _C =25A		-	0.43	0.60		
	Turn-off time	t _{off}	V _{GE} =±15V		-	0.37	1.00	μs	
		t _f	R _G = 68 Ω		-	0.07	0.30		
	Reverse current	I _{RRM}	V _R =1200V		-	-	1.0	mA	
	Converter	Forward on voltage	V _{FM}	I _F =35 A	terminal	-	1.35	1.70	V
				V _{GE} =0V	chip	-	1.25	-	
Reverse current	I _{RRM}	V _R =1600V		-	-	1.0	mA		
Thermistor	Resistance	R	T=25°C	-	5000	-	Ω		
			T=100°C	465	495	520			
B value	B	T=25/50°C		3305	3375	3450	K		

● Thermal resistance Characteristics

Item	Symbol	Condition	Characteristics			Unit
			Min.	Typ.	Max.	
Thermal resistance (1 device)	R _{th(j-c)}	Inverter IGBT	-	-	0.76	°C/W
		Inverter FWD	-	-	1.19	
		Brake IGBT	-	-	1.07	
		Converter Diode	-	-	0.90	
Contact thermal resistance *	R _{th(c-f)}	With thermal compound	-	0.05	-	

* This is the value which is defined mounting on the additional cooling fin with thermal compound

■ Equivalent Circuit Schematic

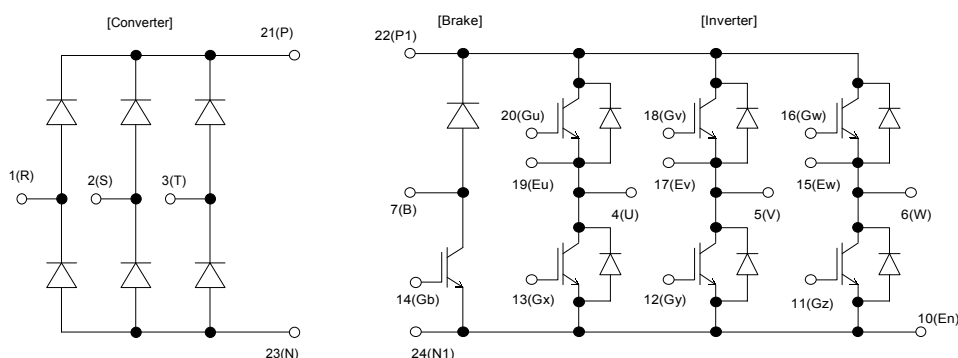

■ Characteristics (Representative)

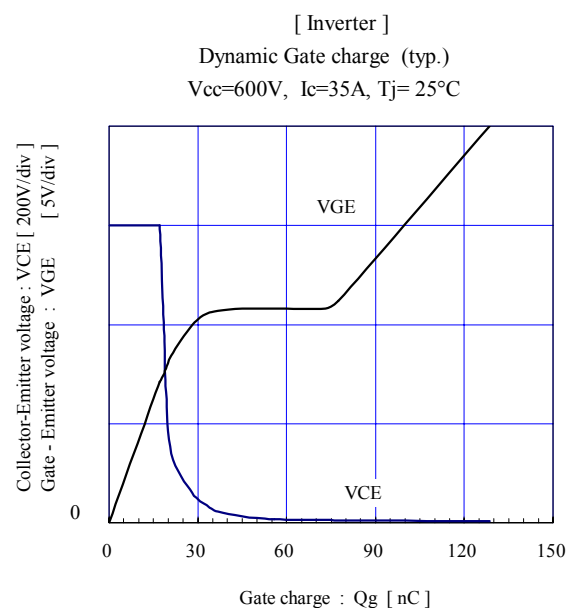
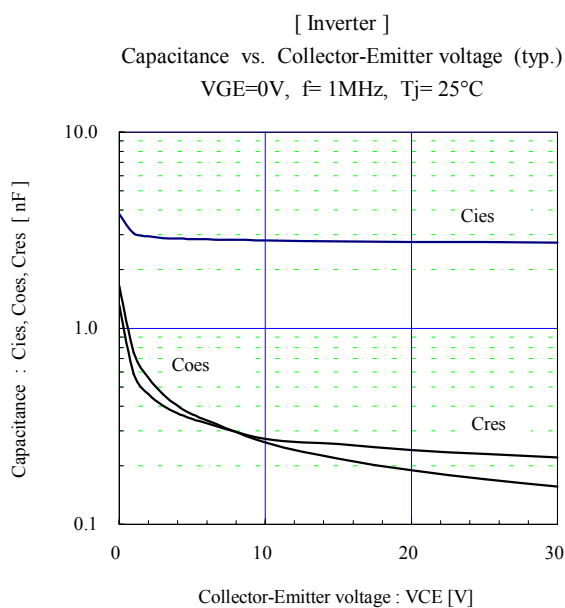
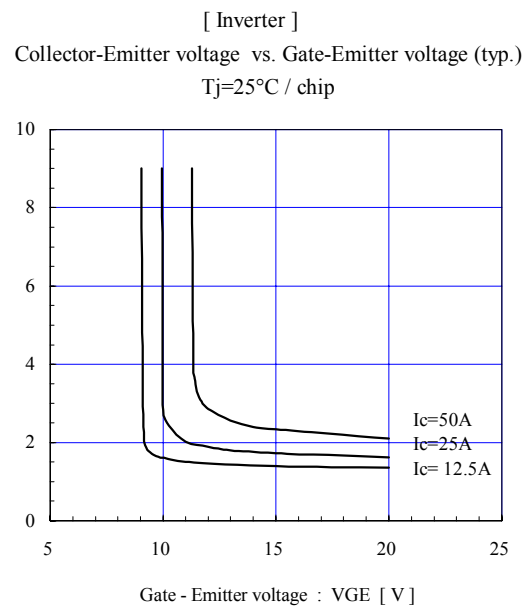
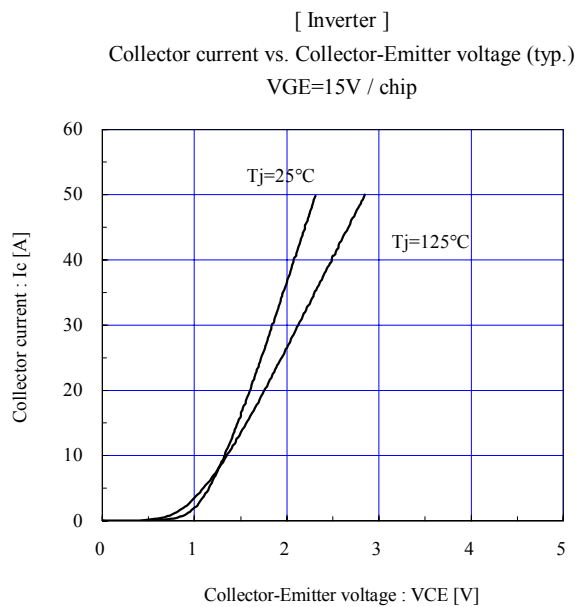
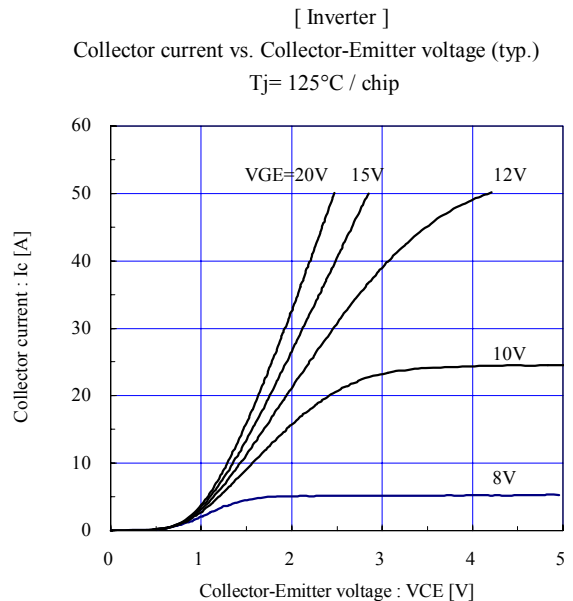
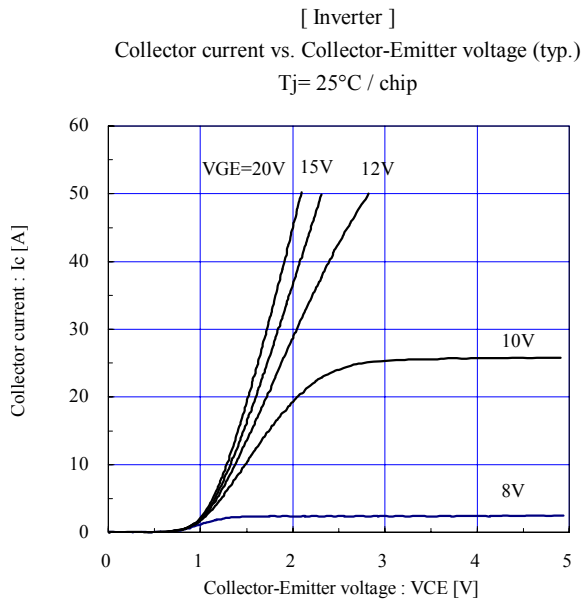

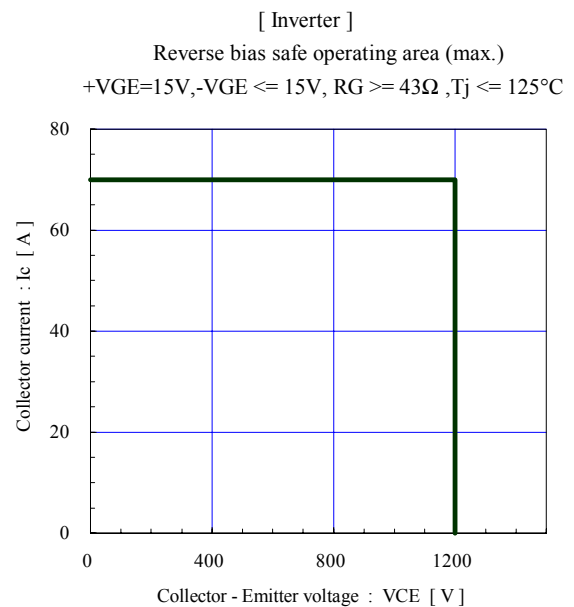
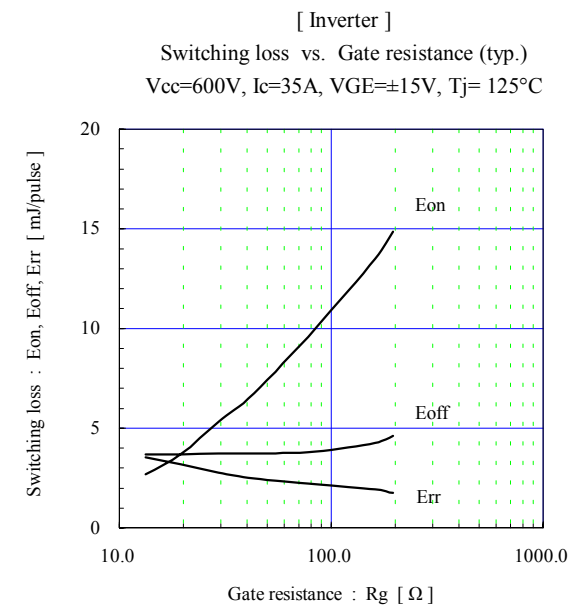
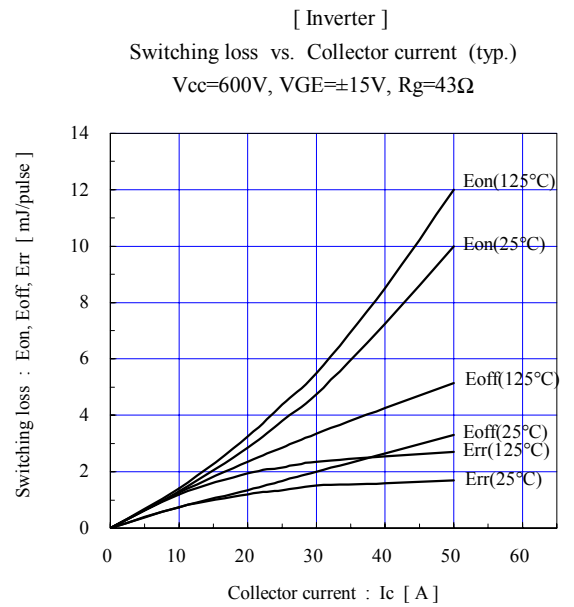
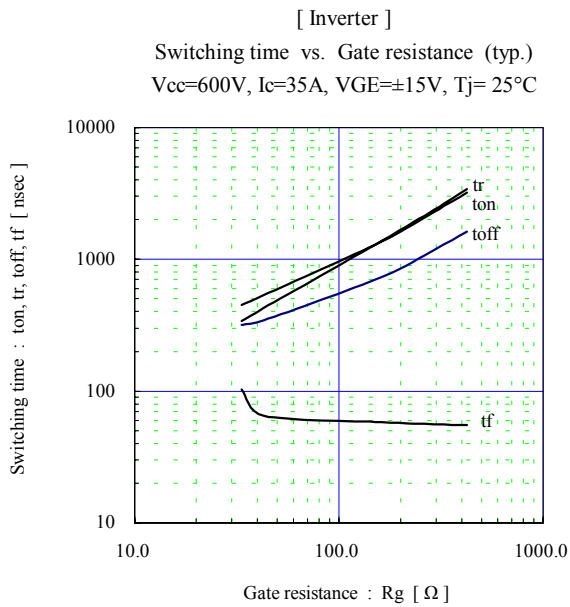
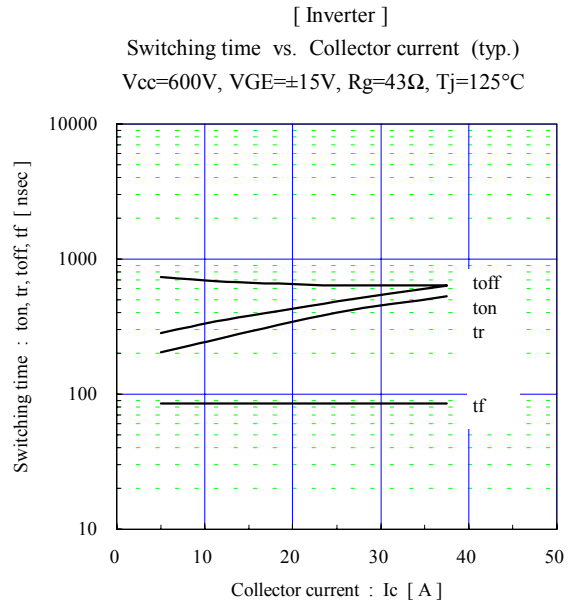
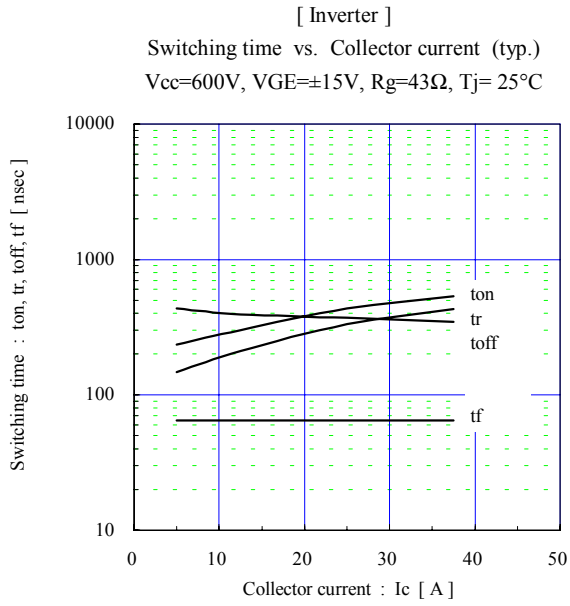

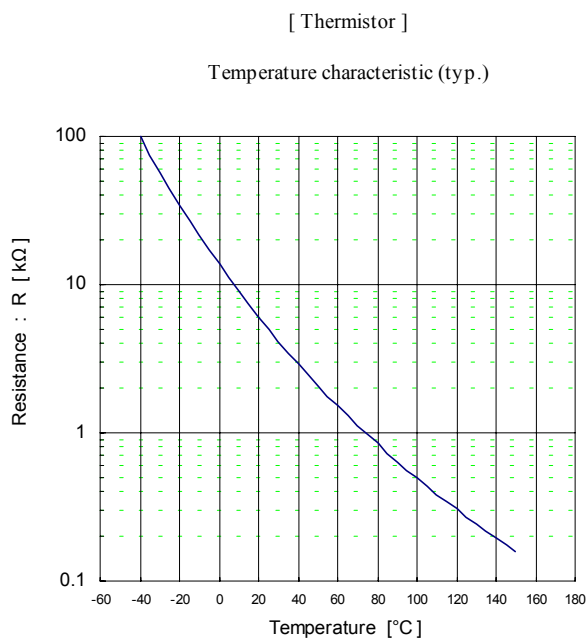
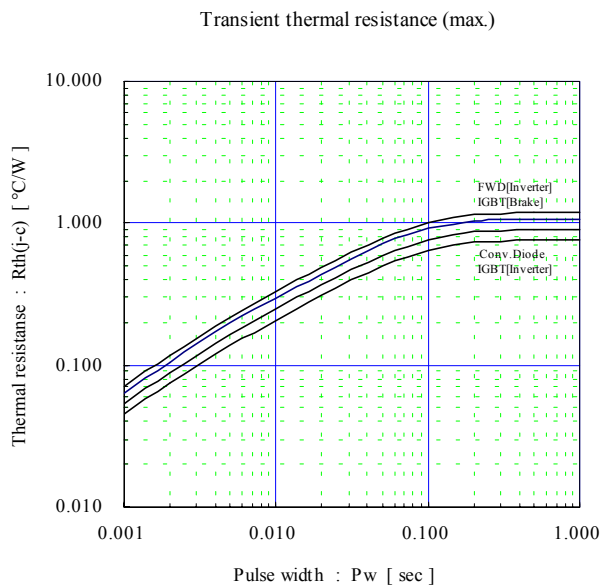
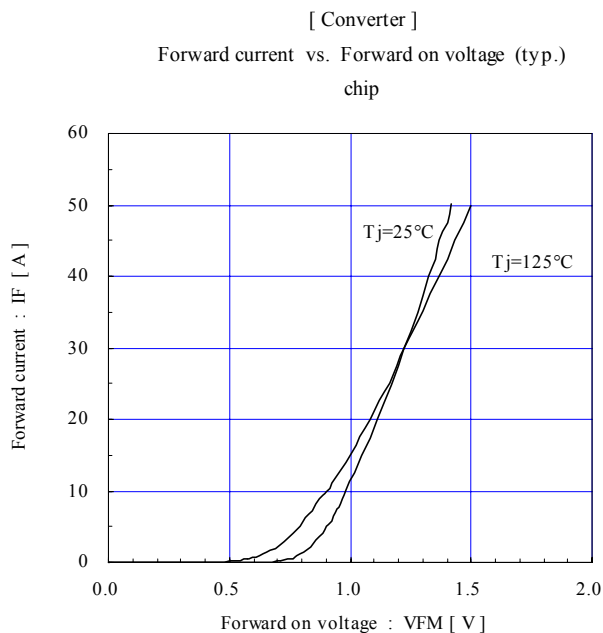
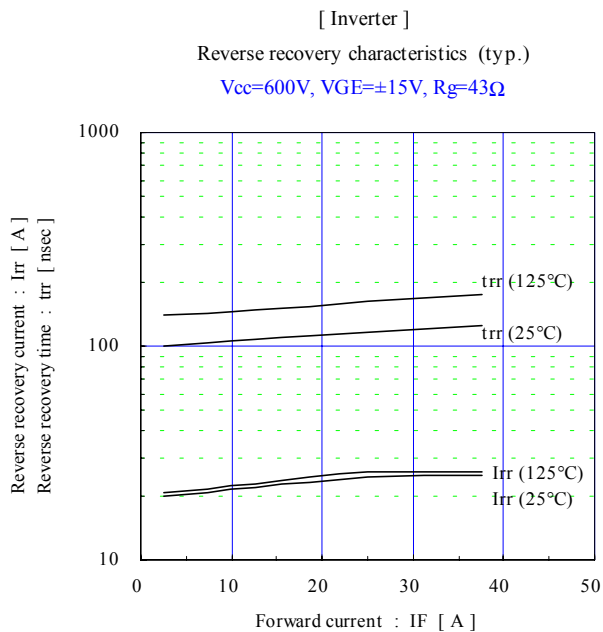
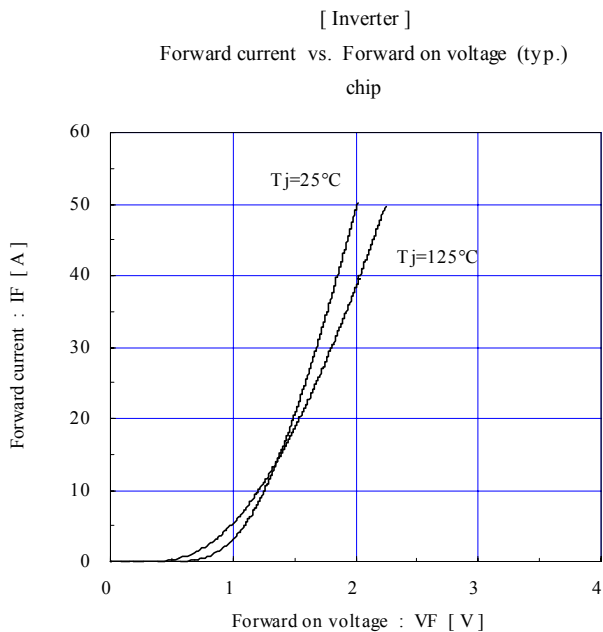

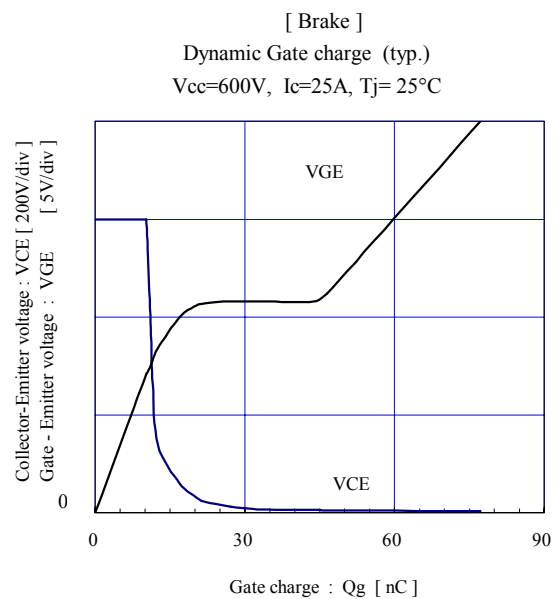
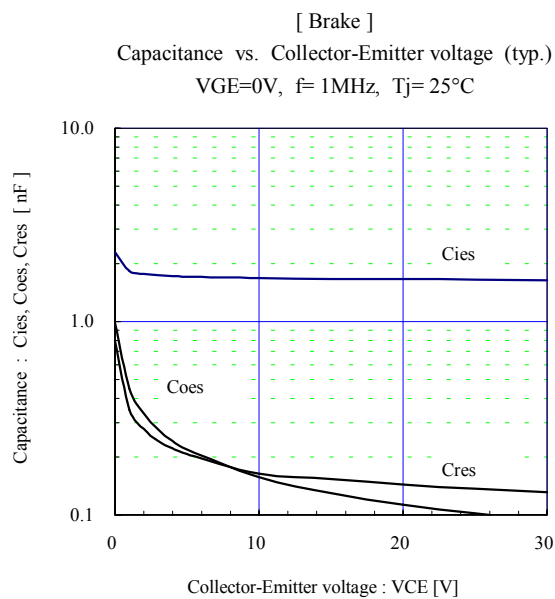
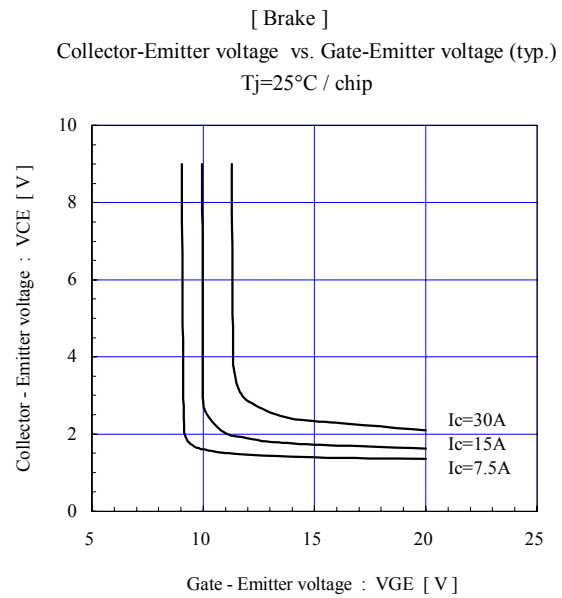
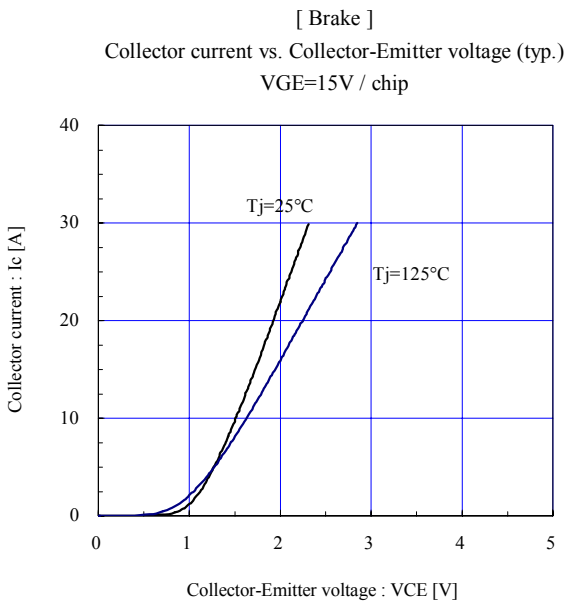
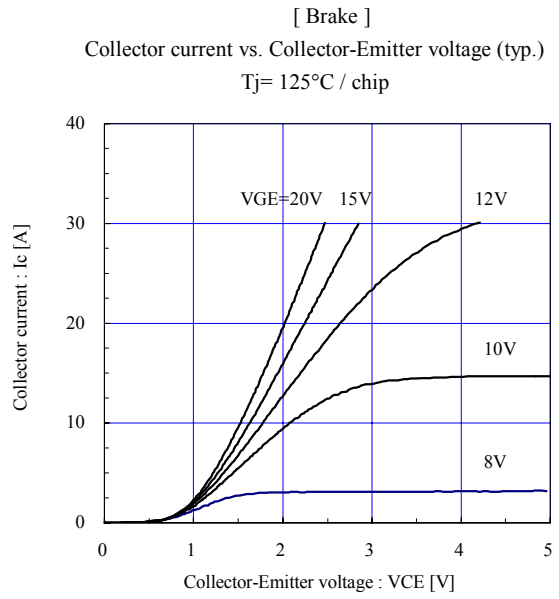
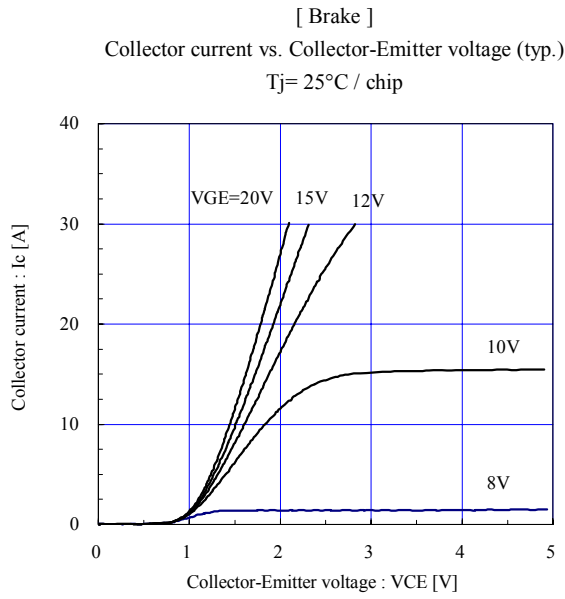

■ Outline Drawings, mm

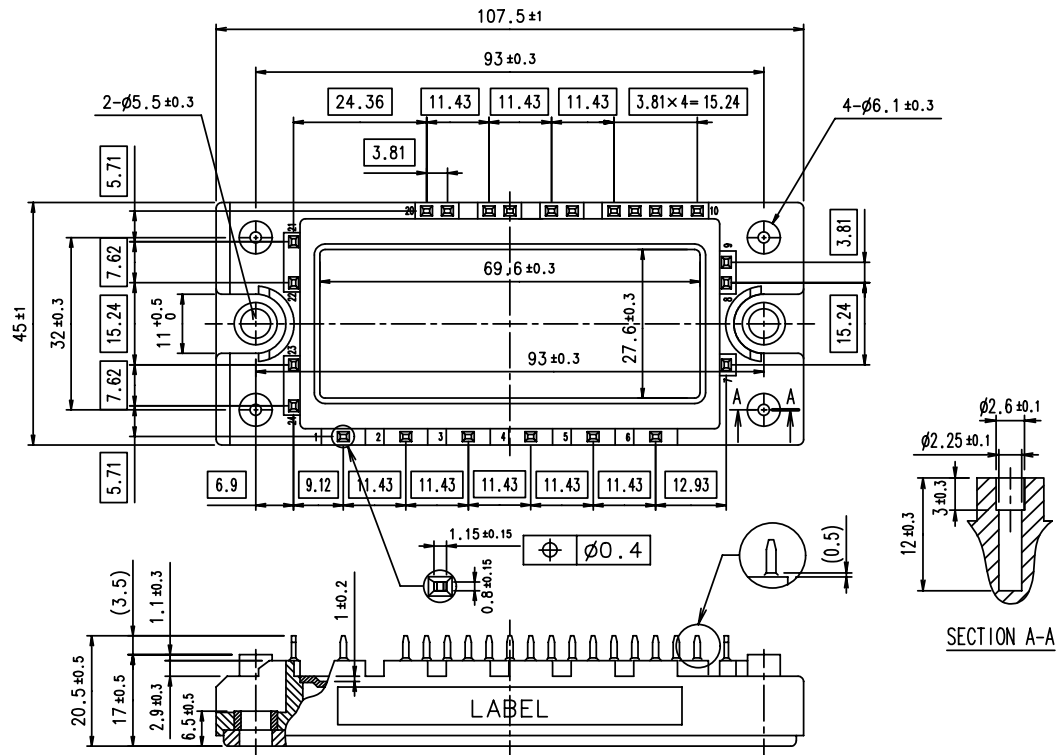

□ shows theoretical dimension.
 () shows reference dimension.