

### IGBT MODULE (U series) 600V / 50A / PIM



#### ■ Features

- Low  $V_{CE(sat)}$
- Compact Package
- P.C. Board Mount Module
- Converter Diode Bridge Dynamic Brake Circuit

#### ■ Applications

- Inverter for Motoe Drive
- AC and DC Servo Drive Amplifier
- Uninterruptible Power Supply

#### ■ Maximum ratings and characteristics

● Absolute maximum ratings ( $T_c=25^{\circ}\text{C}$  unless otherwise specified)

Item	Symbol	Condition	Rating	Unit	
Inverter	Collector-Emitter voltage	$V_{CES}$	600	V	
	Gate-Emitter voltage	$V_{GES}$	$\pm 20$	V	
	Collector current	$I_C$	Continuous	50	A
		$I_{CP}$	1ms	100	
		$-I_C$		50	
		$-I_C$ pulse	1ms	100	
Collector power dissipation	$P_C$	1 device	187	W	
Brake	Collector-Emitter voltage	$V_{CES}$	600	V	
	Gate-Emitter voltage	$V_{GES}$	$\pm 20$	V	
	Collector current	$I_C$	Continuous	20	A
		$I_{CP}$	1ms	40	A
	Collector power dissipation	$P_C$	1 device	104	W
	Repetitive peak reverse voltage	$V_{RRM}$		600	V
Converter	Repetitive peak reverse voltage	$V_{RRM}$	800	V	
	Average output current	$I_o$	50Hz/60Hz sine wave	50	A
	Surge current (Non-Repetitive)	$I_{FSM}$	$T_j=150^{\circ}\text{C}$ , 10ms	350	A
	$I^2t$ (Non-Repetitive)	$I^2t$	half sine wave	613	$\text{A}^2\text{s}$
Operating junction temperature	$T_j$		+150	$^{\circ}\text{C}$	
Storage temperature	$T_{stg}$		-40 to +125	$^{\circ}\text{C}$	
Isolation voltage	$V_{iso}$	AC : 1 minute	between terminal and copper base *2	AC 2500	V
			between thermistor and others *3	AC 2500	
Mounting screw torque			3.5 *1	N·m	

\*1 Recommendable value : 2.5 to 3.5 N·m (M5)

\*2 All terminals should be connected together when isolation test will be done.

\*3 Two thermistor terminals should be connected together, each other terminals should be connected together and shorted to base plate when isolation test will be done.

## ● Electrical characteristics (T<sub>j</sub>=25°C unless otherwise specified)

Item	Symbol	Condition	Characteristics			Unit		
			Min.	Typ.	Max.			
Inverter	Zero gate voltage collector current	ICES	V <sub>CE</sub> =600V, V <sub>GE</sub> =0V		-	1.0	mA	
	Gate-Emitter leakage current	IGES	V <sub>CE</sub> =0V, V <sub>GE</sub> =±20V		-	200	nA	
	Gate-Emitter threshold voltage	V <sub>GE(th)</sub>	V <sub>CE</sub> =20V, I <sub>C</sub> =50mA		6.2	6.7	7.7	V
	Collector-Emitter saturation voltage	V <sub>CE(sat)</sub> (terminal)	V <sub>GE</sub> =15V I <sub>C</sub> =50A	T <sub>J</sub> =25°C	-	2.25	2.55	V
				T <sub>J</sub> =125°C	-	2.45	-	
		V <sub>CE(sat)</sub> (chip)		T <sub>J</sub> =25°C	-	1.85	-	
				T <sub>J</sub> =125°C	-	2.15	-	
	Input capacitance	C <sub>ies</sub>	V <sub>GE</sub> =0V, V <sub>CE</sub> =10V, f=1MHz		-	3.6	-	nF
	Turn-on time	t <sub>on</sub>	V <sub>CC</sub> =300V		-	0.42	1.20	μs
		t <sub>r</sub>	I <sub>C</sub> =50A		-	0.24	0.60	
		t <sub>r(i)</sub>	V <sub>GE</sub> =±15V		-	0.05	-	
	Turn-off time	t <sub>off</sub>	R <sub>G</sub> =68Ω		-	0.42	1.20	μs
t <sub>f</sub>				-	0.03	0.45		
Forward on voltage	V <sub>F</sub> (terminal)	V <sub>GE</sub> =0V I <sub>F</sub> =50A	T <sub>J</sub> =25°C	-	2.00	2.35	V	
			T <sub>J</sub> =125°C	-	2.05	-		
	V <sub>F</sub> (chip)		T <sub>J</sub> =25°C	-	1.60	-		
			T <sub>J</sub> =125°C	-	1.65	-		
Reverse recovery time	t <sub>rr</sub>	I <sub>F</sub> =50A		-	-	0.35	μs	
Brake	Zero gate voltage collector current	ICES	V <sub>CE</sub> =600V, V <sub>GE</sub> =0V		-	1.0	mA	
	Gate-Emitter leakage current	IGES	V <sub>CE</sub> =0V, V <sub>GE</sub> =±20V		-	200	nA	
	Collector-Emitter saturation voltage	V <sub>CE(sat)</sub> (terminal)	I <sub>C</sub> =20A V <sub>GE</sub> =15V	T <sub>J</sub> =25°C	-	1.85	2.15	V
				T <sub>J</sub> =125°C	-	2.15	-	
		V <sub>CE(sat)</sub> (chip)		T <sub>J</sub> =25°C	-	1.70	-	
				T <sub>J</sub> =125°C	-	2.00	-	
	Turn-on time	t <sub>on</sub>	V <sub>CC</sub> =300V		-	0.45	1.20	μs
		t <sub>r</sub>	I <sub>C</sub> =20A		-	0.15	0.60	
	Turn-off time	t <sub>off</sub>	V <sub>GE</sub> =±15V		-	0.37	1.20	μs
		t <sub>f</sub>	R <sub>G</sub> =270Ω		-	0.04	0.45	
	Reverse current	I <sub>RRM</sub>	V <sub>R</sub> =600V		-	-	1.0	mA
	Converter	Forward on voltage	V <sub>FM</sub>	I <sub>F</sub> =50A	terminal	-	1.20	1.50
V <sub>GE</sub> =0V				chip	-	1.10	-	
Reverse current	I <sub>RRM</sub>	V <sub>R</sub> =800V		-	-	1.0	mA	
Thermistor	Resistance	R	T=25°C	-	5000	-	Ω	
			T=100°C	465	495	520		
B value	B	T=25/50°C		3305	3375	3450	K	

## ● Thermal resistance Characteristics

Item	Symbol	Condition	Characteristics			Unit
			Min.	Typ.	Max.	
Thermal resistance ( 1 device )	R <sub>th(j-c)</sub>	Inverter IGBT	-	-	0.67	°C/W
		Inverter FWD	-	-	1.10	
		Brake IGBT	-	-	1.20	
		Converter Diode	-	-	0.82	
Contact thermal resistance *	R <sub>th(c-f)</sub>	With thermal compound	-	0.05	-	

\* This is the value which is defined mounting on the additional cooling fin with thermal compound

## ■ Equivalent Circuit Schematic

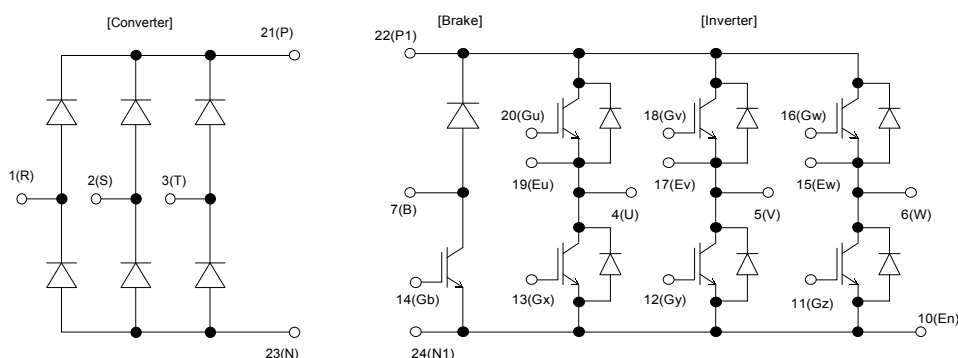

■ Characteristics (Representative)

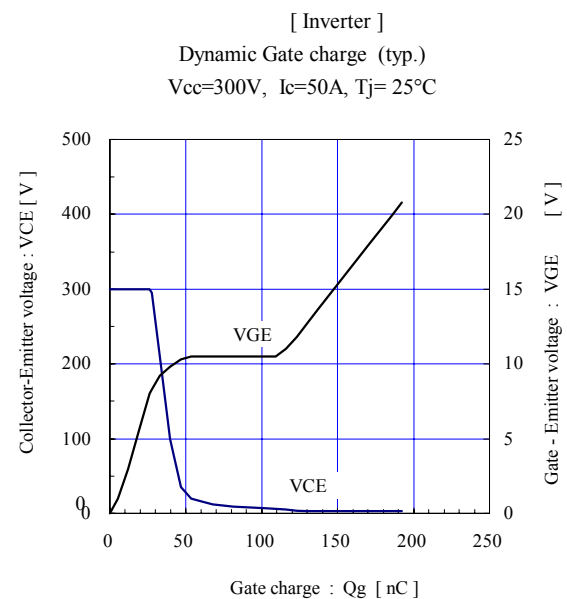
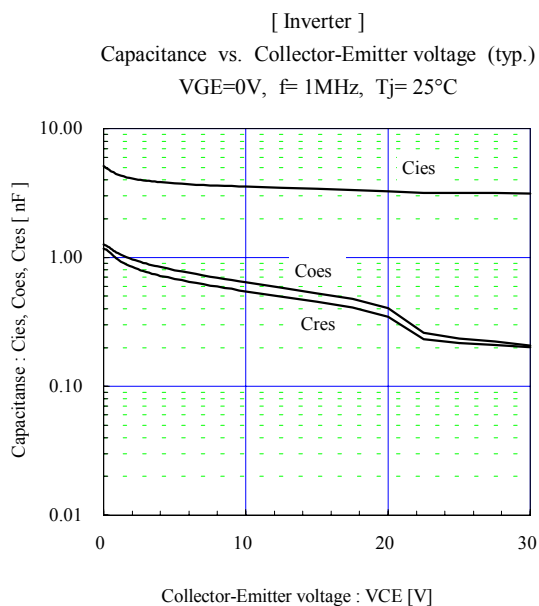
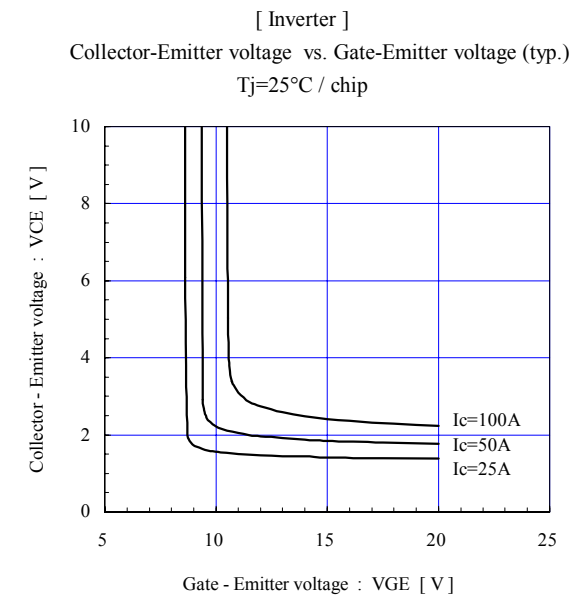
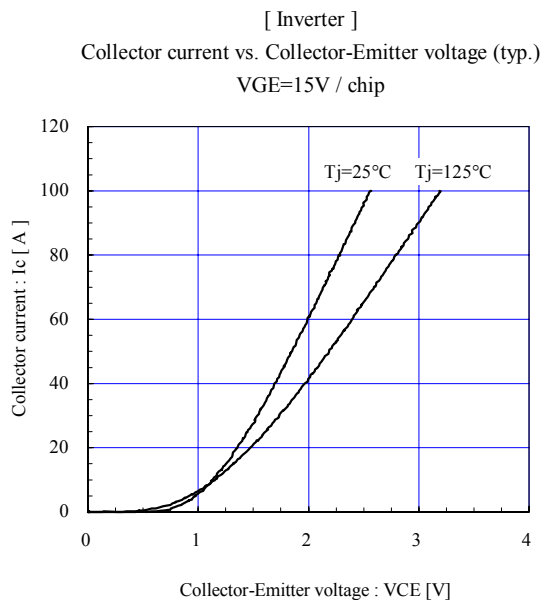
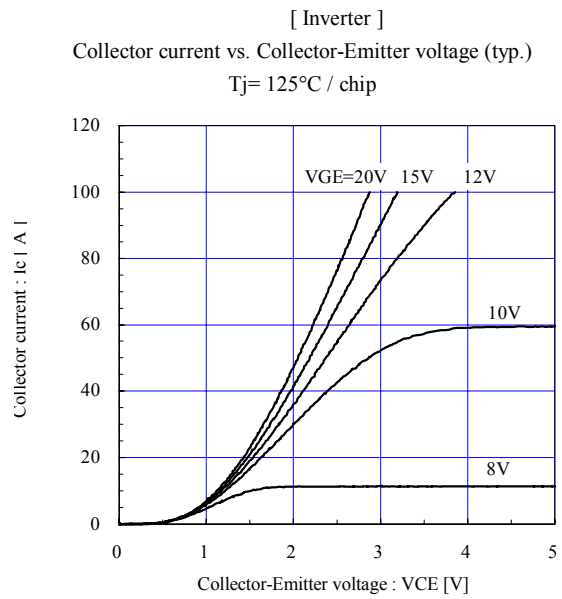
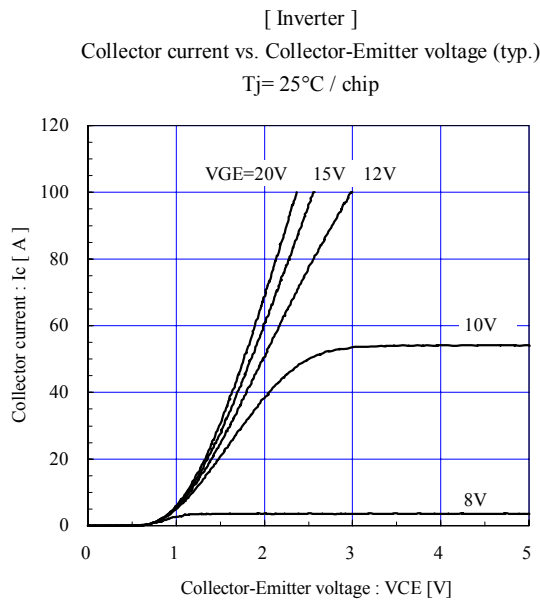

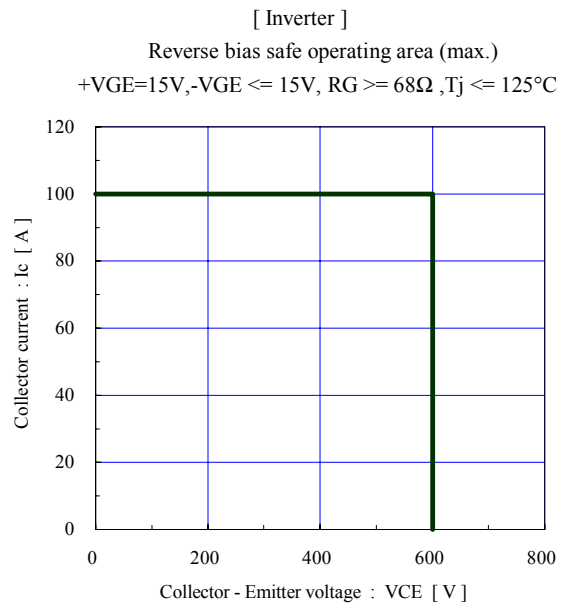
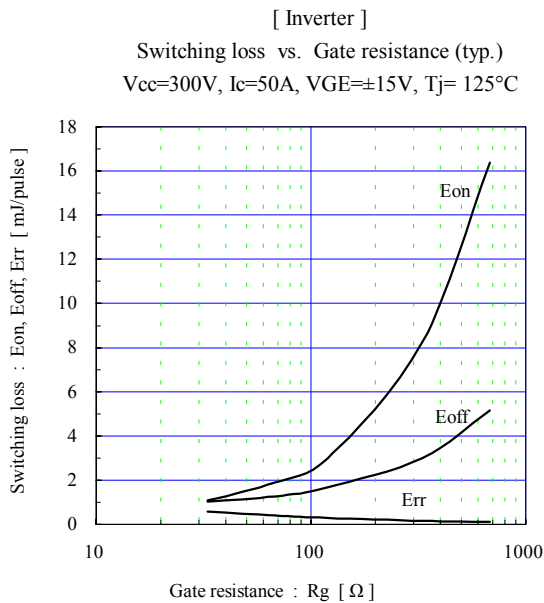
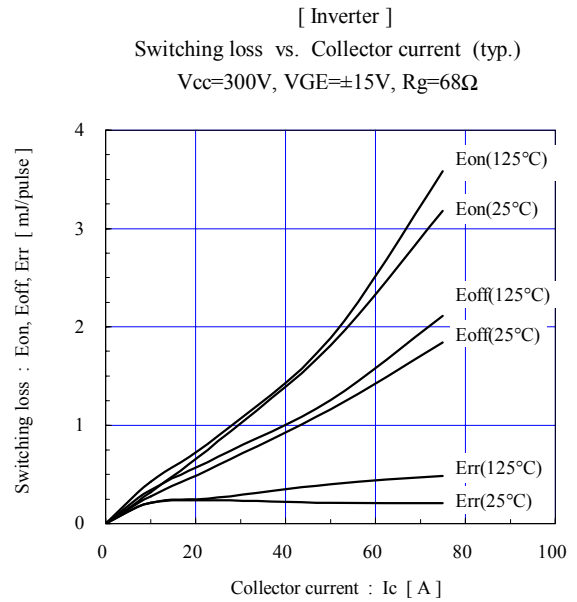
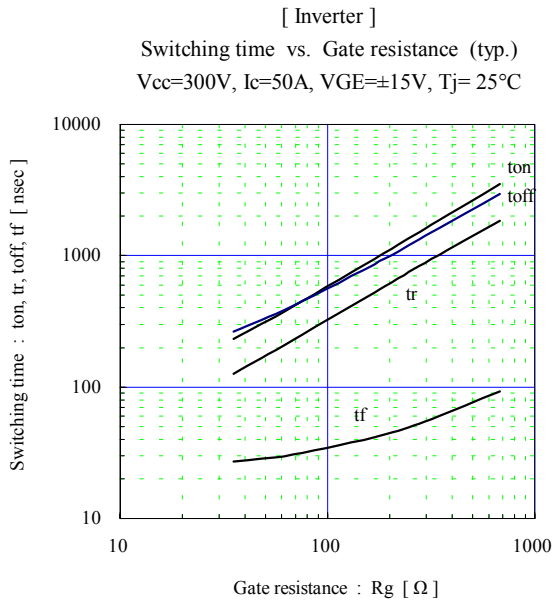
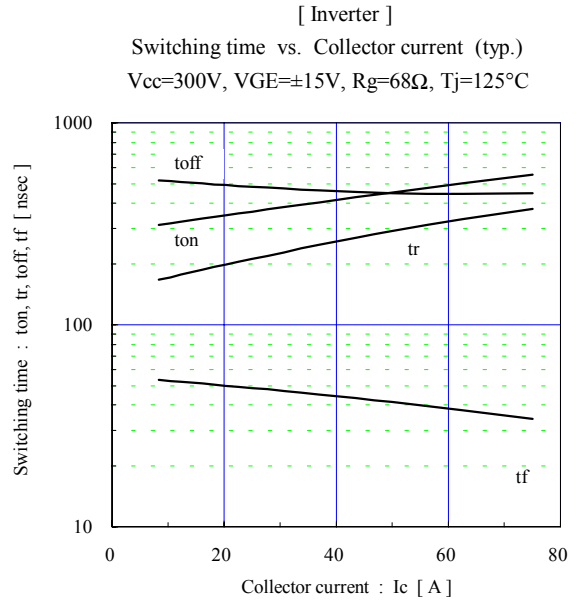
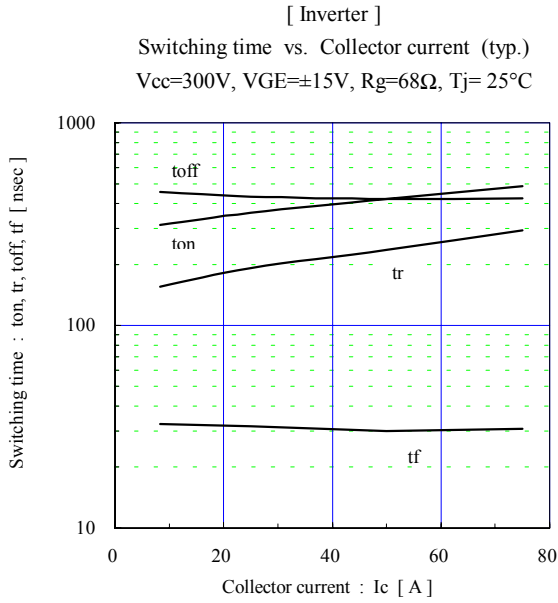

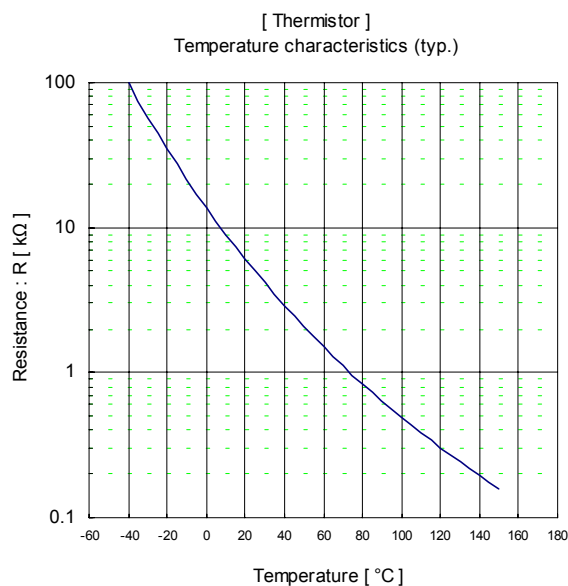
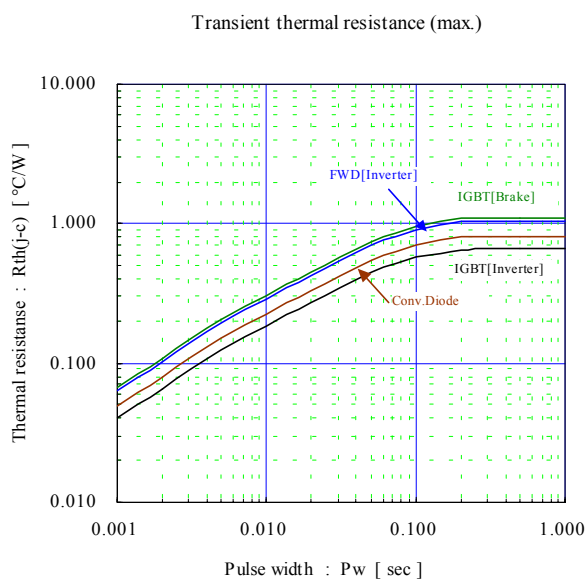
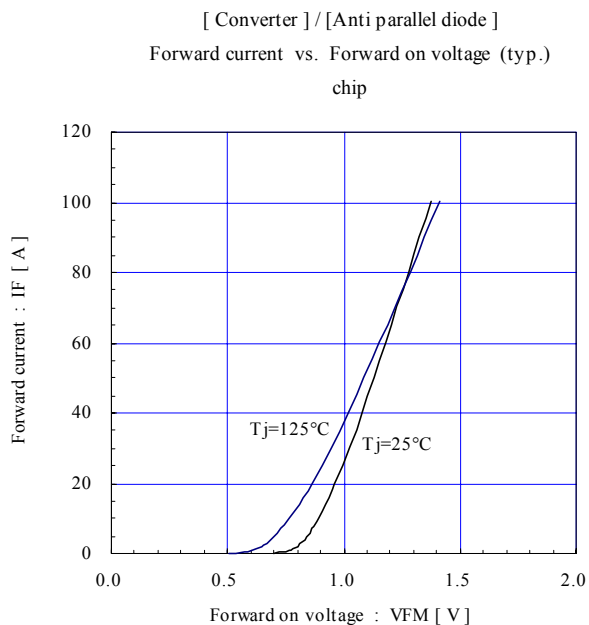
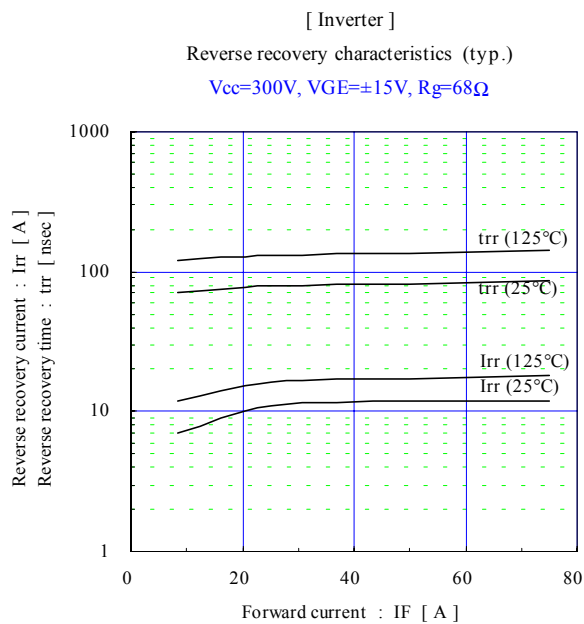
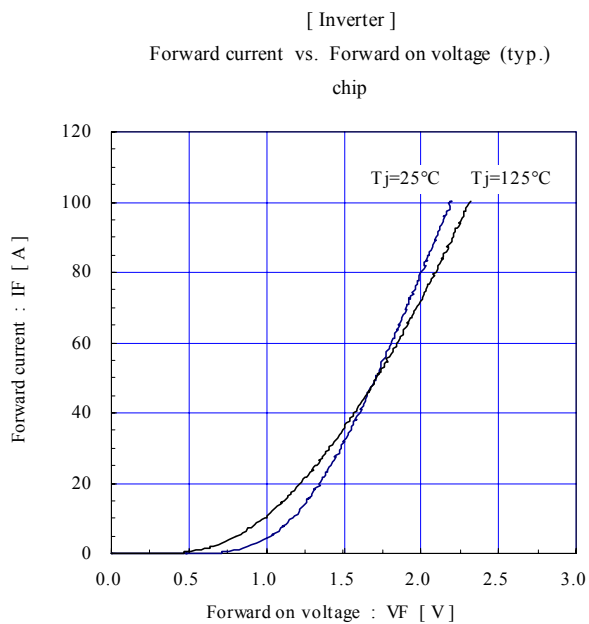

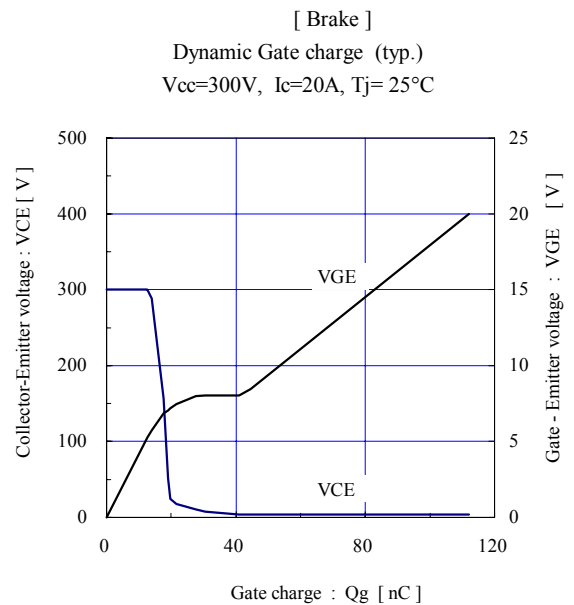
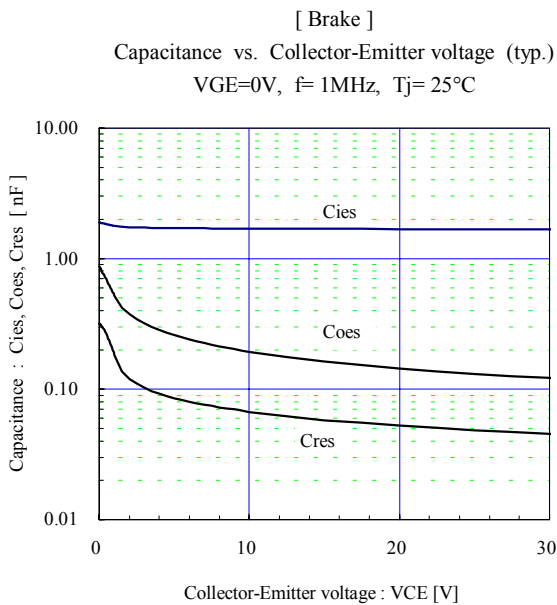
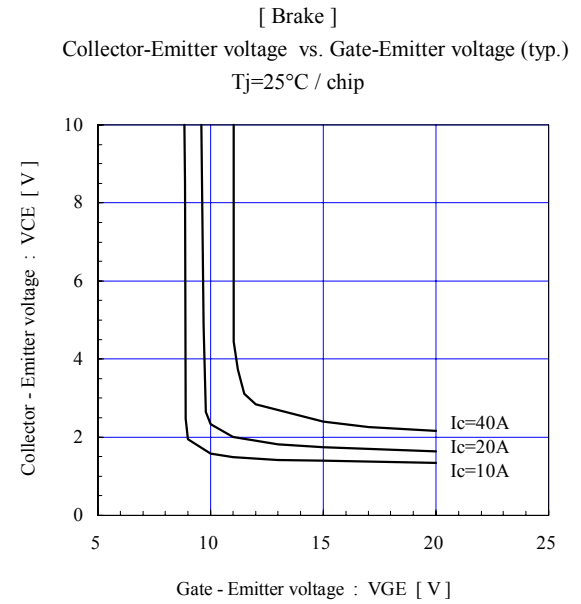
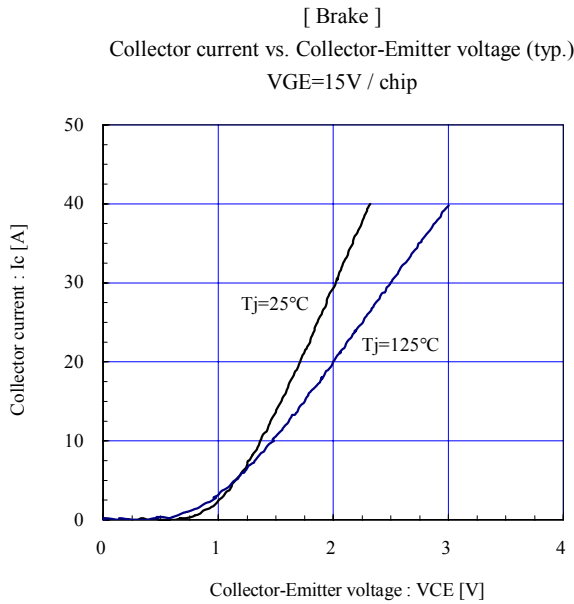
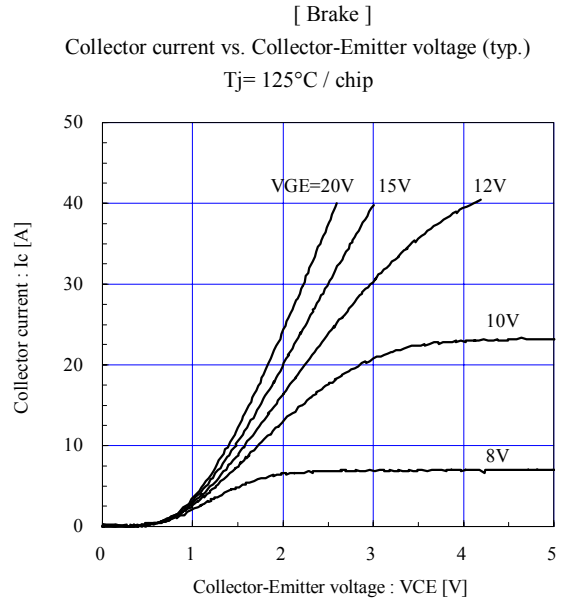
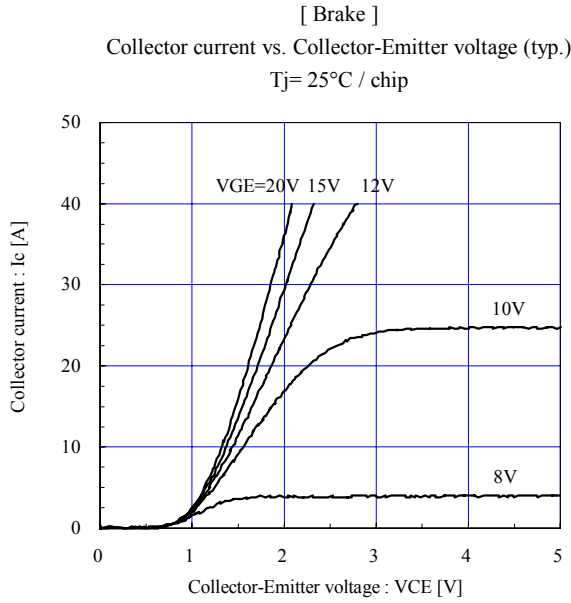

■ Outline Drawings, mm

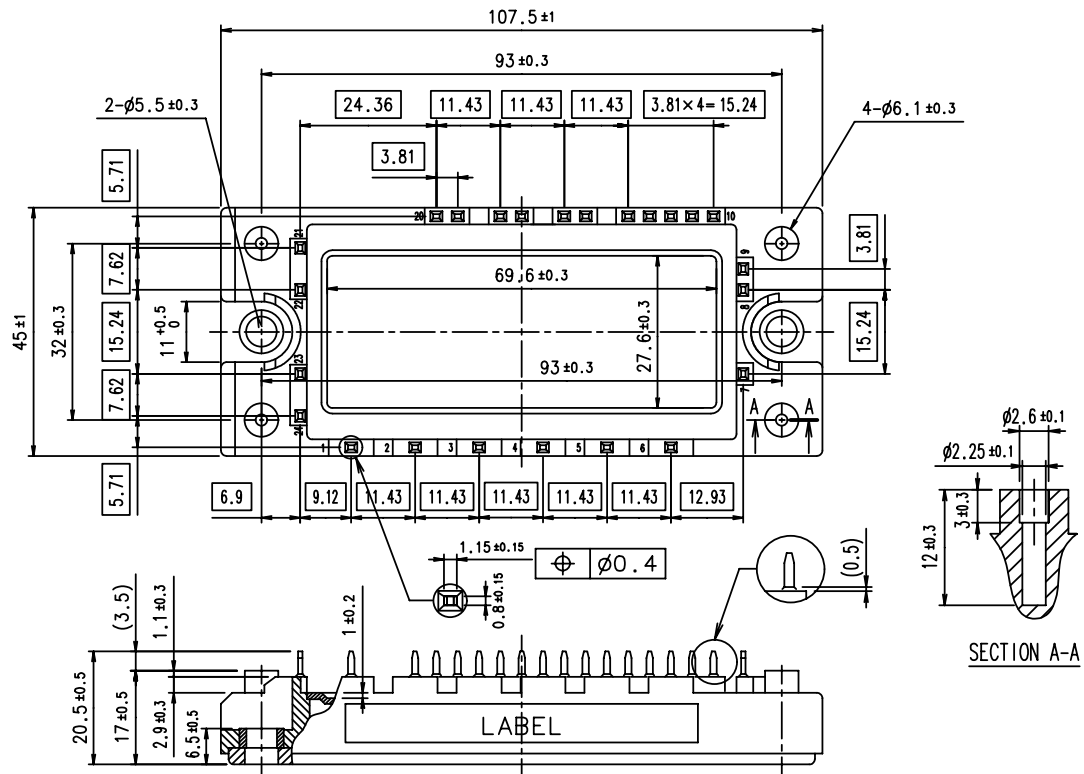

shows theoretical dimension.  
 ( ) shows reference dimension.