

# 7MBR50UA120

IGBT Modules

## IGBT MODULE (U series) 1200V / 50A / PIM



### ■ Features

- Low  $V_{CE(sat)}$
- Compact Package
- P.C. Board Mount Module
- Converter Diode Bridge Dynamic Brake Circuit

### ■ Applications

- Inverter for Motoe Drive
- AC and DC Servo Drive Amplifier
- Uninterruptible Power Supply

### ■ Maximum ratings and characteristics

#### ● Absolute maximum ratings ( $T_c=25^{\circ}\text{C}$ unless otherwise specified)

Item	Symbol	Condition	Rating	Unit		
Inverter	Collector-Emitter voltage	$V_{CES}$	1200	V		
	Gate-Emitter voltage	$V_{GES}$	$\pm 20$	V		
	Collector current	$I_c$	Continuous	$T_c=25^{\circ}\text{C}$	50	A
				$T_c=80^{\circ}\text{C}$	35	
		$I_{CP}$	1ms	$T_c=25^{\circ}\text{C}$	100	
				$T_c=80^{\circ}\text{C}$	70	
$-I_c$	Duty=70%		50			
$-I_c$ pulse	1ms	100				
Collector power dissipation	$P_c$	1 device	205	W		
Brake	Collector-Emitter voltage	$V_{CES}$	1200	V		
	Gate-Emitter voltage	$V_{GES}$	$\pm 20$	V		
	Collector current	$I_c$	Continuous	$T_c=25^{\circ}\text{C}$	25	A
				$T_c=80^{\circ}\text{C}$	15	
		$I_{CP}$	1ms	$T_c=25^{\circ}\text{C}$	50	
				$T_c=80^{\circ}\text{C}$	30	
Collector power dissipation	$P_c$	1 device	115	W		
Repetitive peak reverse voltage	$V_{RRM}$		1200	V		
Converter	Repetitive peak reverse voltage	$V_{RRM}$	1600	V		
	Average output current	$I_o$	50Hz/60Hz sine wave	50	A	
	Surge current (Non-Repetitive)	$I_{FSM}$	$T_j=150^{\circ}\text{C}$ , 10ms	260	A	
	$I^2t$ (Non-Repetitive)	$I^2t$	half sine wave	338	$\text{A}^2\text{s}$	
Operating junction temperature	$T_j$		+150	$^{\circ}\text{C}$		
Storage temperature	$T_{stg}$		-40 to +125	$^{\circ}\text{C}$		
Isolation voltage	between terminal and copper base *2 between thermistor and others *3	$V_{iso}$	AC : 1 minute	AC 2500	V	
				AC 2500		
Mounting screw torque			3.5 *1	N·m		

\*1 Recommendable value : 2.5 to 3.5 N·m (M5)

\*2 All terminals should be connected together when isolation test will be done.

\*3 Two thermistor terminals should be connected together, each other terminals should be connected together and shorted to base plate when isolation test will be done.

## ● Electrical characteristics (T<sub>j</sub>=25°C unless otherwise specified)

Item	Symbol	Condition	Characteristics			Unit			
			Min.	Typ.	Max.				
Inverter	Zero gate voltage collector current	ICES	V <sub>CE</sub> =1200V, V <sub>GE</sub> =0V			1.0	mA		
	Gate-Emitter leakage current	IGES	V <sub>CE</sub> =0V, V <sub>GE</sub> =±20V			200	nA		
	Gate-Emitter threshold voltage	V <sub>GE(th)</sub>	V <sub>CE</sub> =20V, I <sub>C</sub> =50mA			4.5	6.5	8.5	V
	Collector-Emitter saturation voltage	V <sub>CE(sat)</sub> (terminal)	V <sub>GE</sub> =15V I <sub>C</sub> =50A	T <sub>J</sub> =25°C		2.40	2.80	V	
				T <sub>J</sub> =125°C		2.75			
		V <sub>CE(sat)</sub> (chip)		T <sub>J</sub> =25°C		2.00	2.40		
				T <sub>J</sub> =125°C		2.35			
	Input capacitance	C <sub>ies</sub>	V <sub>GE</sub> =0V, V <sub>CE</sub> =10V, f=1MHz			4		nF	
	Turn-on time	t <sub>on</sub>	V <sub>CC</sub> =600V			0.53	1.20	μs	
		t <sub>r</sub>	I <sub>C</sub> =50A			0.43	0.60		
		t <sub>r(i)</sub>	V <sub>GE</sub> =±15V			0.03			
	Turn-off time	t <sub>off</sub>	R <sub>G</sub> = 33 Ω			0.37	1.00	μs	
		t <sub>f</sub>				0.07	0.30		
Forward on voltage	V <sub>F</sub> (terminal)	V <sub>GE</sub> = 0 V I <sub>F</sub> =50A	T <sub>J</sub> =25°C		2.40	2.80	V		
			T <sub>J</sub> =125°C		2.65				
	V <sub>F</sub> (chip)		T <sub>J</sub> =25°C		2.00	2.40			
			T <sub>J</sub> =125°C		2.25				
Reverse recovery time	t <sub>rr</sub>	I <sub>F</sub> =50A				0.35	μs		
Brake	Zero gate voltage collector current	ICES	V <sub>CE</sub> =1200V, V <sub>GE</sub> =0V			1.0	mA		
	Gate-Emitter leakage current	IGES	V <sub>CE</sub> =0V, V <sub>GE</sub> =±20V			200	nA		
	Collector-Emitter saturation voltage	V <sub>CE(sat)</sub> (terminal)	I <sub>C</sub> =25A V <sub>GE</sub> =15V	T <sub>J</sub> =25°C		2.30	2.80	V	
				T <sub>J</sub> =125°C		2.75			
		V <sub>CE(sat)</sub> (chip)		T <sub>J</sub> =25°C		2.10	2.60		
				T <sub>J</sub> =125°C		2.55			
	Turn-on time	t <sub>on</sub>	V <sub>CC</sub> =600V			0.53	1.20	μs	
		t <sub>r</sub>	I <sub>C</sub> =25A			0.43	0.60		
	Turn-off time	t <sub>off</sub>	V <sub>GE</sub> =±15V			0.37	1.00	μs	
		t <sub>f</sub>	R <sub>G</sub> = 68 Ω			0.07	0.30		
	Reverse current	I <sub>RRM</sub>	V <sub>R</sub> =1200V				1.0	mA	
	Converter	Forward on voltage	V <sub>FM</sub>	I <sub>F</sub> =50 A	terminal	1.55	1.90	V	
				V <sub>GE</sub> =0V	chip	1.40			
Reverse current	I <sub>RRM</sub>	V <sub>R</sub> =1600V				1.0	mA		
Thermistor	Resistance	R	T=25°C			5000	Ω		
			T=100°C			465		495	520
B value	B	T=25/50°C			3305	3375	3450	K	

## ● Thermal resistance Characteristics

Item	Symbol	Condition	Characteristics			Unit
			Min.	Typ.	Max.	
Thermal resistance ( 1 device )	R <sub>th(j-c)</sub>	Inverter IGBT			0.60	°C/W
		Inverter FWD			0.95	
		Brake IGBT			1.07	
		Converter Diode			0.90	
Contact thermal resistance *	R <sub>th(c-f)</sub>	With thermal compound		0.05		

\* This is the value which is defined mounting on the additional cooling fin with thermal compound

## ■ Equivalent Circuit Schematic

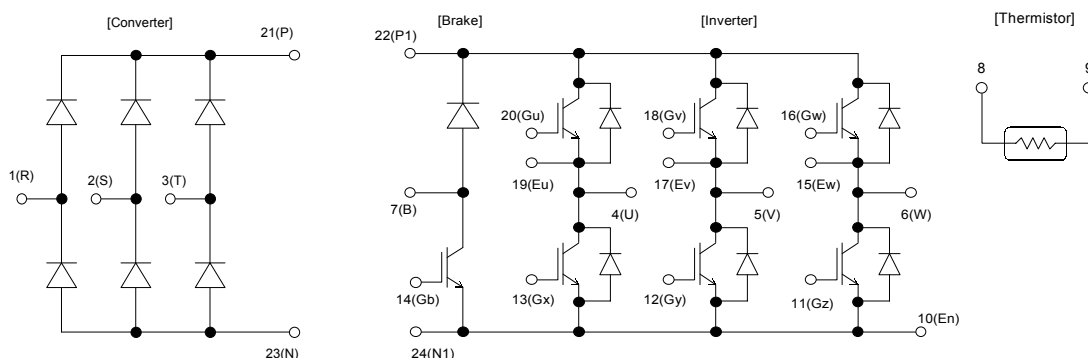

■ Characteristics (Representative)

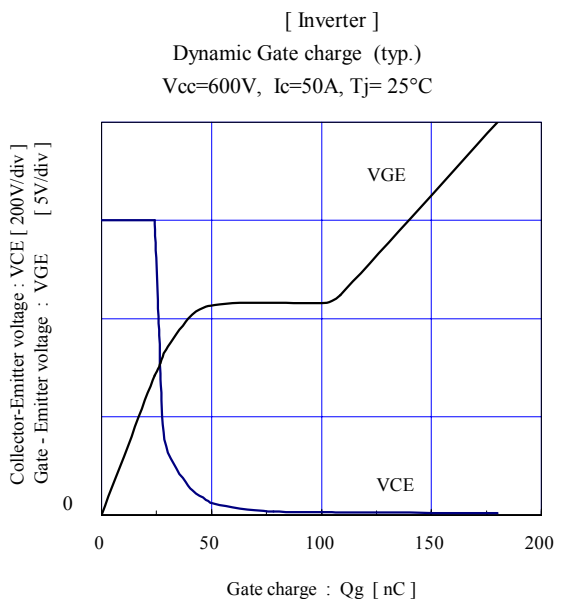
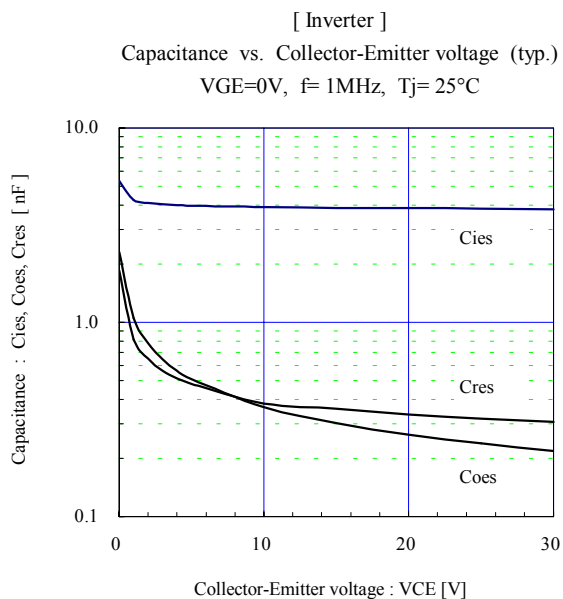
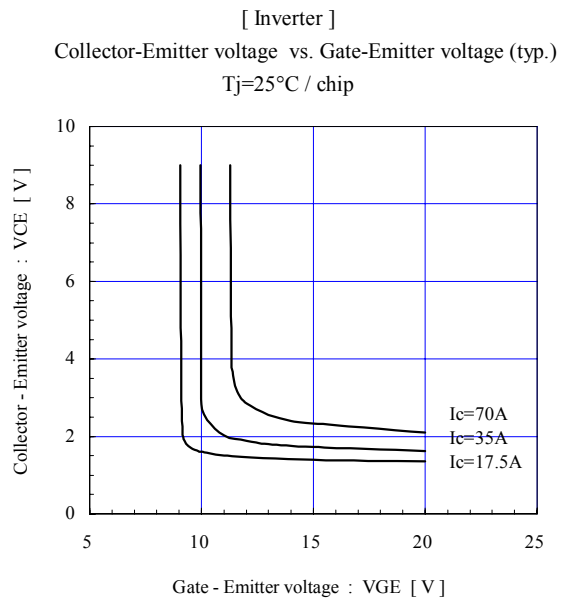
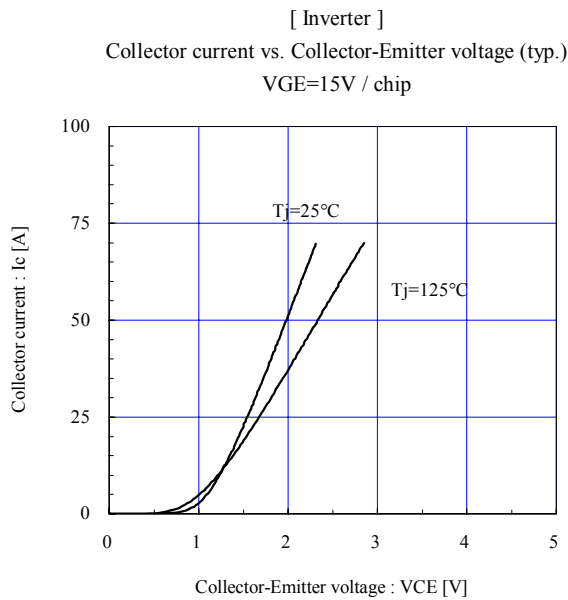
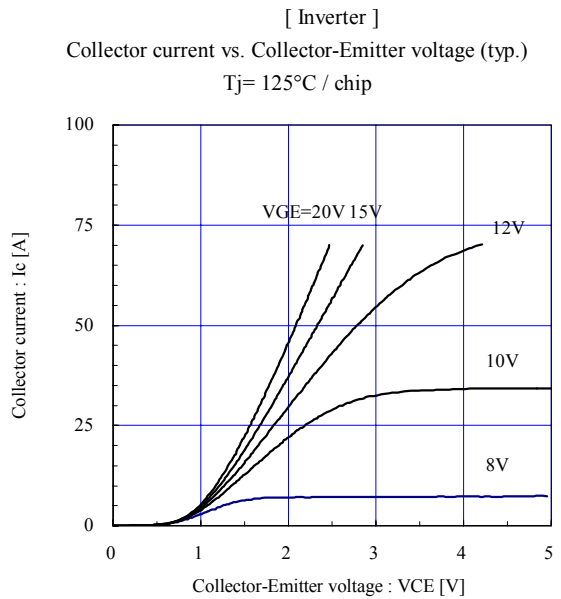
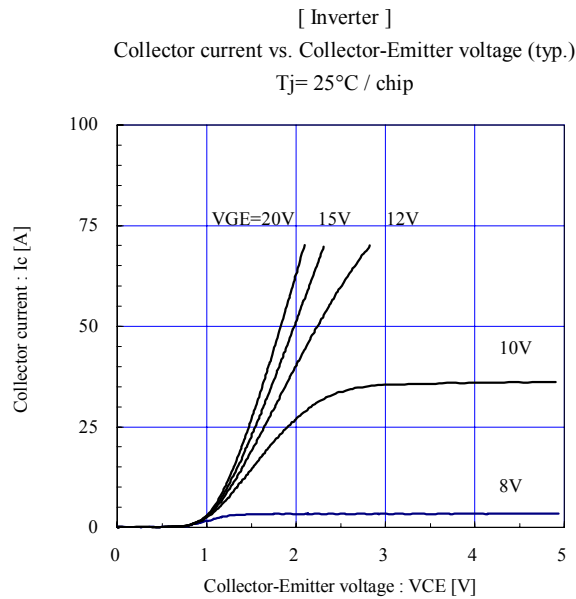

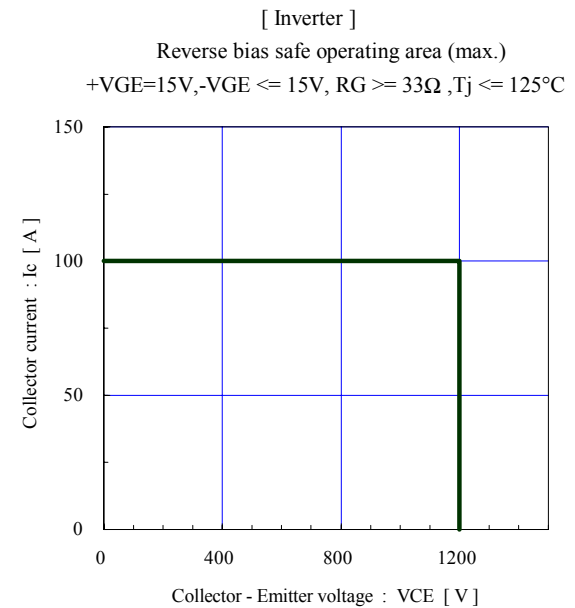
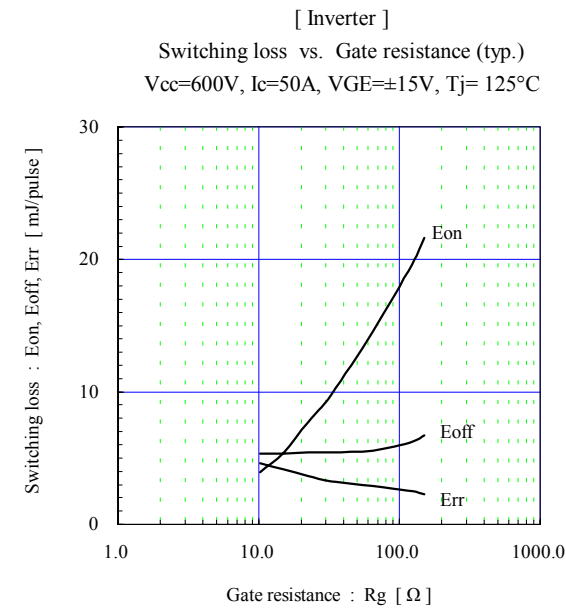
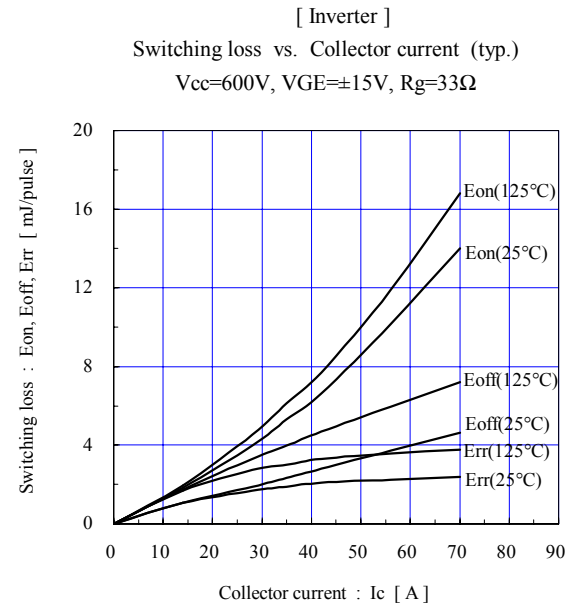
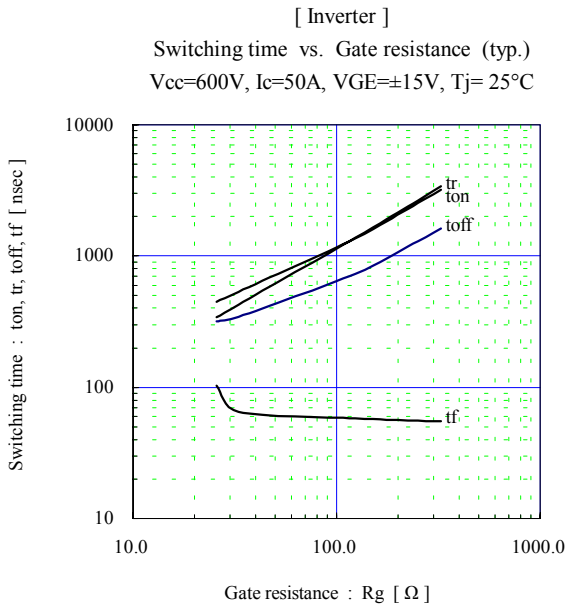
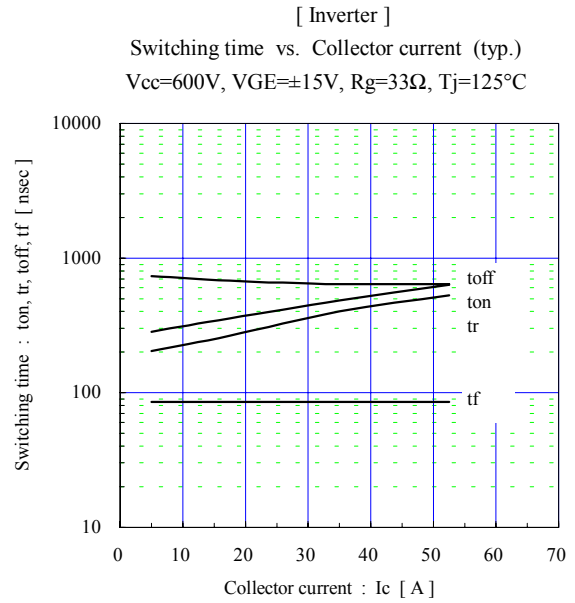
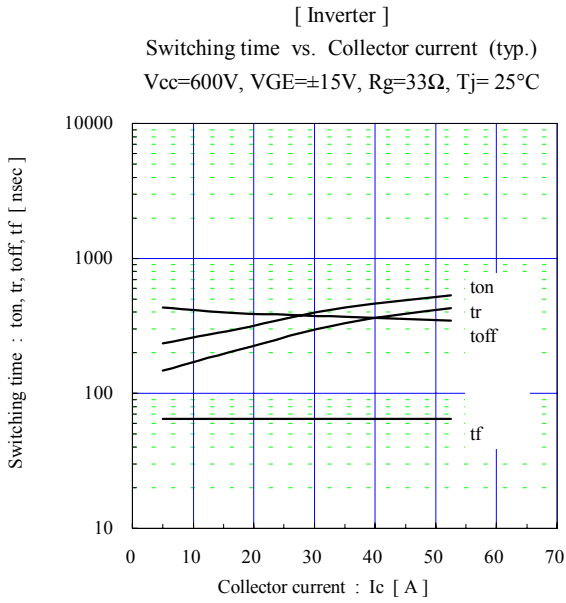

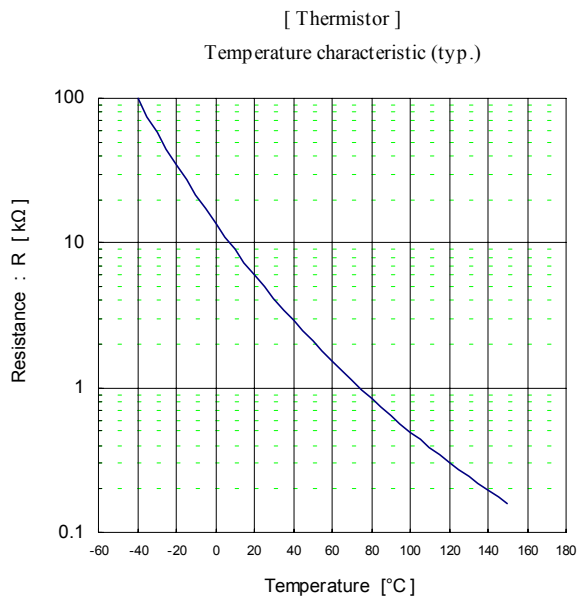
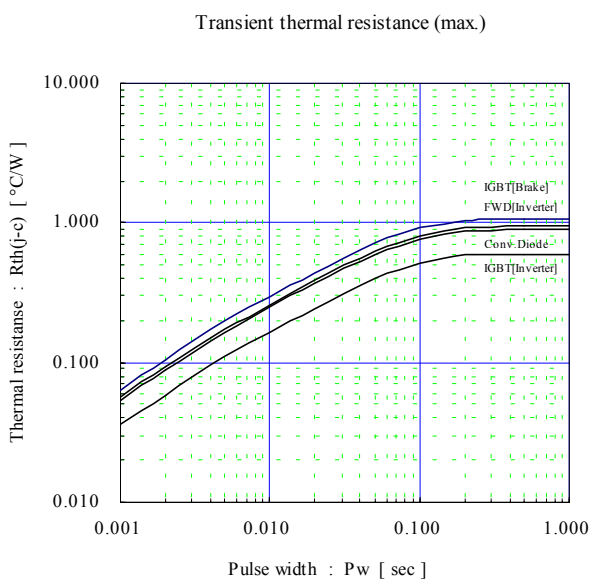
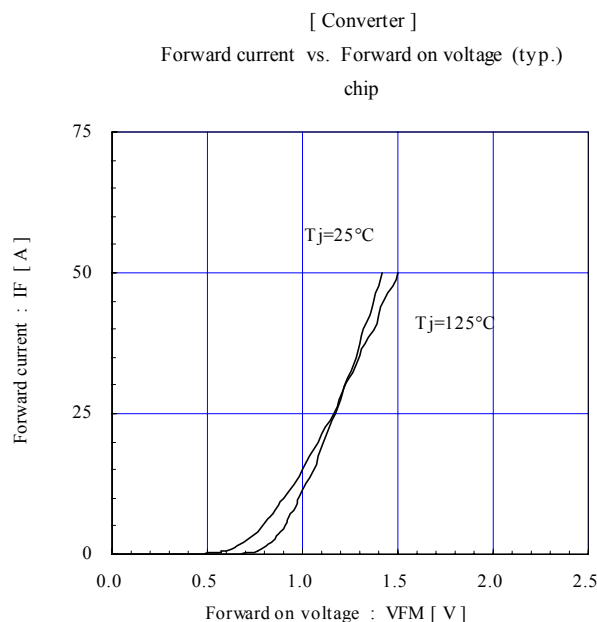
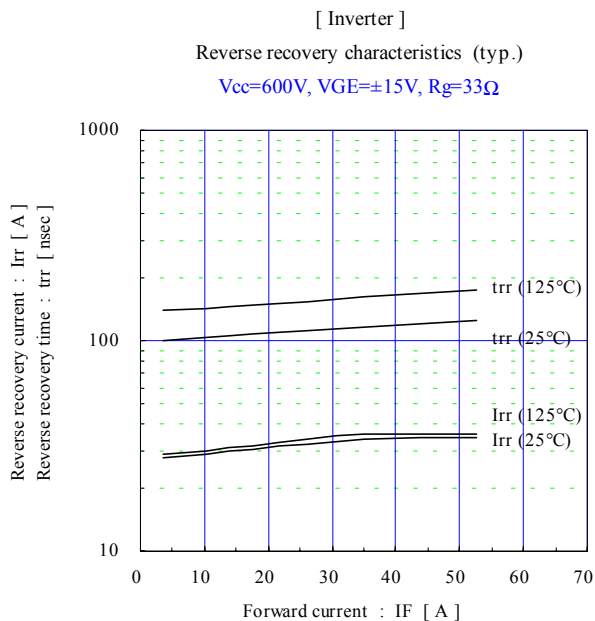
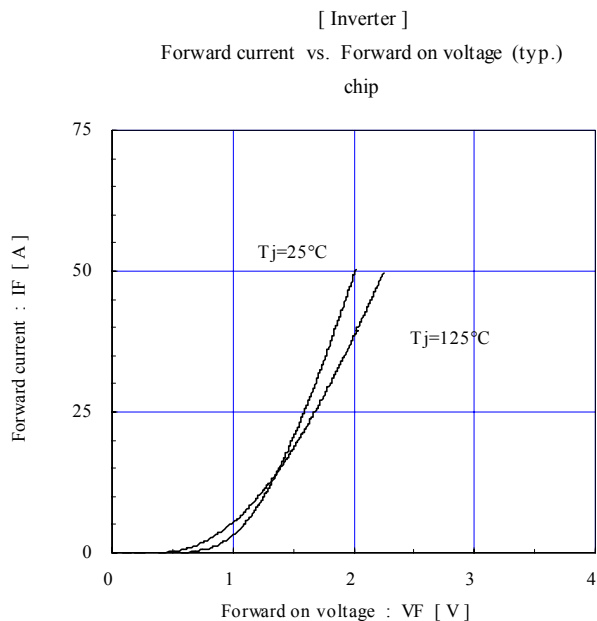

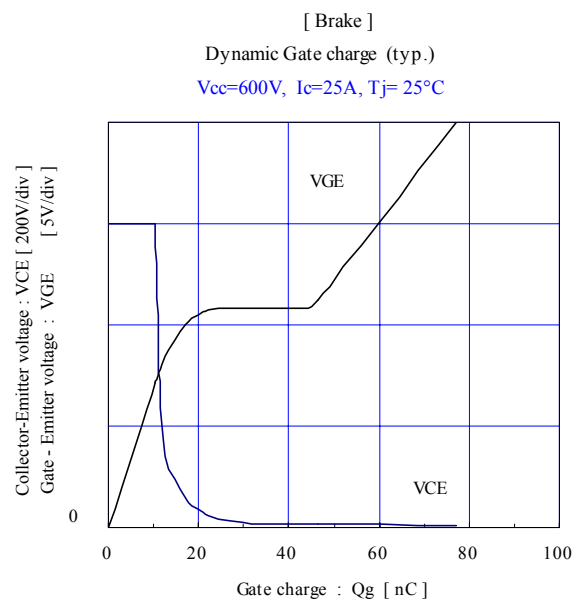
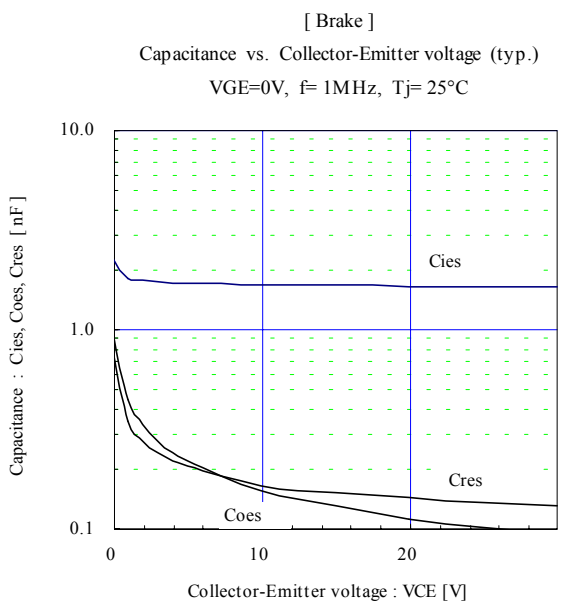
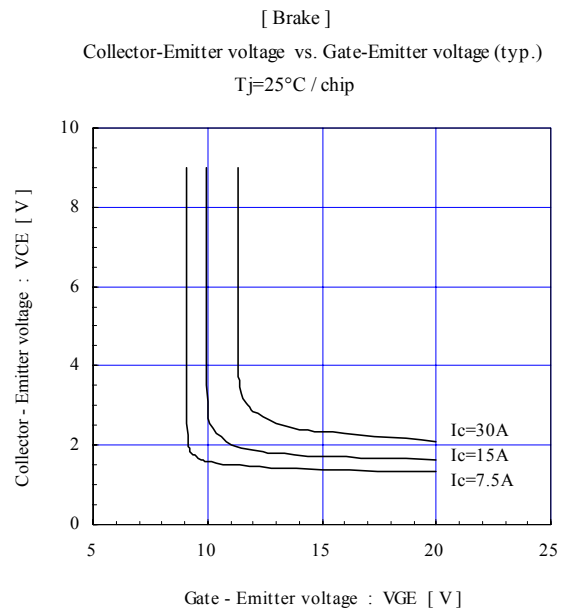
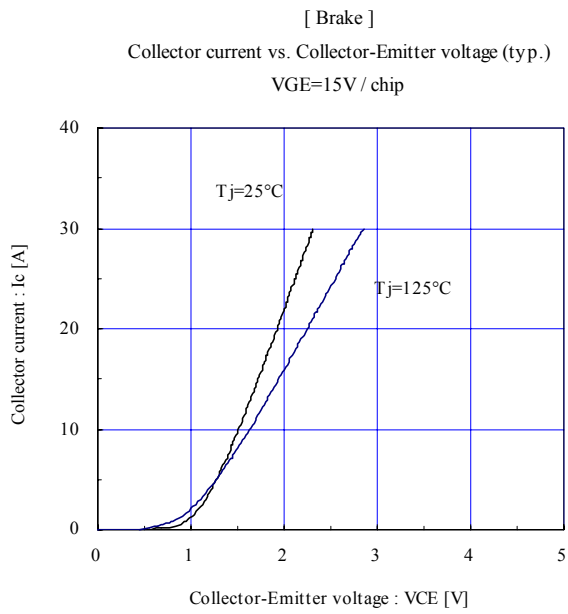
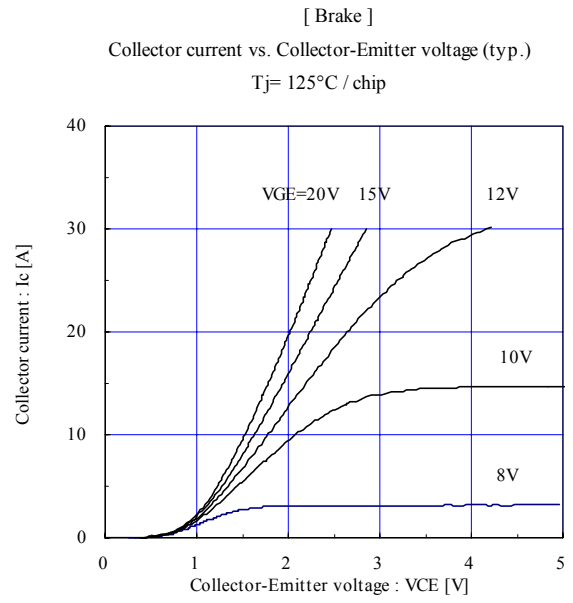
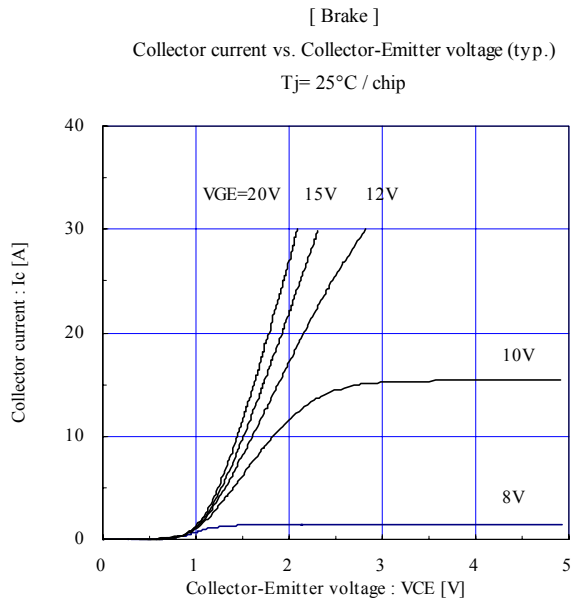

■ Outline Drawings, mm

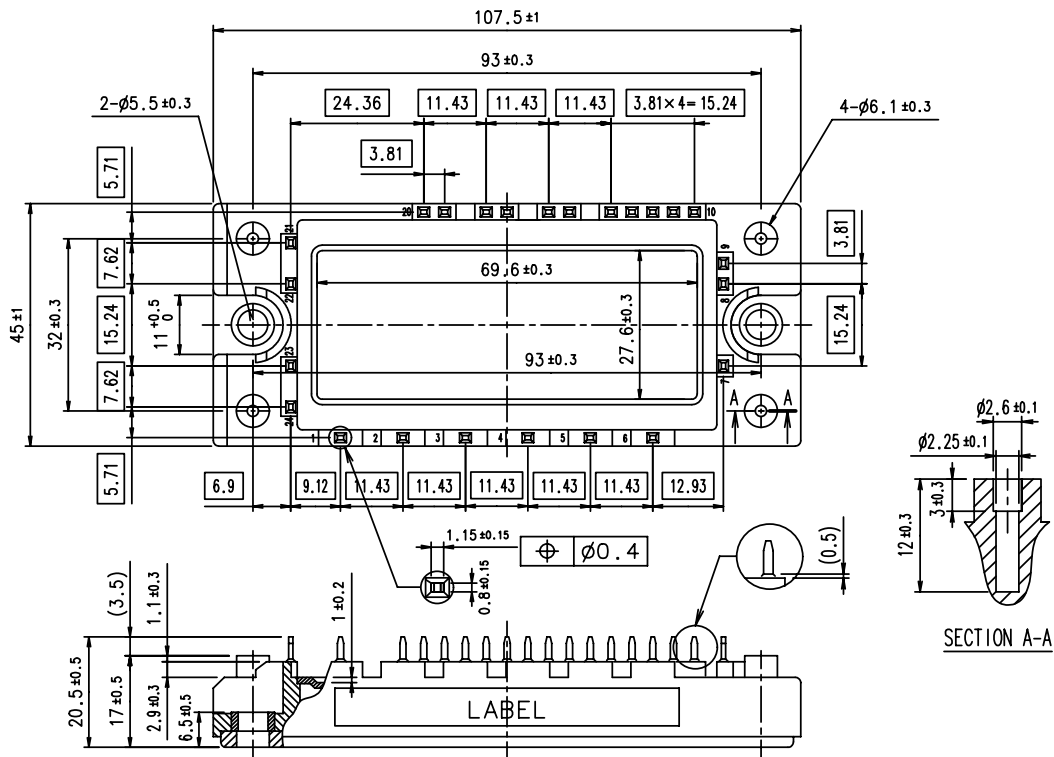

□ shows theoretical dimension.  
 ( ) shows reference dimension.