

# TP802C06 (10A)

(60V / 10A)

## SCHOTTKY BARRIER DIODE

### Outline drawings, mm

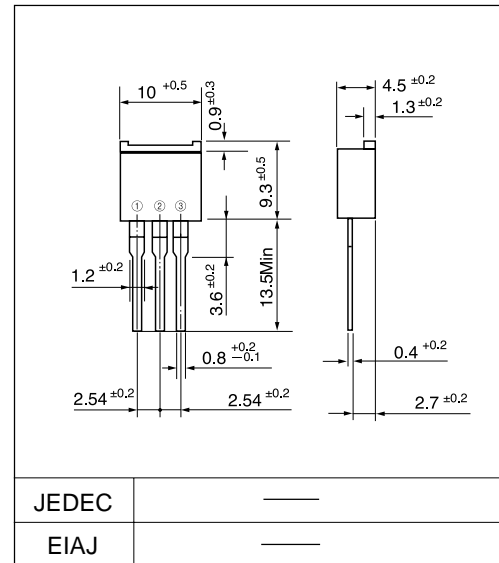

### Features

- Low  $V_F$
- Super high speed switching
- High reliability by planer design

### Applications

- High speed power switching

### Connection diagram

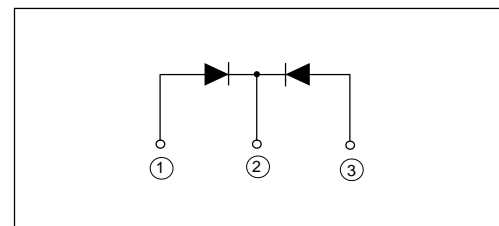

### Maximum ratings and characteristics

- Absolute maximum ratings

Item	Symbol	Conditions	Rating	Unit
Repetitive peak reverse voltage	$V_{RRM}$		60	V
Non-repetitive peak reverse voltage	$V_{RSM}$	$t_w=500\text{ns}$ , $\text{duty}=1/40$	60	V
Average output current	$I_o$	Square wave, $\text{duty}=1/2$ $T_c=123^\circ\text{C}$	10*	A
Surge current	$I_{FSM}$	Sine wave 10ms	80	A
Operating junction temperature	$T_j$		-40 to +150	$^\circ\text{C}$
Storage temperature	$T_{stg}$		-40 to +150	$^\circ\text{C}$

\* Average forward current of centertap full wave connection

- Electrical characteristics ( $T_a=25^\circ\text{C}$  Unless otherwise specified)

Item	Symbol	Conditions	Max.	Unit
Forward voltage drop	$V_{FM}$	$I_{FM}=4.0\text{A}$	0.58	V
Reverse current	$I_{RRM}$	$V_R=V_{RRM}$	5.0	mA
Thermal resistance	$R_{th(j-c)}$	Junction to case	3.0	$^\circ\text{C}/\text{W}$

Characteristics

Forward Characteristic (typ.)

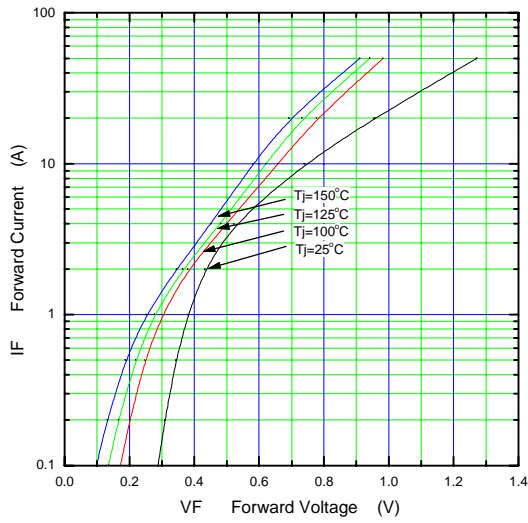

Reverse Characteristic (typ.)

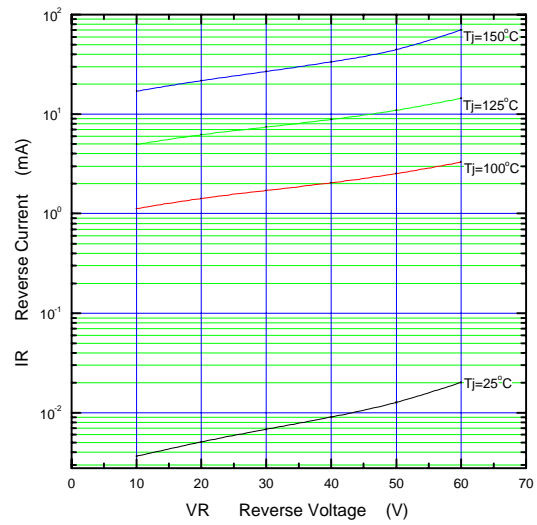

Forward Power Dissipation

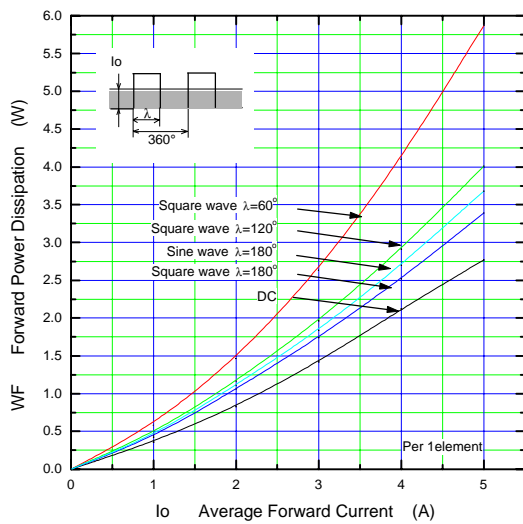

Reverse Power Dissipation

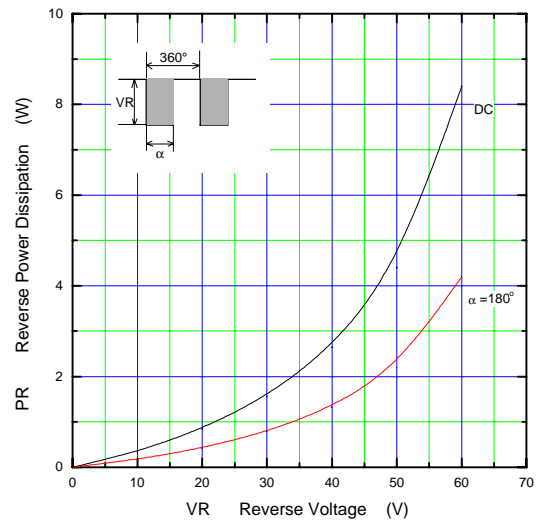

Current Derating (I<sub>o</sub>-T<sub>c</sub>)

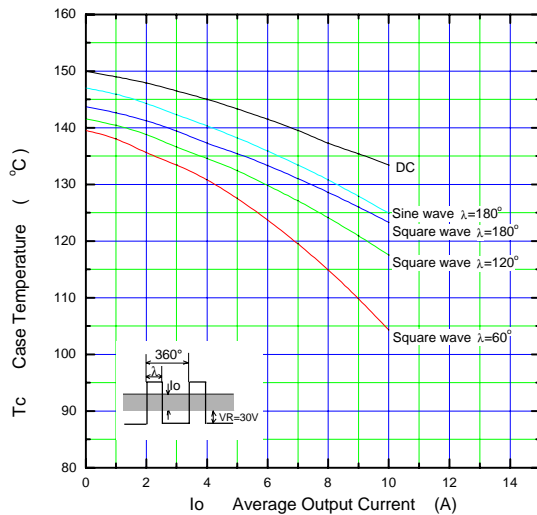

Junction Capacitance Characteristic (typ.)

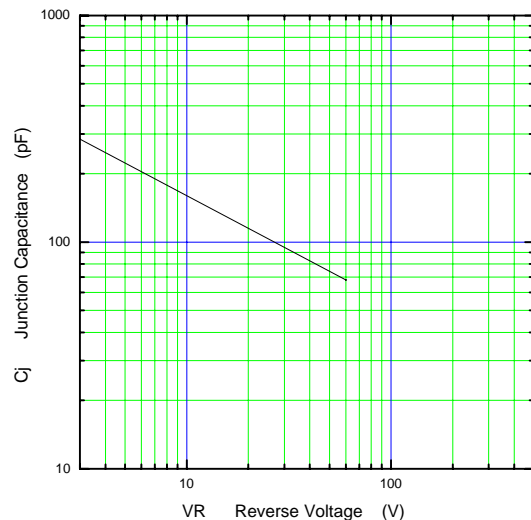

λ :Conduction angle of forward current for each rectifier element  
I<sub>o</sub>:Output current of center-tap full wave connection

Surge Capability

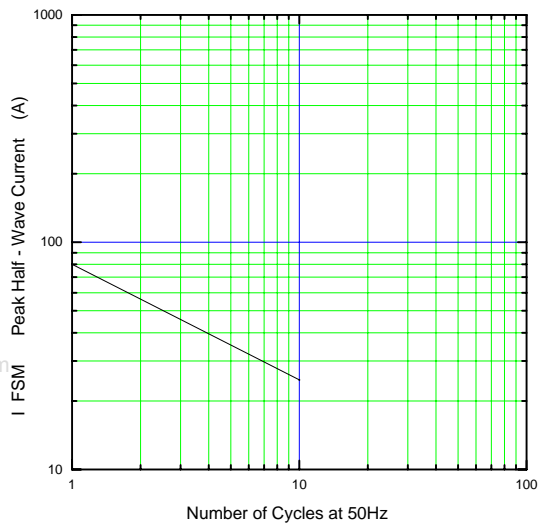

Transient Thermal Impedance

