

# MCS<sup>®</sup>-96 809X-90, 839X-90

- 839X: an 809X with 8 Kbytes of On-Chip ROM
- High Speed Pulse I/O
- 10-Bit A/D Converter
- 6.25  $\mu$ s 16 x 16 Multiply
- 6.25  $\mu$ s 32/16 Divide
- 8 Interrupt Sources
- Pulse-Width Modulated Output
- 232 Byte Register File
- Memory-to-Memory Architecture
- Full Duplex Serial Port
- Five 8-Bit I/O Ports
- Watchdog Timer
- Four 16-Bit Software Timers

The MCS<sup>®</sup>-96 family of 16-bit microcontrollers consists of many members, all of which are designed for high-speed control functions. Members with the "-90" suffix are described in this data sheet.

www.DataSheet4U.com

The CPU supports bit, byte, and word operations. 32-bit double-words are supported for a subset of the instruction set. With a 12 MHz input frequency the 8096 can do a 16-bit addition in 1.0  $\mu$ s and a 16 x 16-bit multiply or 32/16-bit divide in 6.25  $\mu$ s. Instruction execution times average 1 to 2  $\mu$ s in typical applications.

Four high-speed trigger inputs are provided to record the times at which external events occur. Six high-speed pulse generator outputs are provided to trigger external events at present times. The high-speed output unit can simultaneously perform timer functions. Up to four such 16-bit Software Timers can be in operation at once.

An on-chip A/D Converter converts up to 4 (in the 48-pin version) or 8 (in the 68-pin version) analog input channels to 10-bit digital values. This feature is only available on the 8095-90/8395-90 and 8097-90/8397-90.

Also provided on-chip are a serial port, a watchdog timer, and a pulse-width modulated output signal.

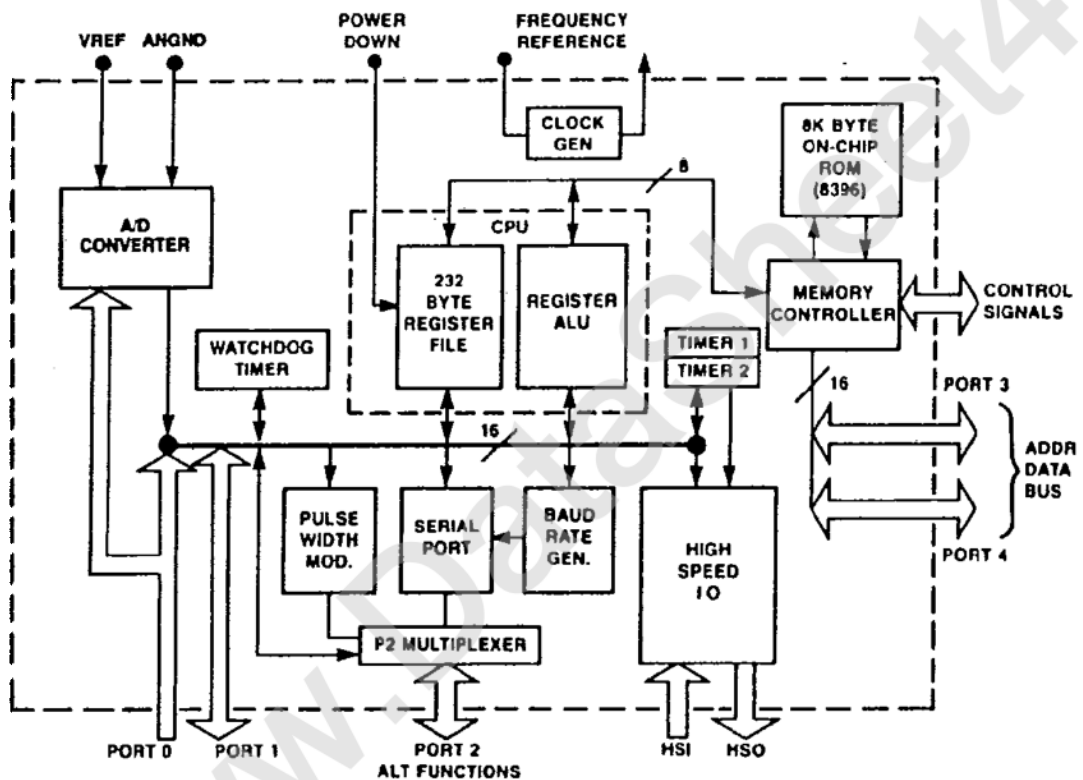

270014-1

Figure 1. Block Diagram

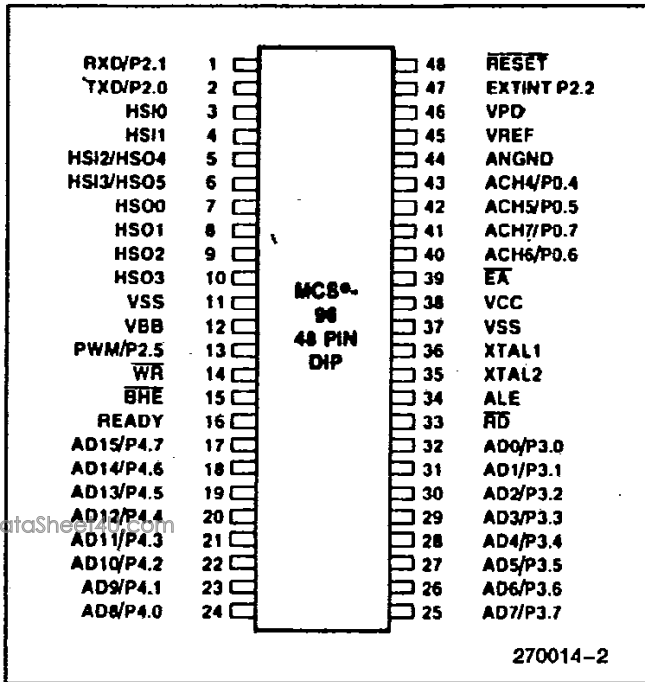

Figure 2. 48-Pin Package

Figure 1 shows a block diagram of the MCS-96 parts, generally referred to as the 8096. The 8096 is available in 48-pin and 68-pin packages, with and without A/D, and with and without on-chip ROM. The MCS-96 numbering system is shown below:

Options		68-Pin	48-Pin
Digital I/O	ROMLESS	8096-90	
	ROM	8396-90	
Analog and Digital I/O	ROMLESS	8097-90	8095-90
	ROM	8397-90	8395-90

T-49-19-59

Figures 2, 3 and 4 show the pinouts for the 48- and 68-pin packages. The 48-pin version is offered in a Dual-In-Line package while the 68-pin version comes in a Plastic Leaded Chip Carrier and a Pin Grid Array.

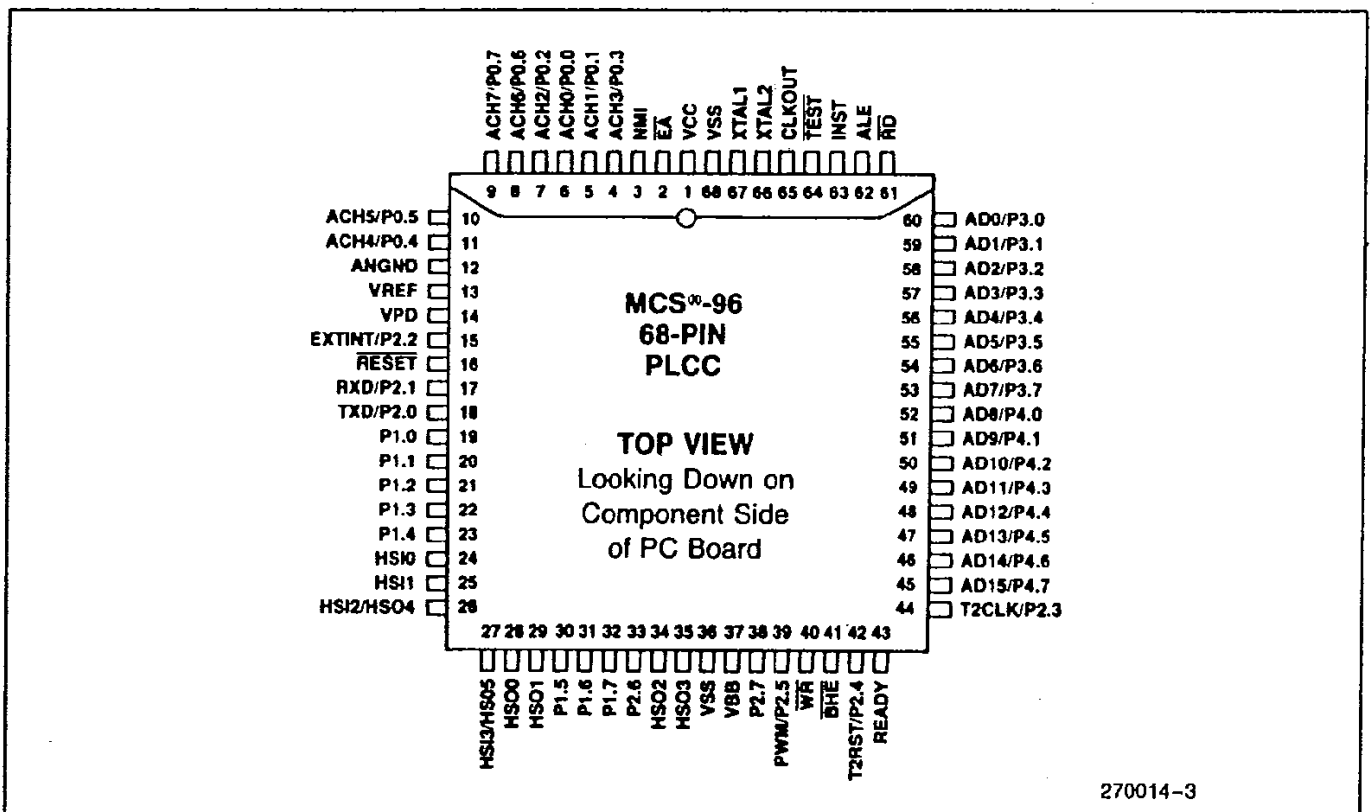

Figure 3. 68-Pin PLCC Package

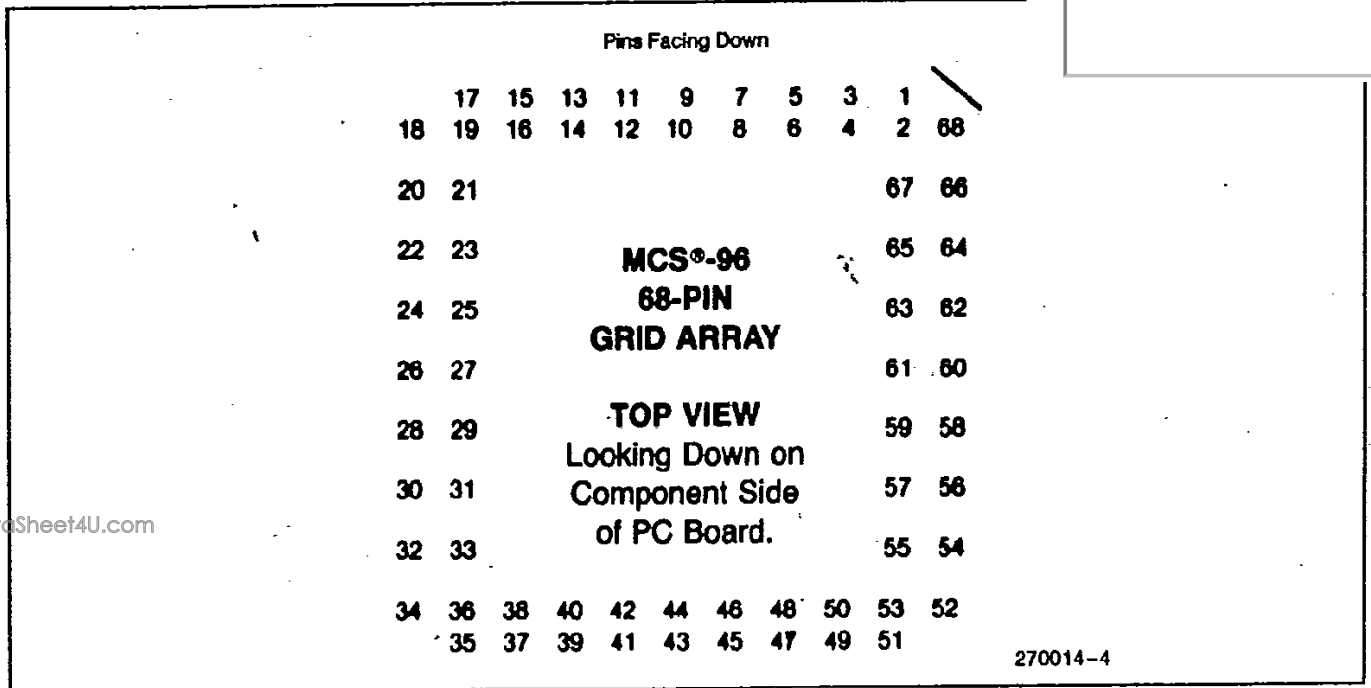

Figure 4. Pin Grid Array

PGA	PLCC	Description	PGA	PLCC	Description	PGA	PLCC	Description
1	9	ACH7/P0.7	24	54	AD6/P3.6	47	31	P1.6
2	8	ACH6/P0.6	25	53	AD7/P3.7	48	30	P1.5
3	7	ACH2/P0.2	26	52	AD8/P4.0	49	29	HSO.1
4	6	ACH0/P0.0	27	51	AD9/P4.1	50	28	HSO.0
5	5	ACH1/P0.1	28	50	AD10/P4.2	51	27	HSO.5/HSI.3
6	4	ACH3/P0.3	29	49	AD11/P4.3	52	26	HSO.4/HSI.2
7	3	NMI	30	48	AD12/P4.4	53	25	HSI.1
8	2	EA	31	47	AD13/P4.5	54	24	HSI.0
9	1	VCC	32	46	AD14/P4.6	55	23	P1.4
10	68	VSS	33	45	AD15/P4.7	56	22	P1.3
11	67	XTAL1	34	44	T2CLK/P2.3	57	21	P1.2
12	66	XTAL2	35	43	READY	58	20	P1.1
13	65	CLKOUT	36	42	T2RST/P2.4	59	19	P1.0
14	64	TEST	37	41	BHE	60	18	TXD/P2.0
15	63	INST	38	40	WR	61	17	RXD/P2.1
16	62	ALE	39	39	PWM/P2.5	62	16	RESET
17	61	RD	40	38	P2.7	63	15	EXTINT/P2.2
18	60	AD0/P3.0	41	37	VBB	64	14	VPD
19	59	AD1/P3.1	42	36	VSS	65	13	VREF
20	58	AD2/P3.2	43	35	HSO.3	66	12	ANGND
21	57	AD3/P3.3	44	34	HSO.2	67	11	ACH4/P0.4
22	56	AD4/P3.4	45	33	P2.6	68	10	ACH5/P0.5
23	55	AD5/P3.5	46	32	P1.7			

www.DataSheet4U.com

270014-4

### FUNCTIONAL OVERVIEW

The following section is an overview of the 8096, the generic part number used to refer to the entire MCS-96 product family. Additional information is available in the Microcontroller Handbook, order number 210918-004.

### CPU Architecture

The 8096 has 64 Kbyte addressability and uses the same address space for both program and data memory, except in the address range from 00H through 0FFH. Data fetches in this range are always to the Register File, while instruction fetches from these locations are directed to external memory. (Locations 00H through 0FFH in external memory are reserved for Intel development systems.)

Within the Register File, locations 00H through 17H are register mapped I/O control registers, also re-

ferred to as Special Function Registers (SFRs). The rest of the Register File (018H through 0FFH) contains 232 bytes of RAM, which can be referenced as bytes, words, or double-words. This register space allows the user to keep the most frequently-used variables in on-chip RAM, which can be accessed faster than external memory. Locations 0F0H through 0FFH can be preserved during power down if power is applied to the VPD pin.

Outside of the register file, program memory, data memory, and peripherals can be intermixed. The addresses with special significance are:

- 0000H—0017H Register-mapped I/O (SFRs)
- 0018H—0019H Stack Pointer
- 1FFEH—1FFFH Ports 3 and 4
- 2000H—2011H Interrupt Vectors
- 2012H—207FH Factory Test Code
- 2080H Reset Location

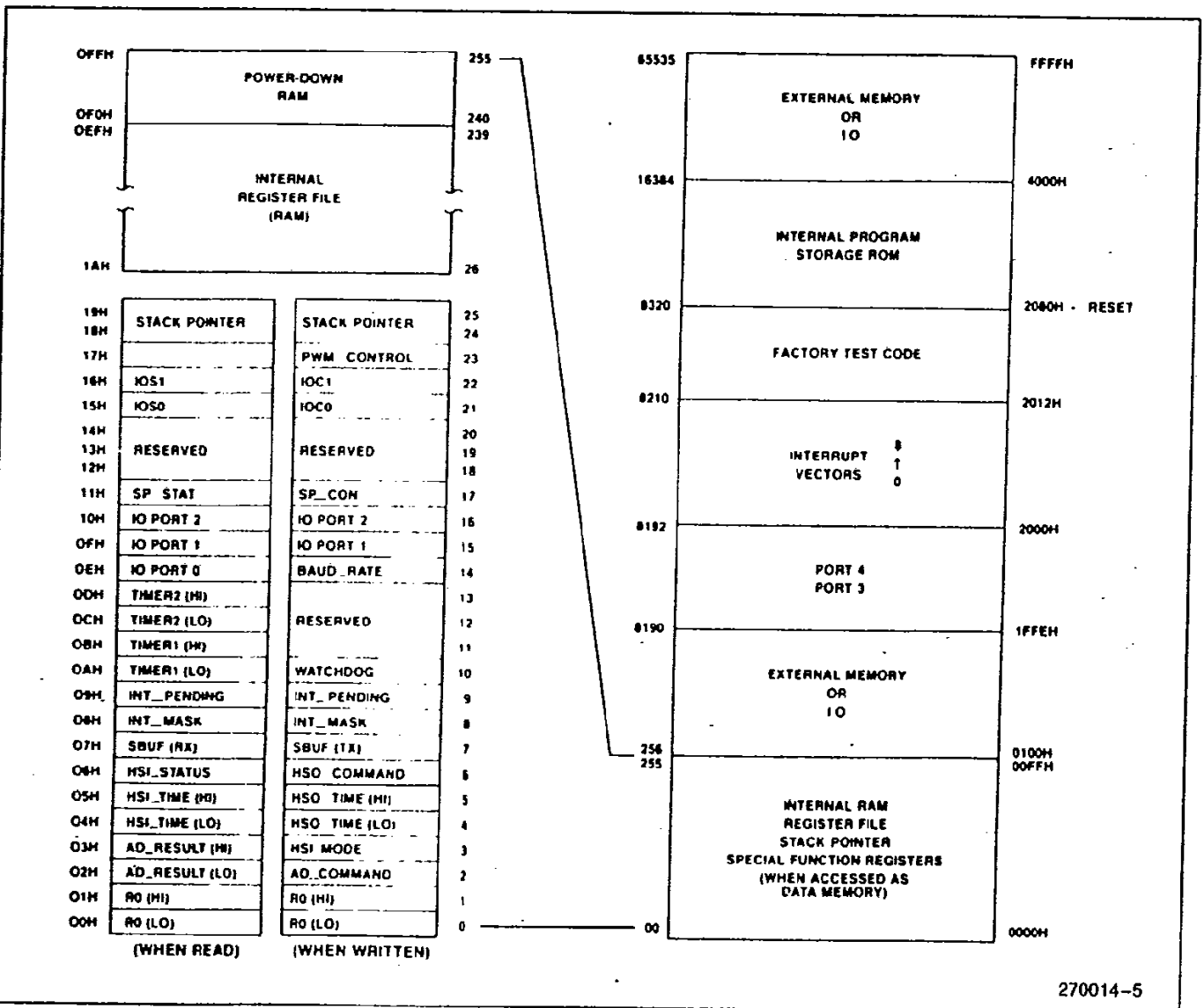

Figure 5. Memory Map

The 839x carries 8 Kbytes of on-chip ROM, occupying addresses 2000H through 3FFFH. Instruction or data fetches from these addresses access the on-chip ROM if the  $\overline{EA}$  pin is externally held at a logical 1. If the  $\overline{EA}$  pin is at a logical 0 these addresses access off-chip memory.

A memory map for the MCS-96 product family is shown in Figure 5.

The RALU (Register/ALU) section consists of a 17-bit ALU, the Program Status Word, the Program Counter, and several temporary registers. A key feature of the 8096 is that it does not use an accumulator. Rather, it operates directly on any register in the Register File. Being able to operate directly on data in the Register File without having to move it into and out of an accumulator results in a significant improvement in execution speed.

In addition to the normal arithmetic and logical functions, the MCS-96 instruction set provides the following special features:

6.25  $\mu$ s Multiply and Divide  
Multiple Shift Instructions

3 Operand Instructions  
Normalize Instruction  
Software Reset Instruction

All operations on the 8096 take place in a set number of "State Times." The 8096 uses a three-phase

internal clock, so each state time is 3 oscillator periods. With a 12 MHz clock, each state time requires 0.25 microseconds.

### High Speed I/O Unit (HSIO)

The HSIO unit consists of the High Speed Input Unit (HSI), the High Speed Output Unit (HSO), one counter and one timer. "High Speed" denotes that the units can perform functions related to the timers without CPU intervention. The HSI records times when events occur and the HSO triggers events at preprogrammed times.

All actions within the HSIO unit are synchronized to the timers. The two 16-bit timer/counter registers in the HSIO unit are cleared on chip reset and can be programmed to generate an interrupt on overflow. The Timer 1 register is automatically incremented every 8 state times (every 2.0 microseconds, with a 12 MHz clock). The Timer 2 register can be programmed to count transitions on either the T2CLK pin or HSI.1 pin. It is incremented on both positive and negative edges of the selected input line. In addition to being cleared by reset, Timer 2 can also be cleared in software or by signals from input pins T2RST or HSI.0. Neither of these timers is required for the watchdog timer or the serial port.

The High Speed Input (HSI) unit can detect transitions on any of its 4 input lines. When one occurs it records the time (from Timer 1) and which input lines

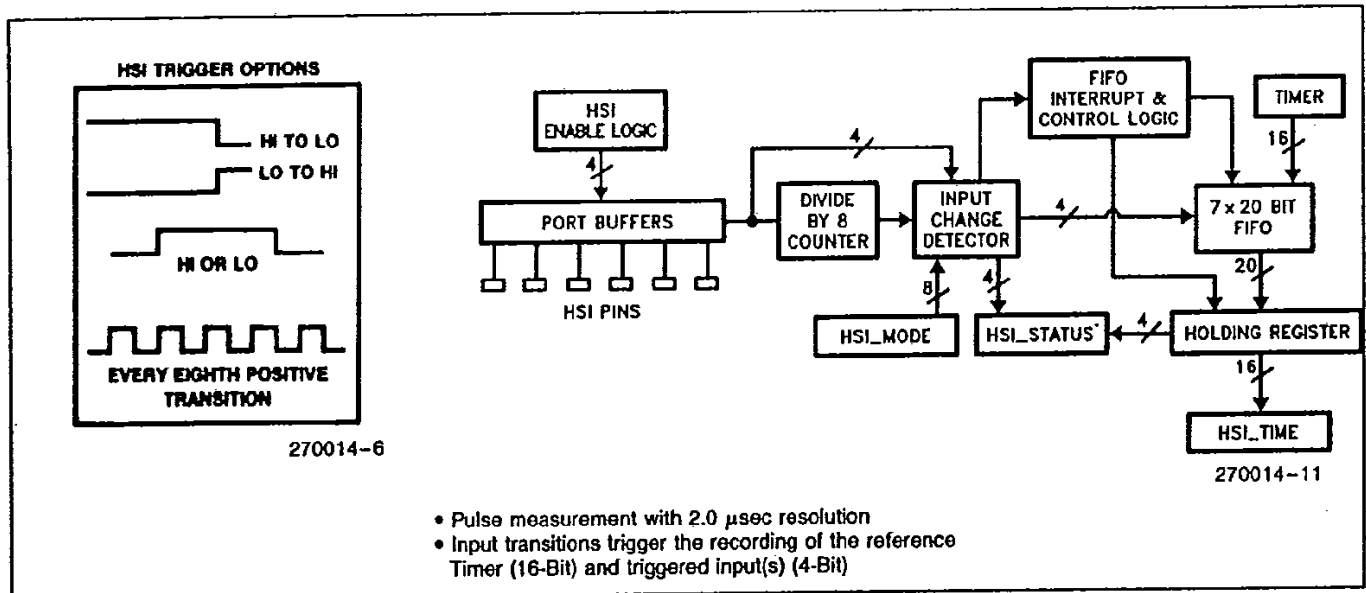

Figure 6. High Speed Input Unit

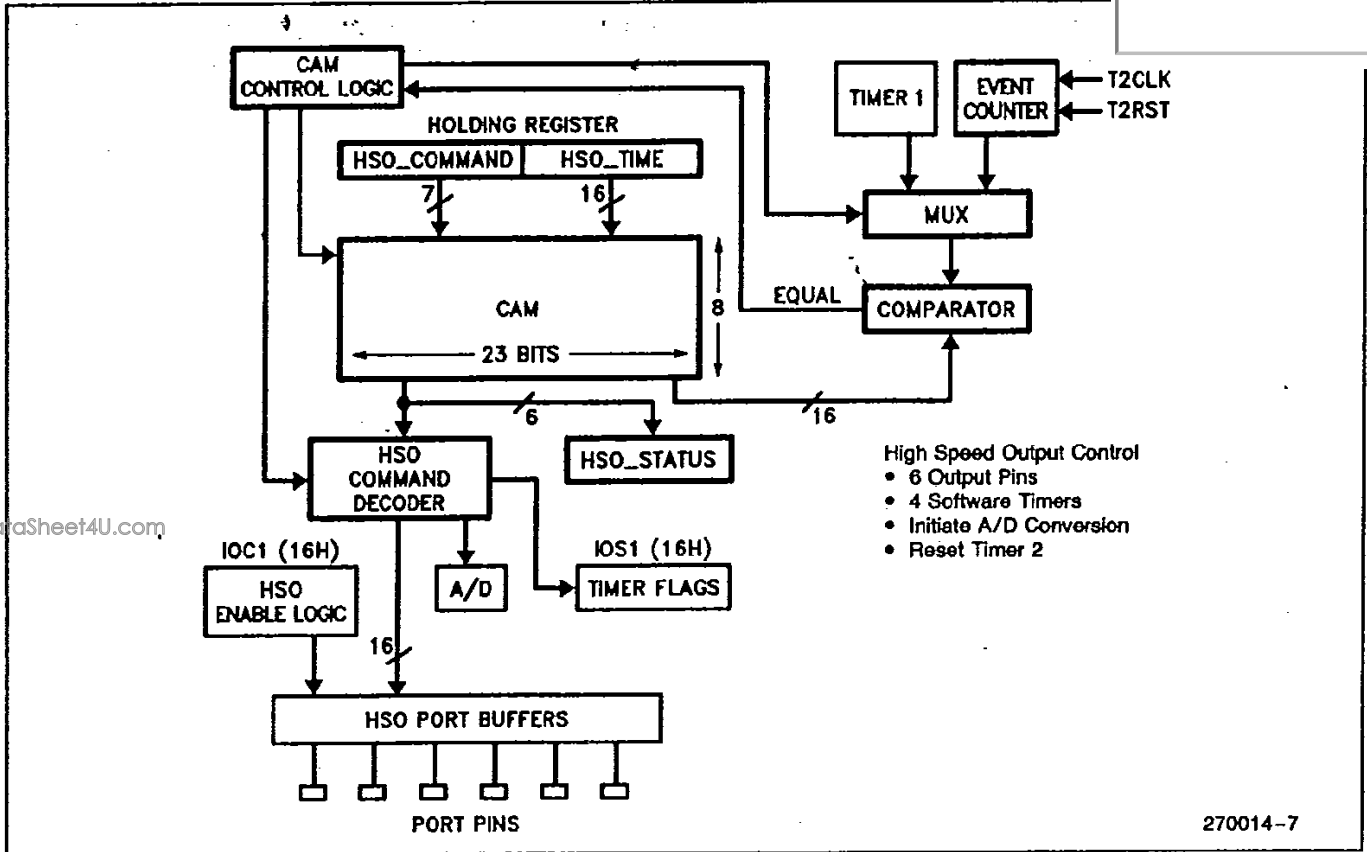

Figure 7. High Speed Output Unit

made the transition. This information is recorded with 2 microsecond resolution and stored in an 8-level FIFO. The unit can be programmed to look for four types of events, as shown in Figure 6. It can activate the HSI Data Available interrupt either when the Holding Registers is loaded or the 6th FIFO entry has been made. Each input line can be individually enabled or disabled to the HSI unit by software.

The High Speed Output (HSO) unit is shown in Figure 7. It can be programmed to set or clear any of its 6 output lines, reset Timer 2, trigger an A/D conversion, or set one of 4 Software Timers flags at a programmed time. An interrupt can be enabled for any of these events. Either Timer 1 or Timer 2 can be referenced for the programmed time value and up to 8 commands for preset actions can be stored in the CAM (Content Addressable Memory) file at any one time. As each action is carried out at its preset time that command is removed from the CAM making space for another command. HSO.4 and HSO.5 are shared with the HSI unit as HSI.2 and HSI.3, and can be individually enabled or disabled as outputs.

**Standard I/O Ports**

There are 5 8-bit I/O ports on the 8096 in addition to the High Speed I/O lines.

Port 0 is an input-only port which shares its pins with the analog inputs to the A/D Converter. The port

can be read digitally and/or, by writing to the A/D Command Register, one of the lines can be selected as the input to the A/D Converter.

Port 1 is a quasi-bidirectional I/O port. "Quasi-bidirectional" means the port pin has a weak internal pullup that is always active and an internal pulldown which can either be on (to output a 0) or off (to output a 1). This configuration allows the pin to be used as either an input or an output without using a data direction register. In parallel with the weak internal pullup, is a much stronger internal pullup that is activated for one state time when the pin is internally driven from 0 to 1. This is done to speed up the 0-to-1 transition time.

Port 2 is multi-functional port. Two of the pins are quasi-bidirectional while the remaining six are shared with other functions in the 8096, as shown below:

Port	Function	Alternate Function
P2.0	output	TXD (serial port transmit)
P2.1	input	RXD (serial port receive)
P2.2	input	EXTINT (external interrupt)
P2.3	input	T2CLK (Timer 2 clock)
P2.4	input	T2RST (Timer 2 reset)
P2.5	output	PWM (pulse-width modulation)

Ports 3 and 4 are bi-directional I/O ports with open drain outputs. These pins are also used as the multiplexed address/data bus when accessing external memory, in which case they have strong internal pullups. The internal pullups are only used during external memory read or write cycles when the pins are outputting address or data bits. At any other time, the internal pullups are disabled.

### Serial Port

The serial port is compatible with the MCS<sup>®</sup>-51 family (8051, 8031 etc.) serial port. It is full duplex, and receive-buffered. There are 3 asynchronous modes and 1 synchronous mode of operation for the serial port. The asynchronous modes allow for 8 or 9 bits of data with even parity optionally inserted for one of the data bits. Selective interrupts based on the 9th data bit are available to support interprocessor communication.

Baud rates in all modes are determined by an independent 16-bit on-chip baud rate generator. Either the XTAL 1 pin or the T2CLK pin can be used as the input to the baud rate generator. The maximum baud rate in the asynchronous mode is 187.5 Kbaud.

### Pulse Width Modulator (PWM)

The PWM output shares a pin with port bit P2.5. When the PWM output is selected, this pin outputs a pulse train having a fixed period of 256 state times, and a programmable width of 0 to 255 state times. The width is programmed by loading the desired value, in state times, to the PWM Control Register.

### A/D Converter

The analog-to-digital converter is a 10-bit, successive approximation converter. It has a fixed conversion time of 168 state times, (42 microseconds with a 12 MHz clock). The analog input must be in the range of 0 to VREF (normally, VREF = 5V). This input can be selected from 8 analog input lines, which connect to the same pins as Port 0. A conversion can be initiated either by setting a control bit in the A/D Command register, or by programming the HSO unit to trigger the conversion at some specified time.

### Interrupts

The 8096 has 20 interrupt sources which vector through 8 locations. A 0-to-1 transition from any of the sources sets a corresponding bit in the Interrupt

Pending register. The content of the Interrupt Mask register determines if a pending interrupt will be serviced or not. If it is to be serviced, the CPU pushes the current program counter onto the stack and reloads it with the vector corresponding to the desired interrupt. The interrupt vectors are located in addresses 2000H through 2011H, as shown in Figure 8.

Source	Vector Location		Priority
	(High Byte)	(Low Byte)	
Software Extint	2011H	2010H	Not Applicable
Serial Port	200FH	200EH	7 (Highest)
Software Timers	200DH	200CH	6
HSI.0	200BH	200AH	5
High Speed Outputs	2009H	2008H	4
HSI Data Available	2007H	2006H	3
A/D Conversion Complete	2005H	2004H	2
Timer Overflow	2003H	2002H	1
	2001H	2000H	0 (Lowest)

Figure 8. Interrupt Vectors

At the end of the terminal routine the RET instruction pops the program counter from the stack and execution continues where it left off. It is not necessary to store and replace registers during interrupt routines as each routine can be set up to use a different section of the register file. This feature of the architecture provides for very fast context switching.

While the 8096 has a single priority level in the sense that any interrupt may be itself be interrupted, a priority structure exists for resolving simultaneously pending interrupts, as indicated in Figure 8. Since the interrupt pending and interrupt mask registers can be manipulated in software, it is possible to dynamically alter the interrupt priorities to suit the users' software.

### Watchdog Timer

The watchdog timer is a 16-bit counter which, once started, is incremented every state time. After 16 milliseconds, if not cleared, it will overflow, pulling down the RESET pin for two state times, causing the system to be reinitialized. This feature is provided as a means of graceful recovery from a software upset. The counter must be cleared by the software before it overflows, or else the system assumes an upset has occurred and activates RESET.

**PIN DESCRIPTION****VCC**

Main supply voltage (5V).

**VSS**

Digital circuit ground (0V).

**VPD**

RAM standby supply voltage (5V). This voltage must be present during normal operation. In a Power Down condition (i.e., VCC drops to zero), if  $\overline{\text{RESET}}$  is activated before VCC drops below spec and VPD continues to be held within spec, the top 16 bytes in the Register File will retain their contents.  $\overline{\text{RESET}}$  must be held low during the Power Down and should not be brought high until VCC is within spec and the oscillator has stabilized.

**VREF**

Reference voltage for the A/D converter (5V). VREF is also the supply voltage to the analog portion of the A/D converter and the logic used to read Port 0 as digital input.

**ANGND**

Reference ground for the A/D converter. Should be held at nominally the same potential as VSS.

**VBB**

Substrate voltage from the on-chip back-bias generator. This pin should be connected to ANGND through a 0.01  $\mu\text{f}$  capacitor (and not connected to anything else).

**XTAL1**

Input of the oscillator inverter and of the internal clock generator.

**XTAL2**

Output of the oscillator inverter.

**CLKOUT**

Output of the internal clock generator. The frequency of CLKOUT is  $\frac{1}{3}$  the oscillator frequency. It has a 33% duty cycle.

 **$\overline{\text{RESET}}$** 

Reset input to the chip. Input low for at least 2 state times to reset the chip. The subsequent low-to-high transition re-synchronizes CLKOUT and commences a 10-state-time sequence in which the PSW is cleared and a jump to address 2080H is executed. Input high for normal operation.  $\overline{\text{RESET}}$  has an internal pullup.

**TEST**

Input low enables a factory test mode. The user should tie this pin to VCC for normal operation.

**NMI**

A positive transition clears the watchdog timer, and causes a vector to external memory location 0000H. External memory from 00H through 0FFH is reserved for Intel development systems.

**INST**

Output high during an external memory read indicates the read is an instruction fetch. INST needs to be latched on the falling edge of ALE.

 **$\overline{\text{EA}}$** 

Input for memory select (External Access).  $\overline{\text{EA}} = 1$  causes memory accesses to locations 2000H through 3FFFH to be directed to on-chip ROM.  $\overline{\text{EA}} = 0$  causes accesses to these locations to be directed to off-chip memory.  $\overline{\text{EA}}$  has an internal pull-down, so it goes to 0 unless driven to 1.  $\overline{\text{EA}}$  is not latched internally during RESET.

**ALE**

Address Latch Enable output. ALE is activated only during external memory accesses. It is used to latch the address from the multiplexed address/data bus, and is placed in a low condition during reset.

 **$\overline{\text{RD}}$** 

Read signal output to external memory.  $\overline{\text{RD}}$  is activated only during external memory reads.

 **$\overline{\text{WR}}$** 

Write signal output to external memory.  $\overline{\text{WR}}$  is activated only during external memory writes.



## BHE

Bus High Enable signal output to external memory.  $\overline{\text{BHE}} = 0$  selects the bank of memory that is connected to the high byte of the data bus.  $\text{A0} = 0$  selects the bank of memory that is connected to the low byte of the data bus. Thus accesses to a 16-bit wide memory can be to the low byte only ( $\text{A0} = 0$ ,  $\overline{\text{BHE}} = 1$ ), to the high byte only ( $\text{A0} = 1$ ,  $\overline{\text{BHE}} = 0$ ), or to both bytes ( $\text{A0} = 0$ ,  $\overline{\text{BHE}} = 0$ ).  $\overline{\text{BHE}}$  is activated only when required during accesses to external memory.  $\overline{\text{BHE}}$  can be ignored during read operations. This pin must be latched on the falling edge of ALE.

## READY

www.DataSheet4U.com

The READY input is used to lengthen external memory bus cycles, for interfacing to slow or dynamic memory, or for bus sharing. If the pin is high CPU operation continues in a normal manner. If the pin is low prior to the first rising edge of CLKOUT after ALE, the Memory Controller goes into a wait mode until the next negative transition in CLKOUT after ALE occurs with READY high. The bus cycle can be lengthened by up to 1  $\mu\text{s}$ . When the external memory bus is not being used, READY has no effect. READY has a weak internal pullup, so it goes to 1 unless externally pulled low.

## HSI

Inputs to High Speed Input Unit. Four HSI pins are available: HSI.0, HSI.1, HSI.2, and HSI.3. Two of them (HSI.2 and HSI.3) are shared with the HSO Unit.

## HSO

Outputs from High Speed Output Unit. Six HSO pins are available: HSO.0, HSO.1, HSO.2, HSO.3, HSO.4, and HSO.5. Two of them (HSO.4 and HSO.5) are shared with the HSI Unit.

## Port 0

8-bit high impedance input-only port. These pins can be used as digital inputs and/or as analog inputs to the on-chip A/D converter.

## Port 1

8-bit quasi-bidirectional I/O port.

## Port 2

8-bit multi-functional port. Six of its pins are shared with other functions in the 8096, the remaining 2 are quasi-bidirectional.

## Ports 3 and 4

8-bit bi-directional I/O ports with open drain outputs. These pins are shared with the multiplexed address/data bus which has strong internal pullups.

## INSTRUCTION SET

The 8096 instruction set makes use of six addressing modes as described below:

**DIRECT**—The operand is specified by an 8-bit address field in the instruction. The operand must be in the Register File or SFR space (locations 0000H through 00FFH).

**IMMEDIATE**—The operand itself follows the opcode in the instruction stream as immediate data. The immediate data can be either 8-bits or 16-bits as required by the opcode.

**INDIRECT**—An 8-bit address field in the instruction gives the address of a word register in the Register File which contains the 16-bit address of the operand. The operand can be anywhere in memory.

**INDIRECT WITH AUTO-INCREMENT**—Same as Indirect, except that, after the operand is referenced, the word register that contains the operand's address is incremented by 1 if the operand is a byte, or by 2 if the operand is a word.

**INDEXED**—The instruction contains an 8-bit address field and either an 8-bit or a 16-bit displacement field. The 8-bit address field gives the address of a word register in the Register File which contains a 16-bit base address. The 8- or 16-bit displacement field contains a signed displacement that will be added to the base address to produce the address of the operand. The operand can be anywhere in memory.

The 8096 contains a Zero Register at word address 0000H (and which contains 0000H). This register is available for performing comparisons and for use as a base register in indexed addressing. This effectively provides direct addressing to all 64K of memory.

In the 8096, the Stack Pointer is at word address 0018H in the Register File. If the 8-bit address field in an indexed instruction contains 18H, the Stack Pointer becomes the base register. This allows direct accessing of variables in the stack.

The following tables list the MCS-96 instructions, their opcodes, and execution times.

**Instruction Summary**

Mnemonic	Operands	Operation (Note 1)	Flags						Notes
			Z	N	C	V	VT	ST	
ADD/ADDB	2	$D \leftarrow D + A$	✓	✓	✓	✓	↑	—	
ADD/ADDB	3	$D \leftarrow B + A$	✓	✓	✓	✓	↑	—	
ADDC/ADDCB	2	$D \leftarrow D + A + C$	↓	✓	✓	✓	↑	—	
SUB/SUBB	2	$D \leftarrow D - A$	✓	✓	✓	✓	↑	—	
SUB/SUBB	3	$D \leftarrow B - A$	✓	✓	✓	✓	↑	—	
SUBC/SUBCB	2	$D \leftarrow D - A + C - 1$	↓	✓	✓	✓	↑	—	
CMP/CMPB	2	$D - A$	✓	✓	✓	✓	↑	—	
MUL/MULU	2	$D, D + 2 \leftarrow D \cdot A$	—	—	—	—	—	?	2
MUL/MULU	3	$D, D + 2 \leftarrow B \cdot A$	—	—	—	—	—	?	2
MULB/MULUB	2	$D, D + 1 \leftarrow D \cdot A$	—	—	—	—	—	?	3
MULB/MULUB	3	$D, D + 1 \leftarrow B \cdot A$	—	—	—	—	—	?	3
DIVU	2	$D \leftarrow (D, D + 2)/A, D + 2 \leftarrow \text{remainder}$	—	—	—	✓	↑	—	2
DIVUB	2	$D \leftarrow (D, D + 1)/A, D + 1 \leftarrow \text{remainder}$	—	—	—	✓	↑	—	3
DIV	2	$D \leftarrow (D, D + 2)/A, D + 2 \leftarrow \text{remainder}$	—	—	—	?	↑	—	2
DIVB	2	$D \leftarrow (D, D + 1)/A, D + 1 \leftarrow \text{remainder}$	—	—	—	?	↑	—	3
AND/ANDB	2	$D \leftarrow D \text{ and } A$	✓	✓	0	0	—	—	
AND/ANDB	3	$D \leftarrow B \text{ and } A$	✓	✓	0	0	—	—	
OR/ORB	2	$D \leftarrow D \text{ or } A$	✓	✓	0	0	—	—	
XOR/XORB	2	$D \leftarrow D \text{ (excl. or) } A$	✓	✓	0	0	—	—	
LD/LDB	2	$D \leftarrow A$	—	—	—	—	—	—	
ST/STB	2	$A \leftarrow D$	—	—	—	—	—	—	
LDBSE	2	$D \leftarrow A; D + 1 \leftarrow \text{SIGN}(A)$	—	—	—	—	—	—	3, 4
LDBZE	2	$D \leftarrow A; D + 1 \leftarrow 0$	—	—	—	—	—	—	3, 4
PUSH	1	$SP \leftarrow SP - 2; (SP) \leftarrow A$	—	—	—	—	—	—	
POP	1	$A \leftarrow (SP); SP \leftarrow SP + 2$	—	—	—	—	—	—	
PUSHF	0	$SP \leftarrow SP - 2; (SP) \leftarrow \text{PSW};$ $\text{PSW} \leftarrow 0000\text{H} \quad I \leftarrow 0$	0	0	0	0	0	0	
POPF	0	$\text{PSW} \leftarrow (SP); SP \leftarrow SP + 2; I \leftarrow \text{✓}$	✓	✓	✓	✓	✓	✓	
SJMP	1	$PC \leftarrow PC + 11\text{-bit offset}$	—	—	—	—	—	—	5
LJMP	1	$PC \leftarrow PC + 16\text{-bit offset}$	—	—	—	—	—	—	5
BR (indirect)	1	$PC \leftarrow (A)$	—	—	—	—	—	—	
SCALL	1	$SP \leftarrow SP - 2; (SP) \leftarrow PC;$ $PC \leftarrow PC + 11\text{-bit offset}$	—	—	—	—	—	—	5
LCALL	1	$SP \leftarrow SP - 2; (SP) \leftarrow PC;$ $PC \leftarrow PC + 16\text{-bit offset}$	—	—	—	—	—	—	5
RET	0	$PC \leftarrow (SP); SP \leftarrow SP + 2$	—	—	—	—	—	—	
J (conditional)	1	$PC \leftarrow PC + 8\text{-bit offset (if taken)}$	—	—	—	—	—	—	5
JC	1	Jump if C = 1	—	—	—	—	—	—	5
JNC	1	Jump if C = 0	—	—	—	—	—	—	5
JE	1	Jump if Z = 1	—	—	—	—	—	—	5

**NOTES:**

1. If the mnemonic ends in "B", a byte operation is performed, otherwise a word operation is done. Operands D, B, and A must conform to the alignment rules for the required operand type. D and B are locations in the register file; A can be located anywhere in memory.
2. D, D + 2 are consecutive WORDS in memory; D is DOUBLE-WORD aligned.
3. D, D + 1 are consecutive BYTES in memory; D is WORD aligned.
4. Changes a byte to a word.
5. Offset is a 2's complement number.

**Instruction Summary (Continued)**

Mnemonic	Operands	Operation (Note 1)	Flags						Notes
			Z	N	C	V	VT	ST	
JNE	1	Jump if Z = 0	—	—	—	—	—	—	5
JGE	1	Jump if N = 0	—	—	—	—	—	—	5
JLT	1	Jump if N = 1	—	—	—	—	—	—	5
JGT	1	Jump if N = 0 and Z = 0	—	—	—	—	—	—	5
JLE	1	Jump if N = 1 or Z = 1	—	—	—	—	—	—	5
JH	1	Jump if C = 1 and Z = 0	—	—	—	—	—	—	5
JNH	1	Jump if C = 0 or Z = 1	—	—	—	—	—	—	5
JV	1	Jump if V = 1	—	—	—	—	—	—	5
JNV	1	Jump if V = 0	—	—	—	—	—	—	5
JVT	1	Jump if VT = 1; Clear VT	—	—	—	—	0	—	5
JNVT	1	Jump if VT = 0; Clear VT	—	—	—	—	0	—	5
JST	1	Jump if ST = 1	—	—	—	—	—	—	5
JNST	1	Jump if ST = 0	—	—	—	—	—	—	5
JBS	3	Jump if Specified Bit = 1	—	—	—	—	—	—	5,6
JBC	3	Jump if Specified Bit = 0	—	—	—	—	—	—	5,6
DJNZ	1	D ← D - 1; if D ≠ 0 then PC ← PC + 8-bit offset	—	—	—	—	—	—	5
DEC/DECB	1	D ← D - 1	✓	✓	✓	✓	↑	—	
NEG/NEGB	1	D ← 0 - D	✓	✓	✓	✓	↑	—	
INC/INCB	1	D ← D + 1	✓	✓	✓	✓	↑	—	
EXT	1	D ← D; D + 2 ← Sign (D)	✓	✓	0	0	—	—	2
EXTB	1	D ← D; D + 1 ← Sign (D)	✓	✓	0	0	—	—	3
NOT/NOTB	1	D ← Logical Not (D)	✓	✓	0	0	—	—	
CLR/CLRB	1	D ← 0	1	0	0	0	—	—	
SHL/SHLB/SHLL	2	C ← msb ———— lsb ← 0	✓	?	✓	✓	↑	—	7
SHR/SHRB/SHRL	2	0 → msb ———— lsb → C	✓	?	✓	0	—	✓	7
SHRA/SHRAB/SHRAL	2	msb → msb ———— lsb → C	✓	✓	✓	0	—	✓	7
SETC	0	C ← 1	—	—	1	—	—	—	
CLRC	0	C ← 0	—	—	0	—	—	—	
CLRV	0	VT ← 0	—	—	—	—	0	—	
RST	0	PC ← 2080H	0	0	0	0	0	0	8
DI	0	Disable All Interrupts (I ← 0)	—	—	—	—	—	—	
EI	0	Enable All Interrupts (I ← 1)	—	—	—	—	—	—	
NOP	0	PC ← PC + 1	—	—	—	—	—	—	
SKIP	0	PC ← PC + 2	—	—	—	—	—	—	
NORML	2	Left Shift Till msb = 1; D ← shift count	✓	?	0	—	—	—	7
TRAP	0	SP ← SP - 2; (SP) ← PC PC ← (2010H)	—	—	—	—	—	—	9

**NOTES:**

- If the mnemonic ends in "B", a byte operation is performed, otherwise a word operation is done. Operands D, B, and A must conform to the alignment rules for the required operand type. D and B are locations in the register file; A can be located anywhere in memory.
- Offset is a 2's complement number.
- Specified bit is one of the 2048 bits in the register file.
- The "L" (Long) suffix indicates double-word operation.
- Initiates a Reset by pulling RESET low. Software should re-initialize all the necessary registers with code starting at 2080H.
- The assembler will not accept this mnemonic.

MNEMONIC	OPERANDS	DIRECT			IMMEDIATE			INDIRECT <sup>Ⓞ</sup>					INDEXED <sup>Ⓞ</sup>				
		OPCODE	BYTES	STATE TIMES	OPCODE	BYTES	STATE TIMES	NORMAL			AUTO-INC.		SHORT			LONG	
								OPCODE	BYTES	STATE TIMES	BYTES	STATE TIMES	OPCODE	BYTES	STATE TIMES	BYTES	STATE TIMES
<b>ARITHMETIC INSTRUCTIONS</b>																	
ADD	2	64	3	4	65	4	5	66	3	6/11	3	7/12	67	4	6/11	5	7/12
ADD	3	44	4	5	45	5	6	46	4	7/12	4	8/13	47	5	7/12	6	8/13
ADDB	2	74	3	4	75	3	4	76	3	6/11	3	7/12	77	4	6/11	5	7/12
ADDB	3	54	4	5	55	4	5	56	4	7/12	4	8/13	57	5	7/12	6	8/13
ADDC	2	A4	3	4	A5	4	5	A6	3	6/11	3	7/12	A7	4	6/11	5	7/12
ADDCB	2	B4	3	4	B5	3	4	B6	3	6/11	3	7/12	B7	4	6/11	5	7/12
SUB	2	68	3	4	69	4	5	6A	3	6/11	3	7/12	6B	4	6/11	5	7/12
SUB	3	48	4	5	49	5	6	4A	4	7/12	4	8/13	4B	5	7/12	6	8/13
SUBB	2	78	3	4	79	3	4	7A	3	6/11	3	7/12	7B	4	6/11	5	7/12
SUBB	3	58	4	5	59	4	5	5A	4	7/12	4	8/13	5B	5	7/12	6	8/13
SUBC	2	A8	3	4	A9	4	5	AA	3	6/11	3	7/12	AB	4	6/11	5	7/12
SUBCB	2	B8	3	4	B9	3	4	BA	3	6/11	3	7/12	BB	4	6/11	5	7/12
CMP	2	88	3	4	89	4	5	8A	3	6/11	3	7/12	8B	4	6/11	5	7/12
CMPB	2	98	3	4	99	3	4	9A	3	6/11	3	7/12	9B	4	6/11	5	7/12
MULU	2	6C	3	25	6D	4	26	6E	3	27/32	3	28/33	6F	4	27/32	5	28/33
MULU	3	4C	4	26	4D	5	27	4E	4	28/33	4	29/34	4F	5	28/33	6	29/34
MULUB	2	7C	3	17	7D	3	17	7E	3	19/24	3	20/25	7F	4	19/24	5	20/25
MULUB	3	5C	4	18	5D	4	18	5E	4	20/25	4	21/26	5F	5	20/25	6	21/26
MUL	2	Ⓞ	4	29	Ⓞ	5	30	Ⓞ	4	31/36	4	32/37	Ⓞ	5	31/36	6	32/37
MUL	3	Ⓞ	5	30	Ⓞ	6	31	Ⓞ	5	32/37	5	33/38	Ⓞ	6	32/37	7	33/38
MULB	2	Ⓞ	4	21	Ⓞ	4	21	Ⓞ	4	23/28	4	24/29	Ⓞ	5	23/28	6	24/29
MULB	3	Ⓞ	5	22	Ⓞ	5	22	Ⓞ	5	24/29	5	25/30	Ⓞ	6	24/29	7	25/30
DIVU	2	8C	3	25	8D	4	26	8E	3	28/32	3	29/33	8F	4	28/32	5	29/33
DIVUB	2	9C	3	17	9D	3	17	9E	3	20/24	3	21/25	9F	4	20/24	5	21/25
DIV	2	Ⓞ	4	29	Ⓞ	5	30	Ⓞ	4	32/36	4	33/37	Ⓞ	5	32/36	6	33/37
DIVB	2	Ⓞ	4	21	Ⓞ	4	21	Ⓞ	4	24/28	4	25/29	Ⓞ	5	24/28	6	25/29

270014-9

**NOTES:**

\* Long indexed and Indirect + instructions have identical opcodes with Short indexed and Indirect modes, respectively. The second byte of instructions using any indirect or indexed addressing mode specifies the exact mode used. If the second byte is even, use Indirect or Short Indexed. If it is odd, use Indirect+ or Long Indexed. In all cases the second byte of the instruction always specifies an even (word) location for the address referenced.

1. Number of state times shown for internal/external operands.

2. The opcodes for signed multiply and divide are the opcodes for the unsigned functions with an "FE" appended as a prefix.

3. State times shown for 16-bit bus.

MNEMONIC	OPERANDS	DIRECT			IMMEDIATE			INDIRECT <sup>Ⓞ</sup>					INDEXED <sup>Ⓞ</sup>				
		OPCODE	BYTES	STATE TIMES	OPCODE	BYTES	STATE TIMES	NORMAL			AUTO-INC.		SHORT			LONG	
								OPCODE	BYTES	STATE <sup>Ⓞ</sup> TIMES	BYTES	STATE <sup>Ⓞ</sup> TIMES	OPCODE	BYTES	STATE <sup>Ⓞ</sup> TIMES	BYTES	STATE <sup>Ⓞ</sup> TIMES
<b>LOGICAL INSTRUCTIONS</b>																	
AND	2	60	3	4	61	4	5	62	3	6/11	3	7/12	63	4	6/11	5	7/12
AND	3	40	4	5	41	5	6	42	4	7/12	4	8/13	43	5	7/12	6	8/13
ANDB	2	70	3	4	71	3	4	72	3	6/11	3	7/12	73	4	6/11	5	7/12
ANDB	3	50	4	5	51	4	5	52	4	7/12	4	8/13	53	5	7/12	6	8/13
OR	2	80	3	4	81	4	5	82	3	6/11	3	7/12	83	4	6/11	5	7/12
ORB	2	90	3	4	91	3	4	92	3	6/11	3	7/12	93	4	6/11	5	7/12
XOR	2	84	3	4	85	4	5	86	3	6/11	3	7/12	87	4	6/11	5	7/12
XORB	2	94	3	4	95	3	4	96	3	6/11	3	7/12	97	4	6/11	5	7/12
<b>DATA TRANSFER INSTRUCTIONS</b>																	
LD	2	A0	3	4	A1	4	5	A2	3	6/11	3	7/12	A3	4	6/11	5	7/12
LDB	2	B0	3	4	B1	3	4	B2	3	6/11	3	7/12	B3	4	6/11	5	7/12
ST	2	C0	3	4	—	—	—	C2	3	7/11	3	8/12	C3	4	7/11	5	8/12
STB	2	C4	3	4	—	—	—	C6	3	7/11	3	8/12	C7	4	7/11	5	8/12
LDBSE	2	BC	3	4	BD	3	4	BE	3	6/11	3	7/12	BF	4	6/11	5	7/12
LDBZE	2	AC	3	4	AD	3	4	AE	3	6/11	3	7/12	AF	4	6/11	5	7/12
<b>STACK OPERATIONS (internal stack)</b>																	
PUSH	1	C8	2	8	C9	3	8	CA	2	11/15	2	12/16	CB	3	11/15	4	12/16
POP	1	CC	2	12	—	—	—	CE	2	14/18	2	14/18	CF	3	14/18	4	14/18
PUSHF	0	F2	1	8													
POPF	0	F3	1	9													
<b>STACK OPERATIONS (external stack)</b>																	
PUSH	1	C8	2	12	C9	3	12	CA	2	15/19	2	16/20	CB	3	15/19	4	16/20
POP	1	CC	2	14	—	—	—	CE	2	16/20	2	16/20	CF	3	16/20	4	16/20
PUSHF	0	F2	1	12													
POPF	0	F3	1	13													
<b>JUMPS AND CALLS</b>																	
MNEMONIC	OPCODE	BYTES	STATES	MNEMONIC	OPCODE	BYTES	STATES										
LJMP	E7	3	8	LCALL	EF	3	13/16 <sup>Ⓞ</sup>										
SJMP	20-27 <sup>Ⓞ</sup>	2	8	SCALL	28-2F <sup>Ⓞ</sup>	2	13/16 <sup>Ⓞ</sup>										
BR[ ]	E3	2	8	RET	F0	1	12/16 <sup>Ⓞ</sup>										
				TRAP <sup>Ⓞ</sup>	F7	1	21/24										

270014-10

**NOTES:**

- Number of state times shown for internal/external operands.
- The assembler does not accept this mnemonic.
- The least significant 3 bits of the opcode are concatenated with the following 8 bits to form an 11-bit, 2's complement, offset for the relative call or jump.
- State times for stack located internal/external.

**Conditional Jumps**

All conditional jumps are 2 byte instructions. They require 8 state times if the jump is taken, 4 if it is not.

Mnemonic	Opcode	Mnemonic	Opcode	Mnemonic	Opcode	Mnemonic	Opcode
JC	DB	JE	DF	JGE	D6	JGT	D2
JNC	D3	JNE	D7	JLT	DE	JLE	DA
JH	D9	JV	DD	JVT	DC	JST	D8
JNH	D1	JNV	D5	JNVT	D4	JNST	D0

**Jump on Bit Clear or Bit Set**

These instructions are 3-byte instructions. They require 9 state times if the jump is taken, 5 if it is not.

Mnemonic	Bit Number							
	0	1	2	3	4	5	6	7
JBC	30	31	32	33	34	35	36	37
JBS	38	39	3A	3B	3C	3D	3E	3F

**LOOP CONTROL**

DJNZ	OPCODE EO;	3 BYTES;	5/9 STATE TIMES (NOT TAKEN/TAKEN)
------	------------	----------	-----------------------------------

**Single Register Instructions**

Mnemonic	Opcode	Bytes	States	Mnemonic	Opcode	Bytes	States
DEC	05	2	4	EXT	06	2	4
DECB	15	2	4	EXTB	16	2	4
NEG	03	2	4	NOT	02	2	4
NEGB	13	2	4	NOTB	12	2	4
INC	07	2	4	CLR	01	2	4
INCB	17	2	4	CLRB	11	2	4

**Shift Instructions**

Instr Mnemonic	Word		Instr Mnemonic	Byte		Instr Mnemonic	DBL WD		State Times
	OP	B		OP	B		OP	B	
SHL	09	3	SHLB	19	3	SHLL	0D	3	7 + 1 PER SHIFT <sup>(7)</sup>
SHR	08	3	SHRB	18	3	SHRL	0C	3	7 + 1 PER SHIFT <sup>(7)</sup>
SHRA	0A	3	SHRAB	1A	3	SHRAL	0E	3	7 + 1 PER SHIFT <sup>(7)</sup>

**Special Control Instructions**

Mnemonic	Opcode	Bytes	States	Mnemonic	Opcode	Bytes	States
SETC	F9	1	4	DI	FA	1	4
CLRC	F8	1	4	EI	FB	1	4
CLRVT	FC	1	4	NOP	FD	1	4
RST (6)	FF	1	166	SKIP	00	2	4

**Normalize**

Mnemonic	Opcode	Bytes	State Times
NORML	0F	3	11 + 1 PER SHIFT

**NOTES:**

- 6. This instruction takes 2 states to pull RST low, then holds it low for 2 states to initiate a reset. The reset takes 12 states, at which time the program restarts at location 2080H.
- 7. Execution will take at least 8 states, even for 0 shift.

## FUNCTIONAL DEVIATIONS

Functional deviations from the 809x and 839x on the 809x-90 and 839x-90.

### CPU Section

1. Indexed, 3 Operand Multiply—The displacement portion of an indexed, three word multiply may not be in the range of 200H thru 17FFH inclusive. This also applies to byte multiples that use 3 operands.
2. Add or Subtract with carry—The zero flag is both set and cleared by these instructions. Zero checking must be done after each operation.
3. EXT—This instruction never sets the N flag, and always sets the Z flag. The EXTB works correctly. Check the flags before executing an EXT instruction. Additionally, having more than two wait states during an EXT (extend word only) instruction may cause the instruction to give an incorrect result.
4. Read-Modify-Write on Interrupt Pending—A read-modify-write instruction on the interrupt pending register may cause interrupts that occur during execution of the instruction to be missed.
5. READY line—The READY line should not be brought low during the execution of an instruction that accesses HSI\_TIME, SP\_STAT or IOS1. It should also not be brought low for a data write during the instruction immediately preceding one of the above operations. Do not use wait states for program memory that holds these instructions. Also place a NOP between writes to slow memory and accesses to HSO\_TIME, SP\_STAT or IOS1.  
The READY line also should not be brought low for more than two state times when using the EXT (extend word) instruction.
6. Signed Divide—The V and VT flags may indicate an overflow after a signed divide when no overflow has occurred.
7. The sticky flag is not affected when a shift by zero is executed on an 8X9X-90.
8. The JBS and JBC instructions should not be used directly on Port 2.1 or any pins of Port 0 if used as digital input. If it is necessary to test these pins, first LD the port data into a temporary register, and then test the bit there.

### HSI/HSO Section

1. HSI Timing—An event occurring within 16 state times of a prior event on the same HSI line may not be recorded. Additionally, an event occurring within 16 state times of a prior event on another HSI line may be recorded with a time tag one count earlier than expected. Events are defined as the condition the line is set to trigger on. The effective resolution is increased to 4  $\mu$ s for such closely spaced events.
2. HSI Divide by 8 Mode—If an event on a pin set to look for every eighth transition occurs less than 16 state times after an event on any other pin, then the divide by 8 event will be recorded twice in the HSI FIFO. The time tag of the duplicate FIFO entry will be equal to that of the initial entry plus one. The programmer's software should detect and discard the second entry.
3. HSO Interrupts—Software timer interrupts cannot be generated by the HSO commands that reset Timer 2 or start an A to D conversion.
4. The first few instructions of an interrupt service routine should check IOS1.7 and exit if the Holding Register is not loaded. This will successfully clear unwanted events.

### Serial Port Section

1. Serial Port Flags—Reading SP\_STAT may not clear the TI or RI flag if that flag was set within two state times prior to the read. In addition, the parity error bit (RPE/RB8) may not be correct if it is read within two state times after RI is set.

Use the following code to replace ORB sp\_image, SP\_STAT.

```
SP_READ:
    LDB TEMP, SP_STAT
    ORB SP_IMAGE, SP_STAT
    JBS TEMP,5,SP_READ ; if TI bit is set
                        ; then read again
    JBS TEMP,6,SP_READ ; if RI bit is set
                        ; then read again
    ANDB SP_IMAGE,#7FH ; clear false
                        ; RB8/RPE
    ORB SP_IMAGE,TEMP ; load correct
                        ; RB8/RPE
```

2. Serial Port Mode 0—The serial port is not tested in mode 0. The receive function in this mode does not work correctly. The receive function will not work unless the first bit shifted in is a one.

3. **Serial Port Baud Value**—Loading the baud rate register with 8000H (maximum baud rate, internal clock) may cause an 11 millisecond delay (at  $F_{osc} = 12 \text{ MHz}$ ) before the port is properly initialized. After initialization the port works properly. Include a 44000 state time delay after writing 8000H to the Baud Rate Register.

### Standard I/O Section

1. **Ports 3 and 4 (Internal Execution Mode Only)**—To be used as outputs, Ports 3 and 4 each must be addressed as words but written to as bytes. To write to Port 3 use "ST temp, 1ffeh", where the low byte of "temp" contains the data for the port.

To write to Port 4, use the DCB operator to generate the opcode sequence "0C3H, 001H, 0FFH, 01FH, (temp)", where the high byte of "temp" contains the data for the port. Ports 3 and 4 will not work as input ports.

Also, when writing to Ports 3 and 4, the address of the port, (1FFEh, 1FFFh) will appear on the bus pins for 2 oscillator periods before the new data is presented to the pins. Since normal bus control signals (ALE, RD, etc.) are suppressed during writes to these addresses, there is no way to latch the data and prevent this address "glitch" to the outside world. If this presents a problem in an application, port reconstruction must be done at another address as described in the MCS-96 Hardware Design Information Chapter.



**ABSOLUTE MAXIMUM RATINGS\***

Ambient Temperature Under Bias . . . . .0°C to +70°C  
 Storage Temperature . . . . . -40°C to +150°C  
 Voltage from Any Pin to  
     V<sub>SS</sub> or ANGND . . . . . -0.3V to +7.0V  
 Average Output Current from Any Pin . . . . . 10 mA  
 Power Dissipation . . . . . 1.5 Watts

*\*Notice: Stresses above those listed under "Absolute Maximum Ratings" may cause permanent damage to the device. This is a stress rating only and functional operation of the device at these or any other conditions above those indicated in the operational sections of this specification is not implied. Exposure to absolute maximum rating conditions for extended periods may affect device reliability.*

**NOTICE:** Specifications contained within the following tables are subject to change.

**OPERATING CONDITIONS**

Symbol	Parameter	Min	Max	Units
T <sub>A</sub>	Ambient Temperature Under Bias	0	+70	C
V <sub>CC</sub>	Digital Supply Voltage	4.50	5.50	V
V <sub>REF</sub>	Analog Supply Voltage	4.5	5.5	V
f <sub>OSC</sub>	Oscillator Frequency	6.0	12	MHz
V <sub>PD</sub>	Power-Down Supply Voltage	4.50	5.50	V

**NOTE:**

V<sub>BB</sub> should be connected to ANGND through a 0.01 μF capacitor. ANGND and V<sub>SS</sub> should be nominally at the same potential.

**D.C. CHARACTERISTICS**

Symbol	Parameter	Min	Max	Units	Test Conditions
V <sub>IL</sub>	Input Low Voltage (Except RESET)	-0.3	+0.8	V	
V <sub>IL1</sub>	Input Low Voltage, RESET	-0.3	+0.7	V	
V <sub>IH</sub>	Input High Voltage (Except RESET, NMI, XTAL1)	2.0	V <sub>CC</sub> + 0.5	V	
V <sub>IH1</sub>	Input High Voltage, RESET Rising	2.4	V <sub>CC</sub> + 0.5	V	
V <sub>IH2</sub>	Input High Voltage, RESET Falling	2.1	V <sub>CC</sub> + 0.5	V	
V <sub>IH3</sub>	Input High Voltage, NMI, XTAL1	2.4	V <sub>CC</sub> + 0.5	V	
V <sub>OL</sub>	Output Low Voltage		0.45	V	(Note 1)
V <sub>OH</sub>	Output High Voltage	2.4		V	(Note 2)
I <sub>CC</sub>	V <sub>CC</sub> Supply Current		200	mA	All Outputs Disconnected
I <sub>PD</sub>	VPD Supply Current		1	mA	Normal operation and Power-Down
I <sub>REF</sub>	V <sub>REF</sub> Supply Current		8	mA	
I <sub>LI</sub>	Input Leakage Current to all pins of HSI, P3, P4, and to P2.1		±10	μA	V <sub>IN</sub> = 0 to V <sub>CC</sub>
I <sub>LI1</sub>	Input Leakage to Port 0		±3	μA	V <sub>IN</sub> = 0 to V <sub>CC</sub>
I <sub>IH</sub>	Input High Current to EA		100	μA	V <sub>IH</sub> = 2.4V
I <sub>IL</sub>	Input Low Current to all pins of P1, and to P2.6, P2.7		-100	μA	V <sub>IL</sub> = 0.45V
I <sub>IL1</sub>	Input Low Current to RESET	0.3	-2	mA	V <sub>IL</sub> = 0.45V
I <sub>IL2</sub>	Input Low Current P2.2, P2.3, P2.4, READY		-50	μA	V <sub>IL</sub> = 0.45V
C <sub>S</sub>	Pin Capacitance (Any Pin to V <sub>SS</sub> )		10	pF	f <sub>TEST</sub> = 1.0 MHz

**NOTES:**

- I<sub>OL</sub> = 0.4 mA for all pins of P1, for P2.6 and P2.7, and for all pins of P3 and P4 when used as ports. I<sub>OL</sub> = 2.0 mA for TXD, RXD (in serial port mode 0), PWM, CLKOUT, ALE, BHE, RD, WR, and RESET and all pins of HSO and P3 and P4 when used as external memory bus (AD0-AD15).
- I<sub>OH</sub> = -20 μA for all pins of P1, for P2.6 and P2.7. I<sub>OH</sub> = -200 μA for TXD, RXD (in serial port mode 0), PWM, CLKOUT, ALE, BHE, WR, and all pins of HSO and P3 and P4 when used as external memory bus (AD0-AD15). P3 and P4, when used as ports, have open-drain outputs.

## A/D CONVERTER SPECIFICATIONS

A/D Converter operation is verified only on the 8097, 8397, 8095, 8395.

The absolute conversion accuracy is dependent on the accuracy of VREF. The specifications given below assume adherence to the Operating Conditions section of these data sheets. Testing is done at VREF = 5.120V.

Resolution .....	$\pm 0.001$ VREF
Accuracy .....	$\pm 0.004$ VREF
Differential nonlinearity .....	$\pm 0.002$ VREF max
Integral nonlinearity .....	$\pm 0.004$ VREF max
Channel-to-channel matching .....	$\pm 1$ LSB
Crosstalk (DC to 100 KHz) .....	-60 dB max

## A.C. CHARACTERISTICS

(VCC, VPD = 4.5 to 5.5 Volts; T<sub>A</sub> = 0°C to 70°C; fosc = 6.0 to 12.0 MHz)

Test Conditions: Load Capacitance on Output Pins = 80 pF

Oscillator Frequency = 12.00 MHz

www.DataSheet4U.com

### TIMING REQUIREMENTS (Other system components must meet these specs.)

Symbol	Parameter	Min	Max	Units
TCLYX	READY Hold after CLKOUT Edge	0		ns
TLLYV	End of ALE to READY Setup	-Tosc	2Tosc-60	ns
TLLYH	End of ALE to READY High	2Tosc+40	4Tosc-60(1)	ns
TYLYH	Non-ready Time		1000	ns
TAVDV	Address Valid to Input Data Valid		5Tosc-90	ns
TRLDV	RD/Active to Input Data Valid		3Tosc-60	ns
TRXDX	Data Hold after RD/inactive(2)	0		ns
TRXDZ	RD/Inactive to Input Data Float(2)		Tosc-20	ns

### TIMING RESPONSES (MCS-96 parts meet these specs.)

Symbol	Parameter	Min	Max	Units
FXTAL	Oscillator Frequency	6.00	12.00	MHz
Tosc	Oscillator Period	83	166	ns
TOHCH	Oscillator High to CLKOUT High(3)	0	120	ns
TCHCH	CLKOUT Period(2)	3Tosc(3)	3Tosc(3)	ns
TCHCL	CLKOUT High Time	Tosc-20	Tosc+20	ns
TCLLH	CLKOUT Low to ALE High	-25	20	ns
TLLCH	ALE Low to CLKOUT High	Tosc-20	Tosc+40	ns
TLHLL	ALE Pulse Width	Tosc-25	Tosc+15	ns
TAVLL	Address Setup to End of ALE	Tosc-50		ns
TLLRL	End of ALE to RD/ or WR/ Active	Tosc-20		ns
TLLAX	Address Hold After End of ALE	Tosc-20		ns
TWLWH	WR/ Pulse Width	2Tosc-35		ns
TQVWX	Output Data Setup to End of WR/	2Tosc-60		ns
TWXQX	Output Data Hold After End of WR/	Tosc-25		ns
TWXLH	End of WR/ to Next ALE	2Tosc-30		ns
TRLRH	RD/ Pulse Width	3Tosc-30		ns
TRHLH	End of RD/ to Next ALE	Tosc-25		ns

#### NOTES:

1. If more than one wait state is desired, add 3Tosc for each additional wait state.
2. This specification is not tested, but is verified by design analysis and/or derived from other tested parameters.
3. CLKOUT is directly generated as a divide by 3 of the oscillator. The period will be 3Tosc  $\pm$  10 ns if T<sub>osc</sub> is constant and the rise and fall times on XTAL 1 are less than 10 ns. CLKOUT is not bonded out on 48-pin parts.

WAVEFORM

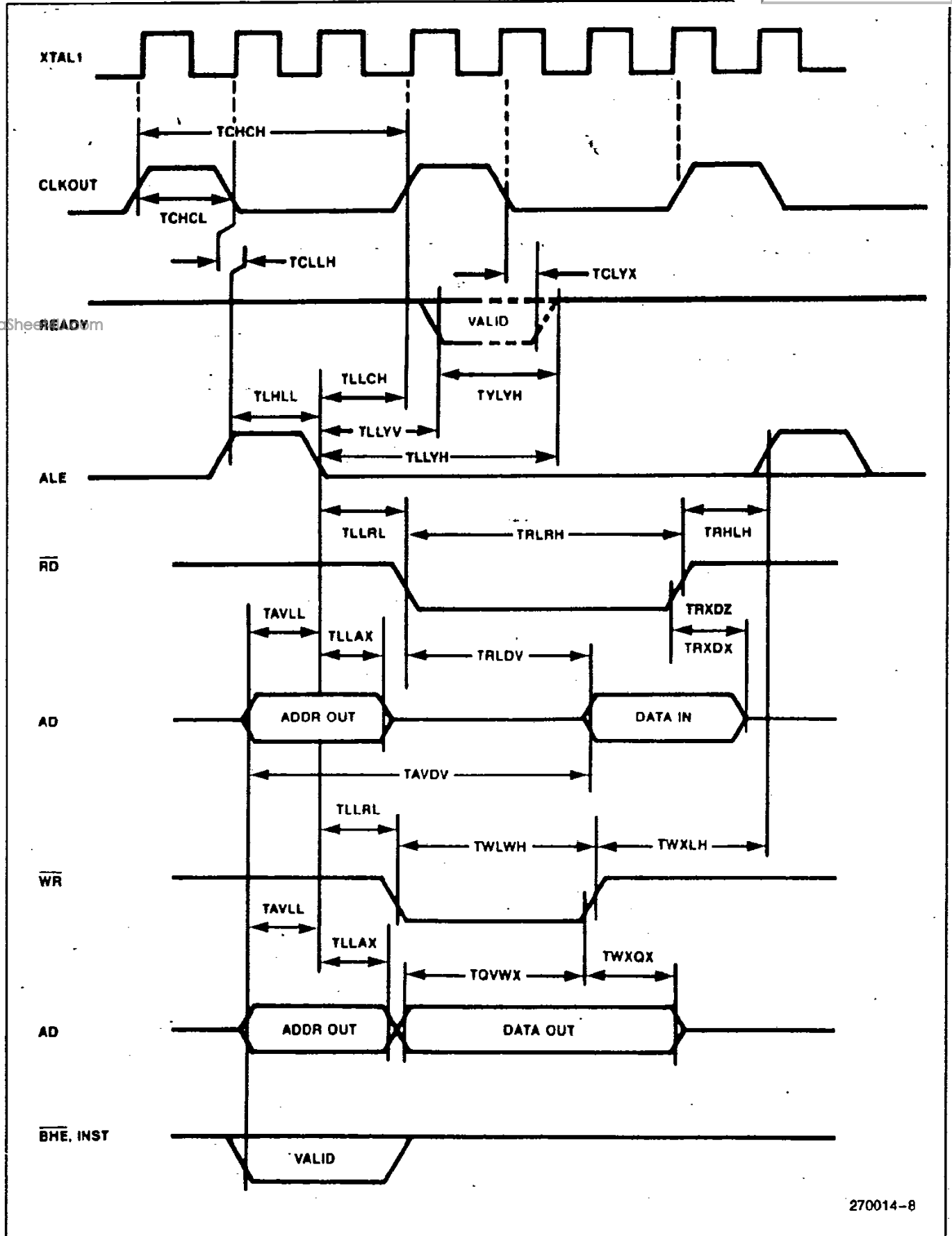

270014-8

Bus Signal Timings