



## 81CXX/81NXX

CMOS IC

### VOLTAGE DETECTORS WITH BUILT-IN DELAY TIME

#### DESCRIPTION

The UTC **81CXX** and **81NXX** series are good performance voltage detector and manufactured by CMOS technologies with highly accurate, low power consumption. A delay circuit is built-in to each detector, therefore, peripherals are unnecessary and high density mounting is possible. Detect voltage is extremely accurate with minimal temperature drift. Both CMOS and N-channel open drain output configurations are available.

#### FEATURES

- \* Highly Accurate: Detect voltage  $\pm 2\%$
- \* Built-In Delay time : 1ms ~ 50ms  
50ms ~ 200ms  
200ms ~ 400ms
- \* Detect Voltage Temperature Characteristics: TYP  $\pm 100\text{ppm}/^\circ\text{C}$
- \* Wide Operating Voltage Range : 0.7V ~ 10.0V
- \* Low Current Consumption : TYP 1.0 $\mu\text{A}$  ( $V_{\text{IN}}=2.0\text{V}$ )

#### ORDERING INFORMATION

##### CMOS:

Ordering Number		①:Delay Time			Package	Pin Assignment			Packing
Lead Free	Halogen Free	Duration		Code		1	2	3	
-	81CXXG-①-AA3-B-R	1~50 50~200 200~400	ms ms ms	P Q R	SOT-223	O	G	I	Tape Reel
-	81CXXG-①-AB3-E-R				SOT-89	O	I	G	Tape Reel
-	81CXXG-①-AE3-3-R				SOT-23	O	G	I	Tape Reel
-	81CXXG-①-AE3-5-R				SOT-23	G	O	I	Tape Reel
-	81CXXG-①-AE3-2-R				SOT-23	I	O	G	Tape Reel
81CXXL-①-T92-D-B	81CXXG-①-T92-D-B				TO-92	I	G	O	Tape Box
81CXXL-①-T92-E-B	81CXXG-①-T92-E-B				TO-92	O	I	G	Tape Box
81CXXL-①-T92-D-K	81CXXG-①-T92-D-K				TO-92	I	G	O	Bulk
81CXXL-①-T92-E-K	81CXXG-①-T92-E-K				TO-92	O	I	G	Bulk

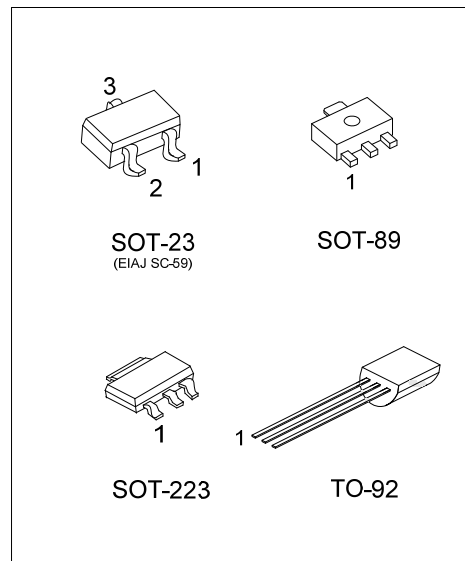

■ ORDERING INFORMATION(Cont.)

**N-Channel:**

Ordering Number		①:Delay Time			Package	Pin Assignment			Packing
Lead Free	Halogen Free	Duration		Code		1	2	3	
-	81NXXG-①-AA3-B-R	1~50 50~200 200~400	ms ms ms	H J K	SOT-223	O	G	I	Tape Reel
-	81NXXG-①-AB3-E-R				SOT-89	O	I	G	Tape Reel
-	81NXXG-①-AE3-3-R				SOT-23	O	G	I	Tape Reel
-	81NXXG-①-AE3-5-R				SOT-23	G	O	I	Tape Reel
-	81NXXG-①-AE3-2-R				SOT-23	I	O	G	Tape Reel
81NXXL-①-T92-D-B	81NXXG-①-T92-D-B				TO-92	I	G	O	Tape Box
81NXXL-①-T92-E-B	81NXXG-①-T92-E-B				TO-92	O	I	G	Tape Box
81NXXL-①-T92-D-K	81NXXG-①-T92-D-K				TO-92	I	G	O	Bulk
81NXXL-①-T92-E-K	81NXXG-①-T92-E-K				TO-92	O	I	G	Bulk

Note: 1. Pin assignment: I:V<sub>IN</sub> O:V<sub>OUT</sub> G:V<sub>SS</sub>

2. XX: Output Voltage, refer to Marking Information.

<p>81CXXG-①-AA3-x-R</p>	<ul style="list-style-type: none"> <li>(1)Packing Type</li> <li>(2)Pin Code</li> <li>(3)Package Type</li> <li>(4)Delay Time</li> <li>(5)Green Package</li> <li>(6)Output Voltage Code</li> <li>(7)Output Configuration</li> </ul>	<ul style="list-style-type: none"> <li>(1) R: Tape Reel, B: Tape Box, K: Bulk</li> <li>(2) refer to Pin Assignment</li> <li>(3) AA3: SOT-223, AB3: SOT-89, AE3: SOT-23, T92: TO-92</li> <li>(4) ① : refer to Delay Time</li> <li>(5) G: Halogen Free and Lead Free, L: Lead Free</li> <li>(6) XX: refer to Marking Information</li> <li>(7) C: CMOS, N: N-Channel</li> </ul>
-------------------------	---	--

## MARKING INFORMATION

PACKAGE	VOLTAGE CODE			MARKING
SOT-223	10:1.0V	26:2.6V	42:4.2V	
	11:1.1V	27:2.7V		
	12:1.2V	28:2.8V		
	13:1.3V	29:2.9V		
	14:1.4V	30:3.0V		
SOT-89	15:1.5V	31:3.1V	43:4.3V	
	16:1.6V	32:3.2V		
	17:1.7V	33:3.3V		
	18:1.8V	34:3.4V		
	19:1.9V	35:3.5V		
TO-92	20:2.0V	36:3.6V	44:4.4V	
	21:2.1V	37:3.7V		
	22:2.2V	38:3.8V		
	23:2.3V	39:3.9V		
	24:2.4V	40:4.0V		
	25:2.5V	41:4.1V		
		50:5.0V		

PACKAGE	INTEGER (Note 1)	CODE	DECIMAL (Note 2)	CODE	MARKING
SOT-23	1.	1	.0	A	
	2.	2	.1	B	
	3.	3	.2	C	
	4.	4	.3	D	
	5.	5	.4	E	
	6.	6	.5	F	
			.6	G	
			.7	H	
			.8	J	
			.9	K	

Notes: 1. Represents the integer of the Detect Voltage  
 2. Represents the decimal number of the Detect Voltage

## EXAMPLE:

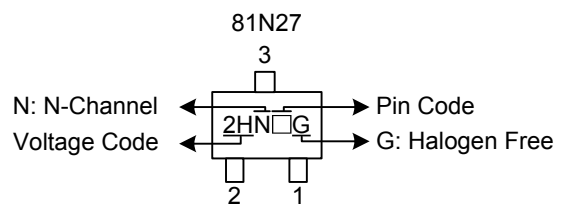
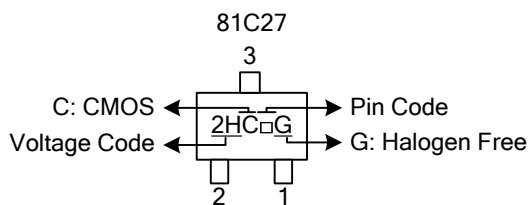

■ BLOCK DIAGRAM

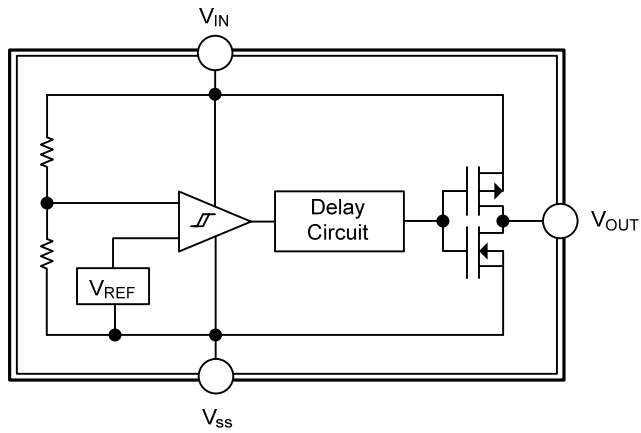

CMOS Output

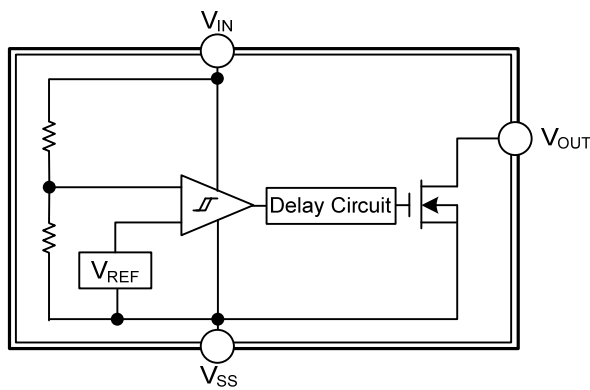

N-channel Open Drain Output

### ■ ABSOLUTE MAXIMUM RATINGS (T<sub>A</sub>=25°C)

PARAMETER		SYMBOL	RATINGS	UNIT
Input Voltage		V <sub>IN</sub>	10	V
Output Current		I <sub>OUT</sub>	50	mA
Output Voltage	CMOS	V <sub>OUT</sub>	V <sub>SS</sub> -0.3 ~ V <sub>IN</sub> +0.3	V
	N-Ch open drain		V <sub>SS</sub> -0.3 ~ 9	V
Power Dissipation	SOT-223	P <sub>D</sub>	800	mW
	SOT-23		150	
	SOT-89		500	
	TO-92		300	
Operating Temperature		T <sub>OPR</sub>	-30 ~ +85	°C
Storage Temperature		T <sub>STG</sub>	-40 ~ +125	°C

Note Absolute maximum ratings are those values beyond which the device could be permanently damaged. Absolute maximum ratings are stress ratings only and functional device operation is not implied.

### ■ THERMAL DATA

PARAMETER		SYMBOL	RATINGS	UNIT
Junction to Case	SOT-223	θ <sub>JC</sub>	20	°C/W
	SOT-23		200	
	SOT-89		45	
	TO-92		100	

### ■ ELECTRICAL CHARACTERISTICS (T<sub>A</sub>=25°C)

#### Detection voltage (1.0V ~ 1.9V)

PARAMETER	SYMBOL	CIRCUIT	TEST CONDITIONS	MIN	TYP	MAX	UNIT
Detect Voltage	V <sub>DF</sub>	1		V <sub>DF</sub> (T) ×0.98	V <sub>DF</sub> (T)	V <sub>DF</sub> (T) ×1.02	V
Hysteresis Range	V <sub>HYS</sub>	1		V <sub>DF</sub> ×0.02	V <sub>DF</sub> ×0.05	V <sub>DF</sub> ×0.08	V
Operating Voltage	V <sub>IN</sub>	1	V <sub>DF</sub> =1.6V ~ 6.0V	0.7		10.0	V
Supply Current	I <sub>SS</sub>	2	V <sub>IN</sub> =1.5V		0.9	2.6	μA
			V <sub>IN</sub> =5.0		2.0	4.2	μA
Output Current	N-Channel	I <sub>OUT</sub>	3	V <sub>DS</sub> =0.5V, V <sub>IN</sub> =1.0V		2.2	mA
	P- Channel						
V <sub>DF</sub> Temperature Characteristics	ΔV <sub>DF</sub> ΔT <sub>OPR</sub> × V <sub>DF</sub>				±100		ppm/°C
Transient Delay Time (V <sub>DR</sub> → V <sub>OUT</sub> inversion)	t <sub>DLY</sub> *	5	V <sub>IN</sub> changes from 0.6V ~ 10V	50		200	ms

■ ELECTRICAL CHARACTERISTICS(Cont.)

**Detection voltage (2.0V ~ 2.9V)**

PARAMETER		SYMBOL	CIRCUIT	TEST CONDITIONS	MIN	TYP	MAX	UNIT
Detect Voltage		$V_{DF}$	1		$V_{DF} (T) \times 0.98$	$V_{DF} (T)$	$V_{DF} (T) \times 1.02$	V
Hysteresis Range		$V_{HYS}$	1		$V_{DF} \times 0.02$	$V_{DF} \times 0.05$	$V_{DF} \times 0.08$	V
Operating Voltage		$V_{IN}$	1	$V_{DF}=1.6V \sim 6.0V$	0.7		10.0	V
Supply Current		$I_{SS}$	2	$V_{IN}=2.0V$		1.0	3.0	$\mu A$
				$V_{IN}=5.0V$		2.0	4.2	$\mu A$
Output Current	N-Channel	$I_{OUT}$	3	$V_{DS}=0.5V, V_{IN}=2.0V$		7.9		mA
	P- Channel		4	$V_{DS}=2.1V, V_{IN}=8.0V$ (CMOS output)		-15.4		mA
$V_{DF}$ Temperature Characteristics		$\frac{\Delta V_{DF}}{\Delta T_{OPR} \times V_{DF}}$				$\pm 100$		ppm/ $^{\circ}C$
Transient Delay Time ( $V_{DR} \rightarrow V_{OUT}$ inversion)		$t_{DLY}^*$	5	$V_{IN}$ changes from 0.6V ~ 10V	50		200	ms

**Detection voltage (3.0V ~ 3.9V)**

PARAMETER		SYMBOL	CIRCUIT	TEST CONDITIONS	MIN	TYP	MAX	UNIT
Detect Voltage		$V_{DF}$	1		$V_{DF} (T) \times 0.98$	$V_{DF} (T)$	$V_{DF} (T) \times 1.02$	V
Hysteresis Range		$V_{HYS}$	1		$V_{DF} \times 0.02$	$V_{DF} \times 0.05$	$V_{DF} \times 0.08$	V
Operating Voltage		$V_{IN}$	1	$V_{DF}=1.6V \sim 6.0V$	0.7		10.0	V
Supply Current		$I_{SS}$	2	$V_{IN}=3.0V$		1.3	3.4	$\mu A$
				$V_{IN}=5.0V$		2.0	4.2	$\mu A$
Output Current	N-Channel	$I_{OUT}$	3	$V_{DS}=0.5V, V_{IN}=3.0V$		10.1		mA
	P- Channel		4	$V_{DS}=2.1V, V_{IN}=8.0V$ (CMOS output)		-15.4		mA
$V_{DF}$ Temperature Characteristics		$\frac{\Delta V_{DF}}{\Delta T_{OPR} \times V_{DF}}$				$\pm 100$		ppm/ $^{\circ}C$
Transient Delay Time ( $V_{DR} \rightarrow V_{OUT}$ inversion)		$t_{DLY}^*$	5	$V_{IN}$ changes from 0.6V ~ 10V	50		200	ms

**Detection voltage (4.0V ~ 4.9V)**

PARAMETER		SYMBOL	CIRCUIT	TEST CONDITIONS	MIN	TYP	MAX	UNIT
Detect Voltage		$V_{DF}$	1		$V_{DF} (T) \times 0.98$	$V_{DF} (T)$	$V_{DF} (T) \times 1.02$	V
Hysteresis Range		$V_{HYS}$	1		$V_{DF} \times 0.02$	$V_{DF} \times 0.05$	$V_{DF} \times 0.08$	V
Operating Voltage		$V_{IN}$	1	$V_{DF}=1.6V \sim 6.0V$	0.7		10.0	V
Supply Current		$I_{SS}$	2	$V_{IN}=4.0V$		1.5	3.8	$\mu A$
				$V_{IN}=5.0V$		2.0	4.2	$\mu A$
Output Current	N-Channel	$I_{OUT}$	3	$V_{DS}=0.5V, V_{IN}=4.0V$		11.5		mA
	P- Channel		4	$V_{DS}=2.1V, V_{IN}=8.0V$ (CMOS output)		-15.4		mA
$V_{DF}$ Temperature Characteristics		$\frac{\Delta V_{DF}}{\Delta T_{OPR} \times V_{DF}}$				$\pm 100$		ppm/ $^{\circ}C$
Transient Delay Time ( $V_{DR} \rightarrow V_{OUT}$ inversion)		$t_{DLY}^*$	5	$V_{IN}$ changes from 0.6V ~ 10V	50		200	ms

■ ELECTRICAL CHARACTERISTICS(Cont.)

**Detection voltage (5.0V)**

PARAMETER	SYMBOL	CIRCUIT	TEST CONDITIONS	MIN	TYP	MAX	UNIT
Detect Voltage	$V_{DF}$	1		$V_{DF}(T) \times 0.98$	$V_{DF}(T)$	$V_{DF}(T) \times 1.02$	V
Hysteresis Range	$V_{HYS}$	1		$V_{DF} \times 0.02$	$V_{DF} \times 0.05$	$V_{DF} \times 0.08$	V
Operating Voltage	$V_{IN}$	1	$V_{DF}=1.6V \sim 6.0V$	0.7		10.0	V
Supply Current	$I_{SS}$	2	$V_{IN}=5.0V$		2.0	4.2	$\mu A$
Output Current	N-Channel	$I_{OUT}$	3	$V_{DS}=0.5V, V_{IN}=5.0V$		13.0	mA
	P- Channel		4	$V_{DS}=2.1V, V_{IN}=8.0V$ (CMOS output)		-15.4	mA
$V_{DF}$ Temperature Characteristics		$\frac{\Delta V_{DF}}{\Delta T_{OPR} \times V_{DF}}$			$\pm 100$		ppm/ $^{\circ}C$
Transient Delay Time ( $V_{DR} \rightarrow V_{OUT}$ inversion)	$t_{DLY}^*$	5	$V_{IN}$ changes from 0.6V ~ 10V	50		200	ms

$V_{DF}(T)$ : established detect voltage value

Release Voltage:  $V_{DR} = V_{DF} + V_{HYS}$

\* Transient Delay Time: 1ms ~ 50ms & 200ms ~ 400ms versions are also available.

Note: The power consumption during power-start to output being stable (release operation) is 2 $\mu A$  greater than it is after that period (completion of release operation) because of delay circuit through current.

## ■ TEST CIRCUITS

1-1

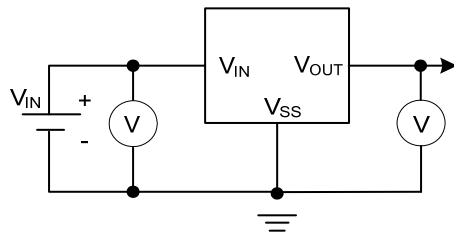

Cmos Output

1-2

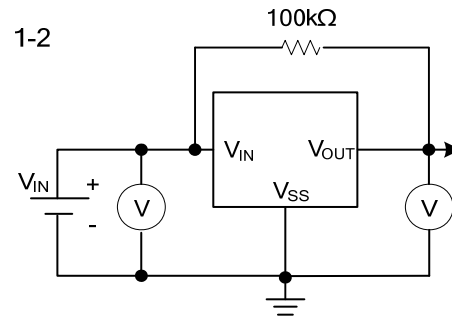

N-channel Open Drain Output

2

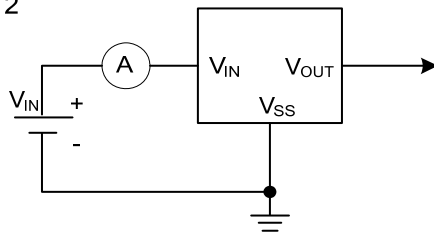

3

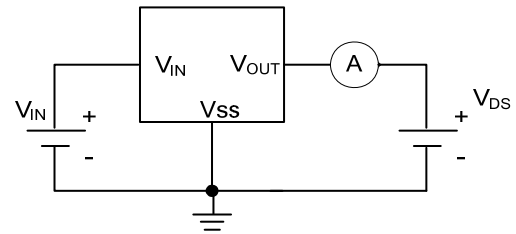

4

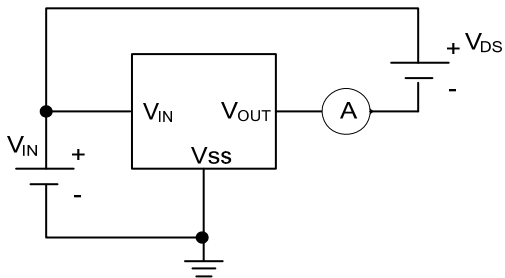

5-1

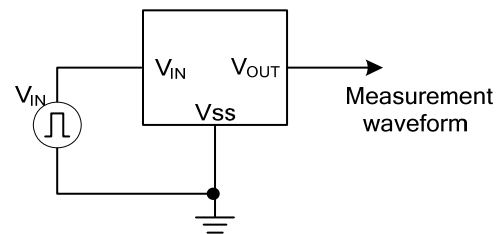

Cmos Output

5-2

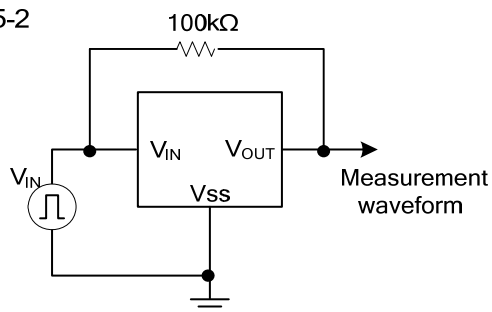

N-channel Open Drain Output



## ■ TYPICAL PERFORMANCE CHARACTERISTICS

### (1) Ambient Temperature vs. Transient Delay Time

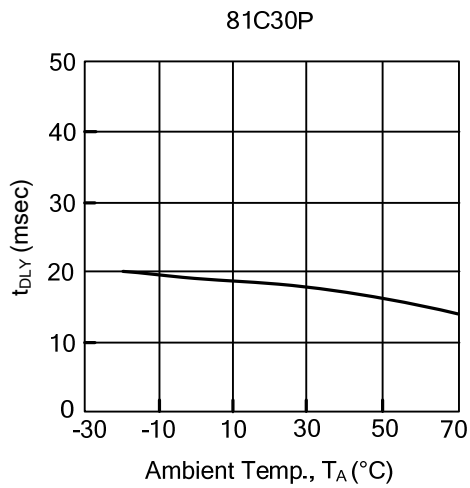
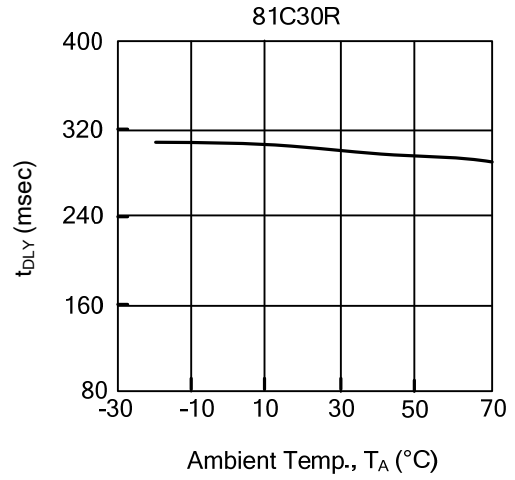
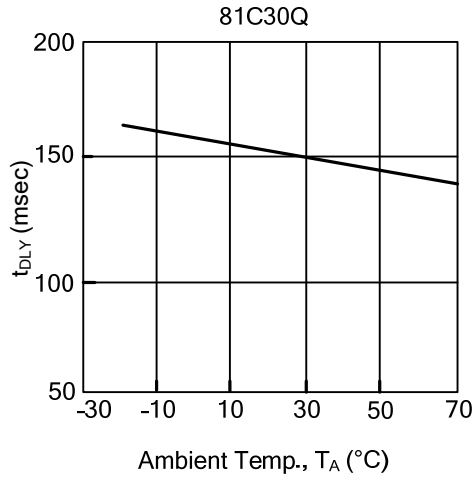

## ■ TYPICAL PERFORMANCE CHARACTERISTICS(Cont.)

### (2) P-Channel Driver Output Current vs. Input Voltage

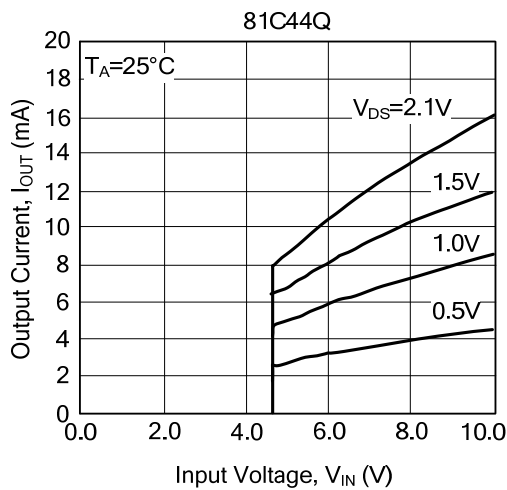
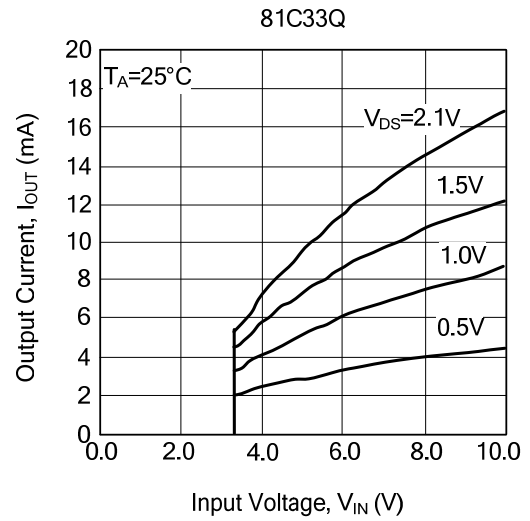
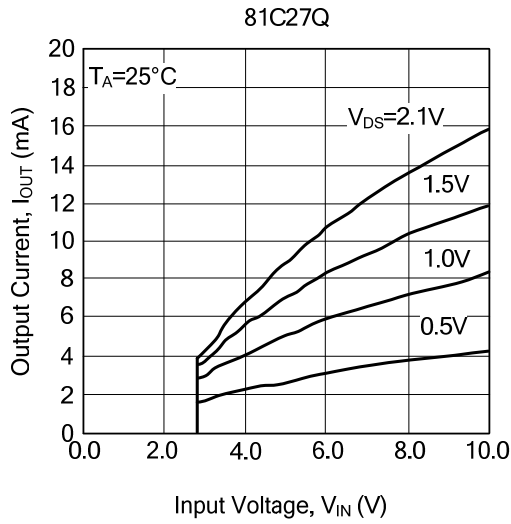

### (2) Transient Delay Time vs. Input Voltage

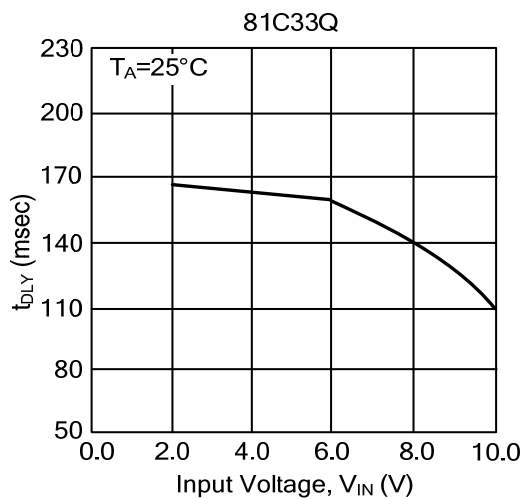

■ TYPICAL PERFORMANCE CHARACTERISTICS(Cont.)

(3) Supply Current vs. Input Voltage

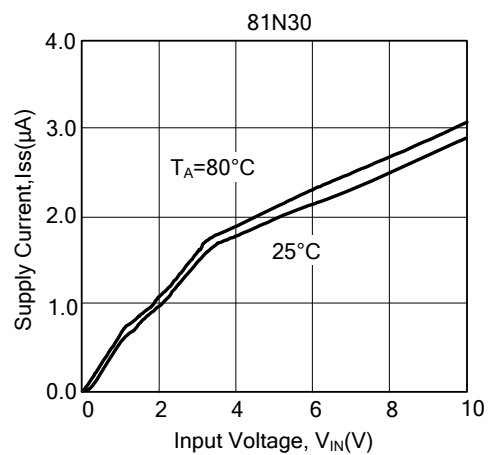
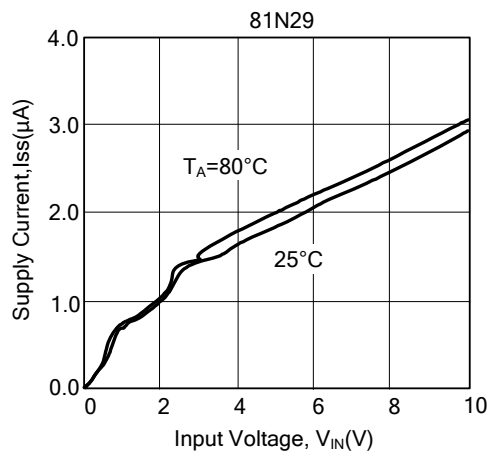
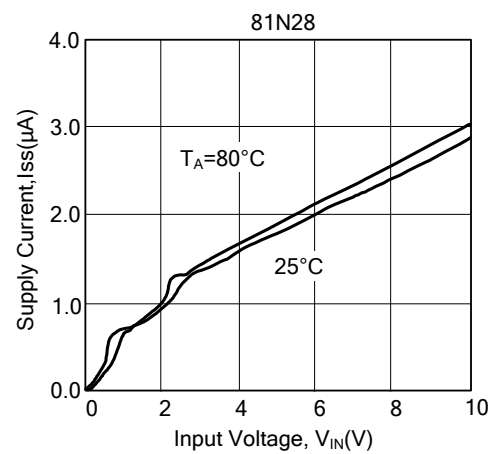
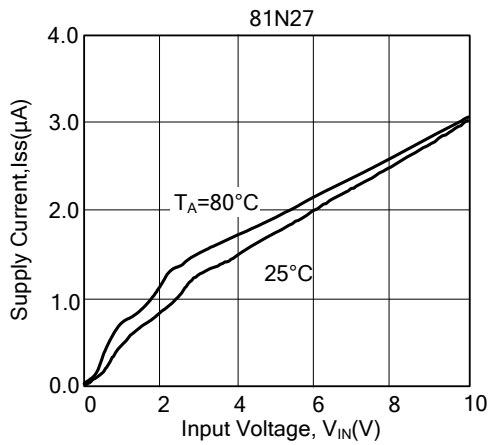
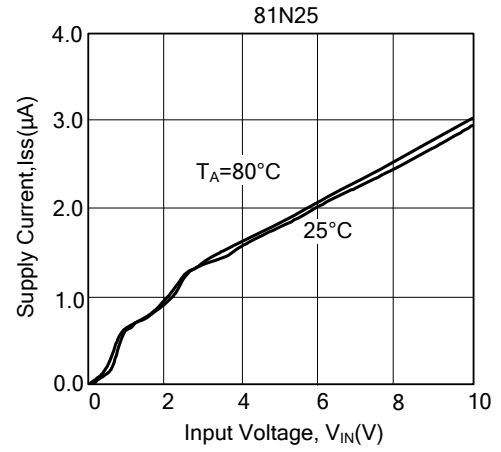
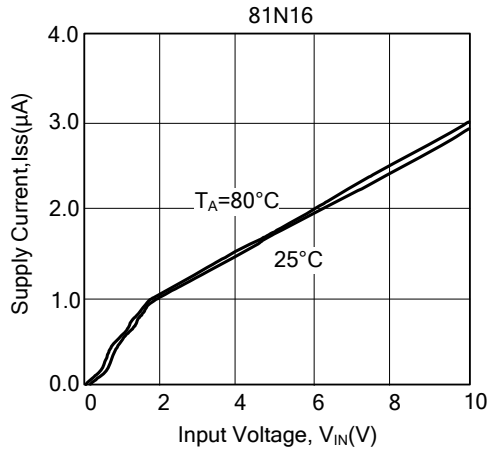

■ TYPICAL PERFORMANCE CHARACTERISTICS(Cont.)

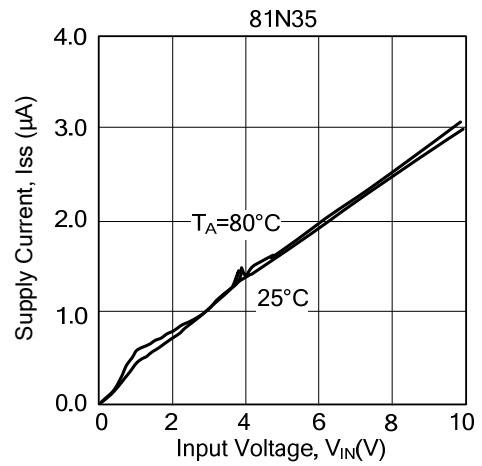
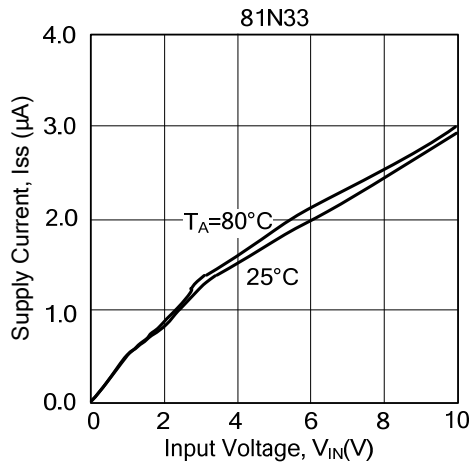

(4) Output Voltage vs. Input Voltage

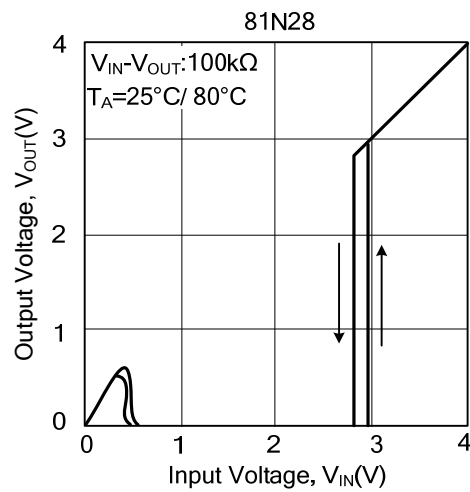
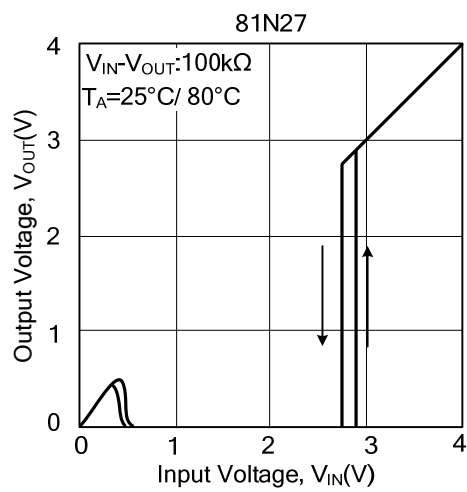
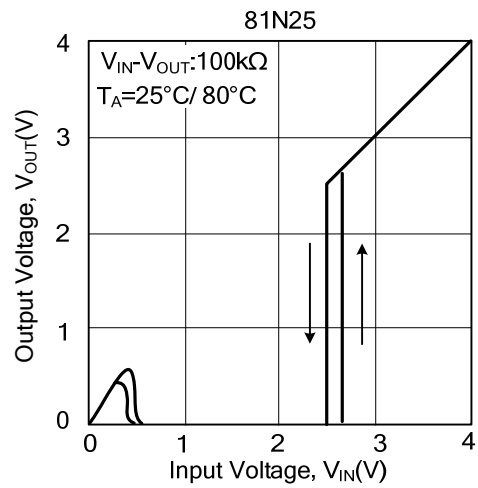
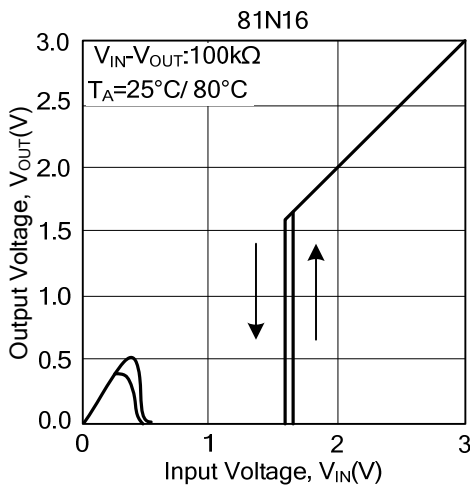

■ TYPICAL PERFORMANCE CHARACTERISTICS(Cont.)

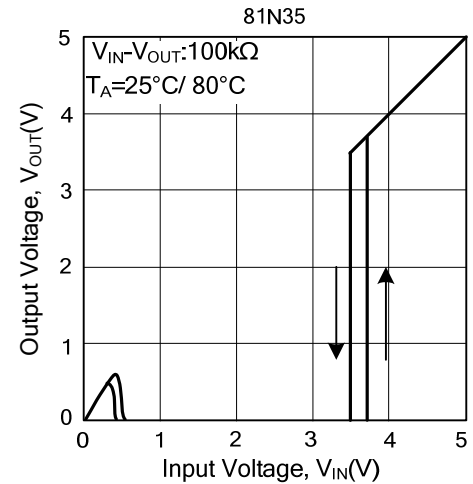
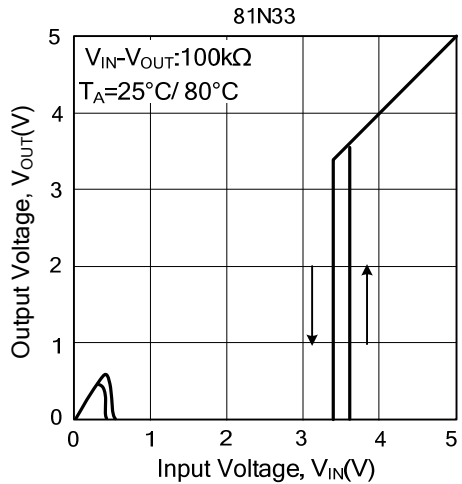
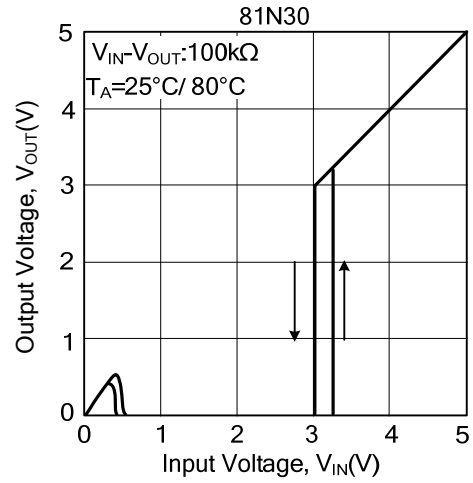
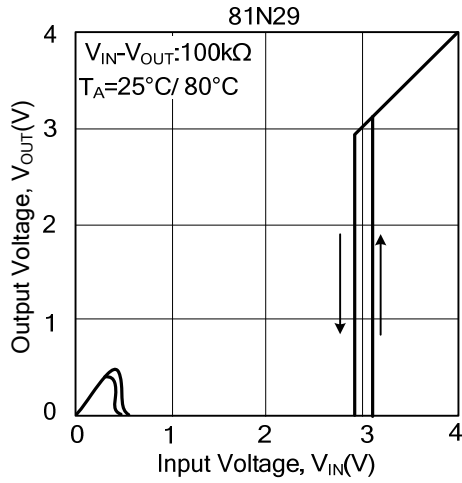

(5) N-Channel Drive Output Current vs.  $V_{DS}$

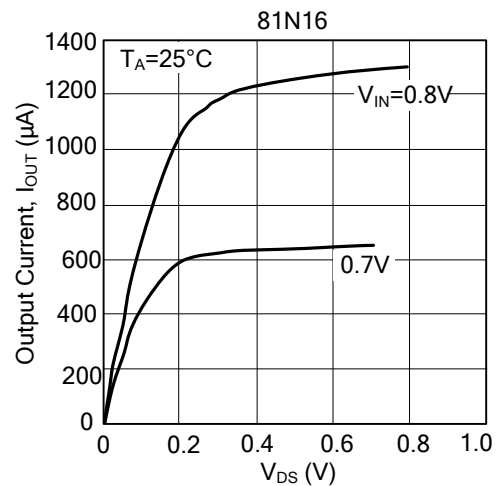
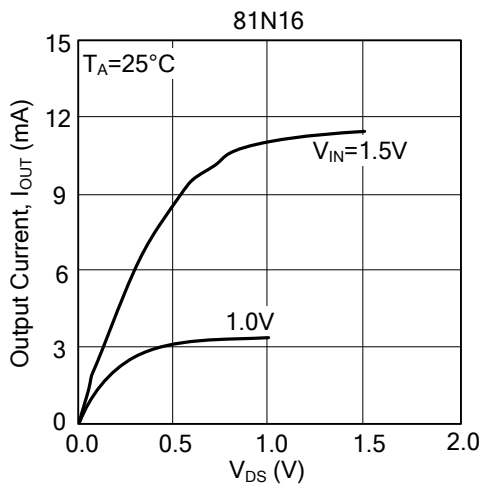

■ TYPICAL PERFORMANCE CHARACTERISTICS(Cont.)

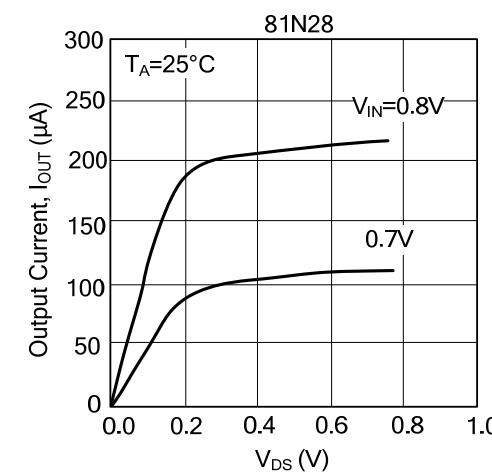
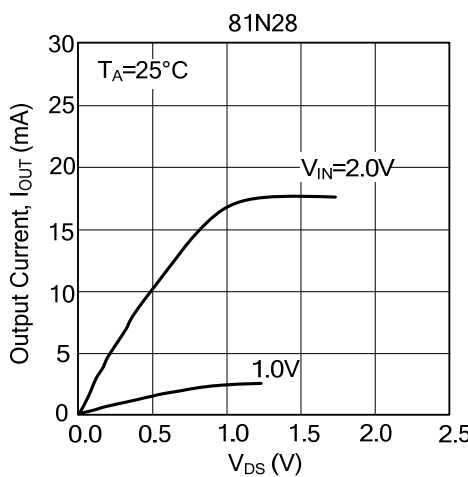
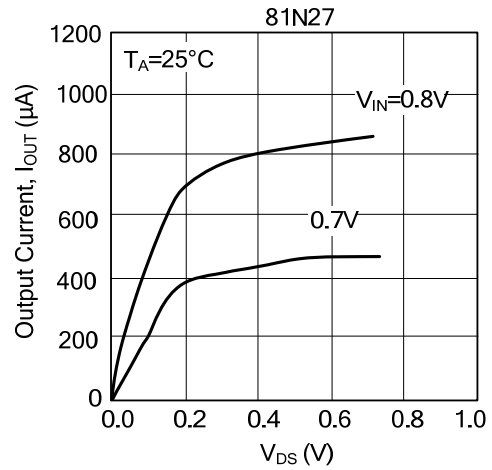
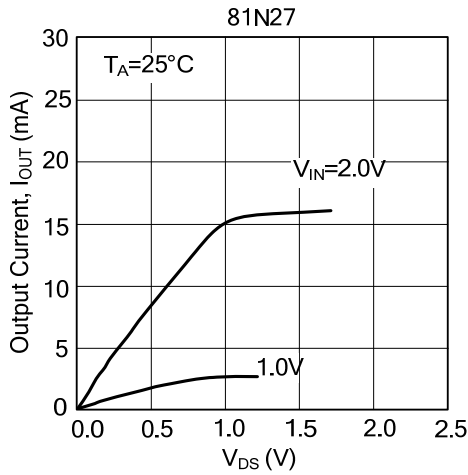
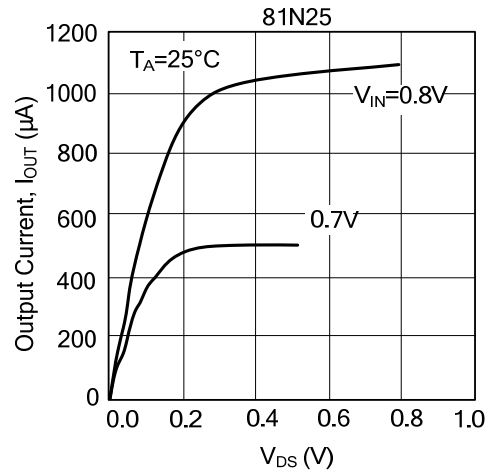
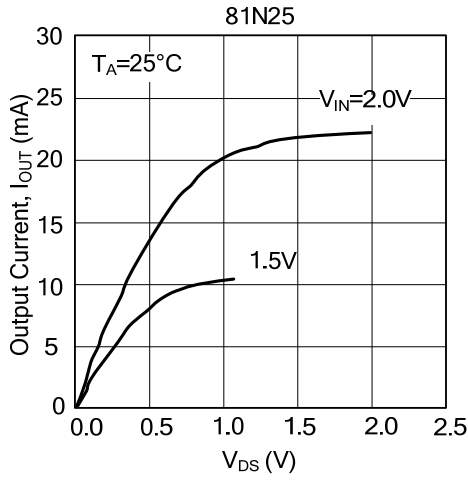

■ TYPICAL PERFORMANCE CHARACTERISTICS(Cont.)

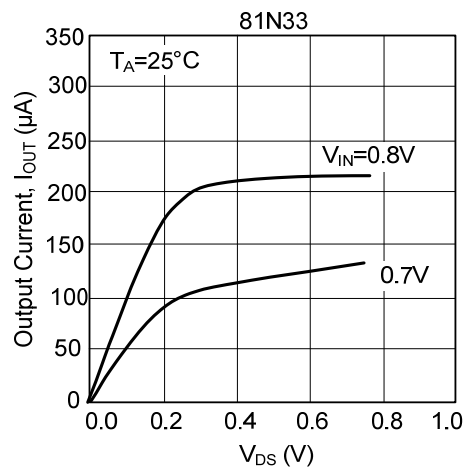
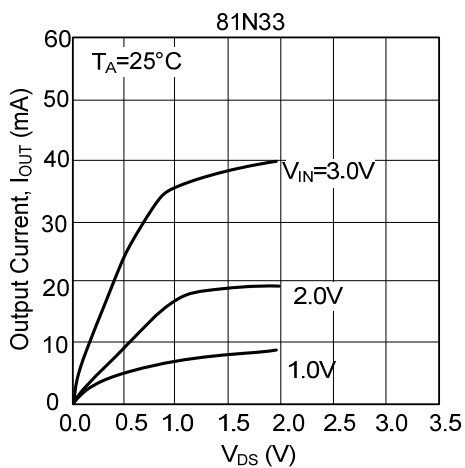
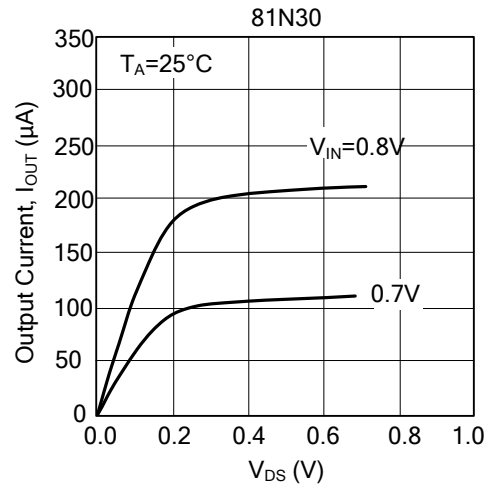
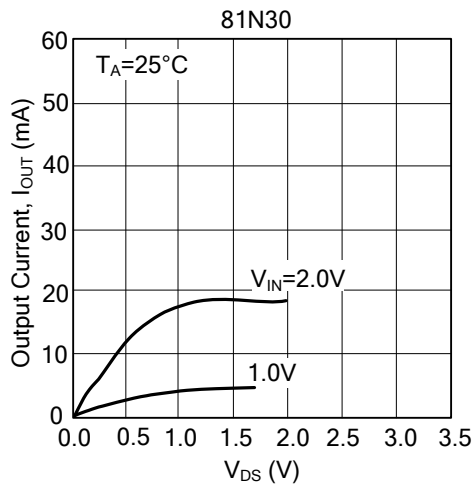
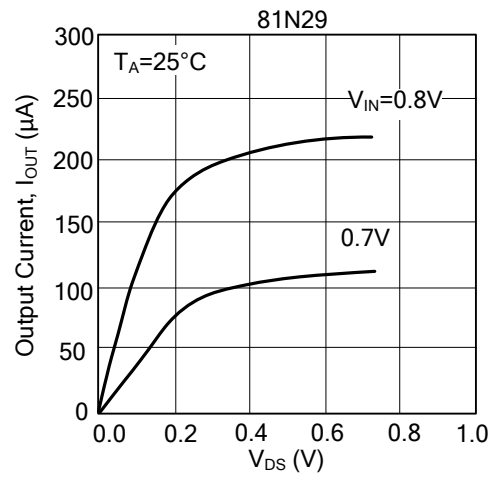
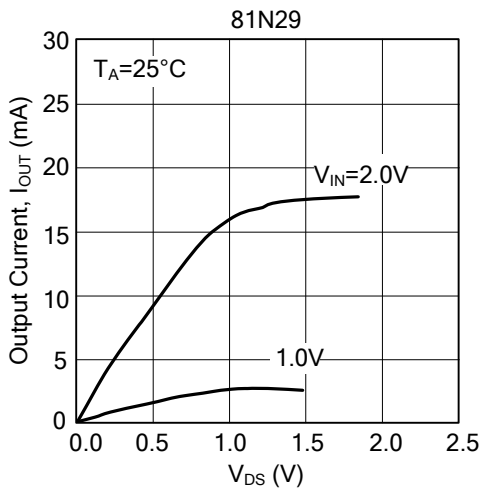

■ TYPICAL PERFORMANCE CHARACTERISTICS(Cont.)

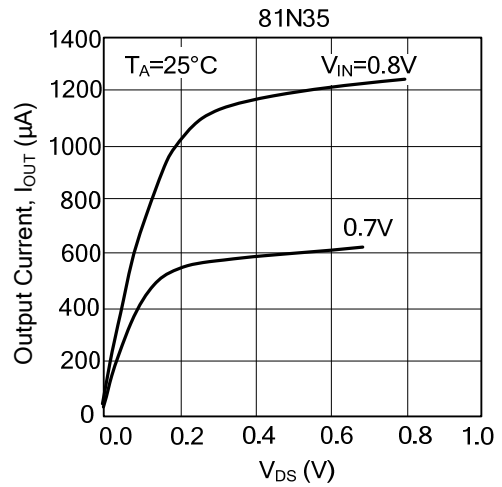
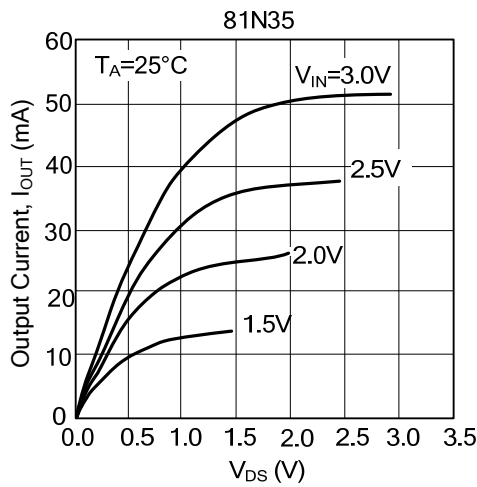

UTC assumes no responsibility for equipment failures that result from using products at values that exceed, even momentarily, rated values (such as maximum ratings, operating condition ranges, or other parameters) listed in products specifications of any and all UTC products described or contained herein. UTC products are not designed for use in life support appliances, devices or systems where malfunction of these products can be reasonably expected to result in personal injury. Reproduction in whole or in part is prohibited without the prior written consent of the copyright owner. The information presented in this document does not form part of any quotation or contract, is believed to be accurate and reliable and may be changed without notice.