

»»» Features

- Miniature 25A 250VAC Power Relay.
- UL/CUL, VDE approved.
- With and without quick connect terminals on top.
- Inductive load $\cos \phi = 0.7$, 20A 250VAC, inrush 80A 250VAC, 400ms suitable for compressor load switching and HVAC applications.

»»» Type List

Terminal style	Contact form	Designation
W (Quick terminal)	SPNO	852-W-1A-C1
P (PCB terminal)	SPNO	852-P-1A-C
WP (Quick terminal & PCB terminal)	SPNO	852-WP-1A-C

»»» Ordering Information

852 W - 1A - F - C
 1 2 3 4 5

- | | |
|------------------------------------|---------------------------|
| 1. 852 -- Basic series designation | 4. Blank -- Standard type |
| | F -- Class F |
| 2. W -- With quick terminals | |
| P -- With PCB terminals | 5. C -- Dust cover |
| WP -- With quick and PCB terminals | C1 -- Flanged cover |
| 3. 1A -- Single pole normally open | |

»»» Contact Rating

Resistive load	25A 250VAC
Inductive load ($\cos \phi = 0.7$)	20A 250VAC (Inrush 80A)

»»» Coil Rating (DC)

Rated voltage (V)	Rated current $\pm 10\%$ at 23 °C (mA)	Coil resistance $\pm 10\%$ at 23 °C (Ω)	Max. continuous voltage at 70 °C	Pick up voltage(Max) at 23 °C	Drop out voltage(Min) at 23 °C	Power consumption at rated voltage
5	180	27.8	150 % of rated voltage	75 % of rated voltage	10 % of rated voltage	approx. 0.9W
6	150	40				
9	100	90				
12	75	160				
24	38	640				
48	19	2560				

»» Specification

Contact material	AgSnO alloy	
Contact resistance ⁽¹⁾	30mΩ Max.	
Operate time ⁽¹⁾	20ms Max.	
Release time ⁽¹⁾	10ms Max.	
Insulation resistance ⁽¹⁾	100MΩ Min. (DC 500V)	
Dielectric strength ⁽¹⁾	Between open contact	: AC 1200V, 50/60Hz 1 min.
	Between contact and coil	: AC 3600V, 50/60Hz 1 min.
Vibration resistance	Operating extremes	10~50Hz , amplitude 1.0 mm
	Damage limits	10~50Hz , amplitude 2.0 mm
Shock resistance	Operating extremes	10G
	Damage limits	100G
Life expectancy	Mechanical	10,000,000 operations (frequency 18,000 operations/hr)
	Electrical	100,000 operations (frequency 1,200 operations/hr)
Operating ambient temperature	-25 ~ +70 °C (no freezing)	
Weight	Approx. 31.5g	

Note : (1) initial value

»» Safety Approval

Certified	UL / CUL	VDE
File No.	E88991	40004735

»» Safety Approval Rating

UL / CUL	VDE
25A 277VAC 1HP 125VAC 1.5HP 250VAC 30A 277VAC (NO)	25A 250VAC T85 20A 250VAC cosφ 0.7

»» Outline Dimensions

◆852-P

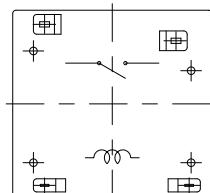
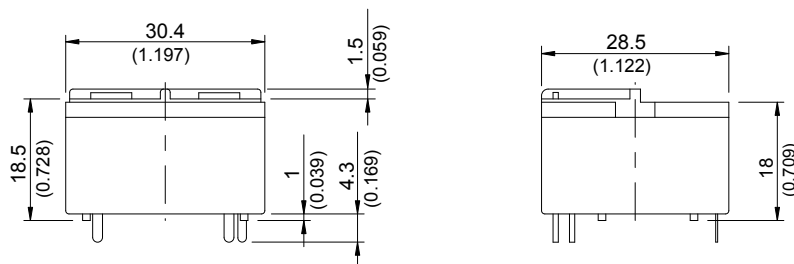

◆ 852-W

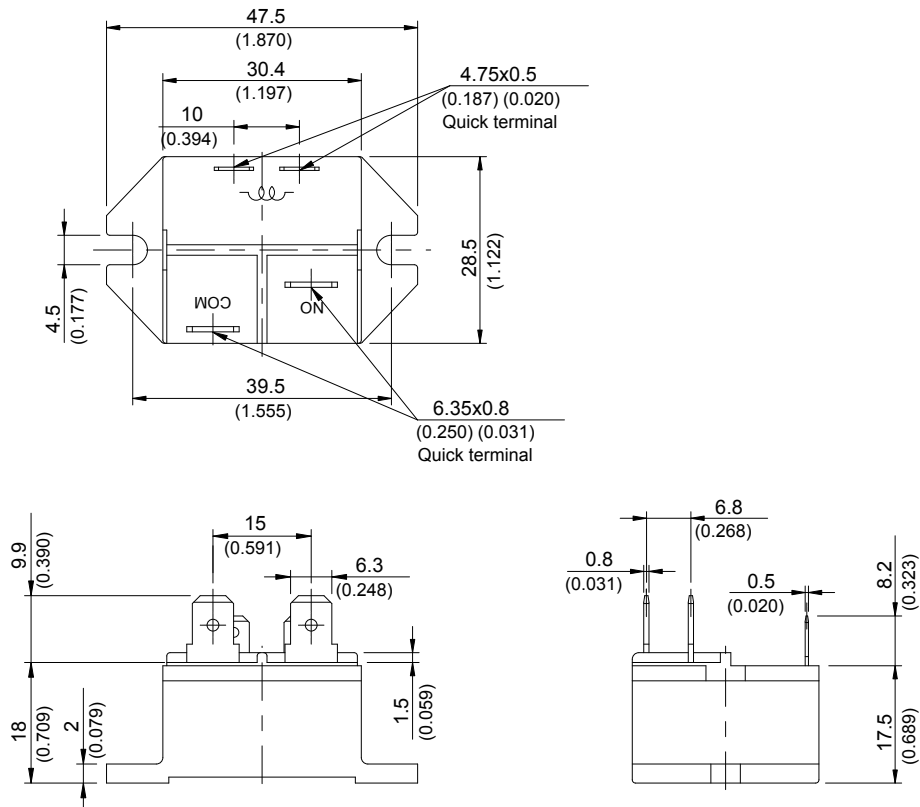

◆ 852-WP

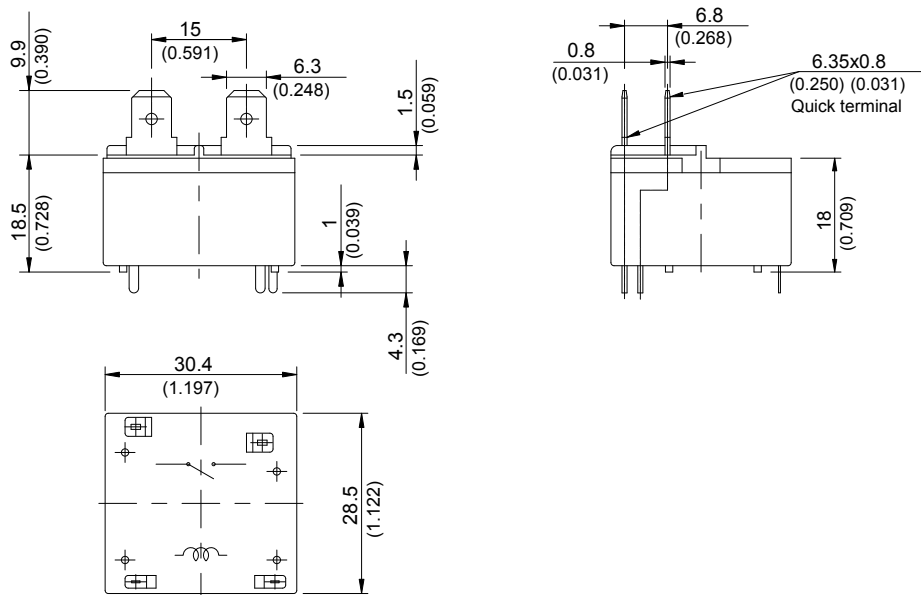

» Wiring Diagram
BOTTOM VIEW

◆ 852-W

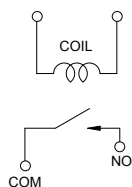

◆ 852-P/WP

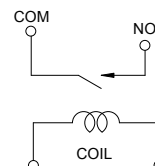

PC Board Layout BOTTOM VIEW

◆ 852-W

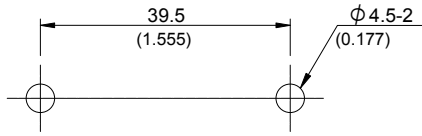

◆ 852-P/WP

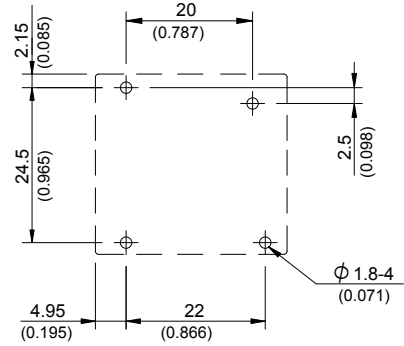

Engineering Data

