

# Preliminary Data Sheet

## Features

- For ISM band applications
- Usable bandwidth 26 MHz
- Low loss
- High attenuation
- No impedance matching required for operation at 50 Ω
- Single-ended operation
- Chip Scale Package (CSP)
- Small size

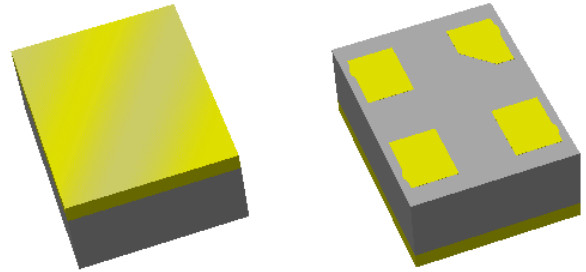

## Package

Surface Mount 2.00 x 1.50 x 0.76 mm

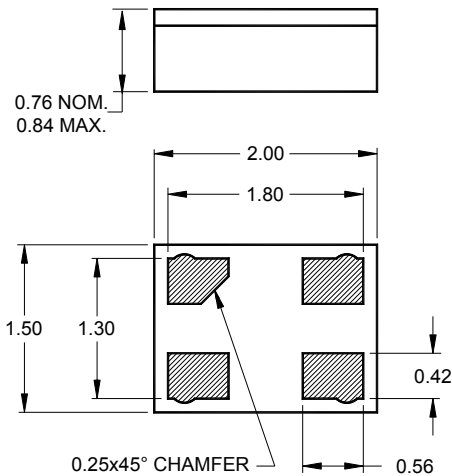

Dimensions shown are nominal in millimeters  
All tolerances are  $\pm 0.10$ mm

Body:  $Al_2O_3$  ceramic  
Lid: Kovar or Alloy 42, Au over Ni plated  
Terminations: Au plating 0.5 - 1.0  $\mu$ m,  
over a 2 - 6  $\mu$ m Ni plating

## Pin Configuration

Bottom View

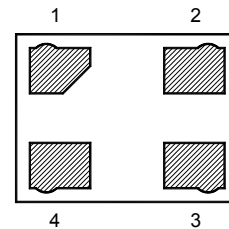

Pin No.	Description
1	Input
3	Output
2,4	Case ground

# Preliminary Data Sheet

## Electrical Specifications <sup>(1)</sup>

Operating Temperature Range: <sup>(2)</sup> -30 to +85 °C

Parameter <sup>(3)</sup>	Minimum	Typical <sup>(4)</sup>	Maximum	Unit
<b>Center Frequency</b>	-	915	-	MHz
<b>Maximum Insertion Loss</b> 902 - 928 MHz	-	2.3	3.0	dB
<b>Absolute Attenuation</b>				
10 - 857.5 MHz	40	47	-	dB
857.5 - 882.5 MHz	35	43	-	dB
970 - 1005 MHz	35	40	-	dB
1005 - 1110 MHz	40	50	-	dB
1110 - 3000 MHz	30	30	-	dB
<b>Amplitude Ripple</b> 902 - 928 MHz	-	0.35	1	dB p-p
<b>Group Delay Variation</b> 902 - 928 MHz	-	15	50	nS p-p
<b>Input/Output Return Loss</b> 902 - 928 MHz	10	14	-	dB
<b>Source Impedance <sup>(5)</sup></b>	-	50	-	Ω
<b>Load Impedance <sup>(5)</sup></b>	-	50	-	Ω

### Notes:

1. All specifications are based on the test circuit shown below
2. In production, devices will be tested at room temperature to a guardbanded specification to ensure electrical compliance over temperature
3. Electrical margin has been built into the design to account for the variations due to temperature drift and manufacturing tolerances
4. Typical values are given at 25 °C
5. This is the optimum impedance in order to achieve the performance shown

### Test Circuit:

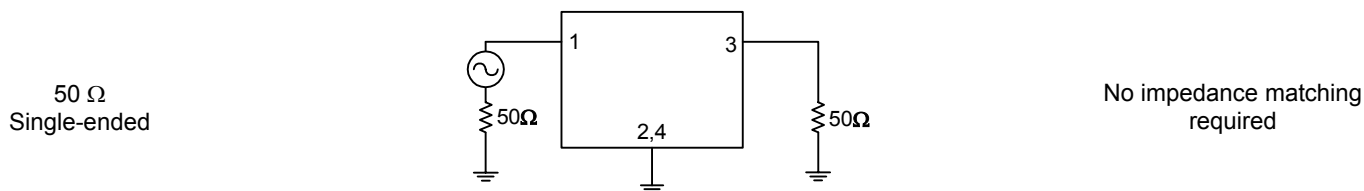

**Preliminary Data Sheet**

**Typical Performance (at +25°C)**

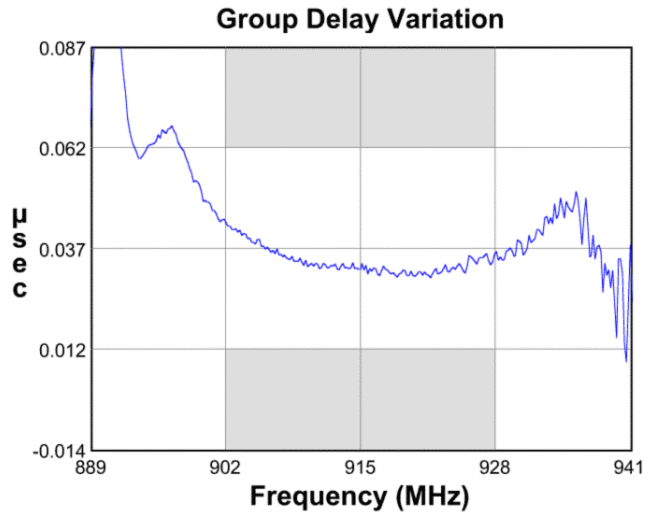
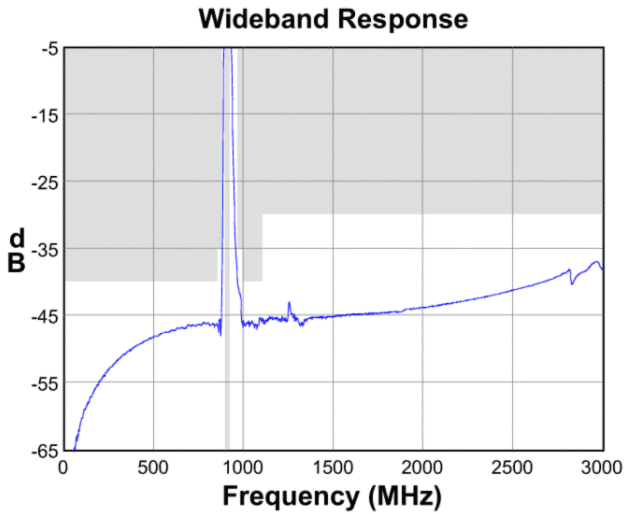
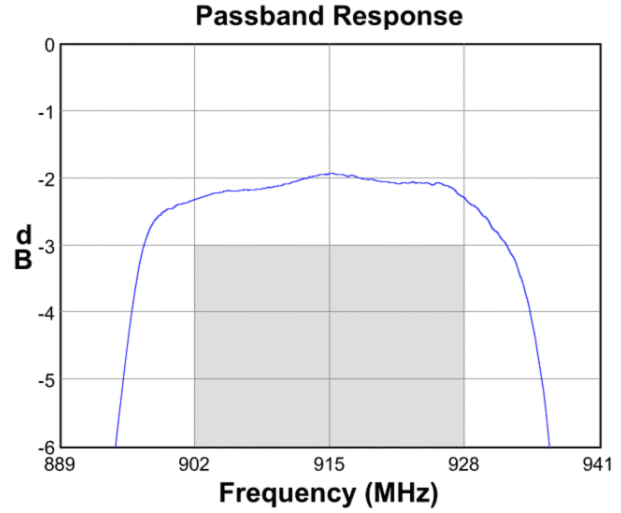
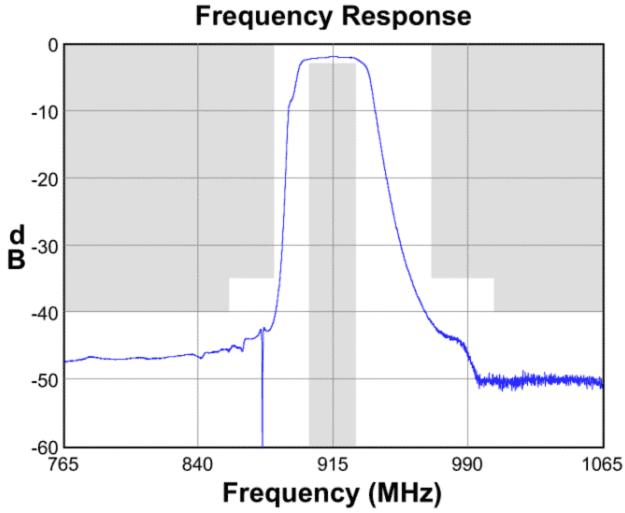

**Input Smith Chart**

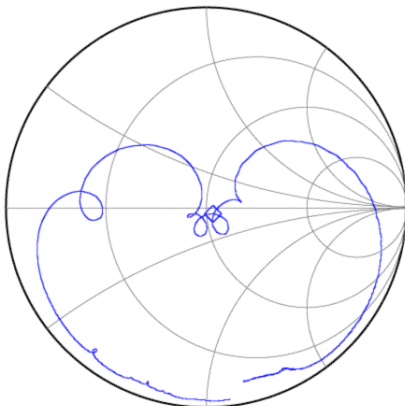

**Output Smith Chart**

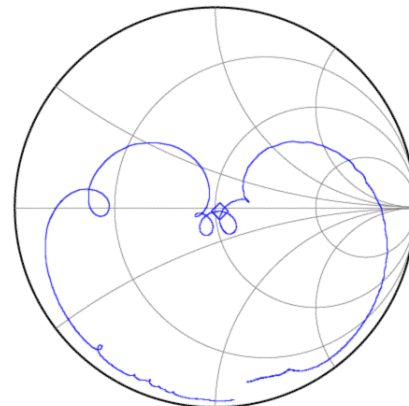

**Preliminary Data Sheet**

**Matching Schematics**

50 Ω  
Single-ended

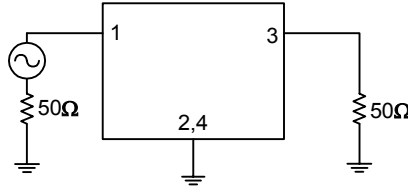

No impedance matching required

**Marking PCB Footprint**

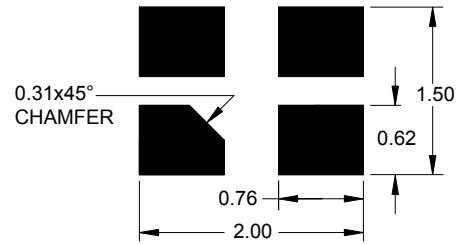
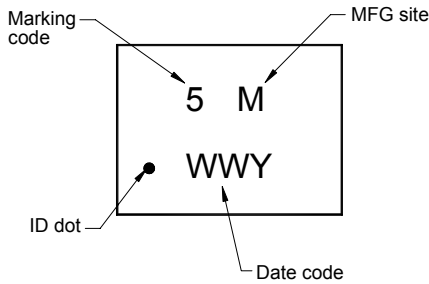

This footprint represents a recommendation only  
Dimensions shown are nominal in millimeters

**Tape and Reel**

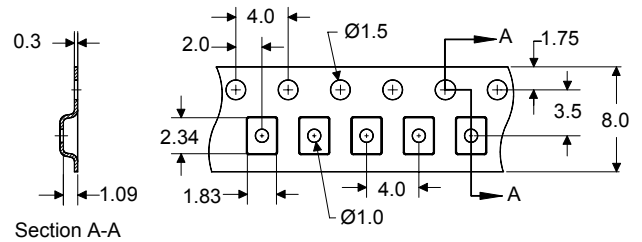
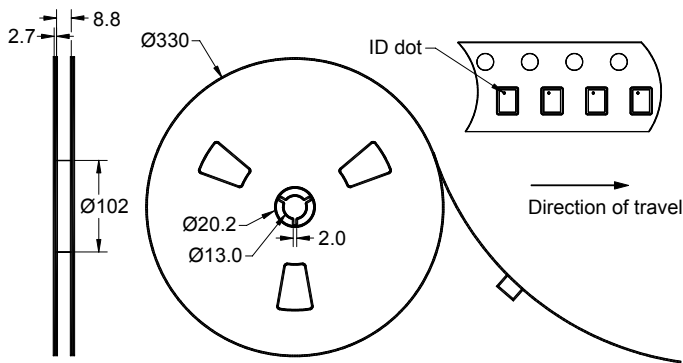

Dimensions shown are nominal in millimeters  
Packaging quantity: 10000 units/reel

# Preliminary Data Sheet

## Maximum Ratings

Parameter	Symbol	Minimum	Maximum	Unit
Operating Temperature Range	T	-30	+85	°C
Storage Temperature Range	T <sub>stg</sub>	-40	+85	°C

### Warnings

- Electrostatic Sensitive Device (ESD) 
- Avoid ultrasonic exposure

## Links to Additional Technical Information

[PCB Layout Tips](#)

[Qualification Flowchart](#)

[Soldering Profile](#)

[S-Parameters](#)

[Other Technical Information](#)

Sawtek's liability is limited only to the Surface Acoustic Wave (SAW) component(s) described in this data sheet. Sawtek does not accept any liability for applications, processes, circuits or assemblies which are implemented using any Sawtek component described in this data sheet.

## Contact Information



PO Box 609501  
Orlando, FL 32860-9501  
USA

Phone: +1 (407) 886-8860  
Fax: +1 (407) 886-7061  
Email: [custservice@sawtek.com](mailto:custservice@sawtek.com)  
Web: [www.sawtek.com](http://www.sawtek.com)

Or contact one of our worldwide  
Network of [sales offices](#),  
[Representatives or distributors](#)