

## Fast Recovery Diodes (Stud Version), 85A



### FEATURES

- Short reverse recovery time
- Low stored charge
- Wide current range
- Excellent surge capabilities
- Stud cathode and stud anode versions
- Voltage up to 1200 V<sub>RRM</sub>
- Compliant to RoHS directive 2002/95/EC



DO-203AB(DO-5)

### TYPICAL APPLICATIONS

- DC power supplies
- Inverters
- Converters
- Choppers
- Ultrasonic systems
- Freewheeling diodes

### PRODUCT SUMMARY

I <sub>F(AV)</sub>	85A
--------------------	-----

### MAJOR RATINGS AND CHARACTERISTICS

SYMBOL	CHARACTERISTICS	85FD(R)	UNIT
I <sub>F(AV)</sub>		85	A
	Maximum T <sub>C</sub>	85	°C
I <sub>FSM</sub>	50 HZ	1308	A
	60 HZ	1369	
I <sup>2</sup> t	50 HZ	8554	A <sup>2</sup> s
	60 HZ	7778	
I <sup>2</sup> √t		85543	I <sup>2</sup> √s
V <sub>RRM</sub>	Range	200 to 1200	V
t <sub>rr</sub>		See Recovery Characteristics table	ns
T <sub>J</sub>	Range	-40 to 125	°C

### ELECTRICAL SPECIFICATIONS

#### VOLTAGE RATINGS

TYPE NUMBER	VOLTAGE CODE	V <sub>RRM</sub> , MAXIMUM PEAK REPETITIVE REVERSE VOLTAGE T <sub>J</sub> = -40°C TO 125°C V	V <sub>RSM</sub> , MAXIMUM PEAK NON-REPETITIVE REVERSE VOLTAGE T <sub>J</sub> = 25°C TO 125°C V	I <sub>FM</sub> , MAXIMUM PEAK REVERSE CURRENT AT RATED V <sub>RRM</sub> mA	
				T <sub>J</sub> = 25°C	T <sub>J</sub> = 125°C
85FD(R)	02	200	300	0.1	20
	04	400	500		
	06	600	700		
	08	800	900		
	10	1000	1100		
	12	1200	1300		

FORWARD CONDUCTION					
PARAMETER	SYMBOL	TEST CONDITIONS		85FD(R)	UNIT
Maximum average forward current at maximum case temperature	$I_{F(AV)}$	180° conduction, half sine wave		85	A
				85	°C
Maximum RMS forward current	$I_{F(RMS)}$			133	A
Maximum peak repetitive forward current	$I_{FRM}$	Sinusoidal half wave, 30° conduction		470	A
Maximum peak, one-cycle non-repetitive surge current	$I_{FSM}$	t = 10ms	Sinusoidal half wave, 100% $V_{RRM}$ reapplied, initial $T_J = T_J$ maximum	1100	A
		t = 8.3ms		1151	
		t = 10ms	Sinusoidal half wave, no voltage reapplied, initial $T_J = T_J$ maximum	1308	
		t = 8.3ms		1369	
Maximum $I^2t$ for fusing	$I^2t$	t = 10ms	100% $V_{RRM}$ reapplied, initial $T_J = T_J$ maximum	6050	A <sup>2</sup> s
		t = 8.3ms		5498	
		t = 10ms	no voltage reapplied, initial $T_J = T_J$ maximum	8554	
		t = 8.3ms		7778	
Maximum $I^2\sqrt{t}$ for fusing <sup>(1)</sup>	$I^2\sqrt{t}$	t = 0.1 ms to 10 ms, no voltage reapplied		85543	A <sup>2</sup> √s
Maximum value of threshold voltage	$V_{F(TO)}$	$T_J = 125^\circ\text{C}$		1.128	V
Maximum value of forward slope resistance	$r_F$			2.11	mΩ
Maximum forward voltage drop	$V_{FM}$	$T_J = 25^\circ\text{C}; I_{FM} = 265\text{A}$		1.75	V

Note : <sup>(1)</sup>  $I^2t$  for time  $t_x = I^2\sqrt{t} \sqrt{t_x}$

SWITCHING					
PARAMETER	SYMBOL	TEST CONDITIONS	85FD(R)		UNIT
			02 to 06	08 to 12	
Typical reverse recovery time	$t_{rr}$	$T_J = 25^\circ\text{C}, I_F = 0.5\text{A}, I_R = 1.0\text{A}, I_{RR} = 250\text{mA (RG\#1 CKT)}$	200	500	ns
		$T_J = 25^\circ\text{C}, I_F = 1\text{A to } V_R = 30\text{V}, -di_F/dt = 100\text{ A}/\mu\text{s}$	50	120	
		$T_J = 25^\circ\text{C}, -di_F/dt = 25\text{ A}/\mu\text{s}, I_{FM} = \pi \times \text{rated } I_{F(AV)}$	200	500	
Typical reverse recovered charge	$Q_{rr}$	$T_J = 25^\circ\text{C}, I_F = 1\text{A to } V_R = 30\text{V}, -di_F/dt = 100\text{ A}/\mu\text{s}$	70	340	nC
		$T_J = 25^\circ\text{C}, -di_F/dt = 25\text{ A}/\mu\text{s}, I_{FM} = \pi \times \text{rated } I_{F(AV)}$	240	1300	

THERMAL AND MECHANICAL SPECIFICATIONS				
PARAMETER	SYMBOL	TEST CONDITIONS	85FD(R)	UNITS
Maximum junction operating temperature range	$T_J$		-40 to 125	°C
Maximum storage temperature range	$T_{stg}$		-40 to 150	
Maximum thermal resistance, junction to case	$R_{thJC}$	DC operation	0.30	K/W
Maximum thermal resistance, case to heatsink	$R_{thCS}$	Mounting surface, smooth, flat and greased	0.25	
Maximum allowable mounting torque (+0%, -10%)		Not lubricated threads, tightening on nut <sup>(1)</sup>	3.4(30)	N · m (lbf · in)
		Lubricated thread, tightening on nut <sup>(1)</sup>	2.3(20)	
		Not lubricated threads, tightening on hexagon <sup>(2)</sup>	4.2(37)	
		Lubricated thread, tightening on hexagon <sup>(2)</sup>	3.2(28)	
Approximate weight			25	g
			0.88	oz.
Case style		JEDEC	DO-203AB (DO-5)	

**Note :** (1) Recommended for pass-through holes  
 (2) Recommended for holed threaded heatsinks

$\Delta R_{thJC}$ CONDUCTION				
CONDUCTION ANGEL	85FD(R)		TEST CONDUCTIONS	UNITS
	SINUSOIDAL CONDUCTION	RECTANGULAR CONDUCTION		
180°	0.37	0.21	$T_J = 150^\circ\text{C}$	K/W
120°	0.39	0.37		
60°	0.82	0.82		
30°	1.41	1.41		

**Note**  
 • The table above shows the increment of thermal resistance  $R_{thJC}$  when devices operate at different conduction angles than DC

ORDERING INFORMATION SCHEME	
	<b>85 FD R 06 A</b>
<b>Current</b>	85 = 85A
<b>Diode type</b>	FD = Fast Recovery Diode
<b>Polarity</b>	R = Reverse, Anode on Stud None = standard, Cathode on Stud
<b>Voltage</b>	06 = 600V 08 = 800V 10 = 1000V 12 = 1200V
<b>Trr value</b>	A = 200 ns Max. B = 500 ns Max.

**Fig.1 Current rating nomogram (Sinusoidal Waveforms)**

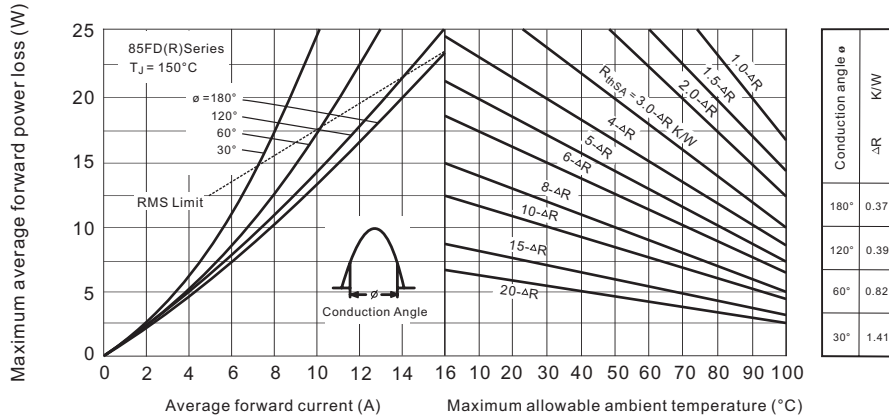

**Fig.2 Current rating nomogram (Rectangular waveforms)**

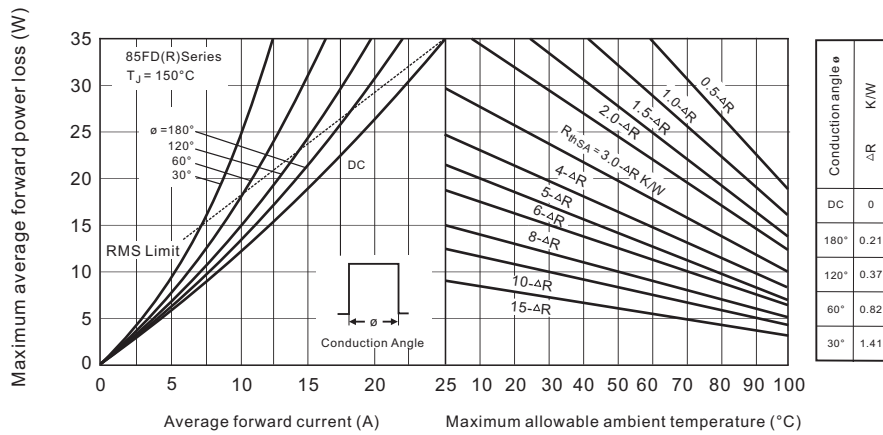

**Fig.3 Maximum high level forward power loss vs. average forward current**

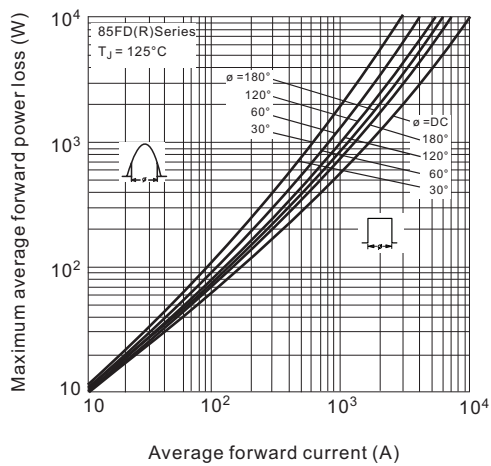

**Fig.4 Maximum forward voltage vs. forward current.**

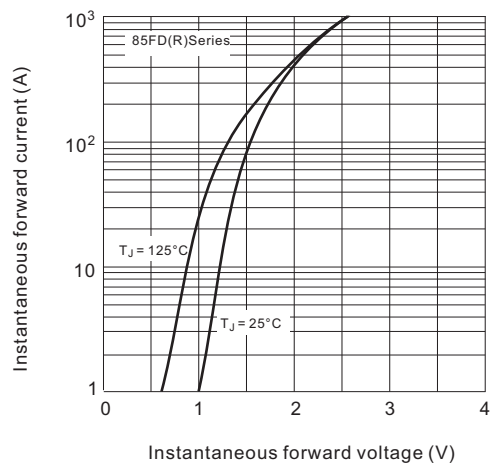

**Fig.5 Average forward current vs. maximum allowable case temperature.**

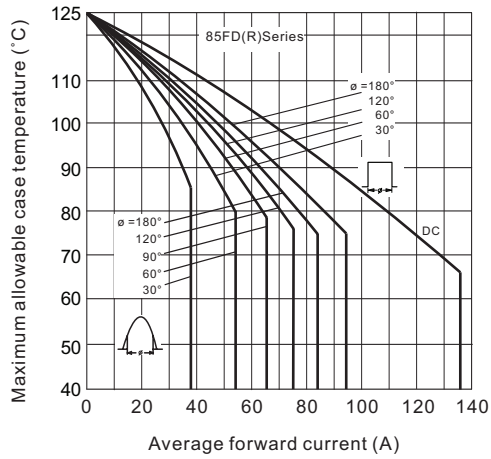

**Fig.6 Typical reverse recovery time vs. rate of fall of forward current.**

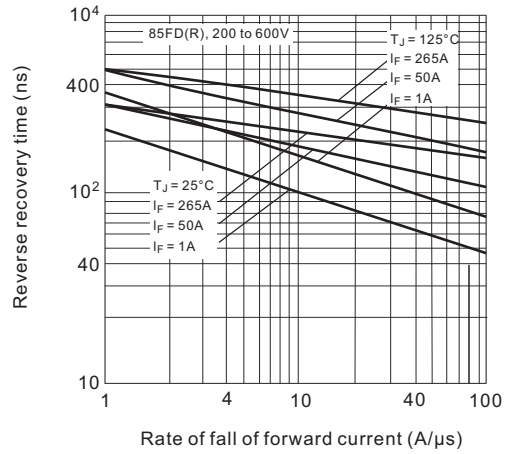

**Fig.7 Typical recovered charge vs. rate of fall of forward current.**

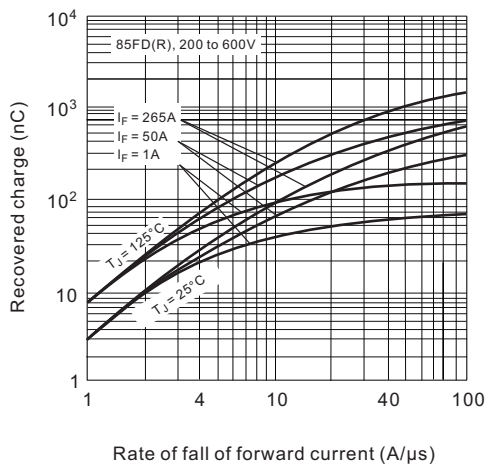

**Fig.8 Typical reverse recovery time vs. rate of fall of forward current.**

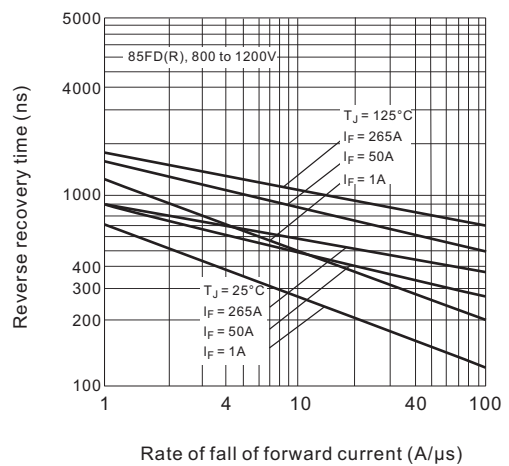

**Fig.9 Typical recovered charge vs. rate of fall of forward current.**

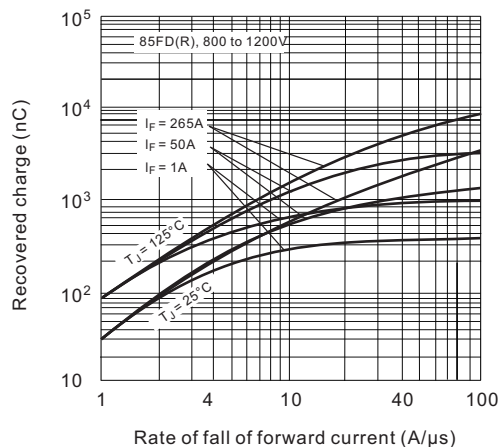

**DO-203AB(DO-5)**

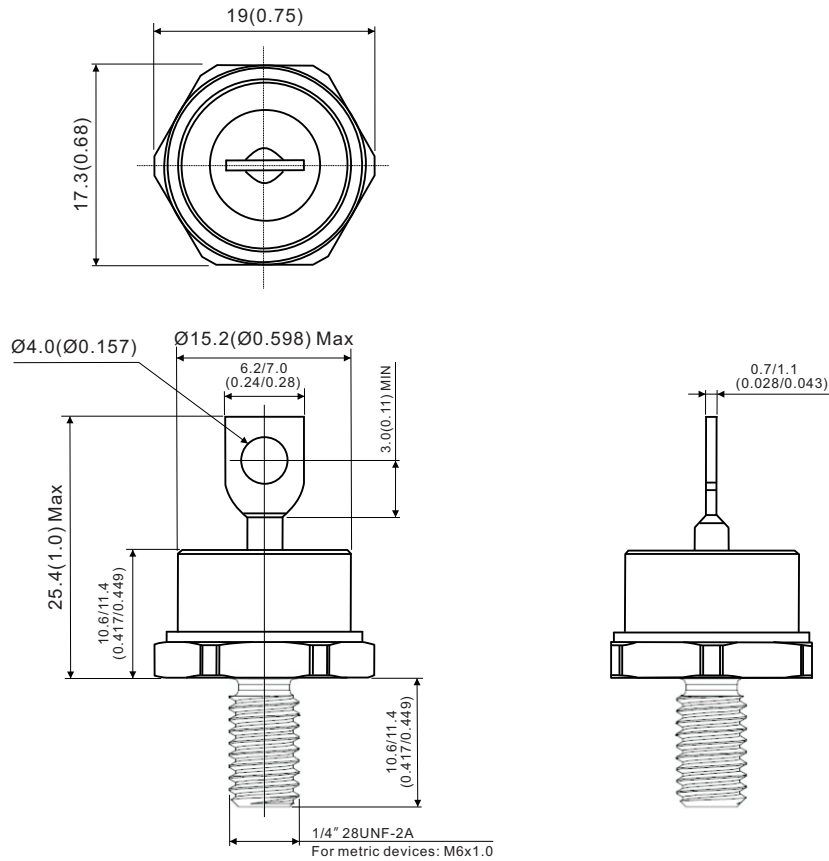

All dimensions in millimeters (inches)

