

Device Overview

The 89HPES8NT2 is a member of the IDT PRECISE™ family of PCI Express® switching solutions offering the next-generation I/O interconnect standard. The PES8NT2 is a 8-lane, 2-port peripheral chip that provides high-performance switching and non-transparent bridging (NTB) functions between a PCIe® upstream port and an NTB downstream port. The PES8NT2 is a part of the IDT PCIe System Interconnect Products and is intended to be used with IDT PCIe System Interconnect Switches. Together, the chipset targets multi-host and intelligent I/O applications such as communications, storage, and blade servers where inter-domain communication is required.

Features

- ◆ **High Performance PCI Express Switch**
 - Eight PCI Express lanes (2.5Gbps), two switch ports
 - Delivers 32 Gbps (4 GBps) of aggregate switching capacity
 - Low latency cut-through switch architecture
 - Support for Max Payload size up to 2048 bytes
 - Supports one virtual channel and eight traffic classes
 - PCI Express Base specification Revision 1.0a compliant
- ◆ **Flexible Architecture with Numerous Configuration Options**
 - Supports automatic per port link width negotiation (x8, x4, x2, or x1)
 - Static lane reversal on all ports
 - Automatic polarity inversion on all lanes

- Supports locked transactions, allowing use with legacy software
- Ability to load device configuration from serial EEPROM
- Ability to control device via SMBus
- ◆ **Non-Transparent Port**
 - Crosslink support on NTB port
 - Four mapping windows supported
 - Each may be configured as a 32-bit memory or I/O window
 - May be paired to form a 64-bit memory window
 - Interprocessor communication
 - Thirty-two inbound and outbound doorbells
 - Four inbound and outbound message registers
 - Two shared scratchpad registers
 - Allows up to sixteen masters to communicate through the non-transparent port
 - No limit on the number of supported outstanding transactions through the non-transparent bridge
 - Completely symmetric non-transparent bridge operation allows similar/same configuration software to be run
 - Supports direct connection to a transparent or non-transparent port of another switch
- ◆ **Highly Integrated Solution**
 - Requires no external components
 - Incorporates on-chip internal memory for packet buffering and queueing
 - Integrates eight 2.5 Gbps embedded full duplex SerDes, 8B/10B encoder/decoder (no separate transceivers needed)

Block Diagram

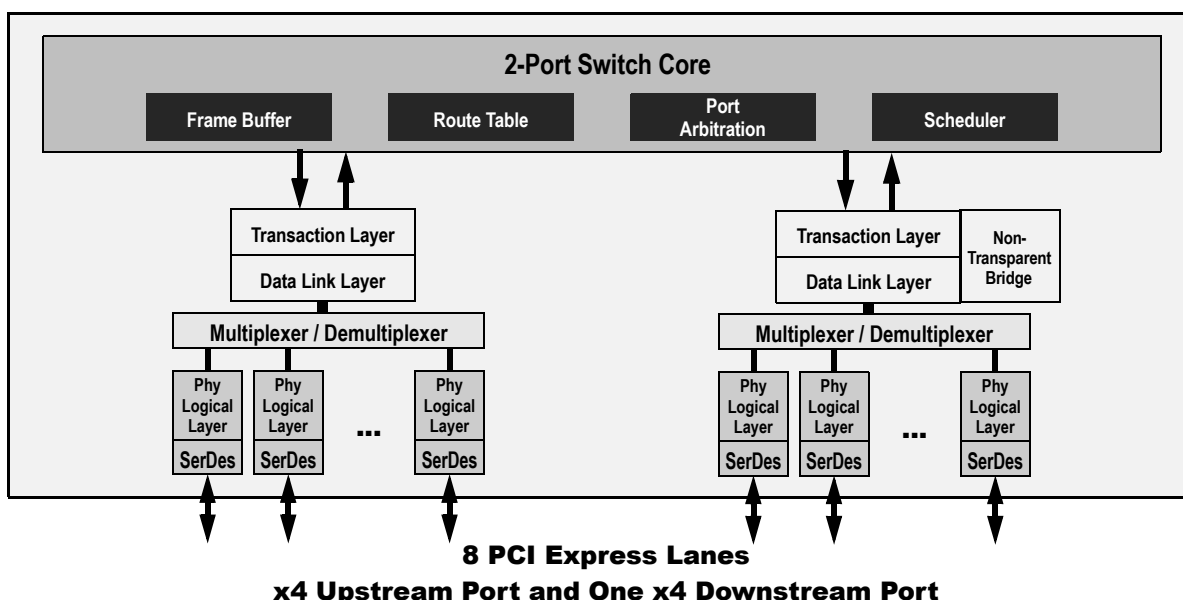

Figure 1 Internal Block Diagram

IDT and the IDT logo are registered trademarks of Integrated Device Technology, Inc.

- ◆ **Reliability, Availability, and Serviceability (RAS) Features**
 - Internal end-to-end parity protection on all TLPs ensures data integrity even in systems that do not implement end-to-end CRC (ECRC)
 - Supports ECRC pass-through
 - Supports Hot-Swap
- ◆ **Power Management**
 - Supports PCI Power Management Interface specification, Revision 1.1 (PCI-PM)
 - Unused SerDes are disabled
- ◆ **Testability and Debug Features**
 - Built in SerDes Pseudo-Random Bit Stream (PRBS) generator
 - Ability to read and write any internal register via the SMBus
 - Ability to bypass link training and force any link into any mode
 - Provides statistics and performance counters
- ◆ **Two SMBus Interfaces**
 - Slave interface provides full access to all software-visible registers by an external SMBus master
 - Master interface provides connection for an optional serial EEPROM used for initialization
 - Master and slave interfaces may be tied together so the switch can act as both master and slave
- ◆ **Eight General Purpose Input/Output pins**
- ◆ **Packaged in 19x19mm 324 ball BGA with 1mm ball spacing**

Product Description

Utilizing standard PCI Express interconnect, the PES8NT2 provides the most efficient high-performance I/O connectivity solution for applications requiring high throughput, low latency, and simple board layout with a minimum number of board layers. With support for non-transparent bridging, the PES8NT2 is part of the IDT PCIe System Interconnect Products that target multi-host and intelligent I/O applications requiring inter-domain communication. The PES8NT2 provides 32 Gbps (4 GBps) of aggregated, full-duplex switching capacity through 8 integrated serial lanes, using proven and robust IDT technology. Each lane provides 2.5 Gbps of bandwidth in both directions and is fully compliant with PCI Express Base specification 1.0a.

The PES8NT2 is based on a flexible and efficient layered architecture. The PCI Express layer consists of SerDes, Physical, Data Link, and Transaction layers in compliance with PCI Express Base specification Revision 1.0a. The PES8NT2 can operate either as a store and forward or cut-through switch depending on the packet size and is designed to switch memory and I/O transactions. It supports eight Traffic Classes (TCs) and one Virtual Channel (VC) with sophisticated resource management.

Switch Configuration

The PES8NT2 is a two port switch that contains eight PCI Express lanes. Each of the two ports is statically allocated eight lanes with ports labeled as A and C. Port A is the upstream port and port C is the non-transparent downstream port.

During link training, link width is automatically negotiated. Each PES8NT2 port is capable of independently negotiating to a x4, x2, or x1 width. Thus, the PES8NT2 may be used in virtually any two port switch configuration (e.g., {x4, x4}, {x4, x2}, {x2, x2}, etc.). The PES8NT2 supports static lane reversal. For example, lane reversal for upstream port A may be configured by asserting the PCI Express Port A Lane Reverse (PEALREV) input signal or through serial EEPROM or SMBus initialization. Lane reversal for port C may be enabled via a configuration space register, serial EEPROM, or the SMBus.

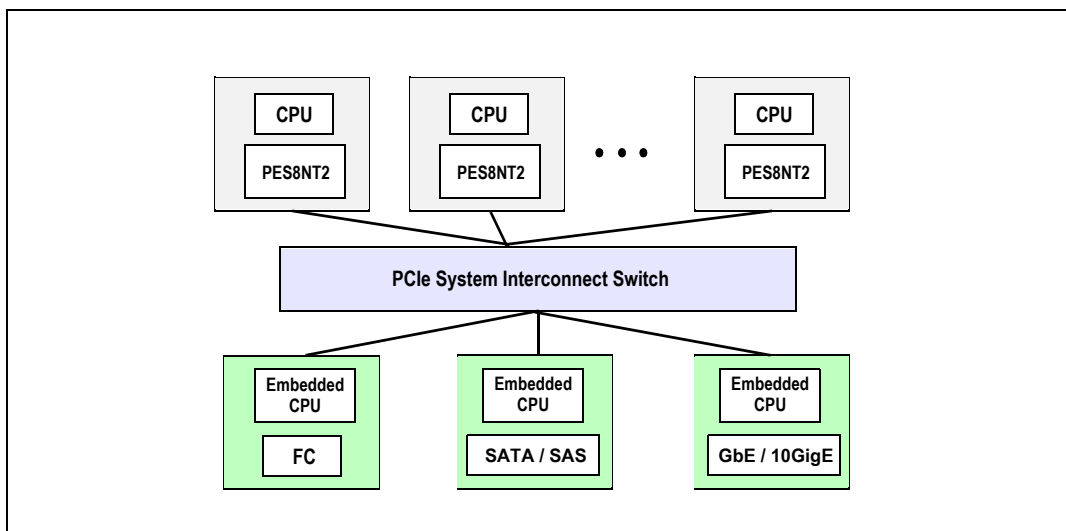

Figure 2 PCIe System Interconnect Architecture Block Diagram

Pin Description

The following tables list the functions of the pins provided on the PES8NT2. Some of the functions listed may be multiplexed onto the same pin. The active polarity of a signal is defined using a suffix. Signals ending with an “N” are defined as being active, or asserted, when at a logic zero (low) level. All other signals (including clocks, buses, and select lines) will be interpreted as being active, or asserted, when at a logic one (high) level.

Signal	Type	Name/Description
PEALREV	I	PCI Express Port A Lane Reverse. When this bit is asserted, the lanes of PCI Express Port A are reversed. This value may be overridden by modifying the value of the PALREV bit in the PA_SWCTL register.
PEARP[3:0] PEARN[3:0]	I	PCI Express Port A Serial Data Receive. Differential PCI Express receive pairs for port A.
PEATP[3:0] PEATN[3:0]	O	PCI Express Port A Serial Data Transmit. Differential PCI Express transmit pairs for port A
PECLREV	I	PCI Express Port C Lane Reverse. When this bit is asserted, the lanes of PCI Express Port C are reversed. This value may be overridden by modifying the value of the PCLREV bit in the PA_SWCTL register.
PECRP[3:0] PECRN[3:0]	I	PCI Express Port C Serial Data Receive. Differential PCI Express receive pairs for port C.
PECTP[3:0] PECTN[3:0]	O	PCI Express Port C Serial Data Transmit. Differential PCI Express transmit pairs for port C
PEREFCLKP[1:0] PEREFCLKN[1:0]	I	PCI Express Reference Clock. Differential reference clock pair input. This clock is used as the reference clock by on-chip PLLs to generate the clocks required for the system logic and on-chip SerDes. The frequency of the differential reference clock is determined by the REFCLKM signal.
REFCLKM	I	PCI Express Reference Clock Mode Select. These signals select the frequency of the reference clock input. 0x0 - 100 MHz 0x1 - 125 MHz

Table 1 PCI Express Interface Pins

Signal	Type	Name/Description
MSMBADDR[4:1]	I	Master SMBus Address. These pins determine the SMBus address of the serial EEPROM from which configuration information is loaded.
MSMBCLK	I/O	Master SMBus Clock. This bidirectional signal is used to synchronize transfers on the master SMBus. It is active and generating the clock only when the EEPROM is being accessed.
MSMBDAT	I/O	Master SMBus Data. This bidirectional signal is used for data on the master SMBus.
SSMBADDR[5,3:1]	I	Slave SMBus Address. These pins determine the SMBus address to which the slave SMBus interface responds.
SSMBCLK	I/O	Slave SMBus Clock. This bidirectional signal is used to synchronize transfers on the slave SMBus.
SSMBDAT	I/O	Slave SMBus Data. This bidirectional signal is used for data on the slave SMBus.

Table 2 SMBus Interface Pins

Signal	Type	Name/Description
GPIO[0]	I/O	General Purpose I/O. This pin can be configured as a general purpose I/O pin.
GPIO[1]	I/O	General Purpose I/O. This pin can be configured as a general purpose I/O pin. Alternate function pin name: PECRSTN Alternate function pin type: Output Alternate function: Reset output for downstream port C
GPIO[2]	I/O	General Purpose I/O. This pin can be configured as a general purpose I/O pin. Alternate function pin name: PALINKUPN Alternate function pin type: Output Alternate function: Port A link up status output
GPIO[3]	I/O	General Purpose I/O. This pin can be configured as a general purpose I/O pin.
GPIO[4]	I/O	General Purpose I/O. This pin can be configured as a general purpose I/O pin. Alternate function pin name: PCLINKUPN Alternate function pin type: Output Alternate function: Port C link up status output
GPIO[5]	I/O	General Purpose I/O. This pin can be configured as a general purpose I/O pin. Alternate function pin name: FAILOVERP Alternate function pin type: Input Alternate function: NTB upstream port failover
GPIO[6]	I/O	General Purpose I/O. This pin can be configured as a general purpose I/O pin.
GPIO[7]	I/O	General Purpose I/O. This pin can be configured as a general purpose I/O pin.

Table 3 General Purpose I/O Pins

Signal	Type	Name/Description
CCLKDS	I	Common Clock Downstream. When the CCLKDS pin is asserted, it indicates that a common clock is being used between the downstream device and the downstream port.
CCLKUS	I	Common Clock Upstream. When the CCLKUS pin is asserted, it indicates that a common clock is being used between the upstream device and the upstream port.
MSMBSMODE	I	Master SMBus Slow Mode. The assertion of this pin indicates that the master SMBus should operate at 100 KHz instead of 400 KHz. This value may not be overridden.
PENTBRSTN	I	Non-Transparent Bridge Reset. Assertion of this signal indicates a reset on the external side of the non-transparent bridge. This signal is only used when the switch mode selects a non-transparent mode and has no effect otherwise.
PERSTN	I	Fundamental Reset. Assertion of this signal resets all logic inside the PES8NT2 and initiates a PCI Express fundamental reset.
RSTHALT	I	Reset Halt. When this signal is asserted during a PCI Express fundamental reset, the PES8NT2 executes the reset procedure and remains in a reset state with the Master and Slave SMBuses active. This allows software to read and write registers internal to the device before normal device operation begins. The device exits the reset state when the RSTHALT bit is cleared in the PA_SWCTL register by an SMBus master.
SWMODE[3:0]	I	Switch Mode. These configuration pins determine the PES8NT2 switch operating mode. 0x0 - Transparent mode 0x1 - Transparent mode with serial EEPROM initialization 0x2 - Non-transparent mode 0x3 - Non-transparent mode with serial EEPROM initialization 0x4 - Non-transparent failover mode 0x5 - Non-transparent failover mode with serial EEPROM initialization 0x6 through 0xF - Reserved

Table 4 System Pins

Signal	Type	Name/Description
JTAG_TCK	I	JTAG Clock. This is an input test clock used to clock the shifting of data into or out of the boundary scan logic or JTAG Controller. JTAG_TCK is independent of the system clock with a nominal 50% duty cycle.
JTAG_TDI	I	JTAG Data Input. This is the serial data input to the boundary scan logic or JTAG Controller.

Table 5 Test Pins (Part 1 of 2)

Signal	Type	Name/Description
JTAG_TDO	O	JTAG Data Output. This is the serial data shifted out from the boundary scan logic or JTAG Controller. When no data is being shifted out, this signal is tri-stated.
JTAG_TMS	I	JTAG Mode. The value on this signal controls the test mode select of the boundary scan logic or JTAG Controller.
JTAG_TRST_N	I	JTAG Reset. This active low signal asynchronously resets the boundary scan logic and JTAG TAP Controller. An external pull-up on the board is recommended to meet the JTAG specification in cases where the tester can access this signal. However, for systems running in functional mode, one of the following should occur: 1) actively drive this signal low with control logic 2) statically drive this signal low with an external pull-down on the board

Table 5 Test Pins (Part 2 of 2)

Signal	Type	Name/Description
V _{DD} CORE	I	Core V_{DD}. Power supply for core logic.
V _{DD} IO	I	I/O V_{DD}. LVTTTL I/O buffer power supply.
V _{DD} PE	I	PCI Express Digital Power. PCI Express digital power used by the digital power of the SerDes.
V _{DD} APE	I	PCI Express Analog Power. PCI Express analog power used by the PLL and bias generator.
V _{TT} PE	I	PCI Express Termination Power.
V _{SS}	I	Ground.

Table 6 Power and Ground Pins

Pin Characteristics

Note: Some input pads of the PES8NT2 do not contain internal pull-ups or pull-downs. Unused inputs should be tied off to appropriate levels. This is especially critical for unused control signal inputs which, if left floating, could adversely affect operation. Also, any input pin left floating can cause a slight increase in power consumption.

Function	Pin Name	Type	Buffer	I/O Type	Internal Resistor	Notes
PCI Express Interface	PEALREV	I	LVTTTL	Input	pull-down	
	PEARN[3:0]	I	CML	Serial link		
	PEARP[3:0]	I				
	PEATN[3:0]	O				
	PEATP[3:0]	O				
	PECLREV	I			LVTTTL	Input
	PECRN[3:0]	I	CML	Serial link		
	PECRP[3:0]	I				
	PECTN[3:0]	O				
	PECTP[3:0]	O				
	PEREFCLKN[1:0]	I	LVPECL/ CML	Diff. Clock Input		Refer to Table 8
	PEREFCLKP[1:0]	I				
REFCLKM	I	LVTTTL	Input	pull-down		
SMBus	MSMBADDR[4:1]	I	LVTTTL	Input	pull-up	
	MSMBCLK	I/O		STI		
	MSMBDAT	I/O				
	SSMBADDR[5,3:1]	I		Input	pull-up	
	SSMBCLK	I/O		STI		
	SSMBDAT	I/O				
General Purpose I/O	GPIO[7:0]	I/O	LVTTTL	Input, High Drive	pull-up	
System Pins	CCLKDS	I	LVTTTL	Input	pull-up	
	CCLKUS	I			pull-up	
	MSMBSMODE	I			pull-down	
	PENTBRSTN	I				
	PERSTN	I				
	RSTHALT	I			pull-down	
	SWMODE[3:0]	I			pull-up	

Table 7 Pin Characteristics (Part 1 of 2)

Function	Pin Name	Type	Buffer	I/O Type	Internal Resistor	Notes
JTAG	JTAG_TCK	I	LVTTL	STI	pull-up	
	JTAG_TDI	I			pull-up	
	JTAG_TDO	O		Low Drive		
	JTAG_TMS	I		STI	pull-up	
	JTAG_TRST_N	I			pull-up	External pull-down

Table 7 Pin Characteristics (Part 2 of 2)

Logic Diagram — PES8NT2

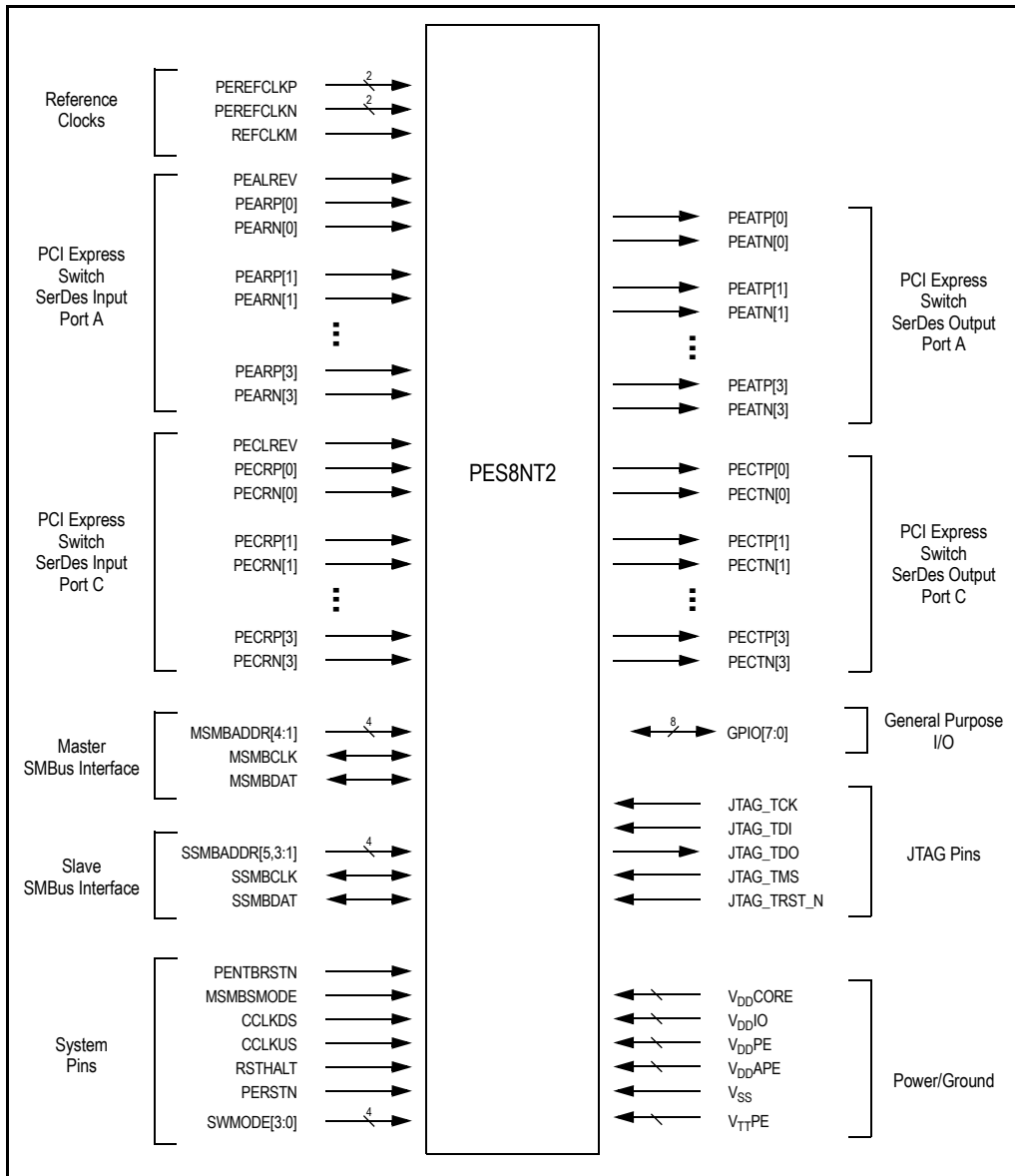

Figure 3 PES8NT2 Logic Diagram

System Clock Parameters

Values based on systems running at recommended supply voltages and operating temperatures, as shown in Tables 12 and 13.

Parameter	Description	Min	Typical	Max	Unit
Refclk _{FREQ}	Input reference clock frequency range	100		125 ¹	MHz
Refclk _{DC} ²	Duty cycle of input clock	40	50	60	%
T _R , T _F	Rise/Fall time of input clocks			0.2*RCUI	RCUI ³
V _{SW}	Differential input voltage swing ⁴	0.6		1.6	V
T _{jitter}	Input clock jitter (cycle-to-cycle)			125	ps
R _T	Termination Resistor		110		Ohms

Table 8 Input Clock Requirements

¹ The input clock frequency will be either 100 or 125 MHz depending on signal REFCLKM.

² ClkIn must be AC coupled. Use 0.01 — 0.1 μF ceramic capacitors.

³ RCUI (Reference Clock Unit Interval) refers to the reference clock period.

⁴ AC coupling required.

AC Timing Characteristics

Parameter	Description	Min ¹	Typical ¹	Max ¹	Units
PCIe Transmit					
UI	Unit Interval	399.88	400	400.12	ps
T _{TX-EYE}	Minimum Tx Eye Width	0.7	.9		UI
T _{TX-EYE-MEDIAN-to-MAX-JITTER}	Maximum time between the jitter median and maximum deviation from the median			0.15	UI
T _{TX-RISE} , T _{TX-FALL}	D+ / D- Tx output rise/fall time	50	90		ps
T _{TX-IDLE-MIN}	Minimum time in idle	50			UI
T _{TX-IDLE-SET-TO-IDLE}	Maximum time to transition to a valid Idle after sending an Idle ordered set			20	UI
T _{TX-IDLE-TO-DIFF-DATA}	Maximum time to transition from valid idle to diff data			20	UI
T _{TX-SKEW}	Transmitter data skew between any 2 lanes		500	1300	ps
PCIe Receive					
UI	Unit Interval	399.88	400	400.12	ps
T _{RX-EYE (with jitter)}	Minimum Receiver Eye Width (jitter tolerance)	0.4			UI

Table 9 PCIe AC Timing Characteristics (Part 1 of 2)

Parameter	Description	Min ¹	Typical ¹	Max ¹	Units
T _{RX-EYE-MEDIUM TO MAX JITTER}	Max time between jitter median & max deviation			0.3	UI
T _{RX-IDLE-DET-DIFF-ENTER TIME}	Unexpected Idle Enter Detect Threshold Integration Time			10	ms
T _{RX-SKEW}	Lane to lane input skew			20	ns

Table 9 PCIe AC Timing Characteristics (Part 2 of 2)

¹: Minimum, Typical, and Maximum values meet the requirements under PCI Specification 1.1

Signal	Symbol	Reference Edge	Min	Max	Unit	Timing Diagram Reference
GPIO						
GPIO[7:0] ¹	T _{pw_13b} ²	None	50	—	ns	

Table 10 GPIO AC Timing Characteristics

¹: GPIO signals must meet the setup and hold times if they are synchronous or the minimum pulse width if they are asynchronous.

²: The values for this symbol were determined by calculation, not by testing.

Signal	Symbol	Reference Edge	Min	Max	Unit	Timing Diagram Reference
JTAG						
JTAG_TCK	T _{per_16a}	none	50.0	—	ns	See Figure 4.
	T _{high_16a, Tlow_16a}		10.0	25.0	ns	
JTAG_TMS ¹ , JTAG_TDI	T _{su_16b}	JTAG_TCK rising	2.4	—	ns	
	T _{hld_16b}		1.0	—	ns	
JTAG_TDO	T _{do_16c}	JTAG_TCK falling	—	20	ns	
	T _{dz_16c} ²		—	20	ns	
JTAG_TRST_N	T _{pw_16d} ²	none	25.0	—	ns	

Table 11 JTAG AC Timing Characteristics

¹: The JTAG specification, IEEE 1149.1, recommends that JTAG_TMS should be held at 1 while the signal applied at JTAG_TRST_N changes from 0 to 1. Otherwise, a race may occur if JTAG_TRST_N is deasserted (going from low to high) on a rising edge of JTAG_TCK when JTAG_TMS is low, because the TAP controller might go to either the Run-Test/Idle state or stay in the Test-Logic-Reset state.

²: The values for this symbol were determined by calculation, not by testing.

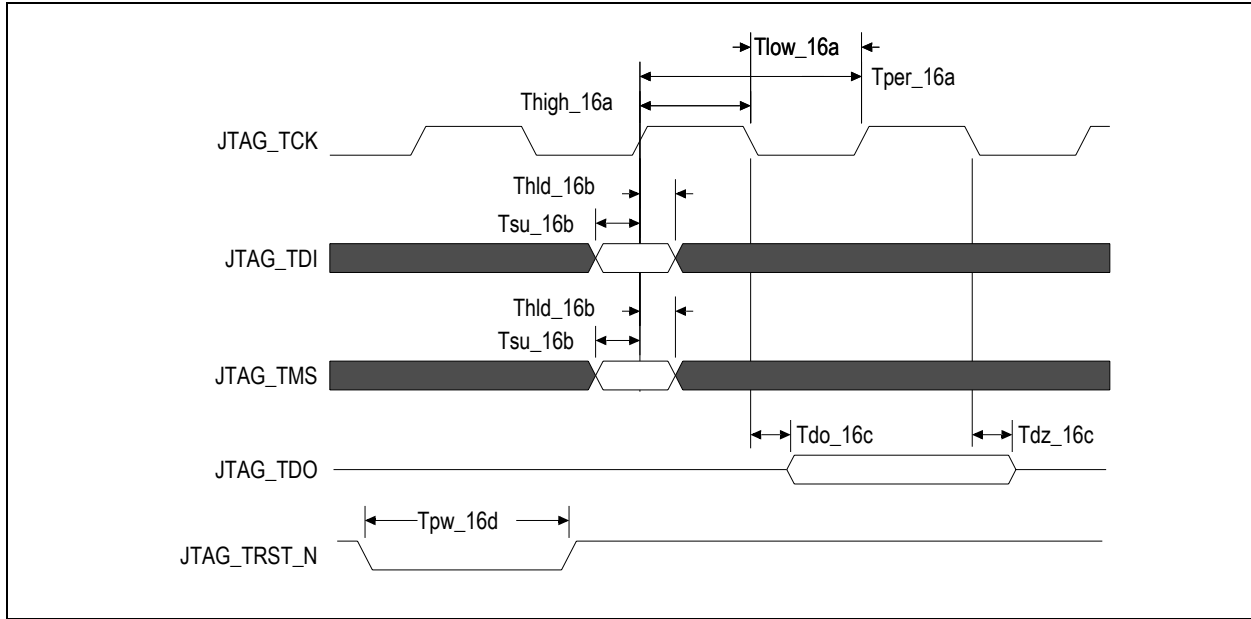

Figure 4 JTAG AC Timing Waveform

Recommended Operating Supply Voltages

Symbol	Parameter	Minimum	Typical	Maximum	Unit
V _{DD} CORE	Internal logic supply	0.9	1.0	1.1	V
V _{DD} I/O	I/O supply except for SerDes LVPECL/CML	3.0	3.3	3.6	V
V _{DD} PE	PCI Express Digital Power	0.9	1.0	1.1	V
V _{DD} APE	PCI Express Analog Power	0.9	1.0	1.1	V
V _{TT} PE	PCI Express Serial Data Transmit Termination Voltage	1.425	1.5	1.575	V
V _{SS}	Common ground	0	0	0	V

Table 12 PES8NT2 Operating Voltages

Power-Up Sequence

This section describes the sequence in which various voltages must be applied to the part during power-up to ensure proper functionality. For the PES8NT2, the power-up sequence must be as follows:

1. V_{DD}I/O — 3.3V
2. V_{DD}Core, V_{DD}PE, V_{DD}APE — 1.0V
3. V_{TT}PE — 1.5V

When powering up, each voltage level must ramp and stabilize prior to applying the next voltage in the sequence to ensure internal latch-up issues are avoided. There are no maximum time limitations in ramping to valid power levels. The power-down sequence must be in the reverse order of the power-up sequence.

Recommended Operating Temperature

Grade	Temperature
Commercial	0°C to +70°C Ambient

Table 13 PES8NT2 Operating Temperatures

Power Consumption

Typical power is measured under the following conditions: 25°C Ambient, 35% total link usage on all ports, typical voltages defined in Table 14.

Maximum power is measured under the following conditions: 70°C Ambient, 85% total link usage on all ports, maximum voltages defined in Table 14.

All power measurements assume that the part is mounted on a 10 layer printed circuit board with 0 LFM airflow.

Number of Connected Lanes: Port-A/Port-C	Core (Watts) (1.0V supply)		PCIe Digital (Watts) (1.0V supply)		PCIe Analog (Watts) (1.0V supply)		PCIe Termin- ation (Watts) (1.5V supply)		I/O (Watts) (3.3V supply)		Total (Watts)	
	Typ	Max	Typ	Max	Typ	Max	Typ	Max	Typ	Max	Typ	Max
4/4	220	390	300	450	100	150	100	210	3	3		
	0.22	0.43	0.30	0.50	0.10	0.17	0.15	0.33	0.01	0.01	0.78	1.43

Table 14 PES8NT2 Power Consumption

Thermal Considerations

This section describes thermal considerations for the PES8NT2 (19mm² BCG324 package). The data in Table 15 below contains information that is relevant to the thermal performance of the PES8NT2 switch.

Symbol	Parameter	Value	Units	Conditions
$T_{J(max)}$	Junction Temperature	125	°C	Maximum
$T_{A(max)}$	Ambient Temperature	70	°C	Maximum for commercial-rated products
$\theta_{JA(effective)}$	Effective Thermal Resistance, Junction-to-Ambient	21.8	°C/W	Zero air flow
		15.1	°C/W	1 m/S air flow
		13.9	°C/W	2 m/S air flow
θ_{JB}	Thermal Resistance, Junction-to-Board	11.4	°C/W	
θ_{JC}	Thermal Resistance, Junction-to-Case	5.1	°C/W	
P	Power Dissipation of the Device	1.43	Watts	Maximum

Table 15 Thermal Specifications for PES8NT2, 19x19mm BCG324 Package

Note: The parameter $\theta_{JA(eff)}$ is not the *absolute* thermal resistance for the package as defined by JEDEC (JESD-51). Because resistance can vary with the number of board layers, size of the board, and airflow, $\theta_{JA(eff)}$ is the *effective* thermal resistance. The values for effective θ_{JA} given above are based on a 10-layer, standard height, full length (4.3"x12.2") PCIe add-in card.

DC Electrical Characteristics

Values based on systems running at recommended supply voltages, as shown in Table 12.

Note: See Table 7, Pin Characteristics, for a complete I/O listing.

I/O Type	Parameter	Description	Min ¹	Typ ¹	Max ¹	Unit	Conditions
Serial Link	PCIe Transmit						
	$V_{TX-DIFFp-p}$	Differential peak-to-peak output voltage	800		1200	mV	
	$V_{TX-DE-RATIO}$	De-emphasized differential output voltage	-3		-4	dB	
	$V_{TX-DC-CM}$	DC Common mode voltage	-0.1	1	3.7	V	
	$V_{TX-CM-ACP}$	RMS AC peak common mode output voltage			20	mV	
	$V_{TX-CM-DC-active-idle-delta}$	Abs delta of DC common mode voltage between L0 and idle			100	mV	
	$V_{TX-CM-DC-line-delta}$	Abs delta of DC common mode voltage between D+ and D-			25	mV	
	$V_{TX-Idle-DiffP}$	Electrical idle diff peak output			20	mV	
Serial Link (cont.)	$V_{TX-RCV-Detect}$	Voltage change during receiver detection			600	mV	
	$RL_{TX-DIFF}$	Transmitter Differential Return loss	12			dB	
	RL_{TX-CM}	Transmitter Common Mode Return loss	6			dB	
	$Z_{TX-DEFF-DC}$	DC Differential TX impedance	80	100	120	Ω	
	Z_{OSE}	Single ended TX Impedance	40	50	60	Ω	
	Transmitter Eye Diagram	TX Eye Height (De-emphasized bits)	505	650		mV	
	Transmitter Eye Diagram	TX Eye Height (Transition bits)	800	950		mV	
	PCIe Receive						
	$V_{RX-DIFFp-p}$	Differential input voltage (peak-to-peak)	175		1200	mV	
	$V_{RX-CM-AC}$	Receiver common-mode voltage for AC coupling			150	mV	
	$RL_{RX-DIFF}$	Receiver Differential Return Loss	15			dB	
	RL_{RX-CM}	Receiver Common Mode Return Loss	6			dB	
	$Z_{RX-DIFF-DC}$	Differential input impedance (DC)	80	100	120	Ω	
	$Z_{RX-COMM-DC}$	Single-ended input impedance	40	50	60	Ω	
$Z_{RX-COMM-HIGH-Z-DC}$	Powered down input common mode impedance (DC)	200k	350k		Ω		
$V_{RX-IDLE-DET-DIFFp-p}$	Electrical idle detect threshold	65		175	mV		
PCIe REFCLK							
	C_{IN}	Input Capacitance	1.5	—		pF	

Table 16 DC Electrical Characteristics (Part 1 of 2)

I/O Type	Parameter	Description	Min ¹	Typ ¹	Max ¹	Unit	Conditions
Other I/Os							
LOW Drive Output	I _{OL}		—	2.5	—	mA	V _{OL} = 0.4v
	I _{OH}		—	-5.5	—	mA	V _{OH} = 1.5V
High Drive Output	I _{OL}		—	12.0	—	mA	V _{OL} = 0.4v
	I _{OH}		—	-20.0	—	mA	V _{OH} = 1.5V
Schmitt Trigger Input (STI)	V _{IL}		-0.3	—	0.8	V	—
	V _{IH}		2.0	—	V _{DD} IO+0.5	V	—
Input	V _{IL}		-0.3	—	0.8	V	—
	V _{IH}		2.0	—	V _{DD} IO+0.5	V	—
Capacitance	C _{IN}		—	—	8.5	pF	—
Leakage	Inputs		—	—	± 10	μA	V _{DD} I/O (max)
	I/O _{LEAK} w/o Pull-ups/downs		—	—	± 10	μA	V _{DD} I/O (max)
	I/O _{LEAK} WITH Pull-ups/downs		—	—	± 80	μA	V _{DD} I/O (max)

Table 16 DC Electrical Characteristics (Part 2 of 2)

¹: Minimum, Typical, and Maximum values meet the requirements under PCI Specification 1.0a.

Package Pinout — 324-BGA Signal Pinout for PES8NT2

The following table lists the pin numbers and signal names for the PES8NT2 device.

Pin	Function	Alt	Pin	Function	Alt	Pin	Function	Alt	Pin	Function	Alt
A1	V _{SS}		E10	V _{DD} PE		K1	V _{DD} CORE		P10	V _{DD} IO	
A2	V _{SS}		E11	V _{SS}		K2	V _{SS}		P11	V _{DD} IO	
A3	PEARP03		E12	V _{DD} PE		K3	V _{TT} PE		P12	V _{DD} IO	
A4	V _{DD} CORE		E13	V _{SS}		K4	V _{DD} CORE		P13	V _{DD} IO	
A5	PEATN03		E14	V _{DD} CORE		K5	V _{DD} PE		P14	V _{DD} IO	
A6	V _{DD} CORE		E15	V _{DD} APE		K6	V _{SS}		P15	V _{SS}	
A7	PEATP02		E16	V _{SS}		K7	V _{SS}		P16	V _{TT} PE	
A8	V _{DD} CORE		E17	PECTP03		K8	V _{SS}		P17	V _{SS}	
A9	PEARNO2		E18	PECTN03		K9	V _{SS}		P18	V _{DD} CORE	
A10	V _{DD} CORE		F1	V _{DD} CORE		K10	V _{SS}		R1	NC	
A11	PEARP01		F2	V _{SS}		K11	V _{SS}		R2	NC	
A12	V _{DD} CORE		F3	V _{DD} CORE		K12	V _{SS}		R3	V _{SS}	
A13	PEATP01		F4	V _{DD} APE		K13	V _{SS}		R4	V _{DD} IO	
A14	V _{DD} CORE		F5	V _{SS}		K14	V _{SS}		R5	V _{SS}	
A15	V _{DD} CORE		F6	V _{DD} CORE		K15	V _{DD} PE		R6	V _{DD} CORE	
A16	PEATN00		F7	V _{SS}		K16	V _{TT} PE		R7	MSMBDAT	
A17	V _{SS}		F8	V _{DD} CORE		K17	V _{SS}		R8	SSMBADDR_5	
A18	V _{SS}		F9	V _{SS}		K18	V _{DD} CORE		R9	PEALREV	
B1	V _{DD} CORE		F10	V _{DD} CORE		L1	V _{SS}		R10	SWMODE_2	
B2	V _{DD} CORE		F11	V _{SS}		L2	V _{SS}		R11	RSTHALT	
B3	PEARNO3		F12	V _{SS}		L3	V _{SS}		R12	GPIO_04	1
B4	V _{SS}		F13	V _{DD} PE		L4	V _{DD} PE		R13	V _{DD} CORE	
B5	PEATP03		F14	V _{SS}		L5	V _{SS}		R14	V _{SS}	
B6	V _{SS}		F15	V _{DD} IO		L6	V _{DD} CORE		R15	V _{DD} IO	
B7	PEATN02		F16	V _{SS}		L7	V _{DD} CORE		R16	V _{SS}	
B8	V _{SS}		F17	V _{SS}		L8	V _{DD} CORE		R17	PECTP00	
B9	PEARP02		F18	V _{DD} CORE		L9	V _{DD} CORE		R18	PECTN00	
B10	V _{SS}		G1	NC		L10	V _{DD} CORE		T1	V _{DD} CORE	
B11	PEARNO1		G2	NC		L11	V _{DD} CORE		T2	V _{SS}	
B12	V _{SS}		G3	V _{SS}		L12	V _{DD} CORE		T3	V _{SS}	
B13	PEATN01		G4	V _{DD} PE		L13	V _{DD} CORE		T4	JTAG_TCK	
B14	V _{SS}		G5	V _{DD} APE		L14	V _{SS}		T5	JTAG_TDO	
B15	V _{SS}		G6	V _{SS}		L15	V _{DD} PE		T6	MSMBADDR_1	
B16	PEATP00		G7	V _{SS}		L16	V _{SS}		T7	MSMBCLK	

Table 17 PES8NT2 324-pin Signal Pin-Out (Part 1 of 3)

Pin	Function	Alt	Pin	Function	Alt	Pin	Function	Alt	Pin	Function	Alt
B17	V _{DD} CORE		G8	V _{DD} IO		L17	PECRP01		T8	SSMBADDR_2	
B18	V _{DD} CORE		G9	V _{SS}		L18	PECRN01		T9	CCLKDS	
C1	V _{SS}		G10	V _{DD} IO		M1	V _{DD} CORE		T10	SWMODE_1	
C2	V _{SS}		G11	V _{SS}		M2	V _{SS}		T11	PERSTN	
C3	V _{SS}		G12	V _{DD} CORE		M3	V _{SS}		T12	GPIO_03	
C4	V _{DD} CORE		G13	V _{SS}		M4	V _{DD} APE		T13	GPIO_07	
C5	V _{SS}		G14	V _{DD} APE		M5	V _{SS}		T14	V _{SS}	
C6	V _{TT} PE		G15	V _{DD} PE		M6	V _{DD} CORE		T15	REFCLKM	
C7	V _{SS}		G16	V _{SS}		M7	V _{SS}		T16	V _{SS}	
C8	V _{TT} PE		G17	PECTN02		M8	V _{SS}		T17	V _{SS}	
C9	V _{SS}		G18	PECTP02		M9	V _{DD} CORE		T18	V _{DD} CORE	
C10	V _{TT} PE		H1	V _{DD} CORE		M10	V _{DD} CORE		U1	V _{SS}	
C11	V _{SS}		H2	V _{SS}		M11	V _{SS}		U2	V _{SS}	
C12	V _{TT} PE		H3	V _{TT} PE		M12	V _{SS}		U3	V _{SS}	
C13	V _{DD} CORE		H4	V _{DD} APE		M13	V _{DD} CORE		U4	JTAG_TDI	
C14	PEARP00		H5	V _{SS}		M14	V _{SS}		U5	JTAG_TMS	
C15	PEARN00		H6	V _{SS}		M15	V _{DD} APE		U6	MSMBADDR_2	
C16	V _{DD} CORE		H7	V _{DD} CORE		M16	V _{SS}		U7	MSMBADDR_4	
C17	PECRN03		H8	V _{SS}		M17	V _{SS}		U8	SSMBADDR_3	
C18	PECRP03		H9	V _{DD} CORE		M18	V _{DD} CORE		U9	CCLKUS	
D1	V _{DD} CORE		H10	V _{DD} CORE		N1	NC		U10	SWMODE_0	
D2	V _{SS}		H11	V _{SS}		N2	NC		U11	PECLREV	
D3	V _{SS}		H12	V _{DD} CORE		N3	V _{TT} PE		U12	GPIO_00	
D4	V _{DD} CORE		H13	V _{SS}		N4	V _{DD} APE		U13	GPIO_02	1
D5	V _{SS}		H14	V _{DD} APE		N5	V _{SS}		U14	GPIO_06	
D6	V _{DD} APE		H15	V _{DD} PE		N6	V _{SS}		U15	MSMBSMODE	
D7	V _{SS}		H16	V _{TT} PE		N7	V _{SS}		U16	V _{SS}	
D8	V _{DD} APE		H17	V _{SS}		N8	V _{SS}		U17	PECRN00	
D9	V _{SS}		H18	V _{DD} CORE		N9	V _{SS}		U18	PECRP00	
D10	V _{DD} APE		J1	V _{SS}		N10	V _{SS}		V1	V _{DD} CORE	
D11	V _{SS}		J2	V _{SS}		N11	V _{SS}		V2	V _{SS}	
D12	V _{DD} APE		J3	V _{SS}		N12	V _{SS}		V3	PEREFCLKP0	
D13	V _{SS}		J4	V _{DD} PE		N13	V _{SS}		V4	PEREFCLKN0	
D14	V _{DD} CORE		J5	V _{SS}		N14	V _{SS}		V5	JTAG_TRST_N	
D15	V _{SS}		J6	V _{DD} CORE		N15	V _{DD} APE		V6	MSMBADDR_3	
D16	V _{SS}		J7	V _{SS}		N16	V _{TT} PE		V7	SSMBADDR_1	
D17	V _{SS}		J8	V _{SS}		N17	PECTN01		V8	SSMBCLK	

Table 17 PES8NT2 324-pin Signal Pin-Out (Part 2 of 3)

Pin	Function	Alt	Pin	Function	Alt	Pin	Function	Alt	Pin	Function	Alt
D18	V _{DD} CORE		J9	V _{DD} CORE		N18	PECTP01		V9	SSMBDAT	
E1	NC		J10	V _{DD} CORE		P1	V _{DD} CORE		V10	V _{SS}	
E2	NC		J11	V _{SS}		P2	V _{SS}		V11	SWMODE_3	
E3	V _{DD} CORE		J12	V _{SS}		P3	V _{TT} PE		V12	PENTBRSTN	
E4	V _{SS}		J13	V _{DD} CORE		P4	V _{SS}		V13	GPIO_01	1
E5	V _{DD} CORE		J14	V _{SS}		P5	V _{DD} IO		V14	GPIO_05	1
E6	V _{SS}		J15	V _{DD} CORE		P6	V _{DD} IO		V15	PEREFCLKP1	
E7	V _{SS}		J16	V _{SS}		P7	V _{DD} IO		V16	PEREFCLKN1	
E8	V _{DD} PE		J17	PECRP02		P8	V _{DD} IO		V17	V _{SS}	
E9	V _{SS}		J18	PECRN02		P9	V _{DD} IO		V18	V _{DD} CORE	

Table 17 PES8NT2 324-pin Signal Pin-Out (Part 3 of 3)

Alternate Signal Functions

Pin	GPIO	Alternate
V13	GPIO_01	PECRSTN
U13	GPIO_02	PALINKUP
R12	GPIO_04	PCLINKUP
V14	GPIO_05	FAILOVERP

Table 18 PES8NT2 Alternate Signal Functions

No Connection Pins

Pin	Pin
E1	N1
E2	N2
G1	R1
G2	R2

Table 19 PES8NT2 No Connection Pins

Power Pins

V_{DD}Core	V_{DD}Core	V_{DD}Core	V_{DD}IO	V_{DD}PE	V_{DD}APE	V_{TT}PE
A4	F3	L8	F15	E8	D6	C6
A6	F6	L9	G8	E10	D8	C8
A8	F8	L10	G10	E12	D10	C10
A10	F10	L11	P5	F13	D12	C12
A12	F18	L12	P6	G4	E15	H3
A14	G12	L13	P7	G15	F4	H16
A15	H1	M1	P8	H15	G5	K3
B1	H7	M6	P9	J4	G14	K16
B2	H9	M9	P10	K5	H4	N3
B17	H10	M10	P11	K15	H14	N16
B18	H12	M13	P12	L4	M4	P3
C4	H18	M18	P13	L15	M15	P16
C13	J6	P1	P14		N4	
C16	J9	P18	R4		N15	
D1	J10	R6	R15			
D4	J13	R13				
D14	J15	T1				
D18	K1	T18				
E3	K4	V1				
E5	K18	V18				
E14	L6					
F1	L7					

Table 20 PES8NT2 Power Pins

Ground Pins

V_{SS}	V_{SS}	V_{SS}	V_{SS}	V_{SS}
A1	D16	G16	K13	N12
A2	D17	H2	K14	N13
A17	E4	H5	K17	N14
A18	E6	H6	L3	P2
B4	E7	H8	L5	P4
B6	E9	H11	L14	P15
B8	E11	H13	L16	P17
B10	E13	H17	M2	R3
B12	E16	J3	M3	R5
B14	F2	J5	M5	R14
B15	F5	J7	M7	R16
C3	F7	J8	M8	T2
C5	F9	J11	M11	T3
C7	F11	J12	M12	T16
C9	F12	J14	M14	T17
C11	F14	J16	M16	U3
D2	F16	K2	M17	U16
D3	F17	K6	N5	V2
D5	G3	K7	N6	V10
D7	G6	K8	N7	V17
D9	G7	K9	N8	
D11	G9	K10	N9	
D13	G11	K11	N10	
D15	G13	K12	N11	

Table 21 PES8NT2 Ground Pins

Signals Listed Alphabetically

Signal Name	I/O Type	Location	Signal Category
CCLKDS	I	T9	System
CCLKUS	I	U9	
GPIO_00	I/O	U12	General Purpose Input/Output
GPIO_01	I/O	V13	
GPIO_02	I/O	U13	
GPIO_03	I/O	T12	
GPIO_04	I/O	R12	
GPIO_05	I/O	V14	
GPIO_06	I/O	U14	
GPIO_07	I/O	T13	
JTAG_TCK	I	T4	
JTAG_TDI	I	U4	
JTAG_TDO	O	T5	
JTAG_TMS	I	U5	
JTAG_TRST_N	I	V5	
MSMBADDR_1	I	T6	SMBus
MSMBADDR_2	I	U6	
MSMBADDR_3	I	V6	
MSMBADDR_4	I	U7	
MSMBCLK	I/O	T7	
MSMBDAT	I/O	R7	
MSMBSMODE	I	U15	System
No Connect	See Table 19 for a list of no connect pins		

Table 22 PES8NT2 Alphabetical Signal List (Part 1 of 3)

Signal Name	I/O Type	Location	Signal Category
PEALREV	I	R9	PCI Express
PEARN00	I	C15	
PEARN01	I	B11	
PEARN02	I	A9	
PEARN03	I	B3	
PEARP00	I	C14	
PEARP01	I	A11	
PEARP02	I	B9	
PEARP03	I	A3	
PEATN00	O	A16	
PEATN01	O	B13	
PEATN02	O	B7	
PEATN03	O	A5	
PEATP00	O	B16	
PEATP01	O	A13	
PEATP02	O	A7	
PEATP03	O	B5	
PECLREV	I	U11	
PECRN00	I	U17	
PECRN01	I	L18	
PECRN02	I	J18	
PECRN03	I	C17	
PECRP00	I	U18	
PECRP01	I	L17	
PECRP02	I	J17	
PECRP03	I	C18	
PECTN00	O	R18	
PECTN01	O	N17	
PECTN02	O	G17	
PECTN03	O	E18	
PECTP00	O	R17	
PECTP01	O	N18	
PECTP02	O	G18	
PECTP03	O	E17	
PENTBRSTN	I	V12	System

Table 22 PES8NT2 Alphabetical Signal List (Part 2 of 3)

Signal Name	I/O Type	Location	Signal Category
PEREFCLKN0	I	V4	PCI Express
PEREFCLKN1	I	V16	
PEREFCLKP0	I	V3	
PEREFCLKP1	I	V15	
PERSTN	I	T11	System
REFCLKM	I	T15	PCI Express
RSTHALT	I	R11	System
SSMBADDR_1	I	V7	SMBus
SSMBADDR_2	I	T8	
SSMBADDR_3	I	U8	
SSMBADDR_5	I	R8	
SSMBCLK	I/O	V8	SMBus
SSMBDAT	I/O	V9	
SWMODE_0	I	U10	System
SWMODE_1	I	T10	
SWMODE_2	I	R10	
SWMODE_3	I	V11	System
V _{DD} CORE, V _{DD} APE, V _{DD} IO, V _{DD} PE, V _{TT} PE	See Table 20 for a listing of power pins.		
V _{SS}	See Table 21 for a listing of ground pins.		

Table 22 PES8NT2 Alphabetical Signal List (Part 3 of 3)

PES8NT2 Pinout — Top View

	1	2	3	4	5	6	7	8	9	10	11	12	13	14	15	16	17	18
A																		
B																		
C																		
D																		
E																		
F																		
G																		
H																		
J																		
K																		
L																		
M																		
N																		
P																		
R																		
T																		
U																		
V																		

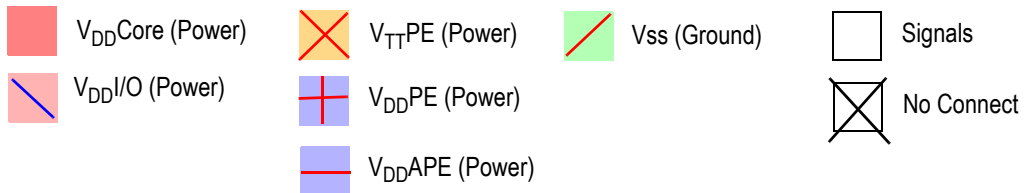

PES8NT2 Package Drawing — 324-Pin BC324/BCG324

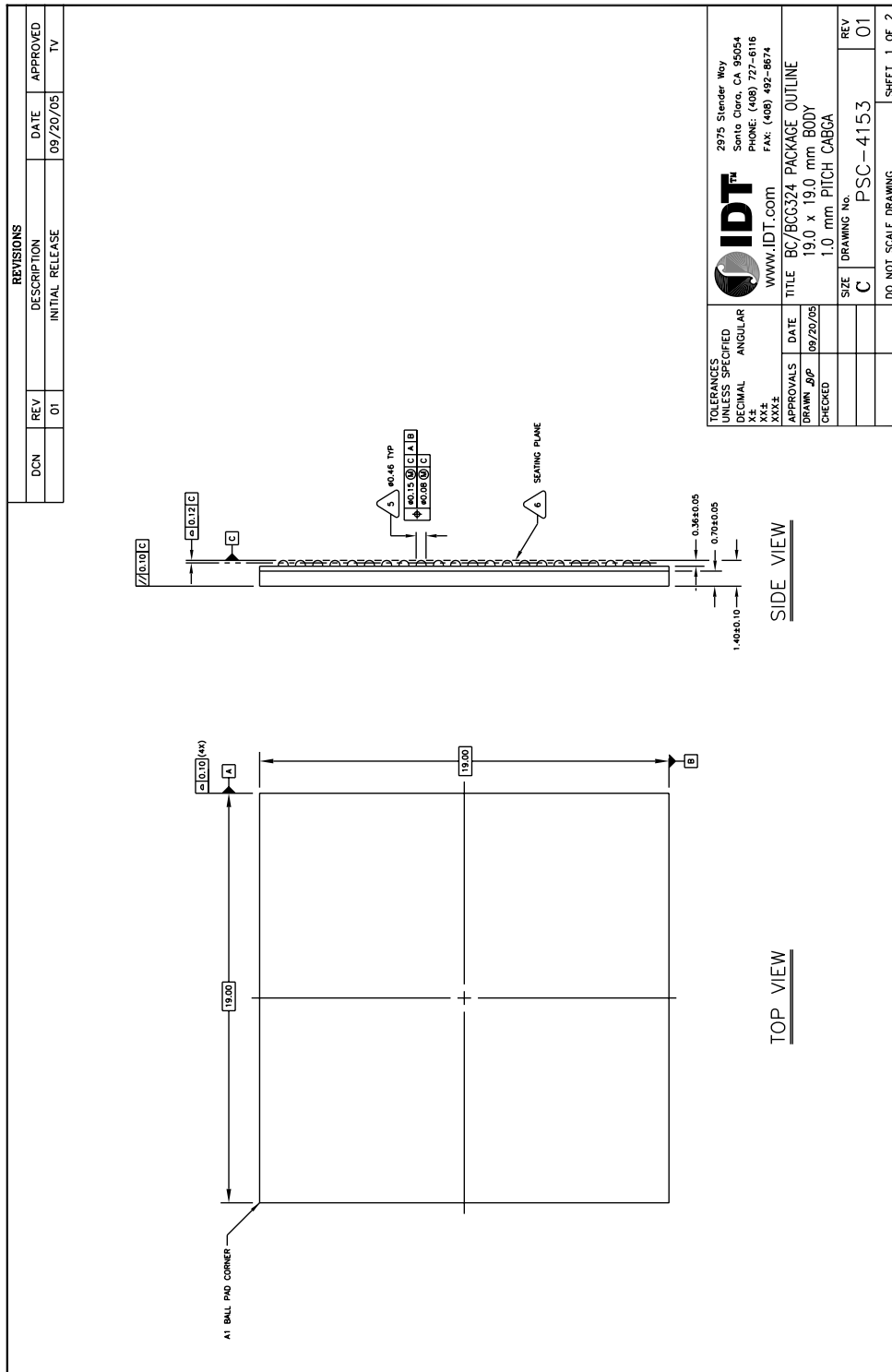

PES8NT2 Package Drawing — Page Two

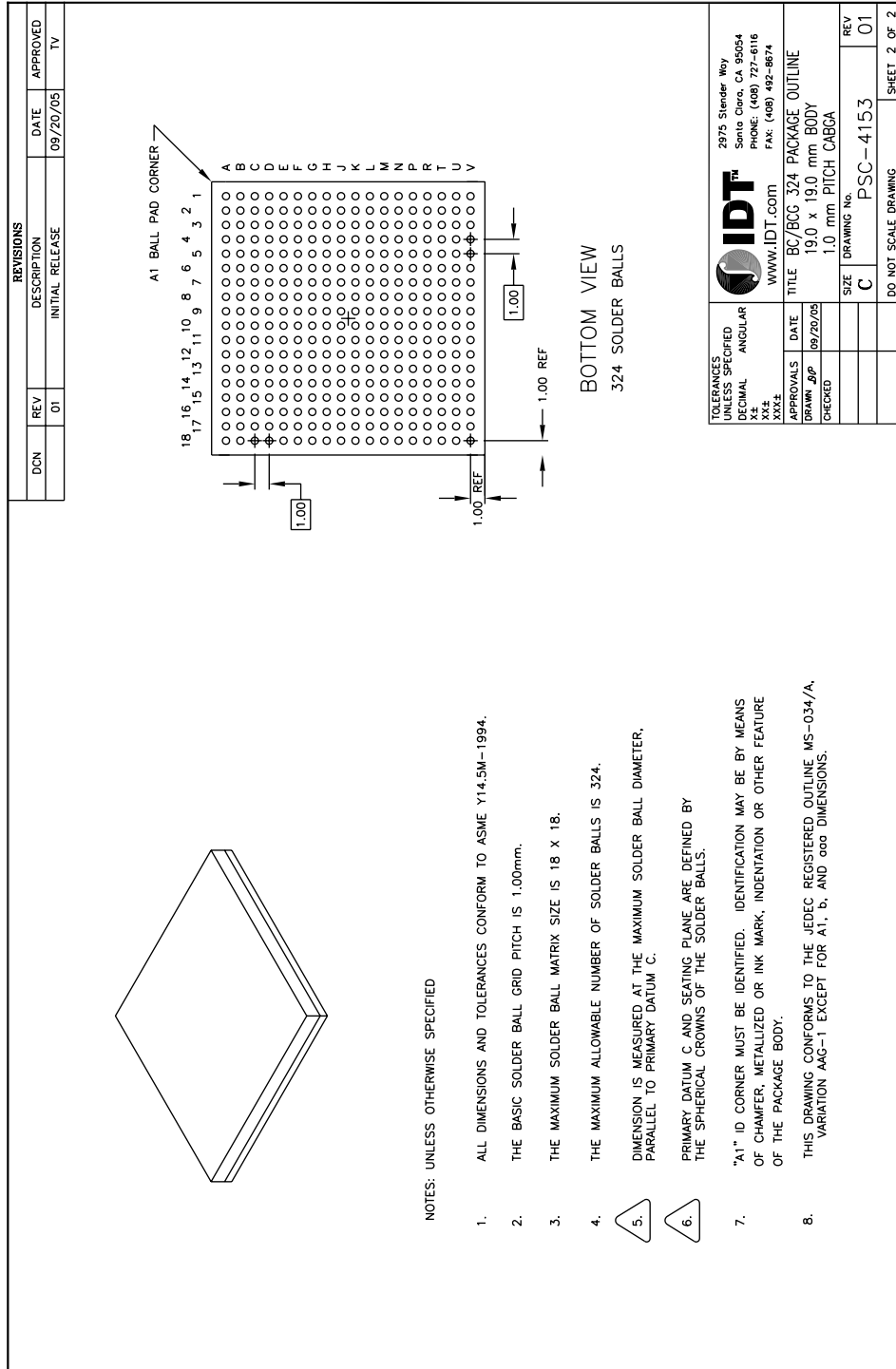

TOLERANCES UNLESS SPECIFIED	IDT™	2975 Slender Way	Santa Clara, CA 95054
DECIMAL	www.IDT.com	PHONE: (408) 727-6116	FAX: (408) 492-8674
ANGULAR			
X.X			
X.XX			
APPROVALS	DATE	TITLE	
DRAWN_jpp	09/20/05	BC/BCC 324 PACKAGE OUTLINE	
CHECKED		19.0 x 19.0 mm BODY	
		1.0 mm PITCH CABGA	
		SIZE	REV
		DRAWING No.	01
		PSC-4153	
DO NOT SCALE DRAWING			SHEET 2 OF 2

Revision History

April 15, 2008: Initial publication of data sheet.

January 5, 2009: On the Ordering Information page, changed silicon revision from ZA to ZB.

Ordering Information

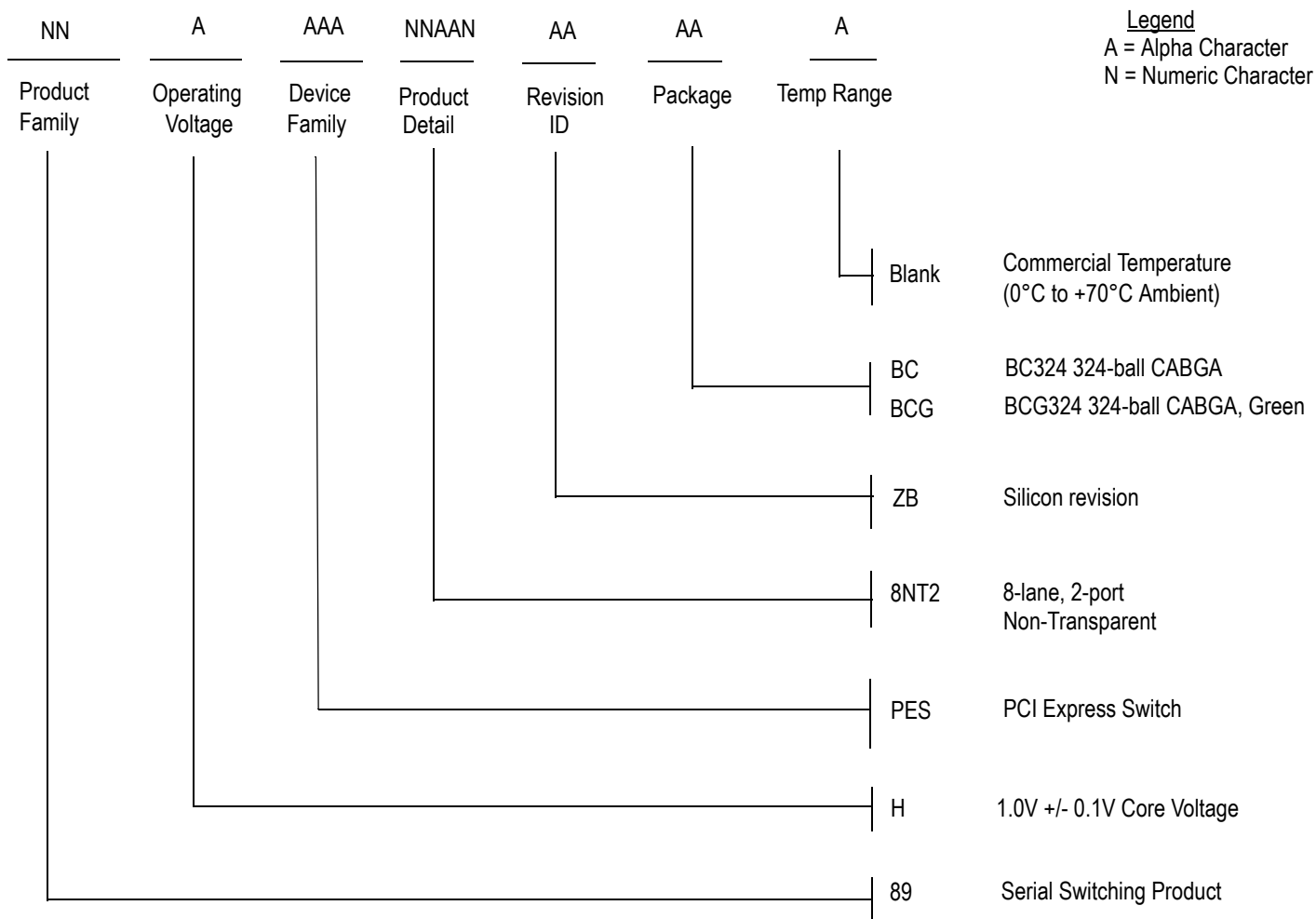

Legend

A = Alpha Character
N = Numeric Character

Valid Combinations

- 89HPES8NT2ZBBC 324-pin BC324 package, Commercial Temperature
- 89HPES8NT2ZBBCG 324-pin Green BC324 package, Commercial Temperature

IMPORTANT NOTICE AND DISCLAIMER

RENESAS ELECTRONICS CORPORATION AND ITS SUBSIDIARIES (“RENESAS”) PROVIDES TECHNICAL SPECIFICATIONS AND RELIABILITY DATA (INCLUDING DATASHEETS), DESIGN RESOURCES (INCLUDING REFERENCE DESIGNS), APPLICATION OR OTHER DESIGN ADVICE, WEB TOOLS, SAFETY INFORMATION, AND OTHER RESOURCES “AS IS” AND WITH ALL FAULTS, AND DISCLAIMS ALL WARRANTIES, EXPRESS OR IMPLIED, INCLUDING, WITHOUT LIMITATION, ANY IMPLIED WARRANTIES OF MERCHANTABILITY, FITNESS FOR A PARTICULAR PURPOSE, OR NON-INFRINGEMENT OF THIRD PARTY INTELLECTUAL PROPERTY RIGHTS.

These resources are intended for developers skilled in the art designing with Renesas products. You are solely responsible for (1) selecting the appropriate products for your application, (2) designing, validating, and testing your application, and (3) ensuring your application meets applicable standards, and any other safety, security, or other requirements. These resources are subject to change without notice. Renesas grants you permission to use these resources only for development of an application that uses Renesas products. Other reproduction or use of these resources is strictly prohibited. No license is granted to any other Renesas intellectual property or to any third party intellectual property. Renesas disclaims responsibility for, and you will fully indemnify Renesas and its representatives against, any claims, damages, costs, losses, or liabilities arising out of your use of these resources. Renesas' products are provided only subject to Renesas' Terms and Conditions of Sale or other applicable terms agreed to in writing. No use of any Renesas resources expands or otherwise alters any applicable warranties or warranty disclaimers for these products.

(Disclaimer Rev.1.0 Mar 2020)

Corporate Headquarters

TOYOSU FORESIA, 3-2-24 Toyosu,
Koto-ku, Tokyo 135-0061, Japan
www.renesas.com

Contact Information

For further information on a product, technology, the most up-to-date version of a document, or your nearest sales office, please visit:
www.renesas.com/contact/

Trademarks

Renesas and the Renesas logo are trademarks of Renesas Electronics Corporation. All trademarks and registered trademarks are the property of their respective owners.