

International **IR** Rectifier

8ETU04PbF

Ultrafast Rectifier

Features

- Ultrafast Recovery Time
- Low Forward Voltage Drop
- Low Leakage Current
- 175°C Operating Junction Temperature
- Lead-Free ("PbF" data sheet)

$t_{rr} = 60ns$
$I_{F(AV)} = 8Amp$
$V_R = 400V$

Description/ Applications

International Rectifier's FRED.. series are the state of the art Ultra fast recovery rectifiers specifically designed with optimized performance of forward voltage drop and ultra fast recovery time.

The planar structure and the platinum doped life time control, guarantee the best overall performance, ruggedness and reliability characteristics.

These devices are intended for use in the output rectification stage of SMPS, UPS, DC-DC converters as well as free-wheeling diode in low voltage inverters and chopper motor drives.

Their extremely optimized stored charge and low recovery current minimize the switching losses and reduce over dissipation in the switching element and snubbers.

www.DataSheet4U.com

Absolute Maximum Ratings

Parameters	Max	Units
V_{RRM} Peak Repetitive Peak Reverse Voltage	400	V
$I_{F(AV)}$ Average Rectified Forward Current, $T_C = 155^\circ C$	8	A
I_{FSM} Non Repetitive Peak Surge Current, $T_C = 25^\circ C$	100	
I_{FRM} Peak Repetitive Forward Current	16	
T_J, T_{STG} Operating Junction and Storage Temperatures	- 65 to 175	$^\circ C$

Case Styles



TO-220AC

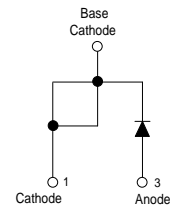

Electrical Characteristics @ $T_J = 25^\circ\text{C}$ (unless otherwise specified)

Parameters	Min	Typ	Max	Units	Test Conditions
V_{BR}, V_f Breakdown Voltage, Blocking Voltage	400	-	-	V	$I_R = 100\mu\text{A}$
V_F Forward Voltage	-	1.19	1.3	V	$I_F = 8\text{A}$
	-	0.94	1.0	V	$I_F = 8\text{A}, T_J = 150^\circ\text{C}$
I_R Reverse Leakage Current	-	0.2	10	μA	$V_R = V_R \text{ Rated}$
	-	20	500	μA	$T_J = 150^\circ\text{C}, V_R = V_R \text{ Rated}$
C_T Junction Capacitance	-	14	-	pF	$V_R = 400\text{V}$
L_S Series Inductance	-	8.0	-	nH	Measured lead to lead 5mm from package body

Dynamic Recovery Characteristics @ $T_J = 25^\circ\text{C}$ (unless otherwise specified)

Parameters	Min	Typ	Max	Units	Test Conditions
t_{rr} Reverse Recovery Time	-	35	60	ns	$I_F = 1.0\text{A}, di_F/dt = 50\text{A}/\mu\text{s}, V_R = 30\text{V}$
	-	43	-		$T_J = 25^\circ\text{C}$
	-	67	-		$T_J = 125^\circ\text{C}$
I_{RRM} Peak Recovery Current	-	2.8	-	A	$T_J = 25^\circ\text{C}$
	-	6.3	-		$T_J = 125^\circ\text{C}$
Q_{rr} Reverse Recovery Charge	-	60	-	nC	$T_J = 25^\circ\text{C}$
	-	210	-		$T_J = 125^\circ\text{C}$

$I_F = 8\text{A}$
 $V_R = 200\text{V}$
 $di_F/dt = 200\text{A}/\mu\text{s}$

Thermal - Mechanical Characteristics

Parameters	Min	Typ	Max	Units
R_{thJC} Thermal Resistance, Junction to Case	-	1.8	2	$^\circ\text{C}/\text{W}$
R_{thJA} ① Thermal Resistance, Junction to Ambient	-	-	50	
R_{thCS} ② Thermal Resistance, Case to Heatsink	-	0.5	-	
W_t Weight	-	2.0	-	g
	-	0.07	-	(oz)
Mounting Torque	6.0	-	12	Kg-cm
	5.0	-	10	lbf.in
Marking Device	8ETU04			

① Typical Socket Mount

② Mounting Surface, Flat, Smooth and Greased

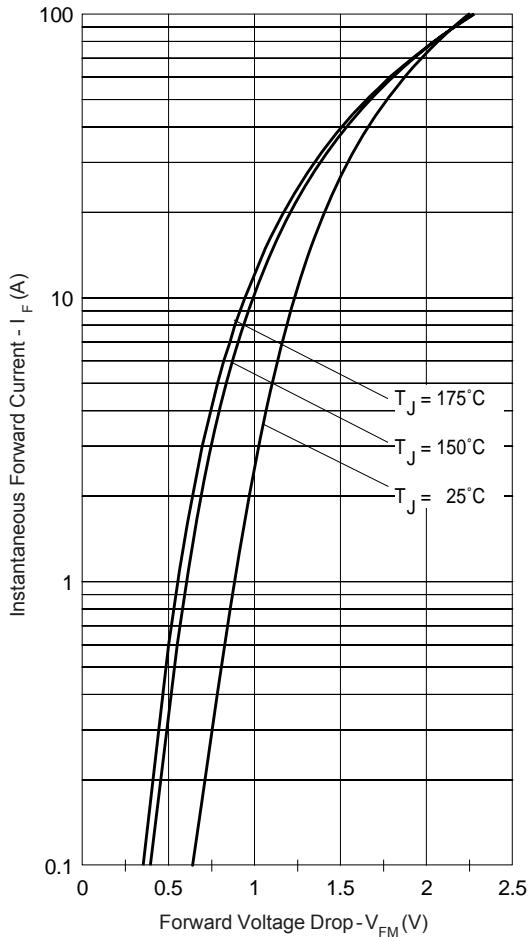

Fig. 1 - Typical Forward Voltage Drop Characteristics

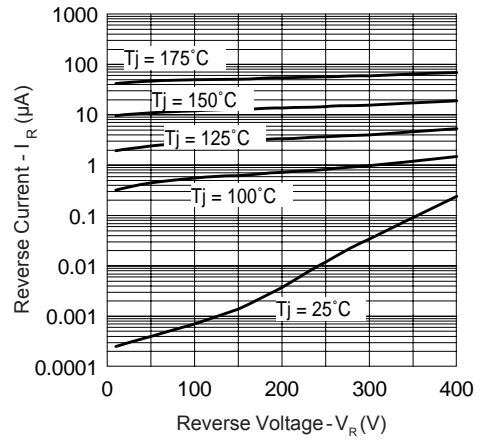

Fig. 2 - Typical Values Of Reverse Current Vs. Reverse Voltage

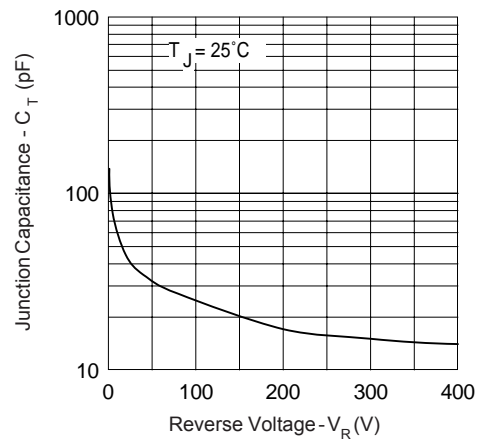

Fig. 3 - Typical Junction Capacitance Vs. Reverse Voltage

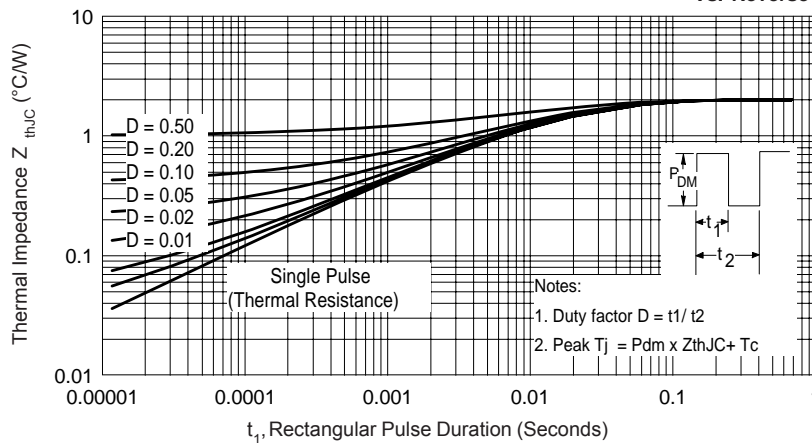

Fig. 4 - Max. Thermal Impedance Z_{thJC} Characteristics

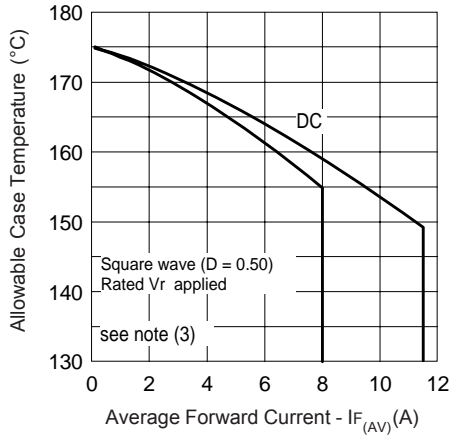

Fig. 5 - Max. Allowable Case Temperature Vs. Average Forward Current

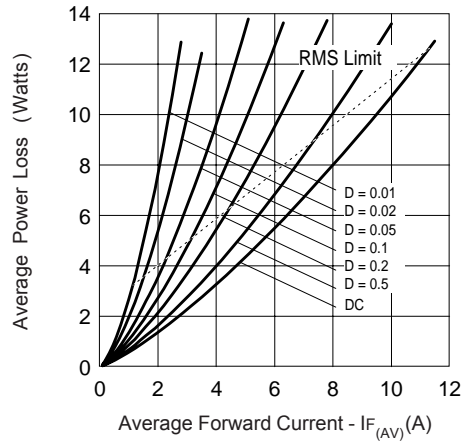

Fig. 6 - Forward Power Loss Characteristics

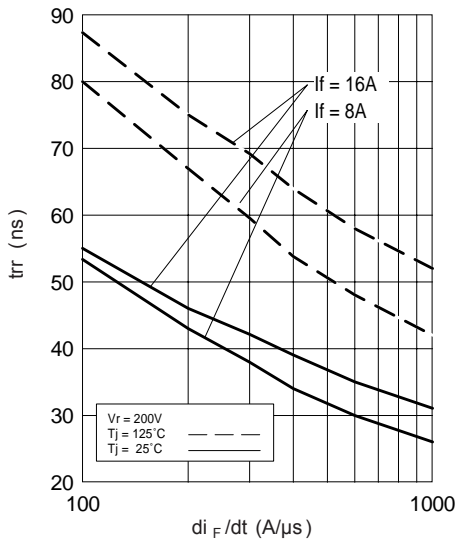

Fig. 7 - Typical Reverse Recovery vs. di_F/dt

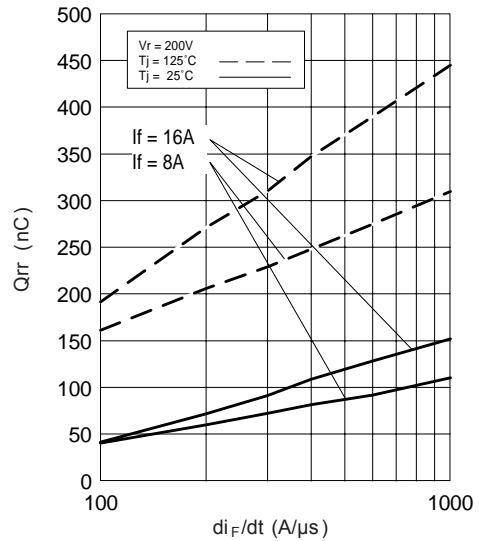

Fig. 8 - Typical Stored Charge vs. di_F/dt

(3) Formula used: $T_c = T_j - (Pd + Pd_{REV}) \times R_{thJC}$;
 $Pd = \text{Forward Power Loss} = I_{F(AV)} \times V_{FM} @ (I_{F(AV)} / D)$ (see Fig. 6);
 $Pd_{REV} = \text{Inverse Power Loss} = V_{R1} \times I_R (1 - D)$; $I_R @ V_{R1} = \text{rated } V_R$

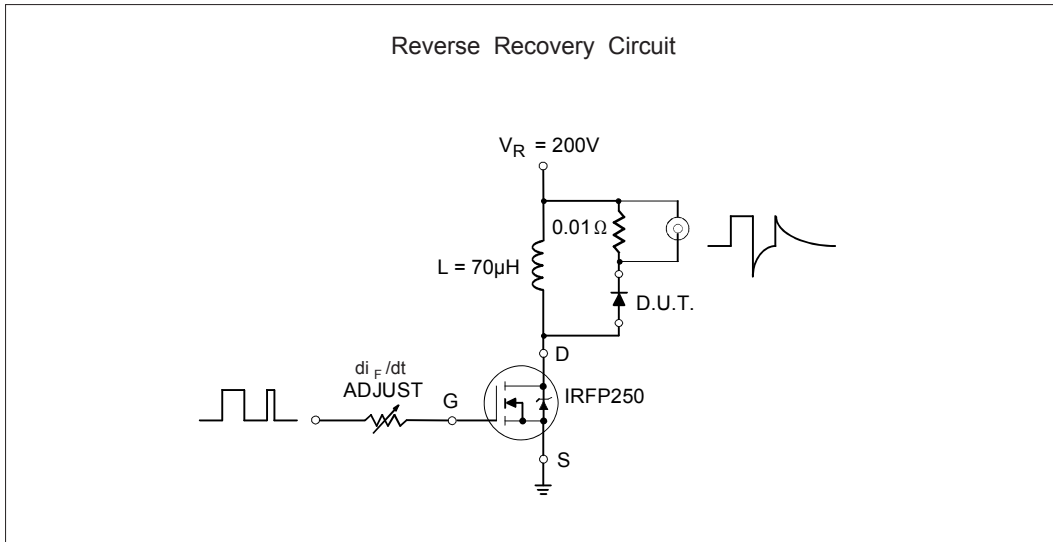

Fig. 9- Reverse Recovery Parameter Test Circuit

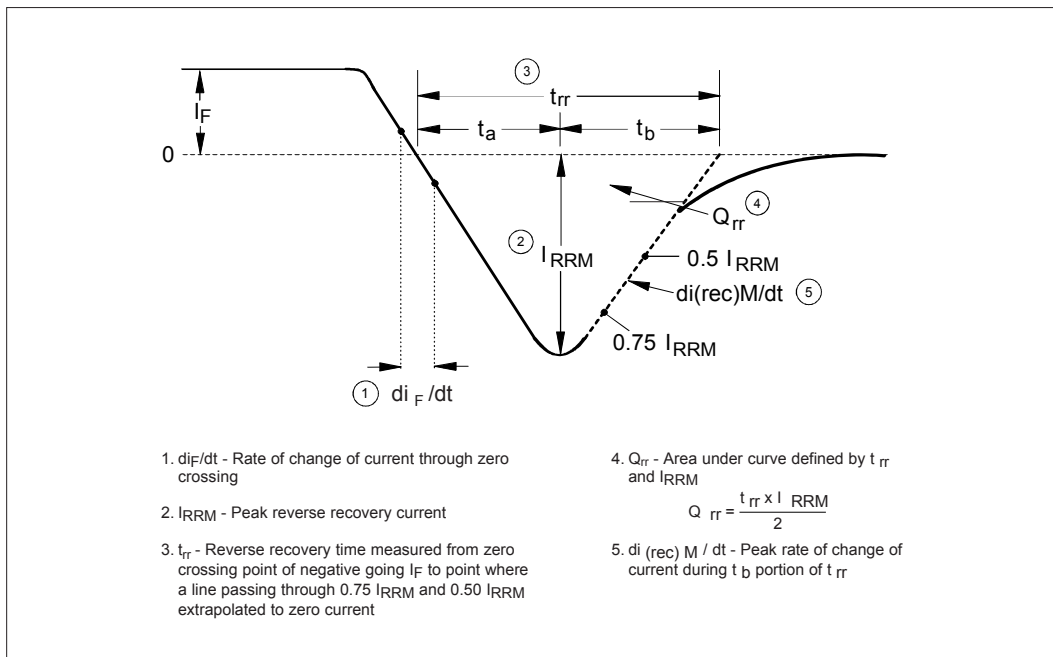
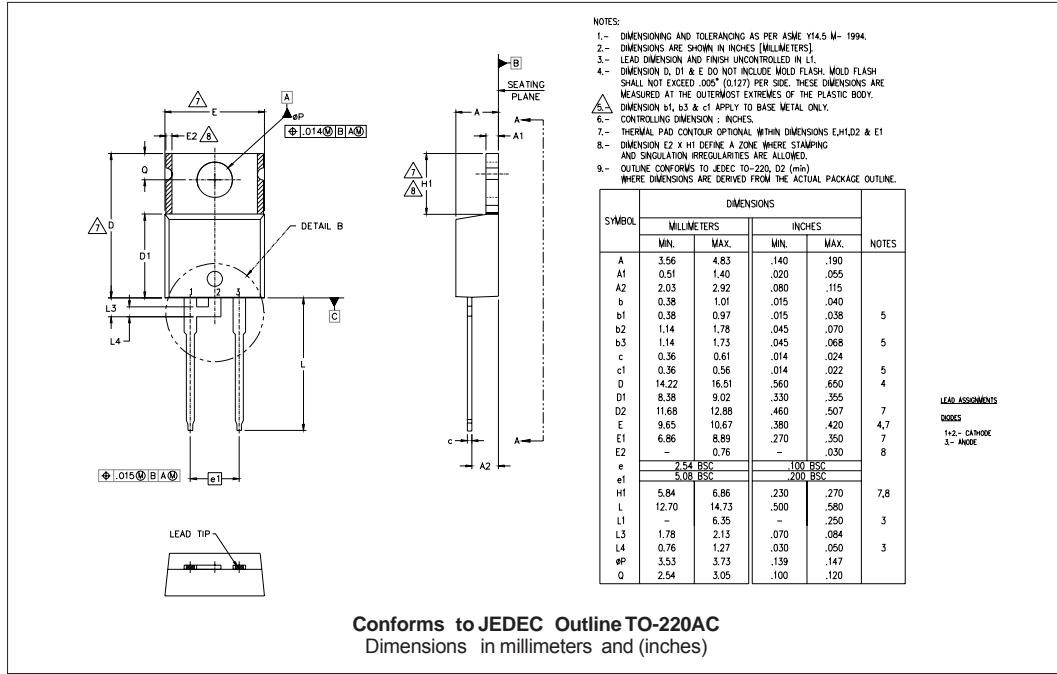
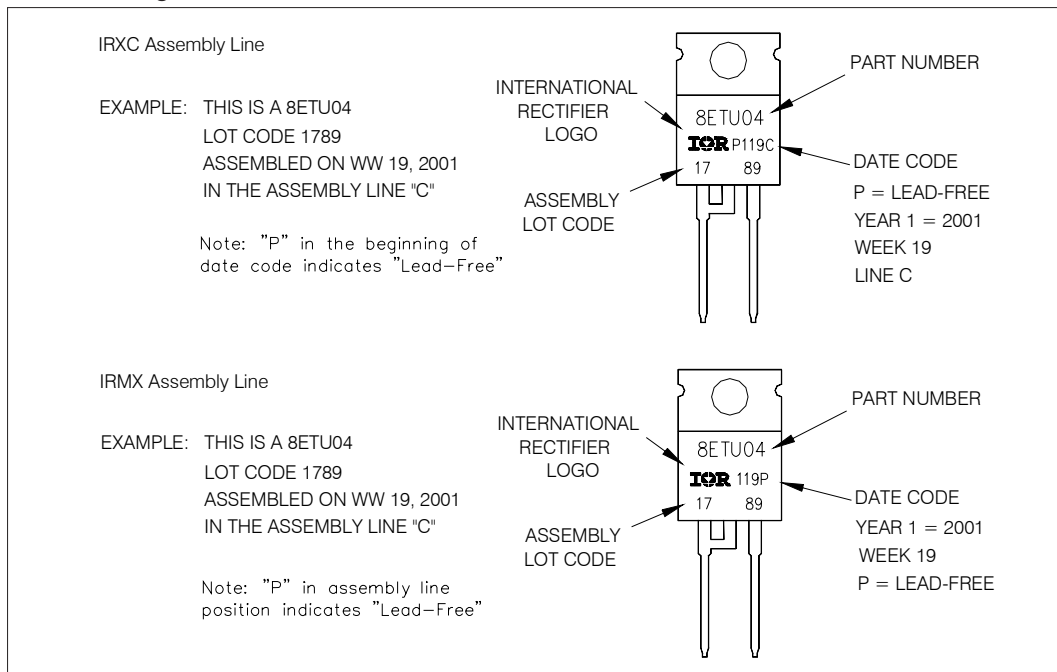

Fig. 10 - Reverse Recovery Waveform and Definitions

Outline Table



Part Marking Information



Ordering Information Table

Device Code													
	<table border="1" style="margin: auto;"> <tr> <td style="padding: 5px;">8</td> <td style="padding: 5px;">E</td> <td style="padding: 5px;">T</td> <td style="padding: 5px;">U</td> <td style="padding: 5px;">04</td> <td style="padding: 5px;">PbF</td> </tr> <tr> <td style="text-align: center;">①</td> <td style="text-align: center;">②</td> <td style="text-align: center;">③</td> <td style="text-align: center;">④</td> <td style="text-align: center;">⑤</td> <td style="text-align: center;">⑥</td> </tr> </table>	8	E	T	U	04	PbF	①	②	③	④	⑤	⑥
8	E	T	U	04	PbF								
①	②	③	④	⑤	⑥								
1	- Current Rating (8 = 8A)												
2	- E = Single Diode												
3	- Package T = TO-220												
4	- U = UltraFast Recovery												
5	- Voltage Rating (04 = 400V)												
6	- <ul style="list-style-type: none"> • none = Standard Production • PbF = Lead-Free 												
<p>Tube Standard Pack Quantity : 50 pieces</p>													

Data and specifications subject to change without notice.
 This product has been designed and qualified for Industrial Level and Lead-Free.
 Qualification Standards can be found on IR's Web site.

8ETU04PbF

Bulletin PD-21078 rev. A 10/06

International
IOR Rectifier

Data and specifications subject to change without notice.
This product has been designed and qualified for Industrial Level.
Qualification Standards can be found on IR's Web site.

International
IOR Rectifier

IR WORLD HEADQUARTERS: 233 Kansas St., El Segundo, California 90245, USA Tel: (310) 252-7105
TAC Fax: (310) 252-7309
Visit us at www.irf.com for sales contact information. 10/06