

International IR Rectifier

8ETX06
8ETX06S
8ETX06-1
8ETX06FP

Hyperfast Rectifier

Features

- Hyperfast Recovery Time
- Low Forward Voltage Drop
- Low Leakage Current
- 175°C Operating Junction Temperature
- UL E78996 approved 

$t_{rr} = 15\text{ns typ.}$
 $I_{F(AV)} = 8\text{Amp}$
 $V_R = 600\text{V}$

Description/ Applications

State of the art Hyperfast recovery rectifiers designed with optimized performance of forward voltage drop, Hyperfast recover time, and soft recovery.

The planar structure and the platinum doped life time control guarantee the best overall performance, ruggedness and reliability characteristics.



These devices are intended for use in PFC Boost stage in the AC-DC section of SMPS, inverters or as freewheeling diodes.

The IR extremely optimized stored charge and low recovery current minimize the switching losses and reduce over dissipation in the switching element and snubbers.

Absolute Maximum Ratings

Parameters	Max	Units
V_{RRM} Peak Repetitive Reverse Voltage	600	V
$I_{F(AV)}$ Average Rectified Forward Current @ $T_C = 143^\circ\text{C}$ @ $T_C = 106^\circ\text{C}$ (FULLPACK)	8	A
I_{FSM} Non Repetitive Peak Surge Current @ $T_J = 25^\circ\text{C}$	110	
I_{FM} Peak Repetitive Forward Current	18	
T_J, T_{STG} Operating Junction and Storage Temperatures	- 65 to 175	$^\circ\text{C}$

Case Styles

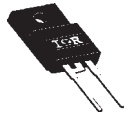
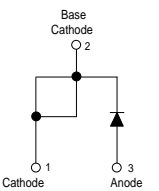
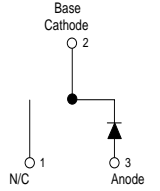
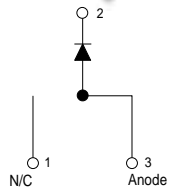
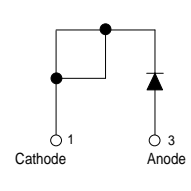
8ETX06	8ETX06S	8ETX06-1	8ETX06FP
			
			
TO-220AC	D ² PAK	TO-262	TO-220 FULLPACK

Electrical Characteristics @ T_J = 25°C (unless otherwise specified)

Parameters	Min	Typ	Max	Units	Test Conditions
V _{BR} , V _F	600	-	-	V	I _R = 100μA
V _F	-	2.3	3.0	V	I _F = 8A, T _J = 25°C
	-	1.4	1.7	V	I _F = 8A, T _J = 150°C
I _R	-	0.3	50	μA	V _R = V _R Rated
	-	35	500	μA	T _J = 150°C, V _R = V _R Rated
C _T	-	17	-	pF	V _R = 600V
L _S	-	8.0	-	nH	Measured lead to lead 5mm from package body

Dynamic Recovery Characteristics @ T_C = 25°C (unless otherwise specified)

Parameters	Min	Typ	Max	Units	Test Conditions	
t _{rr}	-	15	19	ns	I _F = 1A, di _F /dt = 100A/μs, V _R = 30V	
	-	16	24		I _F = 8A, di _F /dt = 100A/μs, V _R = 30V	
	-	17	-		T _J = 25°C	
	-	40	-		T _J = 125°C	
I _R RRM	-	2.3	-	A	T _J = 25°C	
	-	4.5	-		T _J = 125°C	
Q _{rr}	-	20	-	nC	T _J = 25°C	
	-	100	-		T _J = 125°C	
t _{rr}	-	31	-	ns	I _F = 8A di _F /dt = 600A/μs V _R = 390V	
I _R RRM	-	12	-			T _J = 125°C
Q _{rr}	-	195	-			nC

Thermal - Mechanical Characteristics

Parameters	Min	Typ	Max	Units
T _J	-	-	175	°C
T _{Stg}	- 65	-	175	°C
R _{thJC}	-	1.4	2	°C/W
	-	3.4	4.3	
R _{thJA} ①	-	-	70	°C/W
R _{thCS} ②	-	0.5	-	°C/W
Weight	-	2.0	-	g
	-	0.07	-	(oz)
Mounting Torque	6.0	-	12	Kg-cm
	5.0	-	10	lbf.in

① Typical Socket Mount

② Mounting Surface, Flat, Smooth and Greased

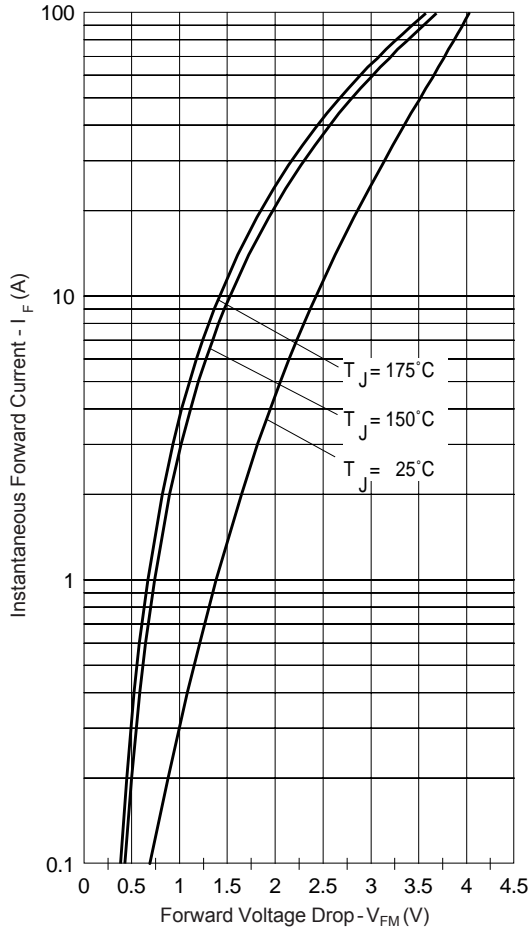

Fig. 1 - Typical Forward Voltage Drop Characteristics

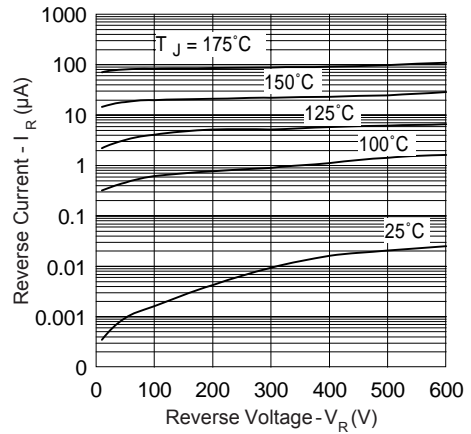

Fig. 2 - Typical Values Of Reverse Current Vs. Reverse Voltage

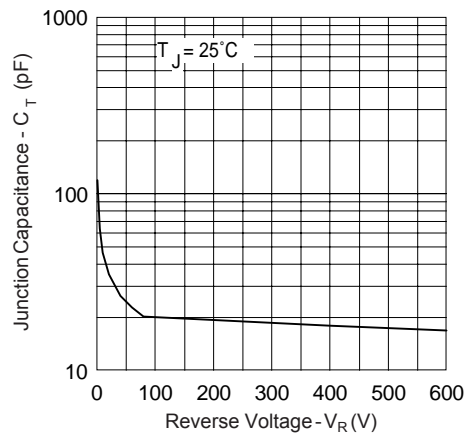

Fig. 3 - Typical Junction Capacitance Vs. Reverse Voltage

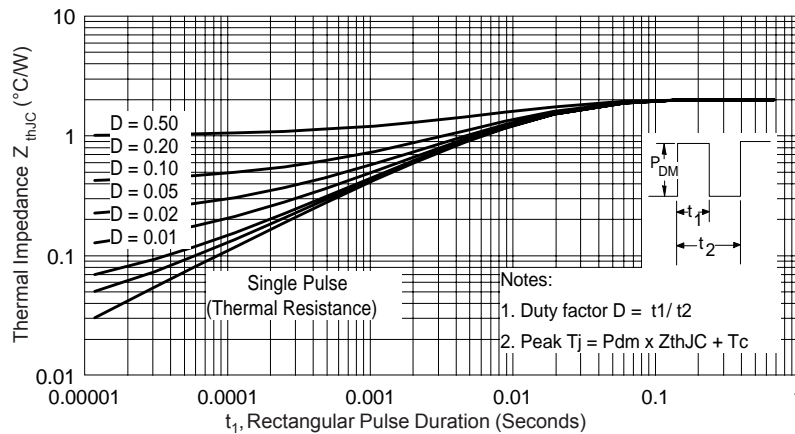

Fig. 4 - Max. Thermal Impedance Z_{thJC} Characteristics

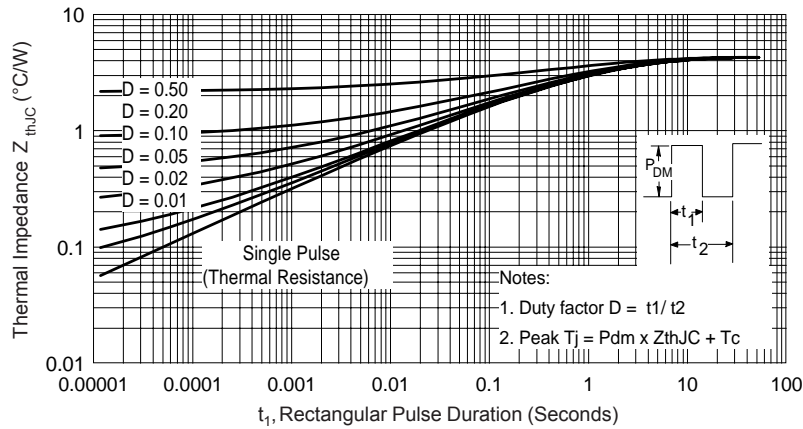

Fig. 5 - Max. Thermal Impedance Z_{thJC} Characteristics (FULLPACK)

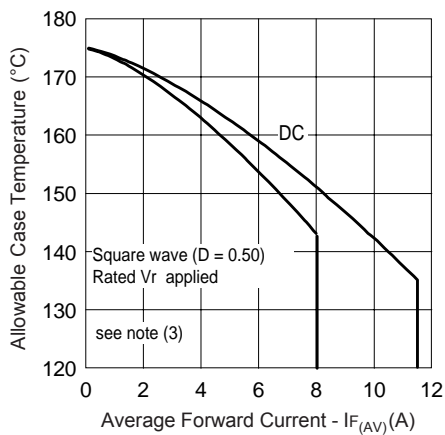

Fig. 6 - Max. Allowable Case Temperature Vs. Average Forward Current

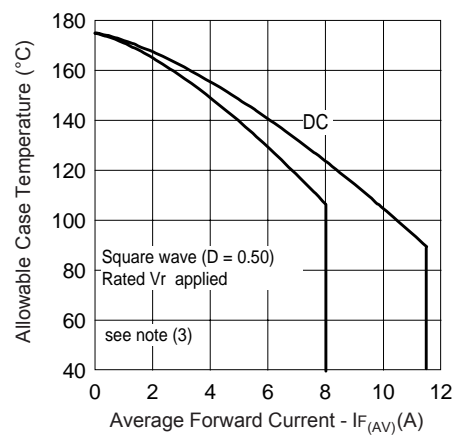

Fig. 7 - Max. Allowable Case Temperature Vs. Average Forward Current (FULLPACK)

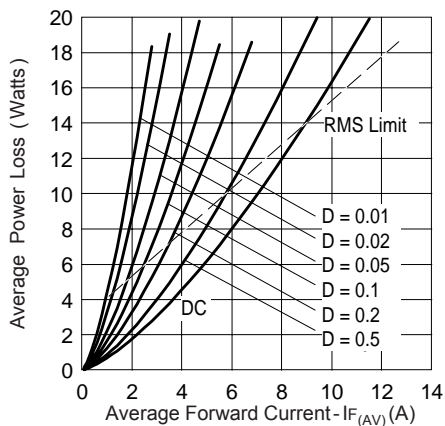

Fig. 8 - Forward Power Loss Characteristics

(3) Formula used: $T_c = T_j - (P_d + P_{d_{REV}}) \times R_{thJC}$;
 P_d = Forward Power Loss =
 $I_{F(AV)} \times V_{FM} @ (I_{F(AV)}/D)$
 (see Fig. 8);
 $P_{d_{REV}}$ = Inverse Power Loss = $V_{R1} \times I_R (1 - D)$;
 $I_R @ V_{R1}$ = rated V_R

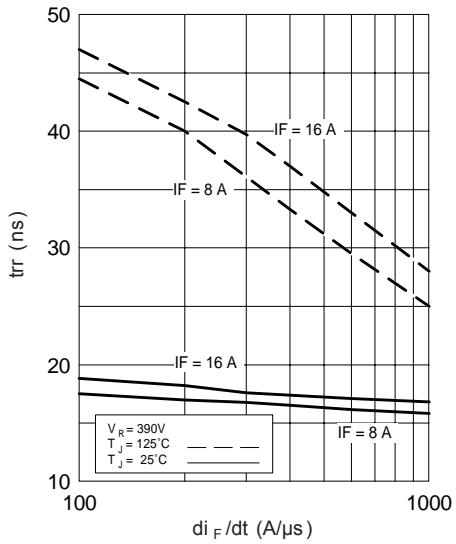

Fig.9 - Typical Reverse Recovery vs. di_F/dt

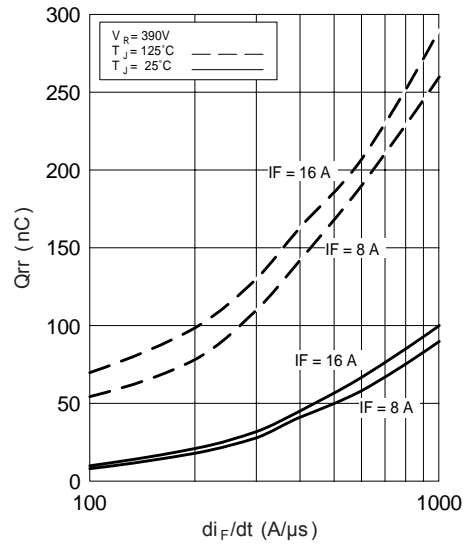

Fig.10 - Typical Stored Charge vs. di_F/dt

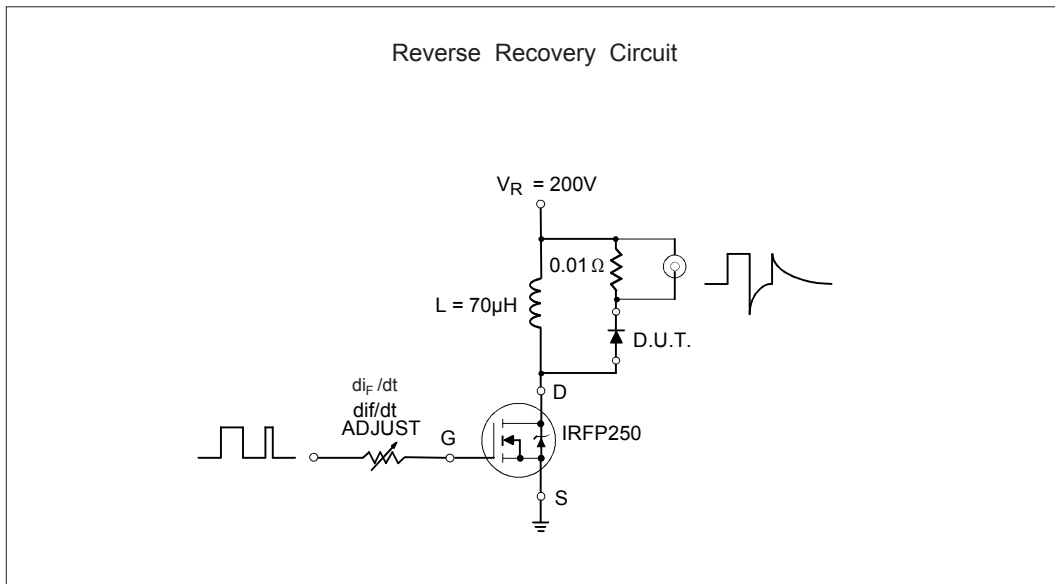

Fig.11 - Reverse Recovery Parameter Test Circuit

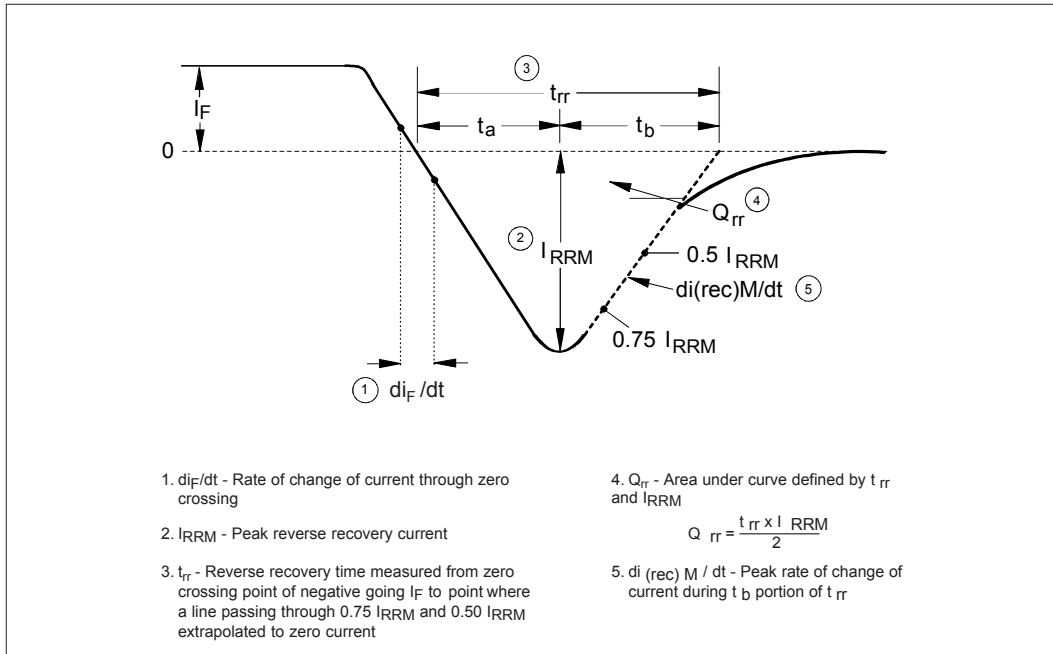
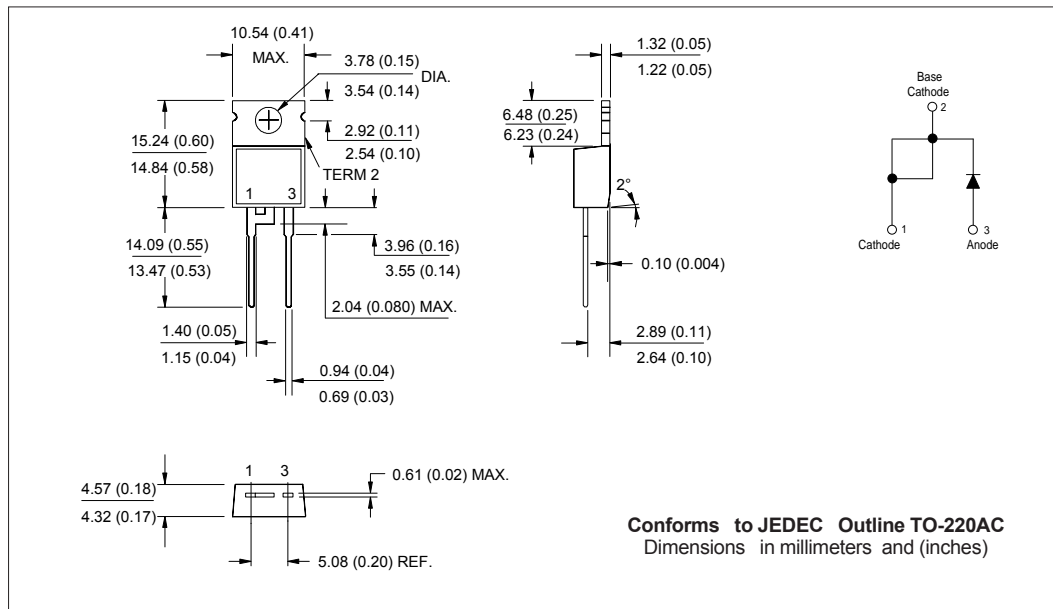
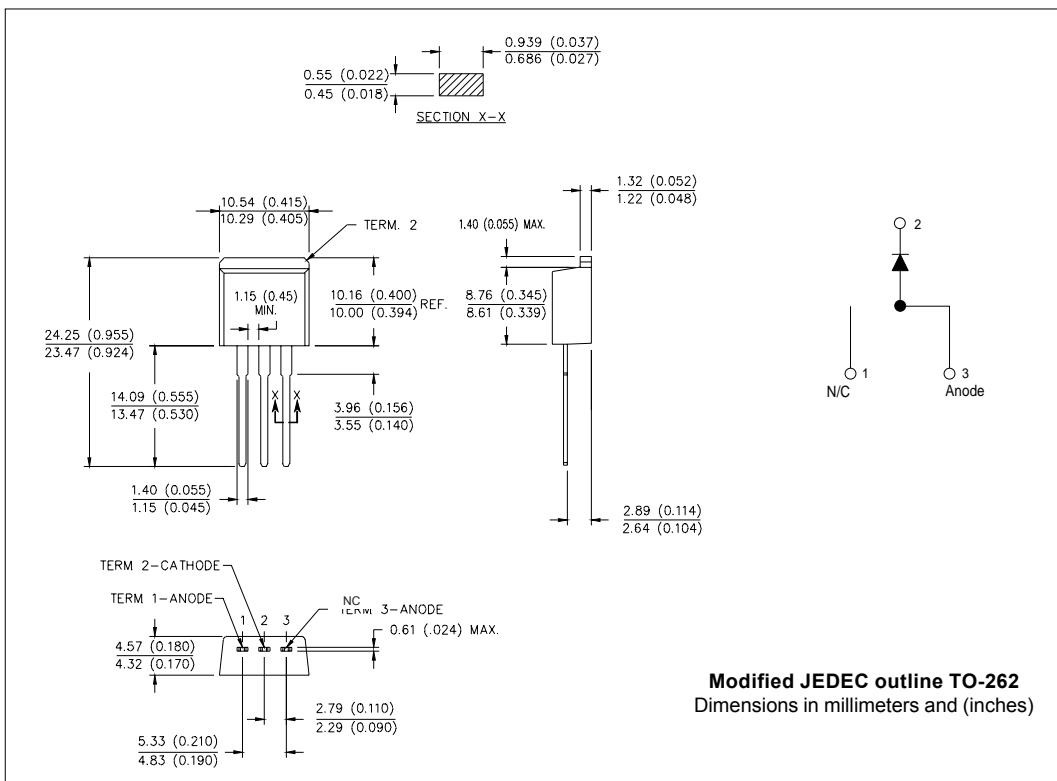
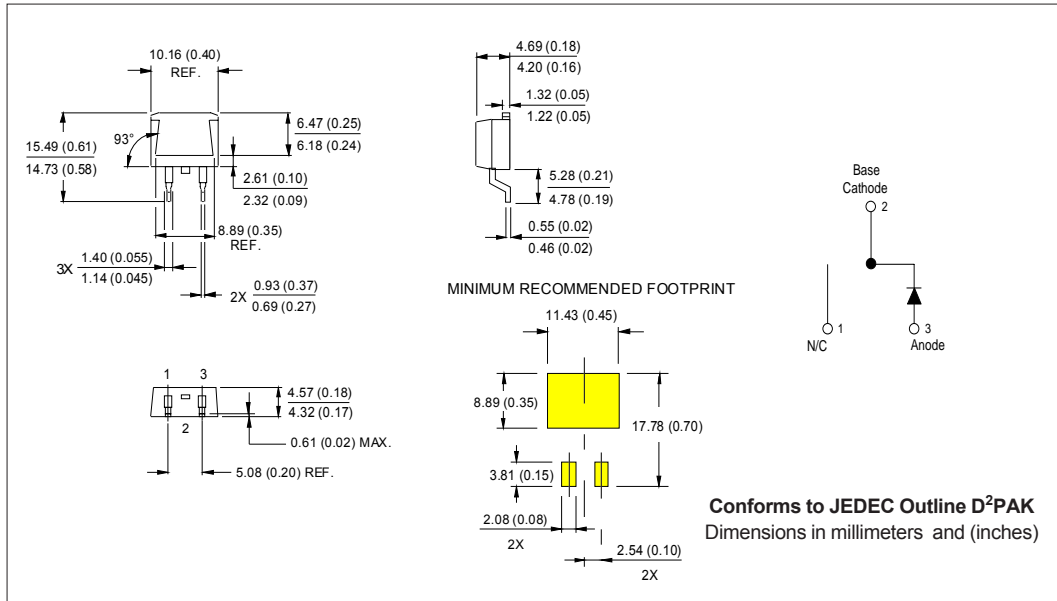

Fig. 12 - Reverse Recovery Waveform and Definitions

Outline Table



Outline Table



Outline Table

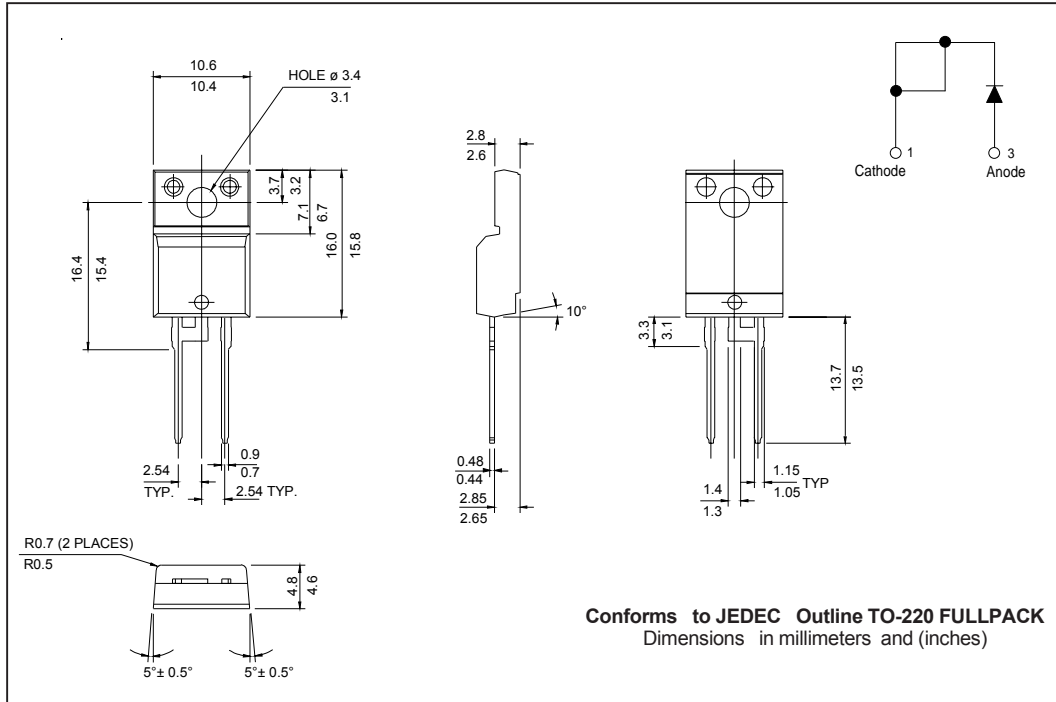

Ordering Information Table

Device Code					
8	E	T	X	06	- 1
①	②	③	④	⑤	⑥
1	- Current Rating (8 = 8A)				
2	- E = Single Diode				
3	- T = TO-220, D ² Pak				
4	- X = HyperFast Recovery				
5	- Voltage Rating (06 = 600V)				
6	- "-1" = TO-262 Option				
	S = D ² Pak				
	None = TO-220AC				
	FP = TO-220 FULLPACK				

Data and specifications subject to change without notice.
This product has been designed and qualified for Industrial Level.
Qualification Standards can be found on IR's Web site.

International
IOR Rectifier

IR WORLD HEADQUARTERS: 233 Kansas St., El Segundo, California 90245, USA Tel: (310) 252-7105
TAC Fax: (310) 252-7309
Visit us at www.irf.com for sales contact information. 02/04