

RoHS Compliant Product
A suffix of "-C" specifies halogen free

DESCRIPTION

The SSG9435BDY provide the designer with the best combination of fast switching, ruggedized device design, low on-resistance and cost-effectiveness. The SOP-8 package is universally preferred for all commercial-industrial surface mount applications and suited for low voltage applications such as DC/DC converters.

FEATURES

- Simple Drive Requirement
- Lower On-resistance
- Fast Switching

MARKING

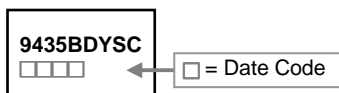

PACKAGE INFORMATION

Package	MPQ	Leader Size
SOP-8	3K	13 inch

SOP-8

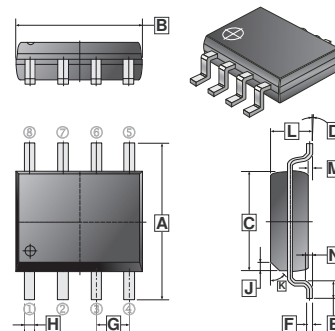

REF.	Millimeter		REF.	Millimeter	
	Min.	Max.		Min.	Max.
A	5.80	6.20	H	0.35	0.49
B	4.80	5.00	J	0.375	REF.
C	3.80	4.00	K	45°	
D	0°	8°	L	1.35	1.75
E	0.40	0.90	M	0.10	0.25
F	0.19	0.25	N	0.25	REF.
G	1.27	TYP.			

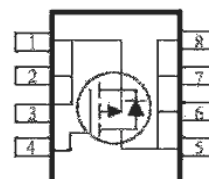

MAXIMUM RATINGS ($T_A = 25^\circ\text{C}$ unless otherwise specified)

Parameter	Symbol	Ratings	Unit	
Drain-Source Voltage	V_{DS}	-30	V	
Gate-Source Voltage	V_{GS}	± 20	V	
Continuous Drain Current ¹	I_D	$T_A = 25^\circ\text{C}$	-5.3	A
		$T_A = 70^\circ\text{C}$	-4.7	A
Pulsed Drain Current ²	I_{DM}	-20	A	
Total Power Dissipation ¹	P_D	2.5	W	
Linear Derating Factor		0.02	W / $^\circ\text{C}$	
Operating Junction & Storage temperature	T_J, T_{STG}	-55~150	$^\circ\text{C}$	
Thermal Resistance Ratings				
Thermal Resistance Junction-ambient ¹ (Max.)	$R_{\theta JA}$	50	$^\circ\text{C} / \text{W}$	

ELECTRICAL CHARACTERISTICS ($T_A = 25^\circ\text{C}$ unless otherwise specified)

Parameter	Symbol	Min.	Typ.	Max.	Unit	Test Conditions
Static						
Drain-Source Breakdown Voltage	BV_{DSS}	-30	-	-	V	$V_{GS}=0, I_D = -250\mu\text{A}$
Gate Threshold Voltage	$V_{GS(th)}$	-1.0	-	-2.5	V	$V_{DS}=V_{GS}, I_D = -250\mu\text{A}$
Forward Transconductance ²	g_{fs}	-	5	-	S	$V_{DS} = -5\text{V}, I_D = -5.3\text{A}$
Gate-Source Leakage Current	I_{GSS}	-	-	± 100	nA	$V_{GS} = \pm 20\text{V}$
Drain-Source Leakage Current	I_{DSS}	-	-	-1	μA	$V_{DS} = -30\text{V}, V_{GS} = 0$
Static Drain-Source On-Resistance ²	$R_{DS(ON)}$	-	-	36	m Ω	$V_{GS} = -10\text{V}, I_D = -5.3\text{A}$
		-	-	55		$V_{GS} = -4.5\text{V}, I_D = -4.2\text{A}$
Total Gate Charge ²	Q_g	-	9.8	-	nC	$I_D = -6\text{A}$ $V_{DS} = -20\text{V}$ $V_{GS} = -4.5\text{V}$
Gate-Source Charge	Q_{gs}	-	2.2	-		
Gate-Drain("Miller") Charge	Q_{gd}	-	3.4	-		
Turn-On Delay Time ²	$T_{d(ON)}$	-	16.4	-	nS	$V_{DS} = -24\text{V}$ $I_D = -1\text{A}$ $V_{GS} = -10\text{V}$ $R_G = 3.3\Omega$
Rise Time	T_r	-	20.2	-		
Turn-off Delay Time	$T_{d(OFF)}$	-	55	-		
Fall Time	T_f	-	10	-		
Input Capacitance	C_{iss}	-	930	-	pF	$V_{GS} = 0$ $V_{DS} = -15\text{V}$ $f = 1.0\text{MHz}$
Output Capacitance	C_{oss}	-	148	-		
Reverse Transfer Capacitance	C_{rss}	-	115	-		
Source -Drain Diode						
Forward On Voltage ²	V_{SD}	-	-0.84	-1.2	V	$I_S = -1.7\text{A}, V_{GS} = 0\text{V}$

Note:

- Surface mounted on 1 in² copper pad of FR4 board; 125°C/W when mounted on min. copper pad.
- Pulse width limited by Max. junction temperature.

CHARACTERISTICS CURVE

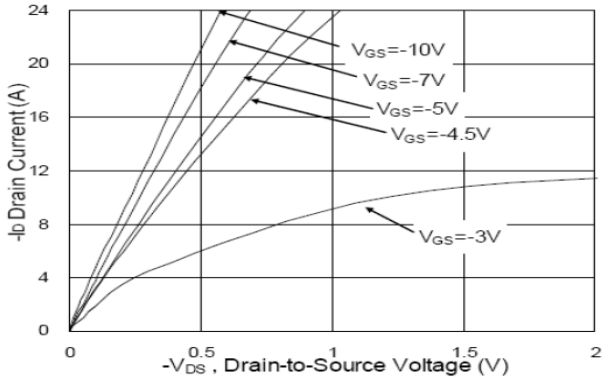

Fig 1. Typical Output Characteristics

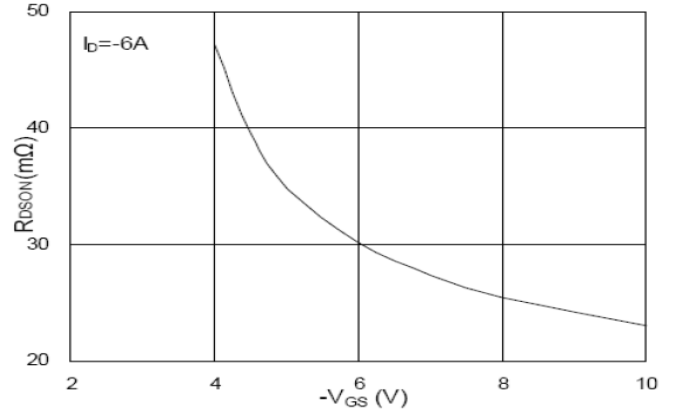

Fig 2. On-Resistance v.s. Gate Voltage

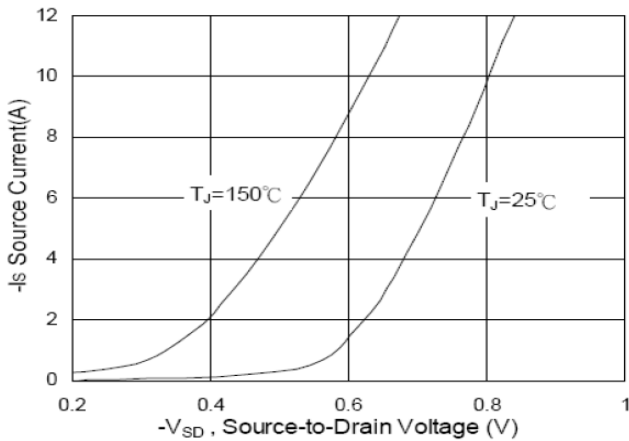

Fig 3. Body Diode Forward Voltage v.s. Source Current

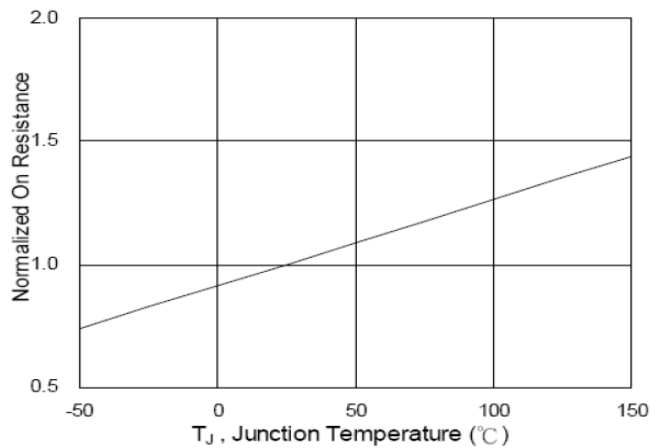

Fig 4. On-Resistance v.s. Junction Temperature

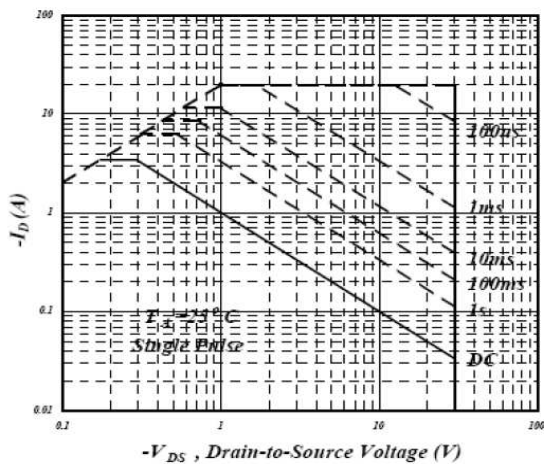

Fig 5. Maximum Safe Operating Area

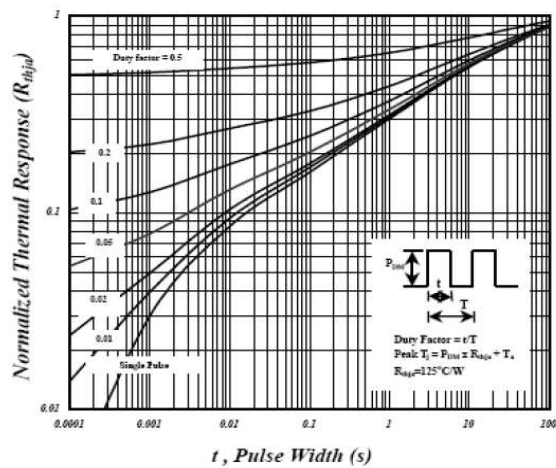

Fig 6. Normalized Thermal Transient Impedance Curve

CHARACTERISTICS CURVE

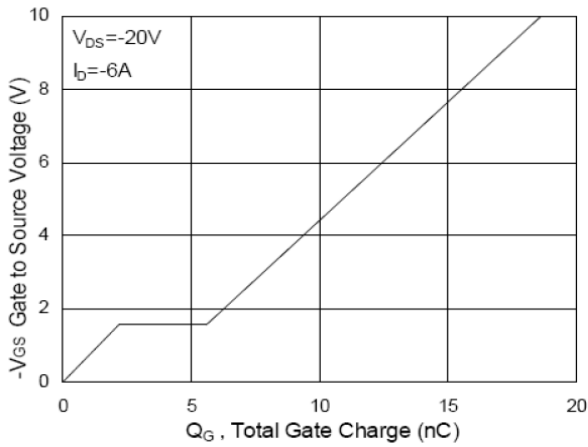

Fig 7. Gate Charge Characteristics

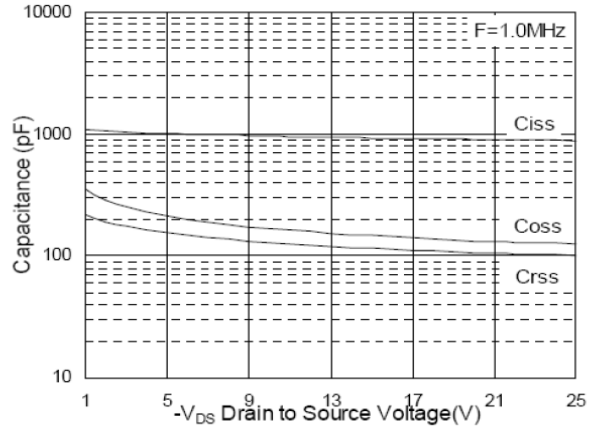

Fig 8. Typical Capacitance Characteristics

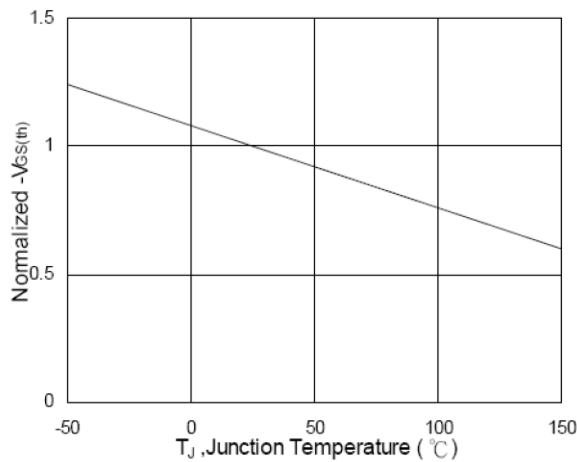

Fig 9. Gate Threshold Voltage v.s. Junction Temperature

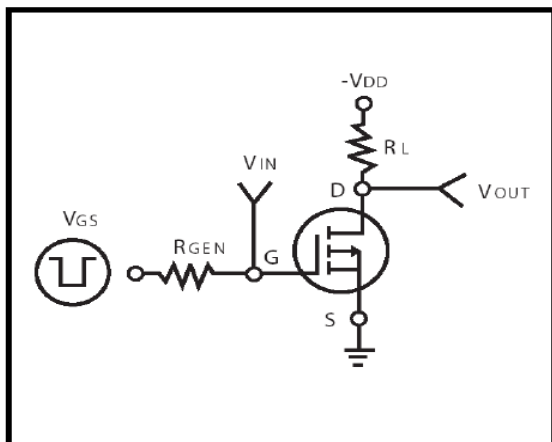

Fig 10. Switching Time Circuit

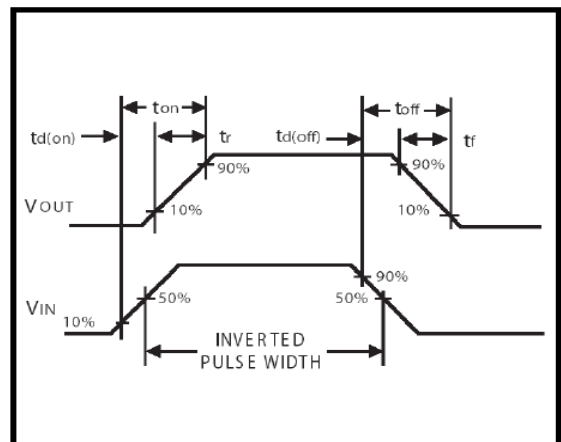

Fig 11. Switching Time Waveform