



CUSTOMER APPROVAL SHEET

Company Name	
MODEL	A050FTT04.0
CUSTOMER APPROVED	Title : Name :

- APPROVAL FOR SPECIFICATIONS ONLY (Spec. Ver. 0.3)
- APPROVAL FOR SPECIFICATIONS AND ES SAMPLE (Spec. Ver. 0.3)
- APPROVAL FOR SPECIFICATIONS AND CS SAMPLE (Spec. Ver. 0.3)
- CUSTOMER REMARK :

P/N : 97.05A21.000

Comment :

**1 Li-Hsin Rd. 2. Science-Based Industrial Park
Hsinchu 300, Taiwan, R.O.C.
Tel: +886-3-500-8899
Fas: +886-3-577-2730**



Doc. version :	0.3
Total pages :	33
Date :	2014/03/11

Product Specification

5" COLOR TFT-LCD MODULE/PANEL

MODEL NAME: A050FTT04.0

Planned Lifetime: From 2013/Jul To 2015/Dec

Phase-out Control: From 2015/Jul To 2015/Dec

EOL Schedule: 2015/Dec

< ◆ >Preliminary Specification

< >Final Specification

Note: The content of this specification is subject to change.

© 2012 AU Optronics
All Rights Reserved,
Do Not Copy.



Record of Revision

Version	Revise Date	Page	Content
0.0	2013.07.05		First Draft
0.1	2013.07.10	5	Update overall dimension
0.1	2013.07.10	6	Update outline dimension of Drawing due to using 0.215t SGLC bezel
0.2	2014.01.20	6, 25, 26	Update module drawing, Update Linearity test force to be 150g , Update operation force to be 50g Max.
0.3	2014.03.11	6	Update the material name of SGLC bezel in the drawing.

Contents

A. General Information	5
B. Outline Dimension	6
1. TFT-LCD Module – Front and Rear View	6
C. Electrical Specifications	7
1. TFT LCD Panel Pin Assignment	7
2. Absolute Maximum Ratings	9
3. Electrical DC Characteristics	9
4. Electrical AC Characteristics	11
b. Serial port interface AC characteristics	12
5. Serial Interface Characteristics	13
5. Power On/Off Characteristics	20
D. Optical Specification	22
E. Touch Screen Panel Specifications	25
1. FPC Pin Assignment	25
2. Electrical Characteristics	25
3. Mechanical Characteristics	26
4. Life Test Condition	26
5. Attention	27
F. Reliability Test Items	28
G. Packing and Marking	30
1. Packing Form	30
2. Module/Panel Label Information	31
H. Application Note	32
1. Application Circuit	32
I. Precautions	33

A. General Information

This product is for portable PND and digital photo frame application.

NO.	Item	Unit	Specification	Remark
1	Screen Size	inch	5.0(Diagonal)	
2	Display Resolution	dot	480RGB (H) X 272 (V)	
3	Overall Dimension	mm	120.73(H) X 75.83(V) X 4.265(T)	Note 1
4	Active Area	mm	110.88 (H) X 62.832 (V)	
5	Pixel Pitch	mm	0.231 (H) X 0.231 (V)	
6	Color Configuration	--	R. G. B. Stripe	Note 2
7	Color Depth	--	262k Colors	Note 3
8	NTSC Ratio (Cell)	%	50	
9	Display Mode	--	Normally White	
10	Panel surface Treatment	--	Anti-Glare, 3H	
11	Weight	g	75	
12	Power Consumption	mW	< 900	Note 4
13	Viewing direction		6 o'clock (gray inversion)	

Note 1: Not include backlight cable and FPC. Refer next page to get further information.

Note 2: Below figure shows dot stripe arrangement.

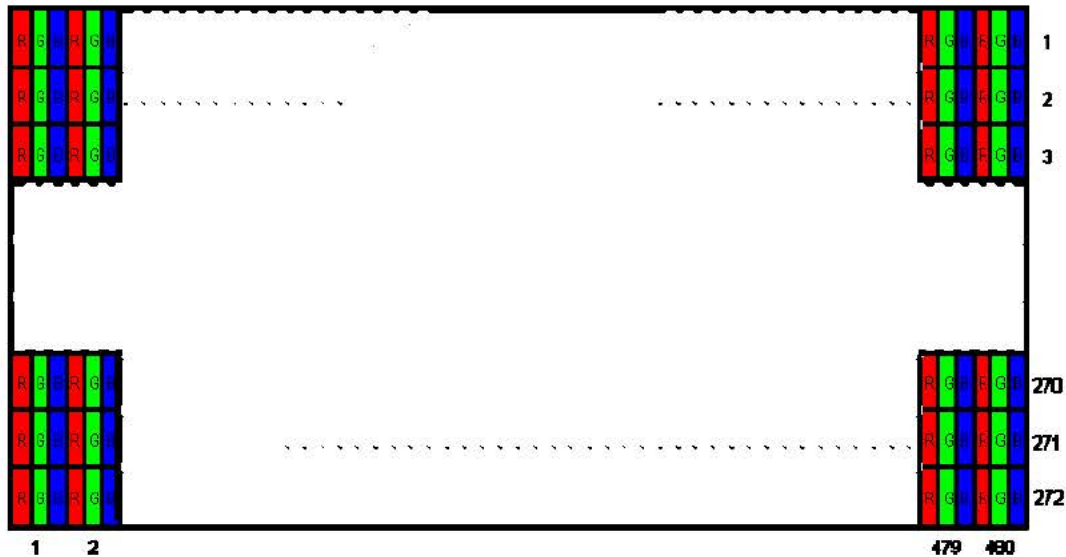

Note 3: The full color display depends on 18-bit data signal.

Note 4: Please refer to Electrical Characteristics chapter.

∴ ∴

B. Outline Dimension

1. TFT-LCD Module – Front and Rear View

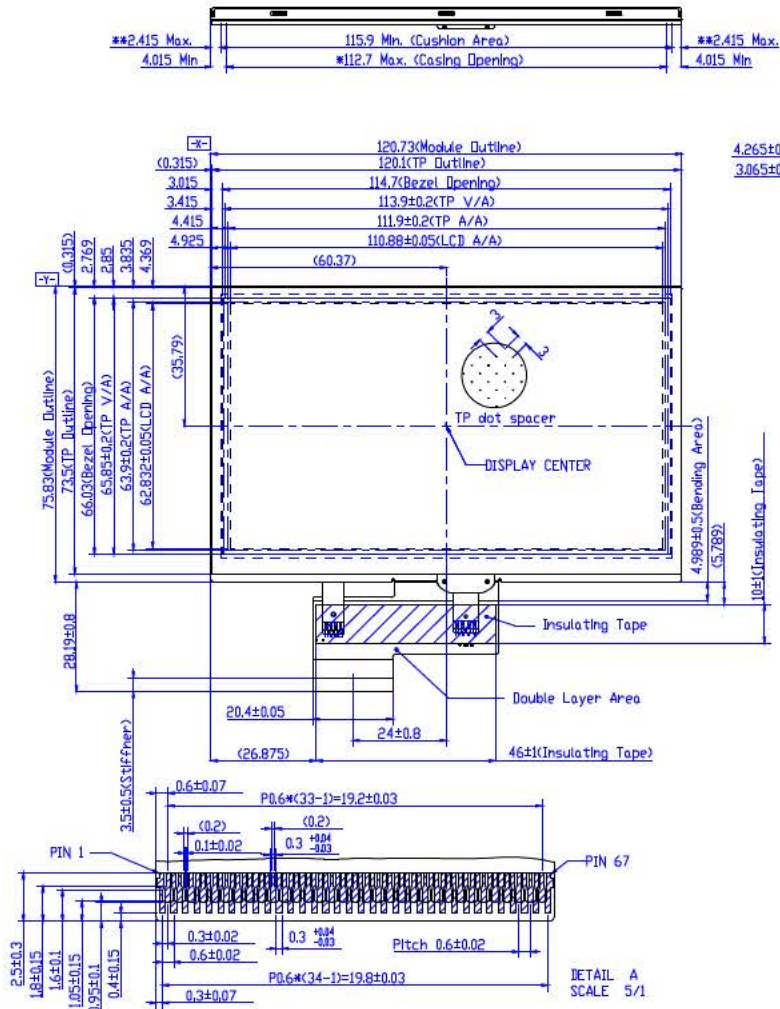

- Notes:
 1. General tolerance $\pm 0.2mm$.
 2. The bending radius of FPC should be larger than 0.6.
 3. * It means the case open should not be larger than this area.
 ** Suggested gasket (cushion) area

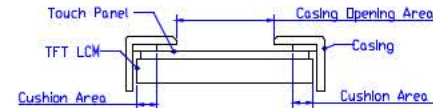

4. The dimensions in brackets () are for reference.
 5. This Module is finger use only.

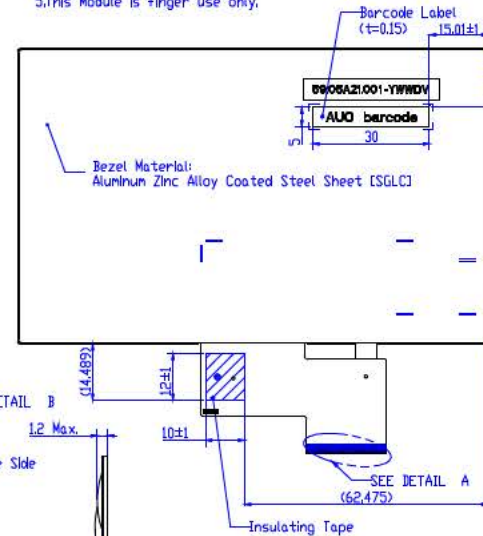

DETAIL B
SCALE 5/1

C. Electrical Specifications

1. TFT LCD Panel Pin Assignment

Recommended connector : FH26G-67S-0.3SHBW(6)

No.	Pin Name	I/O	Description	Remarks
1	VLED-	P	Power for LED backlight cathode	
2	VLED+	P	Power for LED backlight anode	
3	DGND	P	Grounding for digital circuit	
4	X1	I/O	Touch Panel Right Electrode	
5	Y2	I/O	Touch Panel Bottom Electrode	
6	X2	I/O	Touch Panel Left Electrode	
7	Y1	I/O	Touch Panel Top Electrode	
8	AGND	P	Grounding for analog circuit	
9	VGH	C	Stabilizing capacitor	
10	C1P	C	Booster capacitor	
11	C1M	C	Booster capacitor	
12	C2P	C	Booster capacitor	
13	C2M	C	Booster capacitor	
14	NC	-		
15	C3P	C	Booster capacitor	
16	C3M	C	Booster capacitor	
17	AGND	P	Grounding for analog circuit	
18	NC	-		
19	C4P	C	Booster capacitor	
20	C4M	C	Booster capacitor	
21	AVDD	P	Analog and Charge Pump Supply Voltage input pin for booster circuit (3.3V)+(4.7uF/6.3V)	
22	ID2	I/O	GND	
23	AGND	P	Grounding for analog circuit	
24	VCC	C	Stabilizing capacitor	
25	C9P	C	Booster capacitor	
26	C9M	C	Booster capacitor	
27	ID1	I/O	Connect to PGND on FPC	
28	GRB	I	System reset pin(active low)	
29	PGND	P	Grounding for booster circuit	
30	DVDD	P	Digital interface Supple Voltageinput (1.8V/3.3V)+(2.2uF/6.3V)	
31	VDDA	C	Stabilizing capacitor	
32	PGND	P	Grounding for booster circuit	
33	DISP	I	Standby control signal	

No.	Pin Name	I/O	Description	Remarks
34	CSB	I	Chip select pin of serial interface	
35	SDA	I	Data input pin in serial mode	
36	SCL	I	Clock input in serial mode	
37	VGL	C	Stabilizing capacitor	
38	DEN	I	Display enable pin from controller	
39	B7	I	Blue data	
40	B6	I	Blue data	
41	B5	I	Blue data	
42	B4	I	Blue data	
43	B3	I	Blue data	
44	B2	I	Blue data	
45	G7	I	Green data	
46	G6	I	Green data	
47	G5	I	Green data	
48	G4	I	Green data	
49	G3	I	Green data	
50	G2	I	Green data	
51	R7	I	Red data	
52	R6	I	Red data	
53	R5	I	Red data	
54	R4	I	Red data	
55	R3	I	Red data	
56	R2	I	Red data	
57	NC	-	No connection	
58	NC	-	No connection	
59	CLK	I	Dot-clock and oscillator source	
60	COMVSS	C	Stabilizing capacitor	
61	PGND	P	Grounding for booster circuit	
62	VSSA	C	Stabilizing capacitor	
63	VSSA	C	Stabilizing capacitor	
64	VCOM	C	Stabilizing capacitor	
65	DGND	P	Grounding for digital circuit	
66	C7P	C	Booster capacitor	
67	C7M	C	Booster capacitor	

I: Digital signal input, O: Digital signal output, G: GND, PI: Power input, C: Capacitor

Note: For detail information, please check application circuit in Page 29/32

2. Absolute Maximum Ratings

Items	Symbol	Values		Unit	Condition
		Min.	Max.		
Power Supply Voltage	VDD	-0.3	6	V	
Interface Supply Voltage	VDDIO	-0.3	6	V	
LED Reverse Voltage	V_r		5	V	One LED
LED Forward Voltage	V_f	3		V	One LED
LED Forward Current	I_f	--	25	mA	One LED
Operation Temperature	T_{op}	-20	70	°C	
Storage Temperature	T_{st}	-30	80	°C	

Note 1: Functional operation should be restricted under ambient temperature (25°C).

Note2: Maximum ratings are those values beyond which damages to the device may occur. Functional operation should be restricted to the limits in the Electrical Characteristics chapter.

3. Electrical DC Characteristics

a. Typical Operation Condition (GND = 0V)

Item		Symbol	Min.	Typ.	Max.	Unit	Remark
Power Voltage		VDDIO	1.65	--	VDD	V	Digital Power Supply
		VDD	3.0	3.3	3.6	V	Analog Power Supply
Input Signal Voltage	H Level	V_{IH}	$0.7 \times V_{DDIO}$	--	VDDIO	V	
	L Level	V_{IL}	GND	--	$0.3 \times V_{DDIO}$	V	

b. Current Consumption (GND=0V)

Parameter	Symbol	Condition	Min.	Typ.	Max.	Unit	Remark
Input Current for VDD	I_{VDD}	VDD=3.3V	-	21	28	mA	Note 1, 2
	I_{VDD} (STANDBY)	VDD=3.3V	-	12	15	uA	Note 3
Input Current for VDDIO	I_{VDDIO}	VDDIO=3.3V	-	20	40	uA	Note 1, 2
	I_{VDDIO} (STANDBY)	VDDIO=3.3V	-	35	40	uA	Note 3

Note 1: Test Condition is under typical Electrical DC and AC characteristics.

Note 2: Test pattern is the following picture.

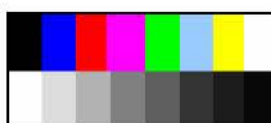

Note 3: In standby mode, all digital signals are stopped. Ex. DCLK, DE ..etc.

c. Backlight Driving Conditions

The backlight (LED module, Note 1) is suggested to drive by constant current with typical value.

Parameter	Symbol	Min.	Typ.	Max.	Unit	Remark
LED Current	I_L	--	20	22	mA	Note 1
Power Consumption	P_L	--	744	897.6	mW	
LED Life Time	L_L	10,000	--	--	Hr	Note 2, 3

Note 1: LED backlight is two parallel strings and one LED for each string is as below figure. Suggest to drive by 20mA for each LED string.

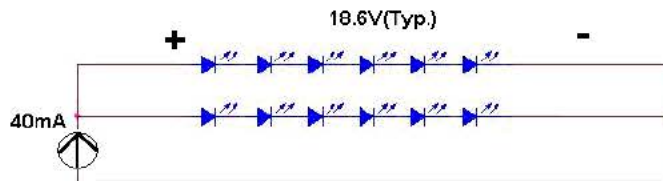

Note 2: Define "LED Lifetime": brightness is decreased to 50% of the initial value. LED Lifetime is restricted under normal condition, ambient temperature = 25°C and LED lightbar current = 20mA.

Note 3: If it uses larger LED lightbar voltage/ current more than 20mA, it maybe decreases the LED lifetime.

4. Electrical AC Characteristics

a. Signal AC Characteristics

Parameter	Symbol	Min.	Typ.	Max.	Unit	Remark
DCLK duty cycle	D_{cw}	40	50	60	%	$t_{cw} / t_{DCLK} \times 100\%$
CLK pulse duty	t_{cw}	40	--	--	ns	
Data Setup Time	t_{dst}	6	--	--	ns	
Data Hold Time	t_{dhhd}	6	--	--	ns	
DE Setup Time	t_{dest}	6	--	--	ns	
DE Hold Time	t_{dehd}	6	--	--	ns	
Vsync Setup Time	t_{vst}	6	--	--	ns	
Vsync Hold Time	t_{vhhd}	6	--	--	ns	
Hsync Setup Time	t_{hst}	6	--	--	ns	
Hsync Hold Time	t_{hhd}	6	--	--	ns	

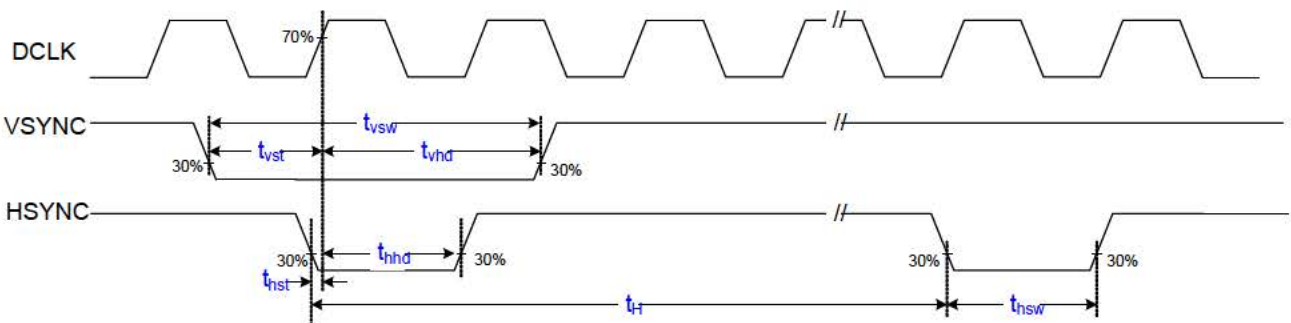
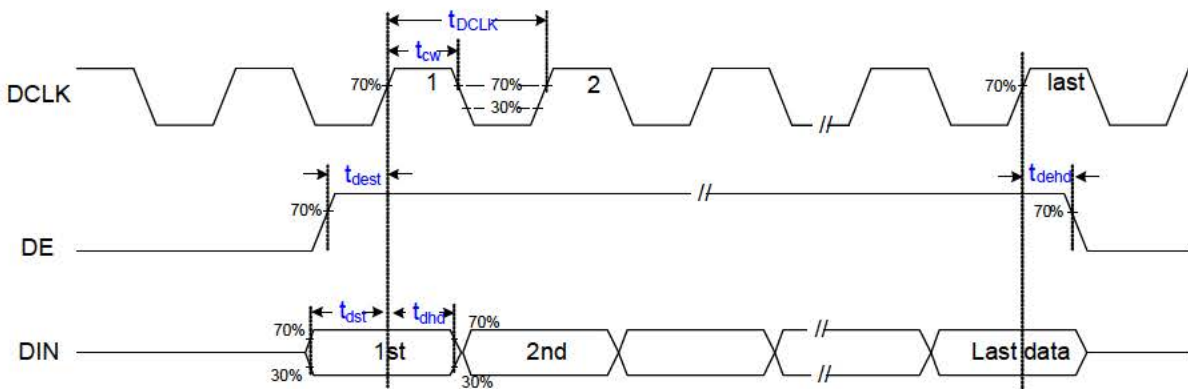

b. Serial port interface AC characteristics
(VDDSI=1.65 ~ VDD)

3-wire serial communication AC timing					
Parameter	Symbol	Min	Typ	Max	Unit
CSB input setup time	t_{s0}	50	-	-	ns
CSB input hold time	t_{h0}	50	-	-	ns
CSB pulse high width	t_{w2}	400	-	-	us
SDA input setup time	t_{s1}	50	-	-	ns
SDA input hold time	t_{h1}	50	-	-	ns
SCL pulse low width	t_{w1L}	50	-	-	ns
SCL pulse high width	t_{w1H}	50	-	-	ns

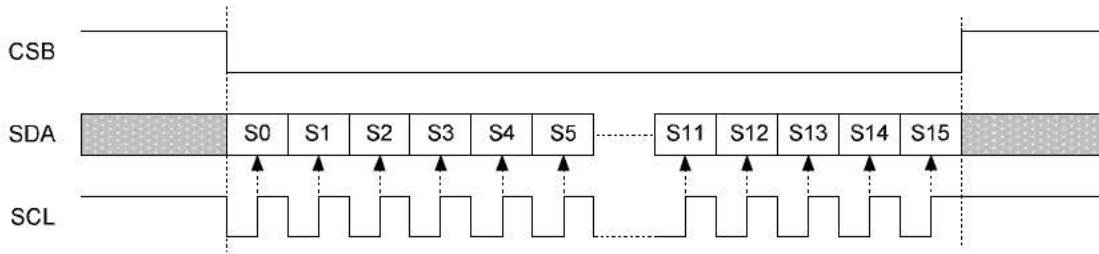

b. Input Timing

Parameter		Symbol	Min.	Typ.	Max.	Unit.	Remark
DCLK	Frequency	$1/t_{DCLK}$	5	9.5	12	MHz	
Frame Rate	Frequency		55	60	70	Hz	
1 Frame Scanning Time	Cycle	t_v	282	288	400	t_H	
	Display Period	t_{vd}	272			t_H	
	Blanking	t_{vbl}	10	16	128	t_H	
1 Line Scanning Time	Cycle	t_H	525	550	800	t_{DCLK}	
	Display Period	t_{hd}	480			t_{DCLK}	
	Blanking	t_{hbl}	45	70	320	t_{DCLK}	

Vertical Timing of Input(DE mode)

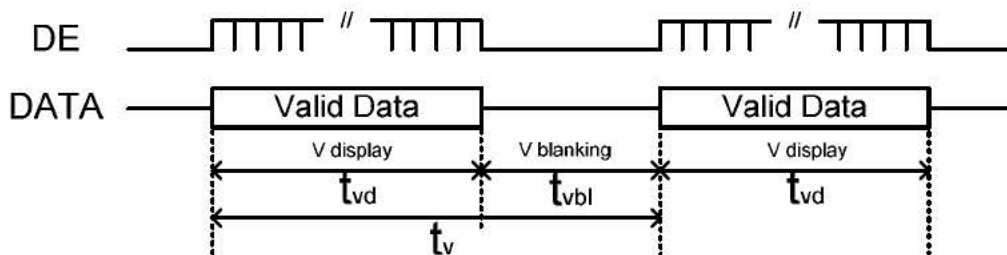

Horizontal Timing of Input (DE mode)

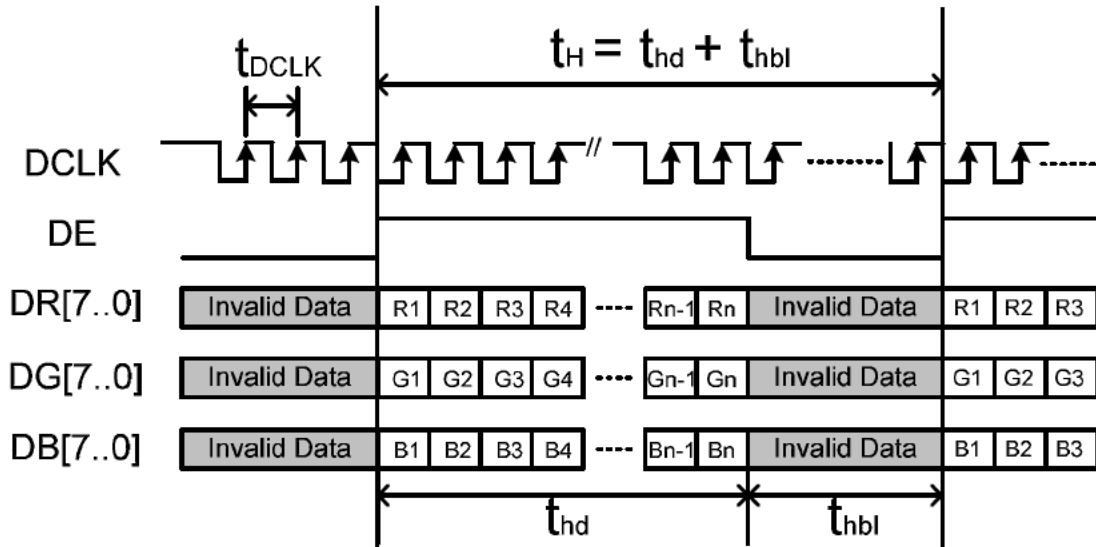

Note: The DE mode is being recommended as the first option.

5. Serial Interface Characteristics

5.1 3-Wire Command Format

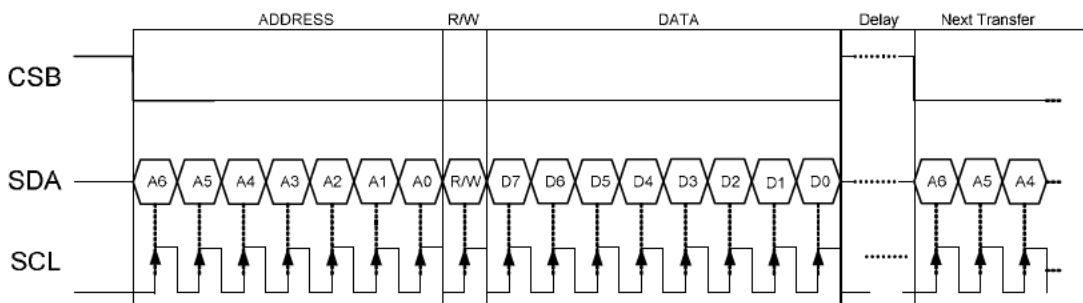

1. Each serial command consists of 16 bits of data which is loaded one bit a time at the rising edge of serial clock SCL.
2. Command loading operation starts from the falling edge of CSB and is completed at the next rising edge of CSB.
3. The serial control block is operational after power on reset, but commands are established by the VSYNC signal. If command is transferred multiple times for the same register, the last command before the VSYNC signal is valid.
4. If less than 16 bits of SCL are input while CSB is low, the transferred data is ignored.(Note1)
5. If 16 bits or more of SCL are input while CSB is low, the previous 16 bits of transferred data after the falling edge of CSB pulse are valid data.(Note2)
6. Serial block operates with the SCL clock.

7. Serial data can be accepted in the standby (power save) mode.

Note1 (data < 16bits):

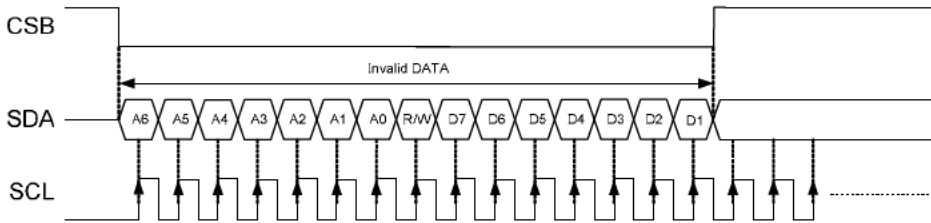

Note2 (data > 16bits):

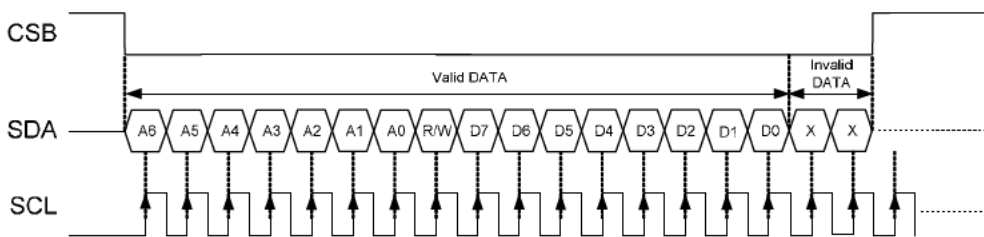

3-Wire Command Format:

MSB							LSB								
A6	A5	A4	A3	A2	A1	A0	R/W	D7	D6	D5	D4	D3	D2	D1	D0
Register Address [6:0]							Read or Write	DATA (Issue by external controller)							

3-Wire Writer Format:

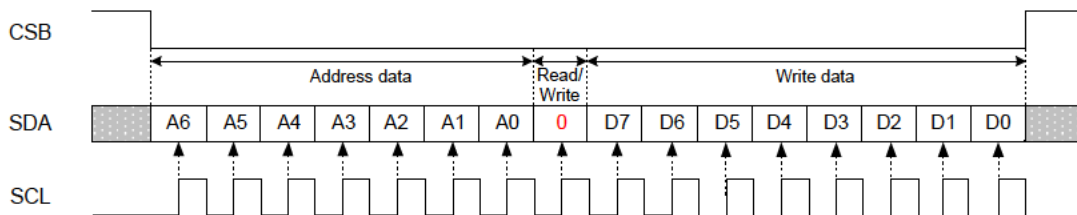

3-Wire Read Format:

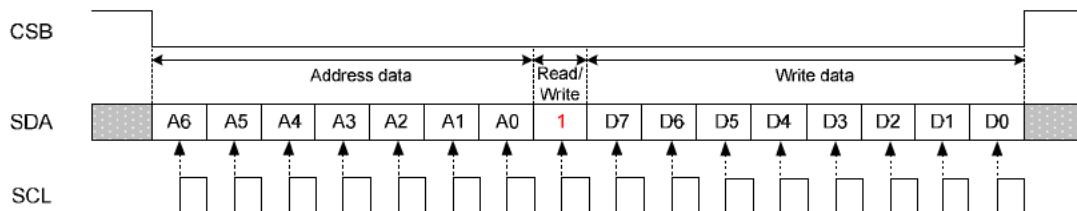

5.2 3-Wire Control Register List

NO.	Address								MSB	Initial value							LSB
	A6	A5	A4	A3	A2	A1	A0	R/W		D7	D6	D5	D4	D3	D2	D1	
R2	0	0	0	0	0	1	0	R/W(0)				CONTRAST_SW	CONTRAST_A				
									0	0	0	1	0	1	0	0	
R3	0	0	0	0	0	1	1	R/W(0)	BRIGHTNESS (40h)								
R5	0	0	0	0	1	0	1	R/W(0)		GRB							STB
									0	1	0	1	1	1	1	1	0
R12	0	0	0	1	1	0	0	R/W(0)					DEpol				DCLK
									0	0	0	0	0	0	0	0	0
R13	0	0	0	1	1	0	1	R/W(0)	CONTRAST_GRB (40h)								
R14	0	0	0	1	1	1	0	R/W(0)	SUB_CONTRAST_R (40h)								
R15	0	0	0	1	1	1	1	R/W(0)	SUB_BRIGHTNESS_R (40h)								
R16	0	0	1	0	0	0	0	R/W(0)	SUB_CONTRAST_B (40)								
R17	0	0	1	0	0	0	1	R/W(0)	SUB_BRIGHTNESS_B (40)								

5.3 Suggested Serial Command Settings

Power ON

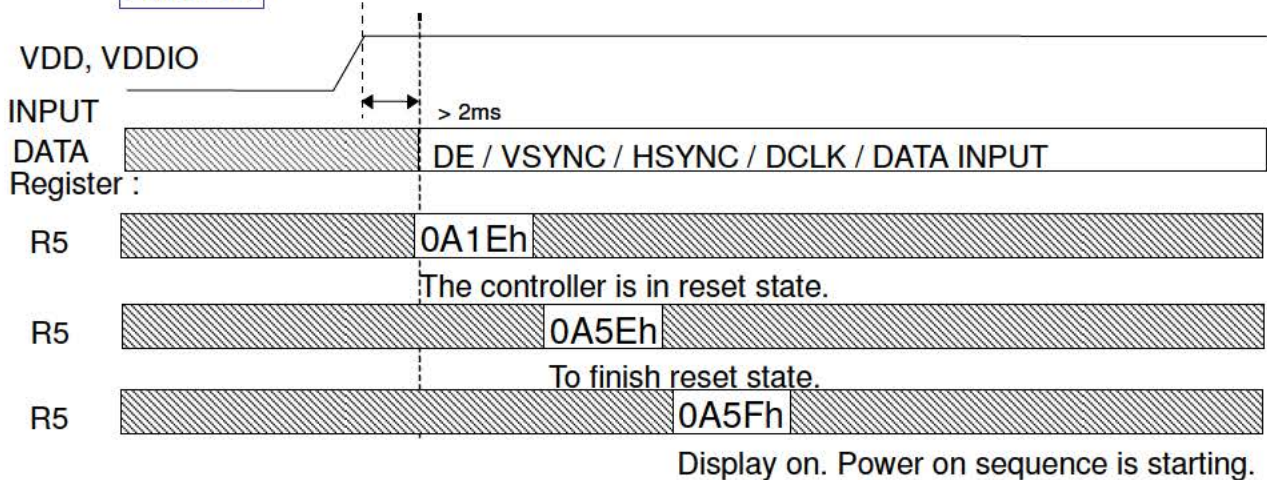

Power OFF

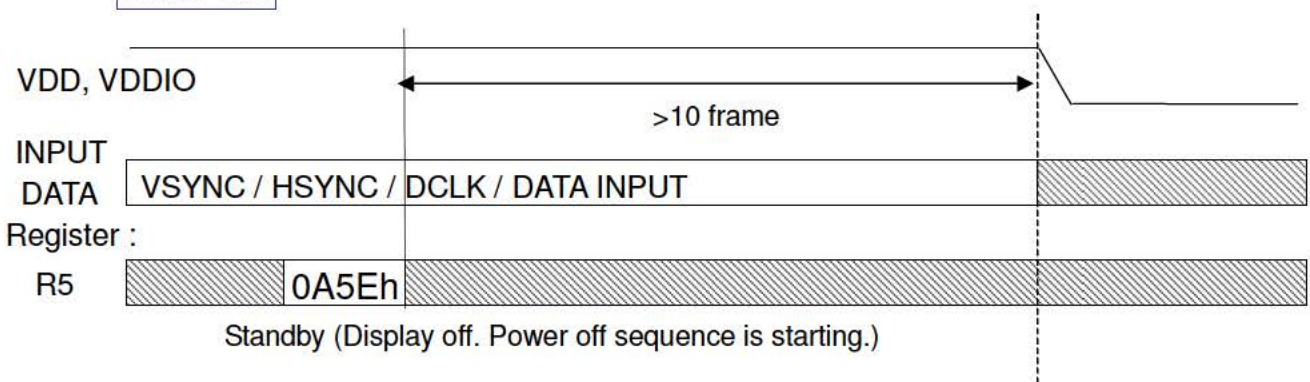

5.4 3-wire Registers Function Description

R02 Register

Bit	Name	Initial	R/W	Description
Bit[7:5]	-	-	-	Reserve
Bit [4]	CONTRAST_SW	01h	R/W	4-bit or 8-bit contrast selection. CONTRAST_SW = "0", 4bit contrast, Contrast_A(R02) CONTRAST_SW = "1", 8bit contrast, Contrast_RGB(R13). (Default)
Bit[3:0]	CONTRAST_A[3:0]	04h	R/W	RGB contrast level setting.

CONTRAST_A: RGB contrast level setting, the gain changes 0.25 / bit.

CONTRAST_A[3:0]	Contrast level
00h	0
:	:
04h(Default)	1
:	:
0Fh	3.75

R03 Register

Bit	Name	Initial	R/W	Description
Bit[7:0]	BRIGHTNESS[7:0]	40h	R/W	Display Brightness level adjustment register. (1 step/bit) Adjust range from 00h(level = -64) to FFh(level = +191) Default 40h(level = +0)

BRIGHTNESS: RGB brightness level setting, setting accuracy: 1 step / bit

BRIGHTNESS[7:0]	Brightness level
00h	Dark(-64)
:	:
40h(Default)	Center(0)
:	:
FFh	Bright(+191)

R05 Register

Bit	Name	Initial	R/W	Description
Bit [6]	GRB	01h	R/W	Register reset setting. GRB = "0", Reset all registers to default value. GRB = "1", Normal operation. (Default)
Bit [0]	STB	00h	R/W	Standby (Power saving) mode setting. STB = "0", Standby; timing control, DAC, and DC/DC converter are off, and register data should be kept. (Default) STB = "1", Normal operation, with power on/off sequence.

R12 Register

Bit	Name	Initial	R/W	Description
Bit[7:4]	-	-	-	Reserve
Bit[3]	DEpol	00h	R/W	DE polarity selection. DEpol = "0", Positive polarity. (Default) DEpol = "1", Negative polarity
Bit[0]	DCLKpol	00h	R/W	DCLK polarity selection. DCLKpol = "0", Positive polarity. (Default) DCLKpol = "1", Negative polarity

DEpol=0, Hdpol=1, Vdpol=1, DCLKpol=0

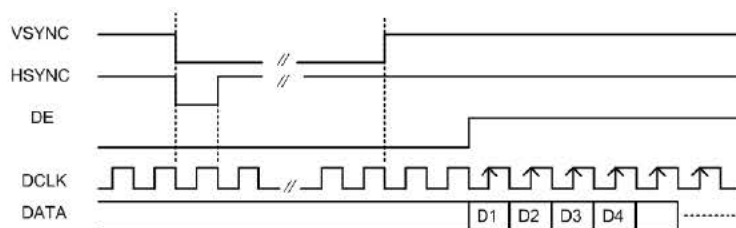

DEpol=1, Hdpol=0, Vdpol=0, DCLKpol=1

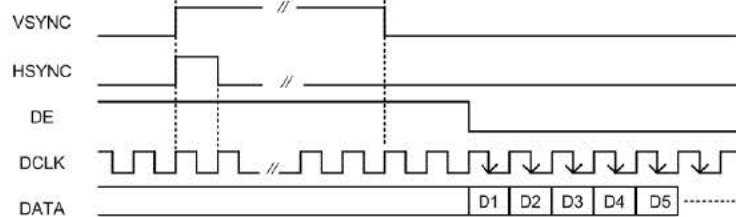

R13 Register

Bit	Name	Initial	R/W	Description
Bit[7:0]	CONTRAST_RGB[7:0]	40h	R/W	RGB contrast level setting.

CONTRAST_RGB: RGB contrast level setting, the gain changes (1/64) / bit

CONTRAST_RGB[7:0]	Contrast level
00h	0
:	:
40h(Default)	1
:	:
FFh	3.984

R14 Register

Bit	Name	Initial	R/W	Description
Bit[7]	-	-	-	Reserve.
Bit[6:0]	SUB-CONTRAST_R[6:0]	40h	R/W	R sub-contrast level setting.

R16 Register

Bit	Name	Initial	R/W	Description
Bit[7]	-	-	-	Reserve.
Bit[6:0]	SUB-CONTRAST_B[6:0]	40h	R/W	B sub-contrast level setting.

SUB-CONTRAST: R/B sub-contrast level setting, the gain changes (1/256) / bit

SUB-CONTRAST_R/B[6:0]	Sub-Contrast level
00h	0.75
:	:
40h(Default)	1
:	:
7Fh	1.246

R15 Register

Bit	Name	Initial	R/W	Description
Bit[7]	-	-	-	Reserve.
Bit[6:0]	SUB-BRIGHTNESS_R[6:0]	40h	R/W	R sub-brightness level setting.

R17 Register

Bit	Name	Initial	R/W	Description
Bit[7]	-	-	-	Reserve.
Bit[6:0]	SUB-BRIGHTNESS_B[6:0]	40h	R/W	B sub-brightness level setting.

SUB-BRIGHTNESS: R/B sub-brightness level setting, setting accuracy 1 step / bit

SUB-BRUGHTNESS_R/B[6:0]	Sub-Brightness level
00h	Dark(-64)
:	:
40h(Default)	Center(0)
:	:
7Fh	Bright(+63)

Contrast / Brightness circuit

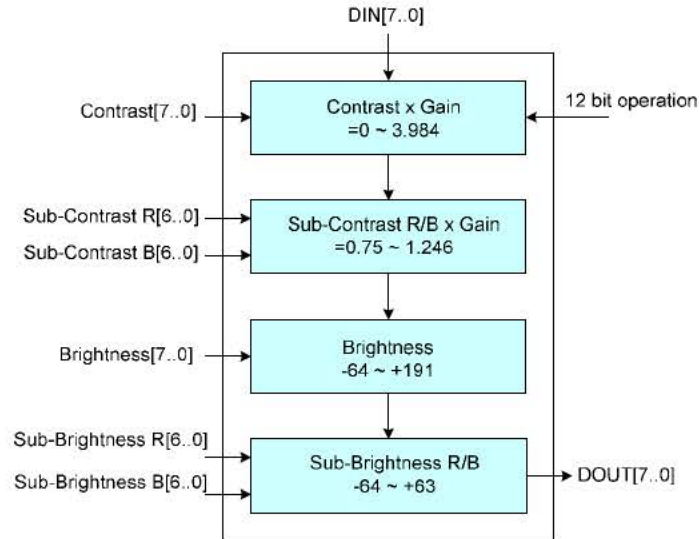

Contrast Circuit

- 8-bit serial setting to control the contrast (gain) for RGB signals
- 7-bit sub-contrast adjustment for R/B

$$DOUT_G[7:0] = DIN[7:0] \times Contrast[0 \text{ to } 1.0 \text{ to } 3.984]$$

$$DOUT_R[7:0] = DIN[7:0] \times Contrast[0 \text{ to } 1.0 \text{ to } 3.984] \times \text{sub-contrast R} [0.75 \text{ to } 1.0 \text{ to } 1.246]$$

$$DOUT_B[7:0] = DIN[7:0] \times Contrast[0 \text{ to } 1.0 \text{ to } 3.984] \times \text{sub-contrast B} [0.75 \text{ to } 1.0 \text{ to } 1.246]$$

Note: output values above "255" clipped.

CONTRAST	00h	to	40h(Default)	to	FFh
Gain value range	0	to	1	to	3.984

SUB-CONTRAST R/B	00h	to	40h(Default)	to	7Fh
Gain value range	0.75	to	1	to	1.246

Brightness Circuit

- 8-bit serial setting to control the RGB brightness level
- 7-bit serial setting to control the R/B sub-brightness level

$$DOUT_G[7:0] = DIN_G[7:0] + Bright[-64 \text{ to } 0 \text{ to } +191]$$

$$DOUT_R[7:0] = DIN_R[7:0] + Bright[-64 \text{ to } 0 \text{ to } +191] + \text{Sub-bright R}[-64 \text{ to } 0 \text{ to } +63]$$

$$DOUT_B[7:0] = DIN_B[7:0] + Bright[-64 \text{ to } 0 \text{ to } +191] + \text{Sub-bright B}[-64 \text{ to } 0 \text{ to } +63]$$

Note: Output values below "0" and above "255" clipped.

BRIGHTNESS	00h	to	40h(Default)	to	FFh
Variable range	-64	to	0	to	+191

SUB-BRIGHTNESS R/B	00h	to	40h(Default)	to	7Fh
Variable range	-64	to	0	to	+63

5. Power On/Off Characteristics

a. Recommended Power On Sequence

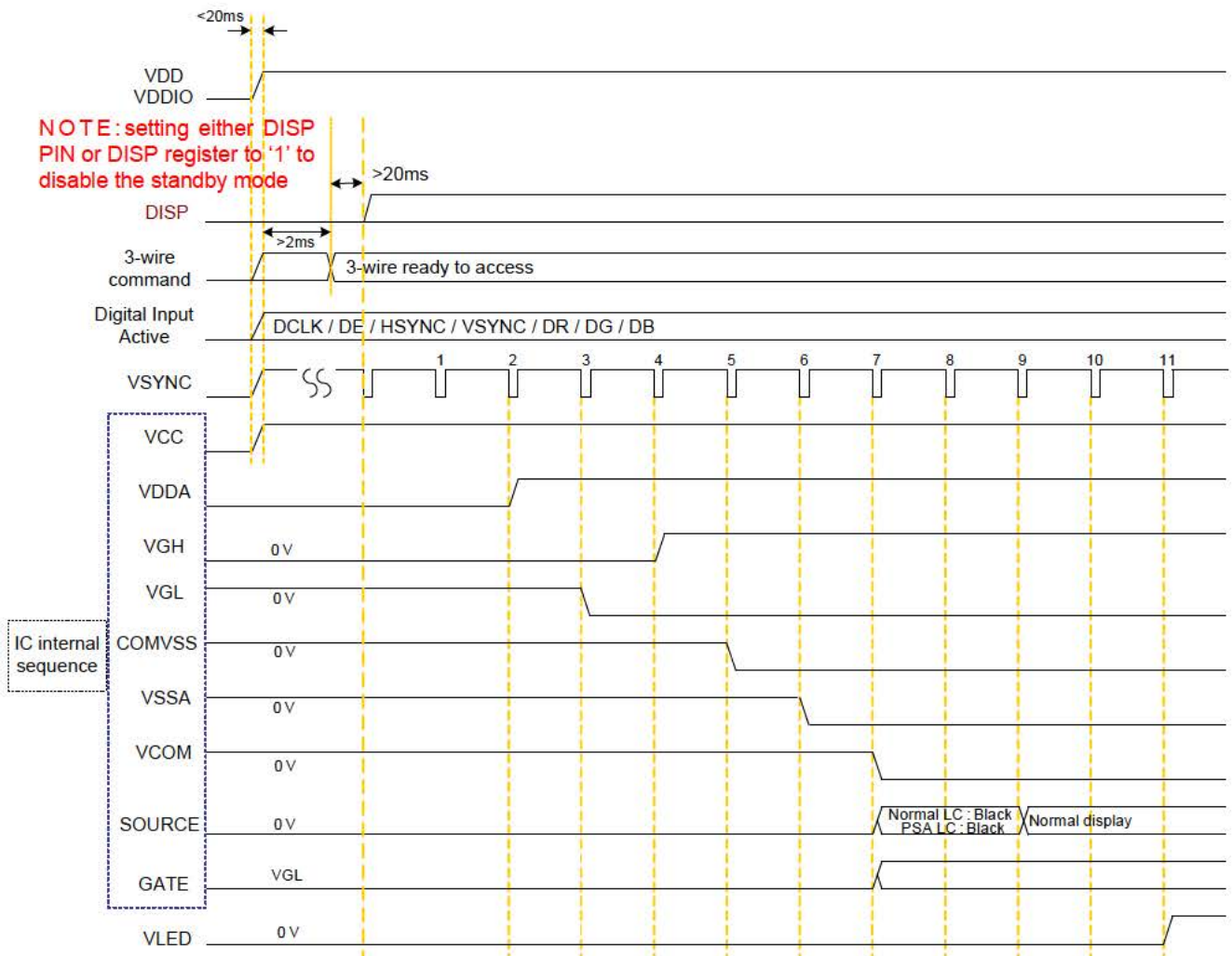

Note1 : The LCD driver is in default standby mode after VDD/VDDIO power-on, and setting either PIN DISP or SPI DISP to '1' to disable the standby mode is required for normal operation.

Note2 : After PIN DISP or SPI DISP set to 1, it takes 10 VSYNC periods for power on operation.

b. Recommended Power Off Sequence

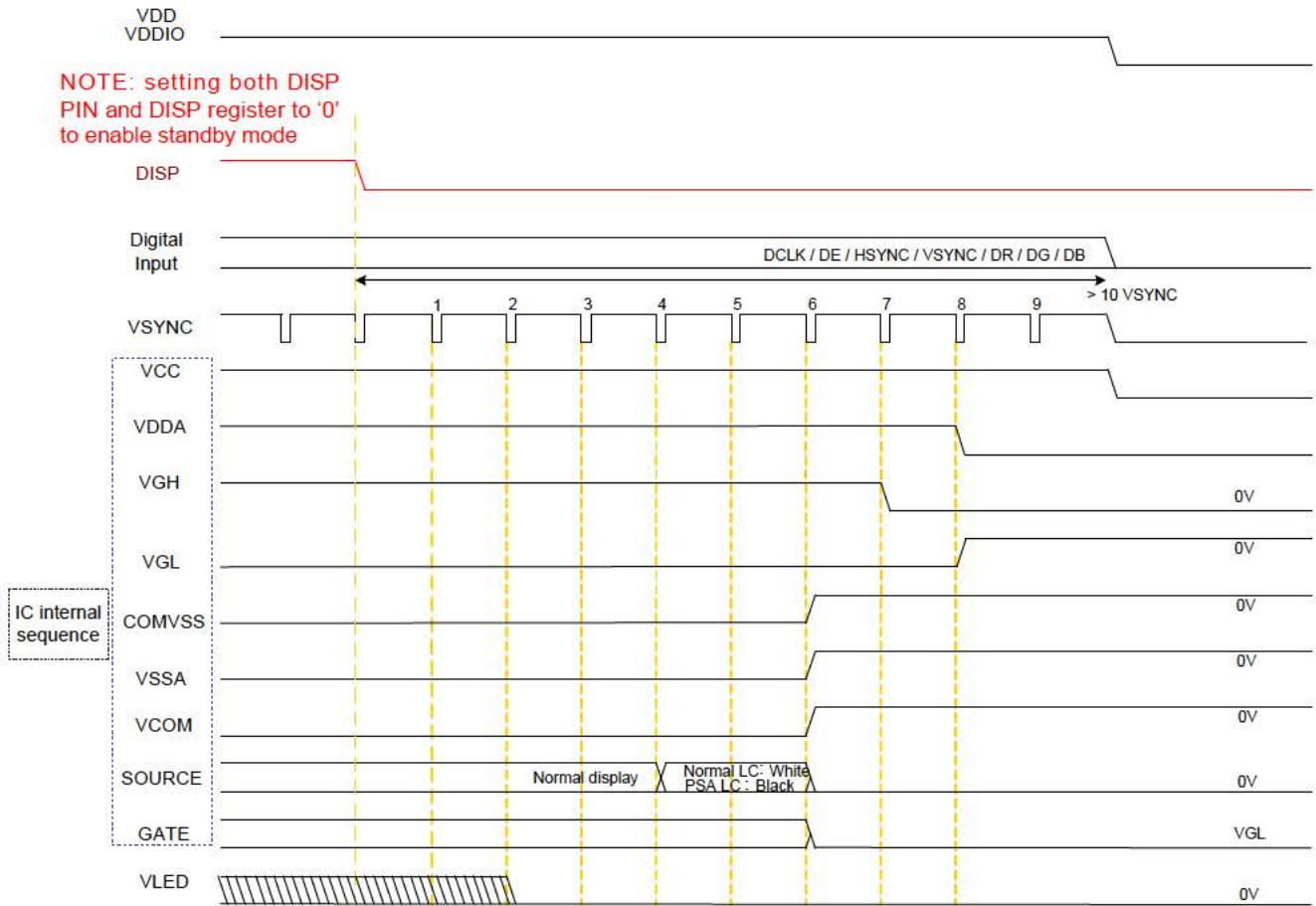

Note1 : When the PIN DISP and SPI DISP are set to '0' to enable standby mode, a build-in power off sequence is started.

Note2 : For properly power off operation, the extra 10 VSYNC periods after DISP(SPI and PIN) set to low were required.

Note3 : Only when PIN DISP='0', SPI DISP='0', the system would enter standby mode. Other conditions would keep normal operation.

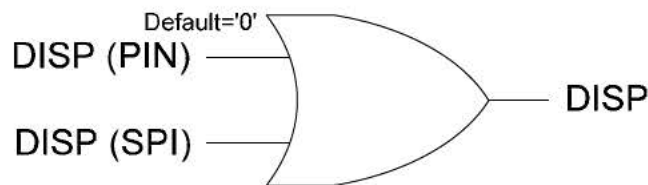

D. Optical Specification

All optical specification is measured under typical condition (Note 1, 2)

Item	Symbol	Condition	Min.	Typ.	Max.	Unit	Remark
Response Time Rise	Tr	$\theta=0^\circ$	-	7	-	ms	Note 3
	Tf		-	23	-	ms	
Contrast ratio	CR	At optimized viewing	400	500	-		Note 4
Viewing Angle Top Bottom Left Right		$CR \geq 10$	-	40	-	deg.	Note 5
			-	60	-		
			-	70	-		
			-	70	-		
Brightness	Y_L	$\theta=0^\circ$	320	400	-	cd/m ²	Note 6
Uniformity	ΔY_L	%	75	80	--	%	Note 7
Chromaticity	Rx	$\theta=0^\circ$	0.55	0.59	0.63		
	Ry	$\theta=0^\circ$	0.30	0.34	0.38		
	Gx	$\theta=0^\circ$	0.29	0.34	0.39		
	Gy	$\theta=0^\circ$	0.53	0.58	0.69		
	Bx	$\theta=0^\circ$	0.11	0.16	0.21		
	By	$\theta=0^\circ$	0.07	0.12	0.17		
	Wx	$\theta=0^\circ$	0.26	0.31	0.36		
	Wy	$\theta=0^\circ$	0.28	0.33	0.38		

Note 1: Ambient temperature =25°C, and LED lightbar voltage $V_L = 18.6$ V. To be measured in the dark room.

Note 2: To be measured on the center area of panel with a viewing cone of 1° by Topcon luminance meter BM-5A, after 15 minutes operation.

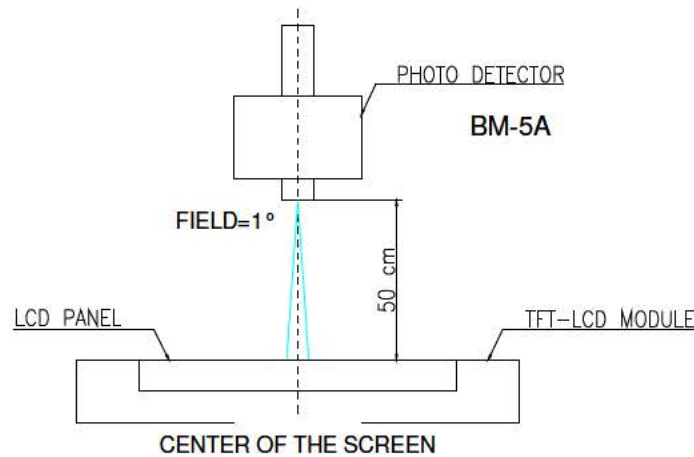

Note 3: Definition of response time:

The output signals of photo detector are measured when the input signals are changed from "black" to "white"(falling time) and from "white" to "black"(rising time), respectively.

The response time is defined as the time interval between the 10% and 90% of amplitudes.

Refer to figure as below.

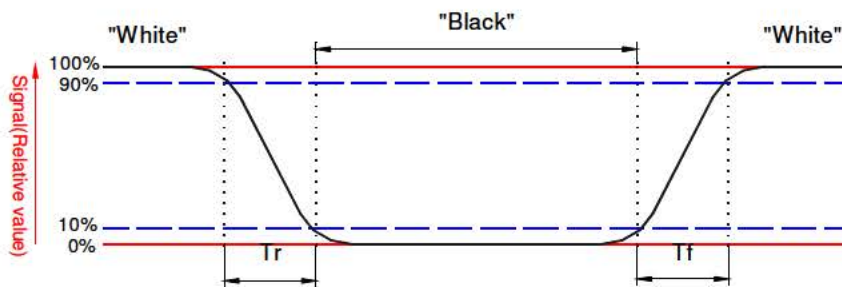

Note 4. Definition of contrast ratio:

Contrast ratio is calculated with the following formula.

$$\text{Contrast ratio (CR)} = \frac{\text{Photo detector output when LCD is at "White" status}}{\text{Photo detector output when LCD is at "Black" status}}$$

Note 5. Definition of viewing angle, θ , Refer to figure as below.

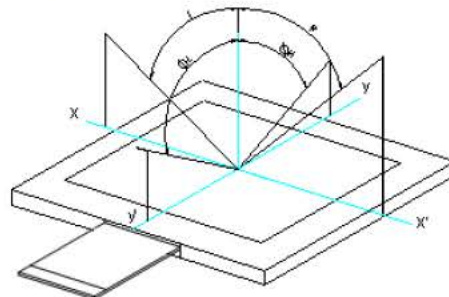

Note 6. Average measure at the 9 points area (as Note 7) of the panel when all the input terminals of LCD panel are electrically opened.

Note 7: Luminance Uniformity of these 9 points is defined as below:

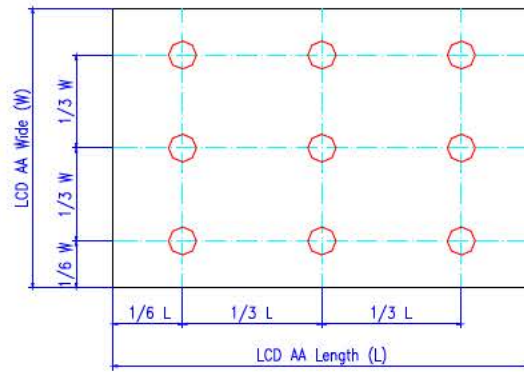

$$\text{Uniformity} = \frac{\text{minimum luminance in 9 points (1-9)}}{\text{maximum luminance in 9 points (1-9)}}$$

E. Touch Screen Panel Specifications

1. FPC Pin Assignment

Pin No.	Symbol	I/O	Description
1	X1	I/O	Touch panel right electrode (R)
2	Y2	I/O	Touch panel bottom electrode (B)
3	X2	I/O	Touch panel left electrode (L)
4	Y1	I/O	Touch panel top electrode (U)

2. Electrical Characteristics

Item	Min.	Typ	Max.	Unit	Remark	
Rate DC Voltage	--	--	7	V		
Resistance	X (Film)	300	--	1600	Ω	At connector
	Y (Glass)	100	--	800		
Linearity	-1.5%		1.5%	--	Note 1	
Insulation Resistance	20			M Ω	DC 25V	

Note 1: Measurement condition of Linearity: difference between actual voltage & theoretical voltage is an error at any points. Linearity is the value max. error voltage divided by voltage difference on active area inside 4mm ,150g.

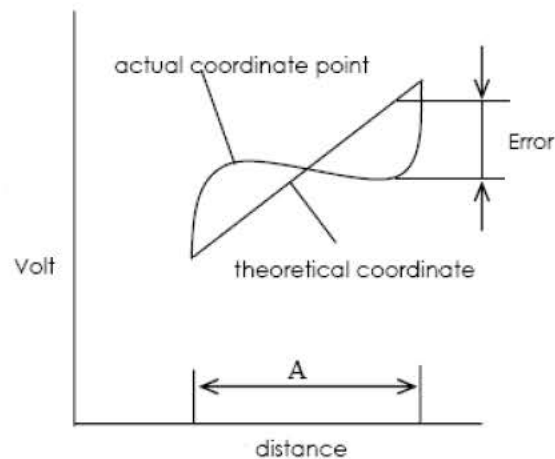

3. Mechanical Characteristics

Item	Min.	Max.	Unit	Remark
Hardness of Surface	3	--	H	JIS K-5600
Operation Force (Pen or Finger)	--	50	gf	Note 1, 2
Chattering		10	ms	
Dot pitch	3		mm	
Dot size	0.035*0.035		mm	

Note 1: Within "active area inside 5mm", but not near the active area boundary and on the dot-spacer.

Note 2: Operation force measurement is under test condition as figure below.

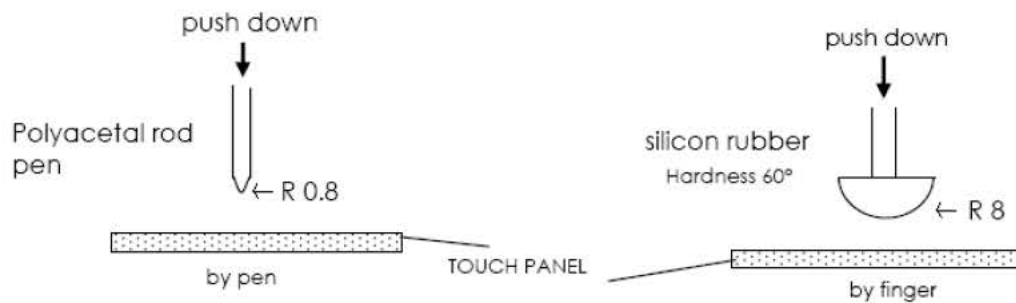

4. Life Test Condition

Item	Min.	Max.	Unit	Remark
Notes Life	10^5	--	lines	Note 1, 2
Input Life	10^6	--	times	Note 1, 3

Note 1: Notes Life test condition (by pen): slide on central 2/3 of active area and use R 0.8mm polyacetal pen, input force : 250gf, frequency : 60mm/sec. Sliding from A to B complete 1 time. shown as figure.

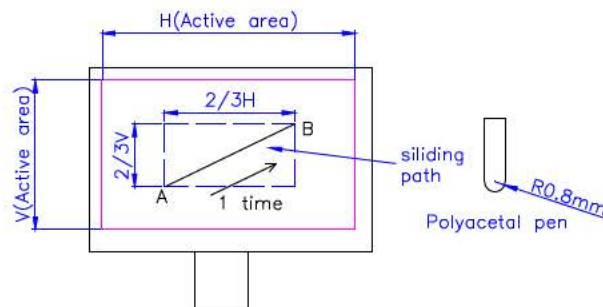

Note 2: Input Life test condition (by finger): test position on active area center and use R8.0mm silicon rubber (hardness 60°), test force: 250gf, frequency : 2times/sec. shown as figure.

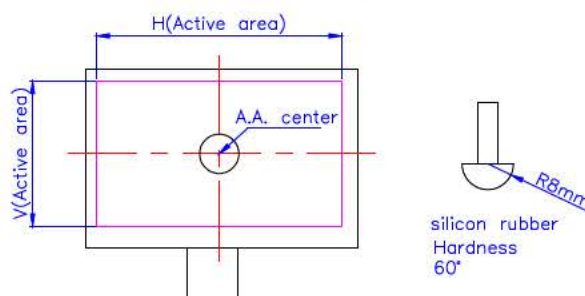

5. Attention

Please pay attention for below matters at mounting design for touch panel of LCD module.

- 1) To prevent abnormal work on touch function, casing and T/P ITO film should have a gap.
Suggestion design show as below figure.
- 2) Cushion area and casing opening must be followed mechanical drawing.
- 3) Don't use glue, hard or conductive material as a cushion to enclosure touch panel.
- 4) The touch panel edge is conductive. Do not touch it with any conductive part after mounting.

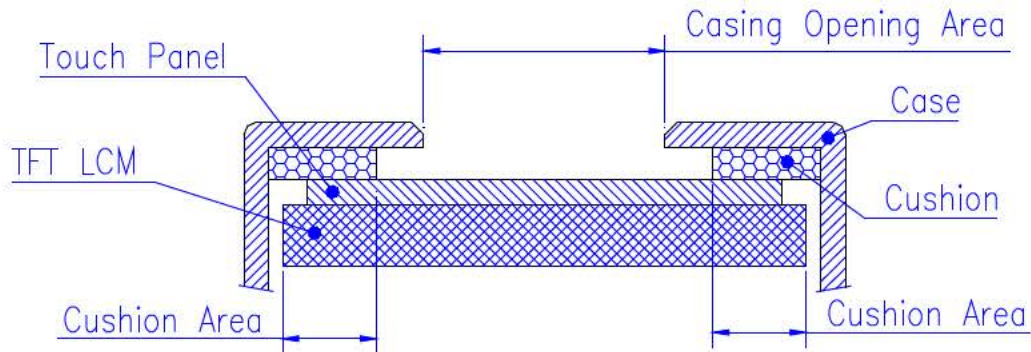

- 5) If users want to cleaning touch panel by air gun, pressure 2kg/cm^2 below is suggested.
- 6) Do not input with a heavy shock or stress on touch panel and film surface. Ex. Don't transfer the panel from film face with vacuum.
- 7) Do not lift LCD module by FPC.
- 8) Please use dry cloth or soft cloth with neutral detergent (after wring dry) or one with ethanol at cleaning. Do not use any organic solvent, acid or alkali solution.
- 9) Do not pile touch panels. Do not put heavy goods on touch panels.

F. Reliability Test Items

(The following reliability conditions can be modified according to the actual test results of samples used cost down materials)

No.	Test items	Conditions	Remark
1	High Temperature Storage	Ta= 85°C 240Hrs	Note 3
2	Low Temperature Storage	Ta= -40°C 240Hrs	Note 3
3	High Ttemperature Operation	Tp= 70°C 240Hrs	Note 3
4	Low Temperature Operation	Ta= -30°C 240Hrs	Note 3
5	High Temperature & High Humidity	Tp= 60°C, 90% RH 240Hrs	Operation/ Note 3
6	Heat Shock	-40°C ~85°C /20 cycles 18min/cycle	Non-operation/ Note 3
7	Electrostatic Discharge	Contact = ± 4 kV, class B Air = ± 8 kV, class B	Note 4
8	Image Sticking	40°C, 6hrs	Note 5/ Note 3
9	Flicker	-28dB	
10	Vibration	Frequency range : 8~33.3Hz Stoke : 1.3mm Sweep : 2.9G ,33.3~400Hz 2 hours for each direction of X,Y,Z 4 hours for Y direction	Non-operation JIS C7021, A-10 condition A : 15 minutes
11	Mechanical Shock	100G . 6ms, ±X,±Y,±Z 3 times for each direction	Non-operation JIS C7021, A-7 condition C
12	Vibration (With Carton)	Random vibration: 0.015G ² /Hz from 5~200Hz -6dB/Octave from 200~500Hz	IEC 68-34
13	Drop (With Carton)	Height: 60cm 1 corner, 3 edges, 6 surfaces	
14	Cross talk	U - U' × U < 2% @1/2 gray scale Same formula for other three positions	Note 6

Note 1: Ta: Ambient Temperature. Tp: Panel Surface Temperature

Note 2: In the standard conditions, there is not display function NG issue occurred. All the cosmetic specification is judged before the reliability stress.

Note 3: All the ununiform optical performance caused by polarizer need to be ignored.

Note 4 : All test techniques follow IEC6100-4-2 standard.

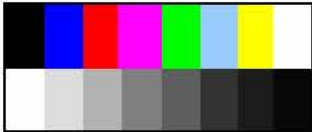
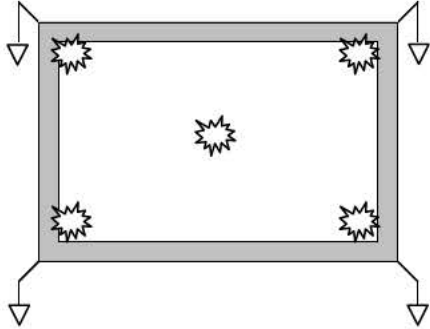
Test Condition		
Pattern		
Procedure And Set-up	<p><u>Contact Discharge</u> : 330Ω, 150pF, 1sec, 5point, 10times/point <u>Air Discharge</u> : 330Ω, 150pF, 1sec, 5 point, 10times/point</p>  <p><u>Note</u> :</p> <ol style="list-style-type: none"> 1. The metal casing is connected to ground (0V) at four corners. 2. All register commands are repeating transferred. 3. Judging the result after discharging. 	
Criteria	<p>B – Some performance degradation allowed. No data lost. Self-recoverable hardware failure.</p>	
Others	<ol style="list-style-type: none"> 1. Gun to Panel Distance 2. No SPI command, keep default register settings. 	

Note 5: Keep showing below testing patterns with the defined temperature conditions, then judge with 50% gray level and viewing distance as 30cm. There are 2 acceptable conditions:

- For checking LCM at penperdicular, mura JND is less than or equal to 2.5
- Other viewing direction: mura JND is less than or equal to 2.8

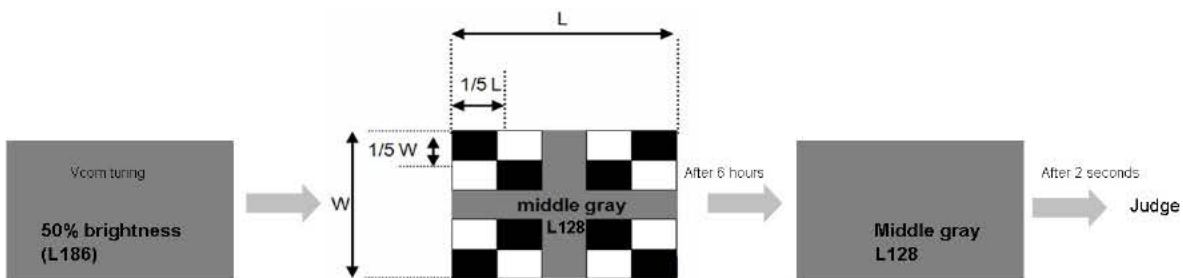

G. Packing and Marking

1. Packing Form

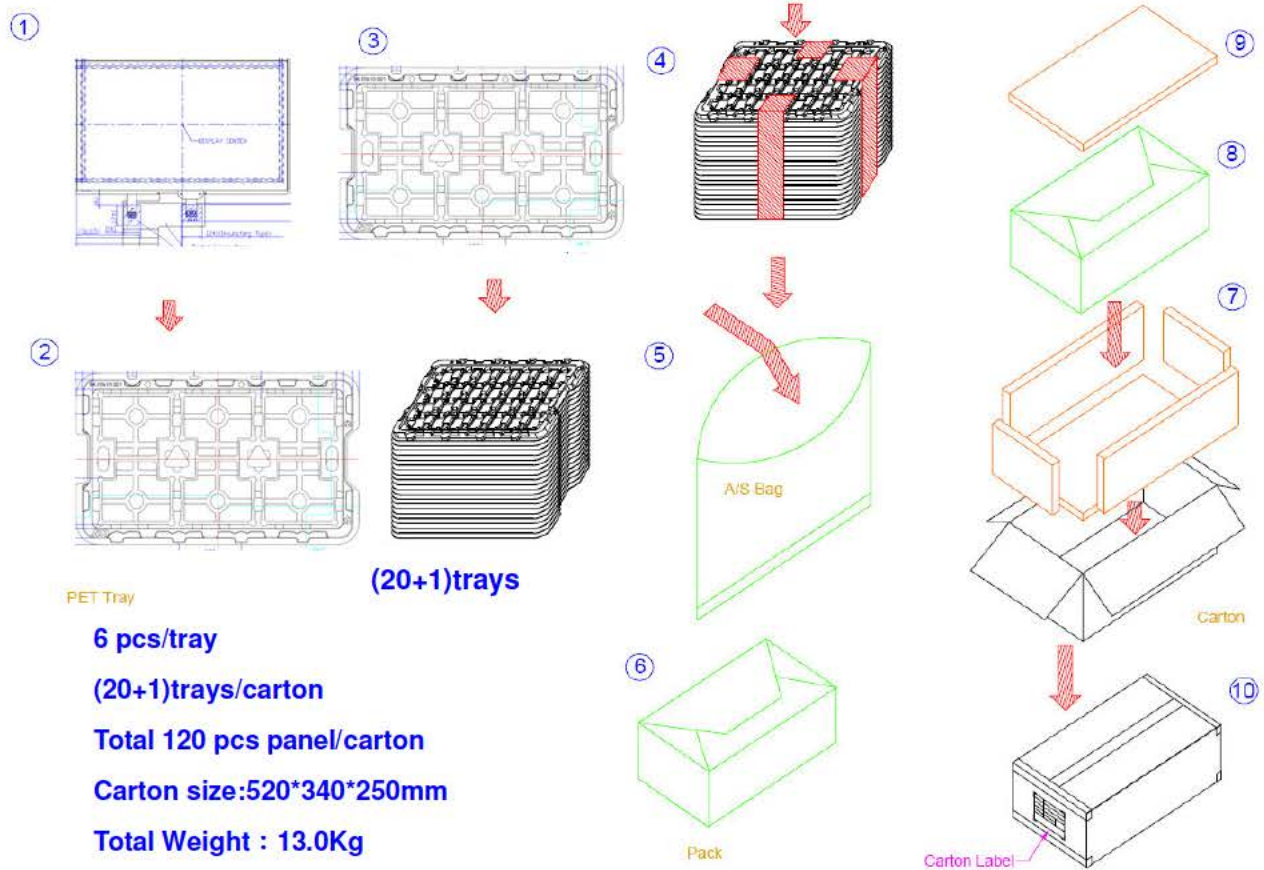

2. Module/Panel Label Information

The module/panel (collectively called as the “Product”) will be attached with a label of Shipping Number which represents the identification of the Product at a specific location. Refer to the Product outline drawing for detailed location and size of the label. The label is composed of a 22-digit serial number with the following definition:

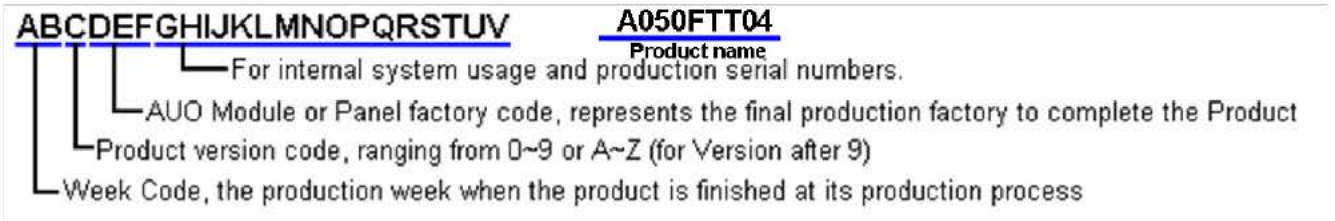

Example:

270S06ZS3A06V102P80200:

Product Manufacturing Week Code: WK27

Product Version: Version 0

Product Manufacturing Factory: S06

Internal Production Control Number: ZS3A06V102P80200

Product Level: Z

Module Lot Number : S3A06V102P8,

S: Factory side

3A: Production Location

0: Year code (2010)

6V102P8: Lot-Number

Serial Number: 0200

Product Name: A050FTT04

H. Application Note

1. Application Circuit

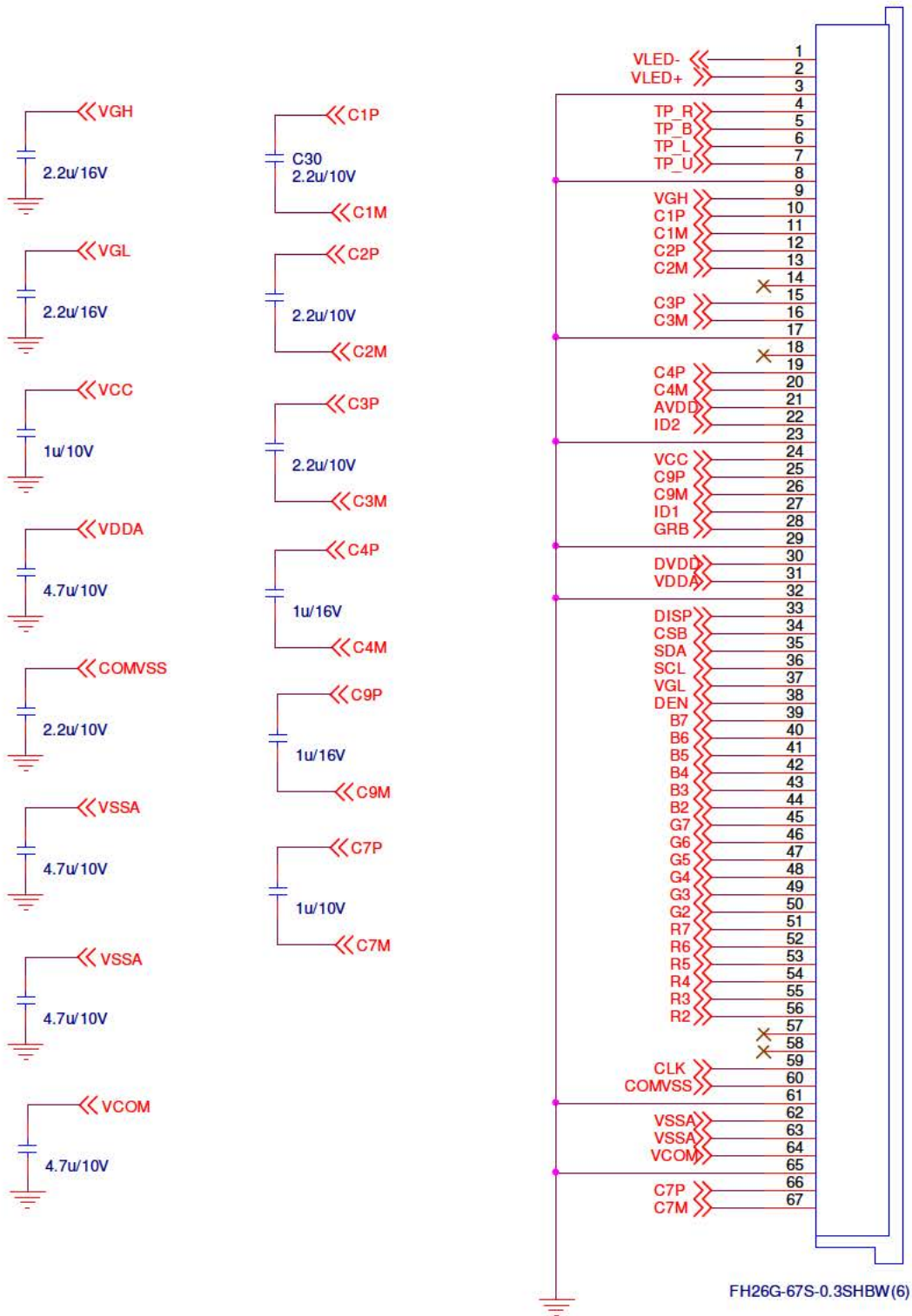

I. Precautions

1. Do not twist or bend the module and prevent the unsuitable external force for display module during assembly.
2. Adopt measures for good heat radiation. Be sure to use the module with in the specified temperature.
3. Avoid dust or oil mist during assembly.
4. Follow the correct power sequence while operating. Do not apply the invalid signal, otherwise, it will cause improper shut down and damage the module.
5. Less EMI: it will be more safety and less noise.
6. Please operate module in suitable temperature. The response time & brightness will drift by different temperature.
7. Avoid to display the fixed pattern (exclude the white pattern) in a long period, otherwise, it will cause image sticking.
8. Be sure to turn off the power when connecting or disconnecting the circuit.
9. Polarizer scratches easily, please handle it carefully.
10. Display surface never likes dirt or stains.
11. A dewdrop may lead to destruction. Please wipe off any moisture before using module.
12. Sudden temperature changes cause condensation, and it will cause polarizer damaged.
13. High temperature and humidity may degrade performance. Please do not expose the module to the direct sunlight and so on.
14. Acetic acid or chlorine compounds are not friends with TFT display module.
15. Static electricity will damage the module, please do not touch the module without any grounded device.
16. Do not disassemble and reassemble the module by self.
17. Be careful do not touch the rear side directly.
18. No strong vibration or shock. It will cause module broken.
19. Storage the modules in suitable environment with regular packing.
20. Be careful of injury from a broken display module.
21. Please avoid the pressure adding to the surface (front or rear side) of modules, because it will cause the display non-uniformity or other function issue.