

# CUSTOMER APPROVAL SHEET

<b>Company Name</b>	
<b>MODEL</b>	<b>A070FW00 V6</b>
<b>CUSTOMER APPROVED</b>	Title :  Name :

- APPROVAL FOR SPECIFICATIONS ONLY (Spec. Ver.\_\_\_\_)
- APPROVAL FOR SPECIFICATIONS AND ES SAMPLE (Spec. Ver.\_\_\_\_)
- APPROVAL FOR SPECIFICATIONS AND CS SAMPLE (Spec. Ver.\_\_\_\_)
- CUSTOMER REMARK :

AUO PM : Orion Peng

P/N : 91.07A01.600

Comment :



Doc. version :	0.0
Total pages :	28
Date :	2009/03/18

# Product Specification

## 7.0" COLOR TFT-LCD MODULE

**Model Name :** **A070FW00 V6**

---

**Planned Lifetime:** From 2009/Mar To 2010/Dec

---

**Phase-out Control:** From 2010/Jul To 2010/Dec

---

**EOL Schedule:** 2010/Jul

---

< ◆ > Preliminary Specification

< > Final Specification

Note: The content of this specification is subject to change.

© 2009 AU Optronics  
All Rights Reserved,  
Do Not Copy.



Record of Revision

Version	Revise Date	Page	Content
0.0	2009/03/10	All	First Draft



## Contents

<b>A. General Information</b>	<b>3</b>
<b>B. Outline Dimension</b>	<b>4</b>
1. TFT-LCD Semi-Module	4
<b>C. Electrical Specifications</b>	<b>5</b>
1. TFT LCD Panel Pin Assignment	5
2. Backlight Pin Assignment	6
3. Absolute Maximum Ratings	6
3. Electrical DC Characteristics	7
4. Electrical AC Characteristics	8
6. Power On/Off Characteristics	15
<b>D. Optical Specification</b>	<b>16</b>
<b>E. Reliability Test Items</b>	<b>18</b>
<b>F. Packing and Marking</b>	<b>20</b>
1. Packing Form	20
2. Module/Panel Label Information	21
3. Carton Label Information	21
<b>G. Precautions</b>	<b>22</b>

### A. General Information

This product is for portable DVD and digital photo frame application.

NO.	Item	Unit	Specification	Remark
1	Screen Size	inch	7.0(Diagonal)	
2	Display Resolution	dot	480RGB(W)×234(H)	
3	Overall Dimension	mm	162.53 (W)×94.08(H)×1.43(D)	Note 1
4	Active Area	mm	154.08(W)×86.58(H)	
5	Pixel Pitch	mm	0.107(W)×0.370(H)	
6	Color Configuration	--	R. G. B. Stripe	Note 2
7	NTSC Ratio	%	48%	
8	Display Mode	--	Normally White	
9	Panel surface Treatment	--	Anti-Glare, 3H	
10	Weight	g	46	
11	LCD Module Power Consumption	W	TBD	
12	Viewing direction		6 o'clock (gray inversion)	

Note 1: Not include backlight cable and FPC. Refer next page to get further information.

Note 2: Below figure shows dot stripe arrangement.

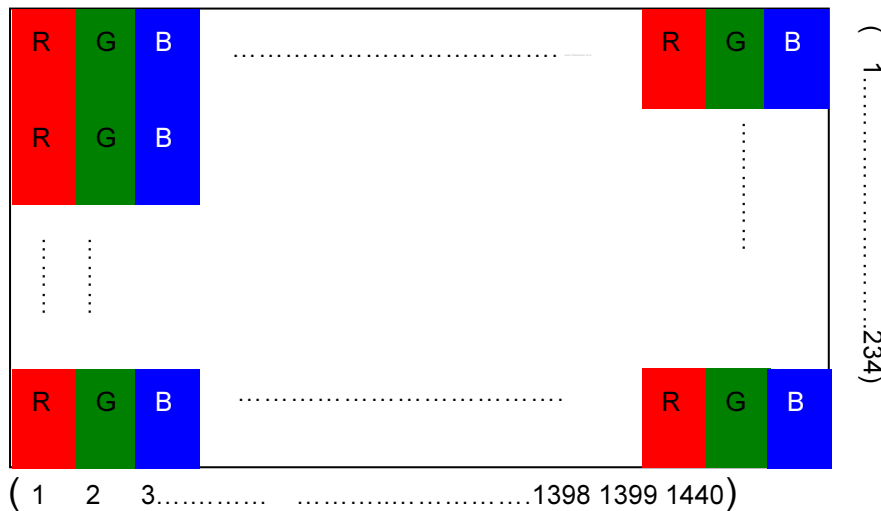



## B. Outline Dimension

### 1. TFT-LCD Semi-Module

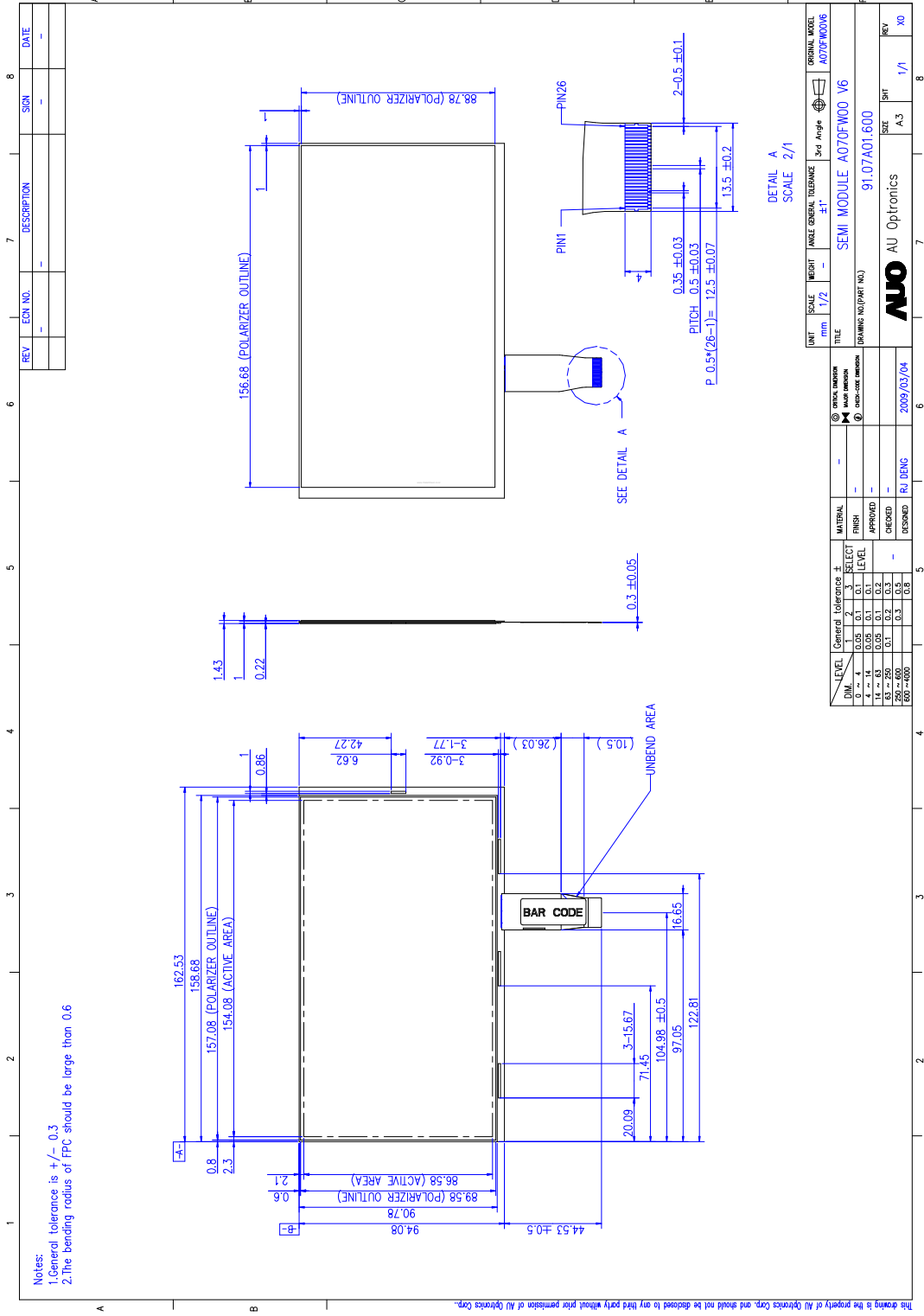

## C. Electrical Specifications

### 1. TFT LCD Panel Pin Assignment

Pin no	Symbol	I/O	Description	Remark
1	GND	-	Ground for logic circuit	
2	V <sub>CC</sub>	I	Supply voltage of logic control circuit for scan driver	
3	V <sub>GL</sub>	I	Negative power for scan driver	
4	V <sub>GH</sub>	I	Positive power for scan driver	
5	STVR	I/O	Vertical start pulse	Note 1
6	STVL	I/O	Vertical start pulse	Note 1
7	CKV	I	Shift clock input for scan driver	
8	U/D	I	UP/DOWN scan control input	Note 1,2
9	OEV	I	Output enable input for scan driver	
10	VCOM	I	Common electrode driving signal	
11	VCOM	I	Common electrode driving signal	
12	L/R	I	LEFT/RIGHT scan control input	Note 1,2
13	MOD	I	Sequential sampling and simultaneous sampling setting	
14	OEH	I	Output enable input for data driver	
15	STHL	I/O	Start pulse for horizontal scan line	Note 1
16	STHR	I/O	Start pulse for horizontal scan line	Note 1
17	CPH3	I	Sampling and shifting clock pulse for data driver	
18	CPH2	I	Sampling and shifting clock pulse for data driver	
19	CPH1	I	Sampling and shifting clock pulse for data driver	
20	V <sub>CC</sub>	I	Supply voltage of logic control circuit for data driver	
21	GND	-	Ground for logic circuit	
22	VR	I	Alternated video signal input(Red)	
23	VG	I	Alternated video signal input(Green)	
24	VB	I	Alternated video signal input(Blue)	
25	AV <sub>DD</sub>	I	Supply voltage for analog circuit	
26	AV <sub>SS</sub>	-	Ground for analog circuit	

I: Input pin; P: Power pin; G: Ground pin; C: capacitor pin

Note 1: Selection of scanning mode (please refer to the following table)

Setting of scan control input		IN/OUT state for start pulse				Scanning direction
UDC	LRC	STVD	STVU	STHR	STHL	
GND	VCC	OUT	IN	OUT	IN	From up to down, and from left to right.
VCC	GND	IN	OUT	IN	OUT	From down to up, and from right to left.
GND	GND	OUT	IN	IN	OUT	From up to down, and from right to left.
VCC	VCC	IN	OUT	OUT	IN	From down to up, and from left to right.

Note 2: Definition of scanning direction.

Refer to figure as below:

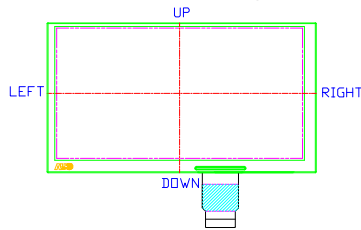

Pin26 Pin1

## 2. Backlight Pin Assignment

Recommended connector : [E&T H201K-P020N-02B](#)

Pin no	Symbol	I/O	Description	Remark
1	VLED	P	LED power supply	
2	GNDLED	P	LED ground	

## 3. Absolute Maximum Ratings

Item	Symbol	Condition	Min.	Max.	Unit	Remark
Power voltage	$V_{CC}$	GND=0	-0.3	7	V	
	$AV_{DD}$	AGND=0	-0.3	7	V	
	$V_{GH}$	GND=0	-0.3	18	V	
	$V_{GL}$		-15	0.3	V	
	$V_{GH} - V_{GL}$		-	33	V	
Input signal voltage	$V_i$		-0.3	$AV_{DD}+0.3$	V	Note 3
	$V_I$		-0.3	$V_{CC}+0.3$	V	Note 4
	VCOM		-2.9	7.5	V	

Note 1: Functional operation should be restricted under ambient temperature (25°C).

Note 2: Maximum ratings are those values beyond which damages to the device may occur. Functional operation should be restricted to the limits in the Electrical Characteristics chapter.

Note 3: VR, VG, VB.

Note 4: STHL, STHR, OEHL, LRC, CPH1~CPH3, STVD, STVU, OEVL, CKV, UDC, MOD



### 3. Electrical DC Characteristics

#### a. Typical Operation Condition (AGND =GND = 0V)

Item		Symbol	Min.	Typ.	Max.	Unit	Remark
Power Voltage		$V_{CC}$	3	3.3	5.5	V	Digital power
		$AV_{DD}$	4.5	5	5.5	V	Analog Power
		$V_{GH}$	14.3	15	15.7	V	Positive power supply for gate driver
		$V_{GL}$	-10.5	-10	-9.5	V	Negative power supply for gate driver
Video signal amplitude (VR, VG, VB)		$V_{iA}$	0.4	-	$AV_{DD}-0.4$	V	Refer to Horizontal timing
		$V_{iAC}$	-	4	-	V	AC component
		$V_{iDC}$	-	$AV_{DD}/2$	-	V	DC component
Input Signal Voltage	H Level	$V_{IH}$	$0.8 \times V_{CC}$	-	$V_{CC}$	V	Note 1.
	L Level	$V_{IL}$	GND	-	$0.2 \times V_{CC}$	V	
Gamma reference voltage		$V_{CAC}$	3.5	5.6	6.5	V	AC component
		$V_{CDC}$	1.38	TBD	1.78	V	DC component

Note 1: STHL, STHR, OEH, LRC, CPH1~CPH3, STVD, STVU, OEV, CKV, UDC, MOD.

Note2: Must follow power On/Off Sequence.

Note 3: If input signal amplitude is 3.3V, recommend value for Vcc is 3.3V

If input signal amplitude is 5V, recommend value for Vcc is 5V

#### b. Current Consumption (AGND=GND=0V)

Parameter	Symbol	Condition	Min.	Typ.	Max.	Unit	Remark
Input current for $V_{GH}$	$I_{GH}$	$V_{GH} = 15V$	-	TBD	1.0	mA	
Input current for $V_{GL}$	$I_{GL}$	$V_{GL} = -10V$	-	TBD	1.0	mA	
Input current for VDINA	$I_{CC}$	$DV_{CC} = 5$	-	TBD	6.0	mA	
Input current for VGH	$I_{DD}$	$AV_{DD} = 5V$	-	TBD	30	mA	

## 4. Electrical AC Characteristics

### a. Signal AC Characteristics

Parameter	Symbol	Min.	Typ.	Max.	Unit.	Remark
Clock cycle time	$t_{CPH}$	100	103	107	ns	CPH1
CPH pulse duty	$t_{CWH}$	40	50	60	%	CPH1
CPH pulse delay	$t_{C12}$		$t_{CPH}/3$	$t_{CPH}/2$	ns	CPH1
STH setup time	$t_{SUH}$	20	-	-	ns	STHR,STHL
STH hold time	$t_{HDH}$	20	-	-	ns	STHR,STHL
STH pulse width	$t_{STH}$	1			$t_{CPH}$	STHR,STHL
STH period	$t_H$	61.8	63.7	66.1	$\mu$ s	STHR,STHL
OEH pulse width	$t_{OEH}$	1	-	-	$t_{CPH}$	OEH (Note 1)
Sample and hold disable time	$t_{DIS1}$	1	-	-	$t_{CPH}$	Note 2
OEV pulse width	$t_{OEV}$	2.0	3.4	6.5	$\mu$ s	OEV
CKV pulse width	$t_{CKV}$	1.0	3.1	4.68	$\mu$ s	CKV
Clean enable time	$t_{DIS2}$	1.0	-	$1 t_{OEV}$	$\mu$ s	Note 3
Horizontal display start	$t_{SH}$	1			$t_{CPH}$	
Horizontal display timing range	$t_{DH}$	480			$t_{CPH}$	
STV setup time	$t_{SUV}$	400	-	-	ns	STVU, STVD
STV hold time	$t_{HDV}$	400	-	-	ns	STVU, STVD
STV pulse width	$t_{STV}$	-	-	1	$t_H$	STVU, STVD
Vertical display start	$t_{SV}$	3			$t_H$	
Vertical display timing range	$t_{DV}$	234			$t_H$	
VCOM rising time	$t_{rCOM}$		-	5	$\mu$ s	
VCOM falling time	$t_{fCOM}$		-	5	$\mu$ s	
VCOM delay time	$t_{DCOM}$	2	-	-	$\mu$ s	
TFT charging time	$t_{ch}$	55	-	-	$\mu$ s	
Output time delay	$t_{del}$	3	-	-	$\mu$ s	
Setup time of analog VR/VG/VB	$t_{asu}$	60	-	-	ns	
Hold time of analog VR/VG/VB	$t_{ahd}$	40	-	-	ns	
Frame rate		50	60	-	Hz	

Note 1: The maximum pulse width of OEH should refer to the minimum of  $t_{DIS1}$  and the hsync back porch.

Note 2:  $t_{DIS1}$  is time difference between OEH and STHL.

Note 3:  $t_{DIS2}$  is time difference between OEV and CKV

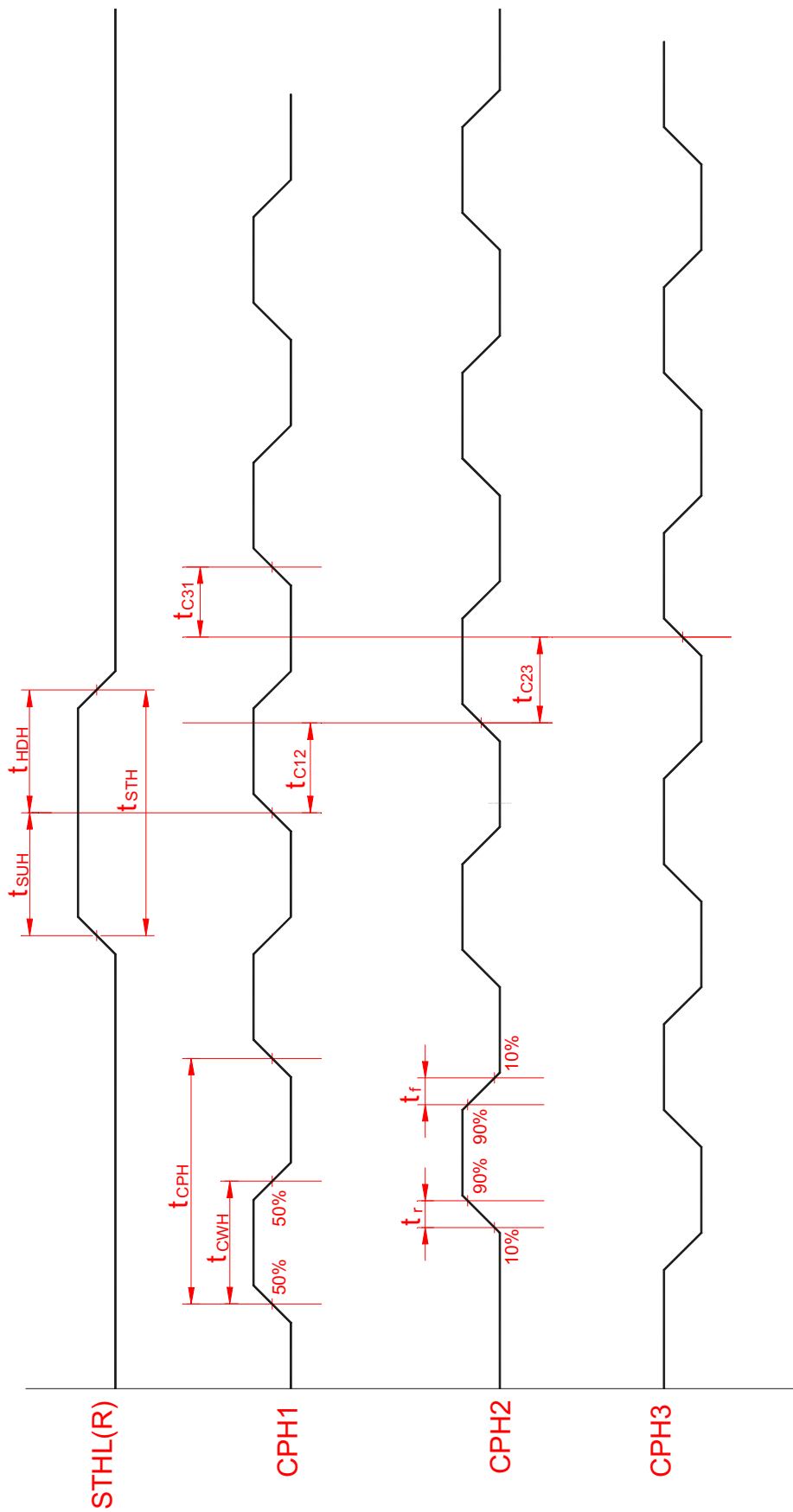

Sampling clock timing

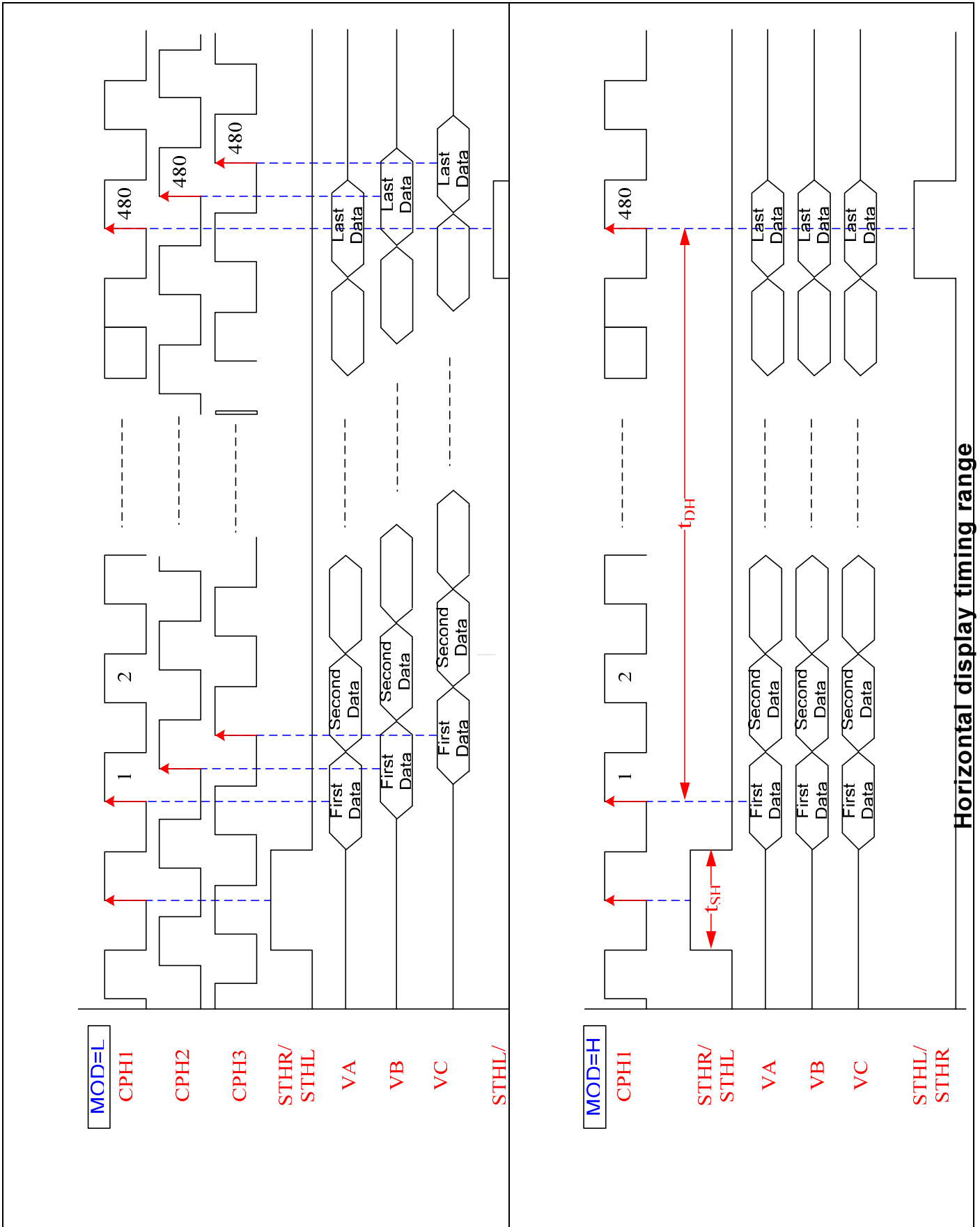
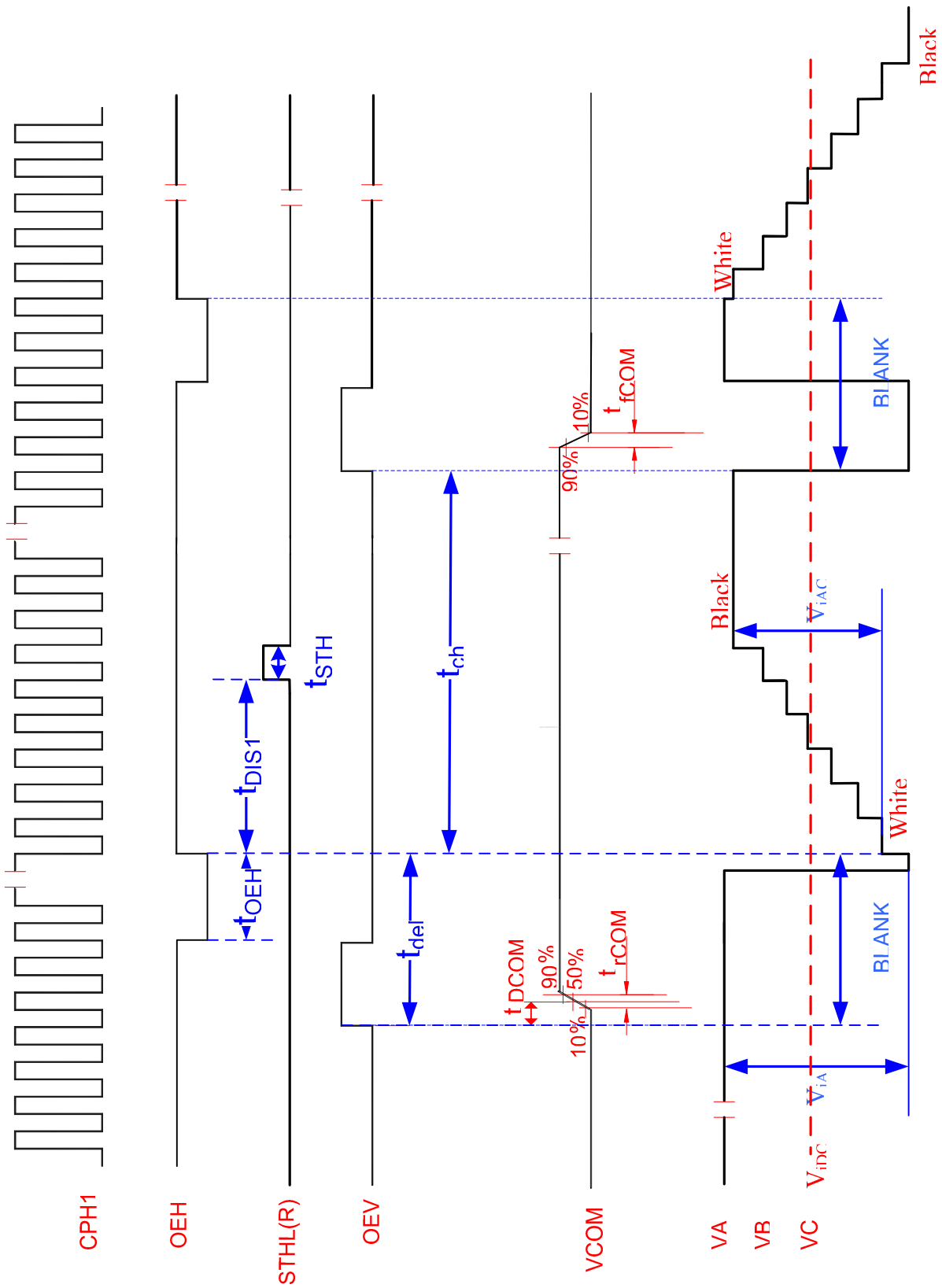
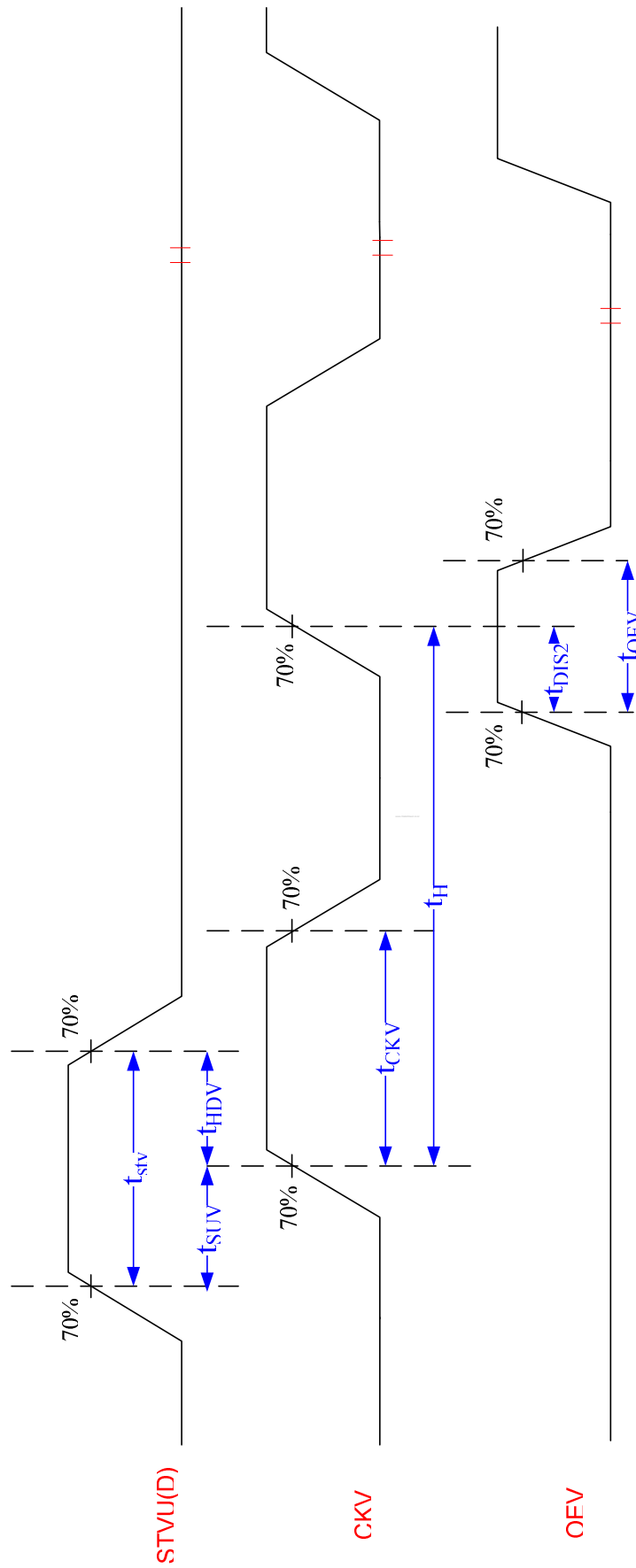

Fig. 8 Select clock signal on latching B, C, B signals



Horizontal timing



Vertical shift clock timing

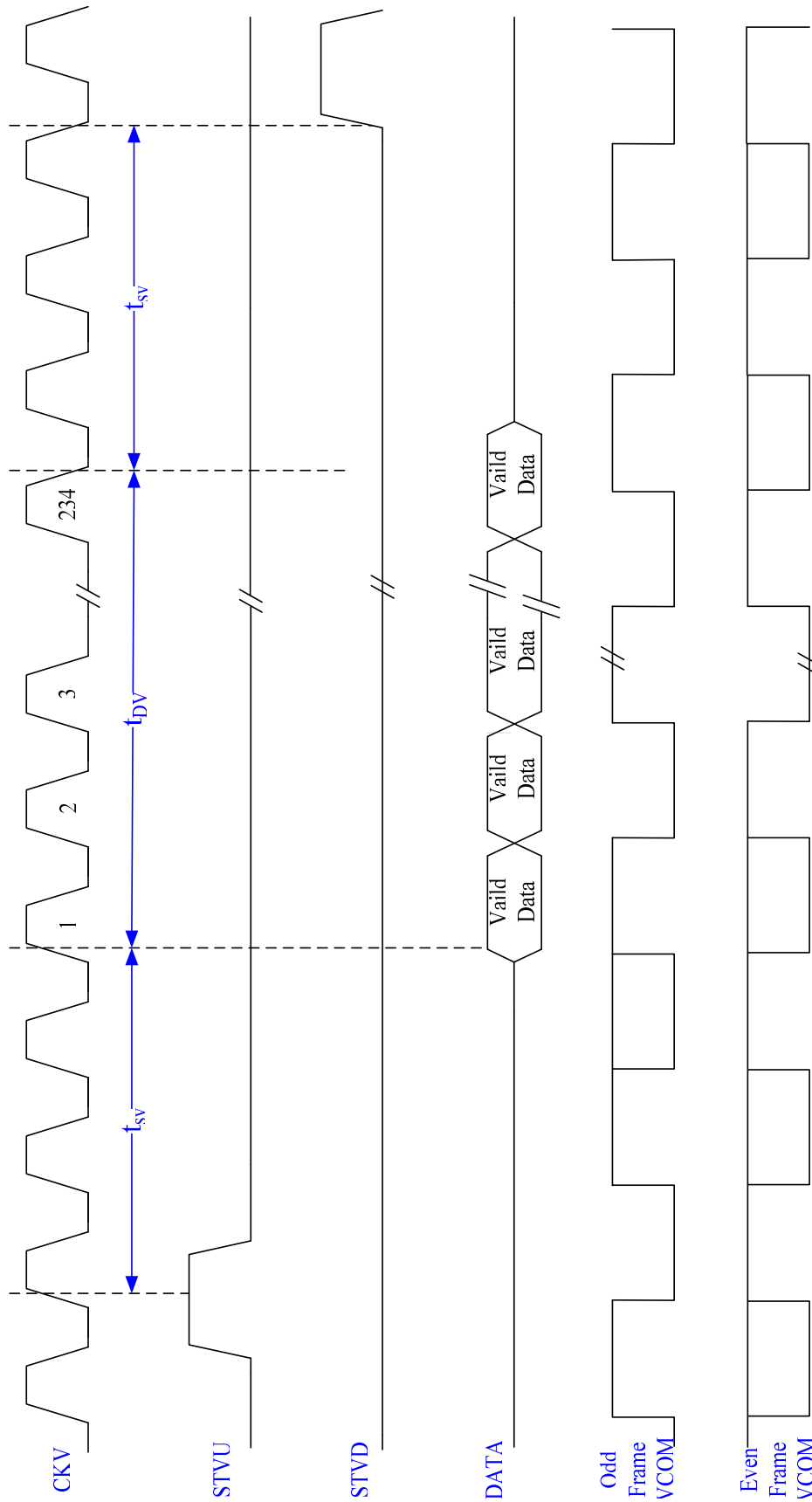

**Vertical timing (From up to down)**

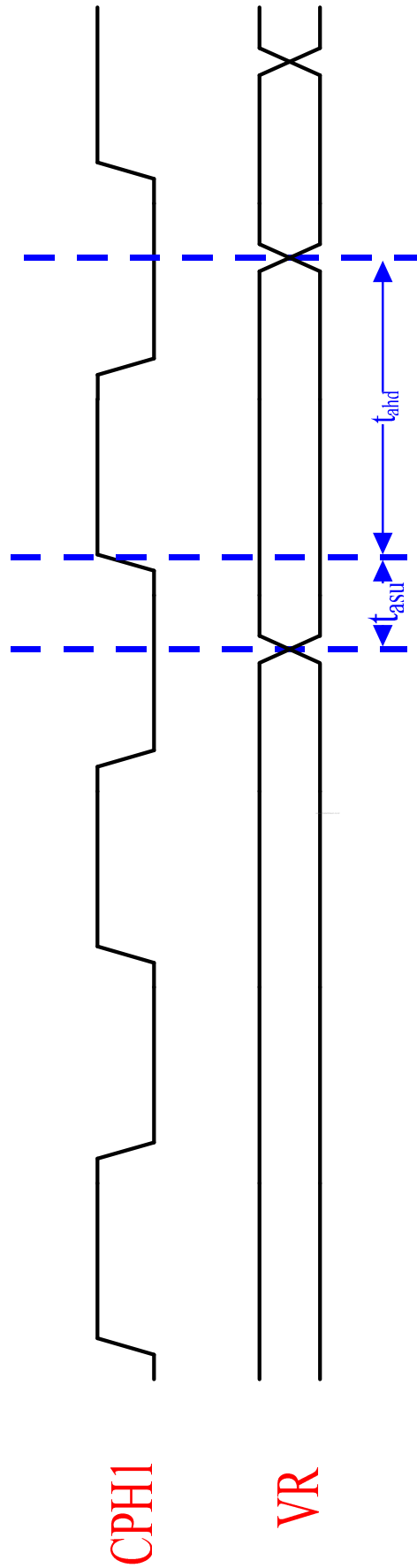

The setup and hold time definition between CPH1 and analog signal VR



### 6. Power On/Off Characteristics

#### Power On

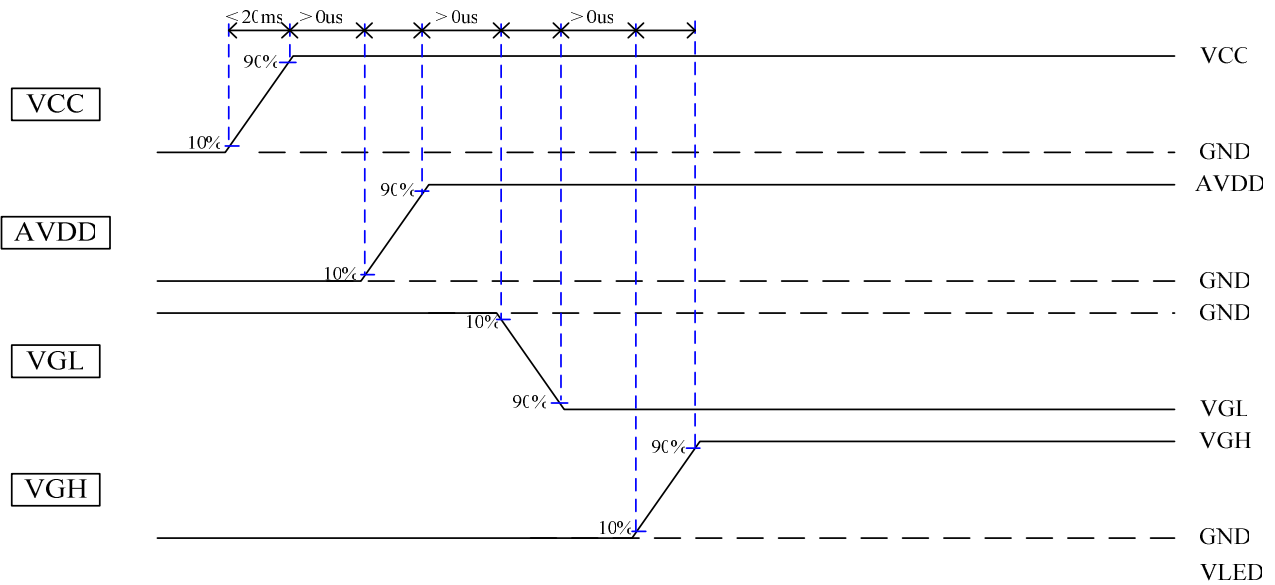

#### Power Off

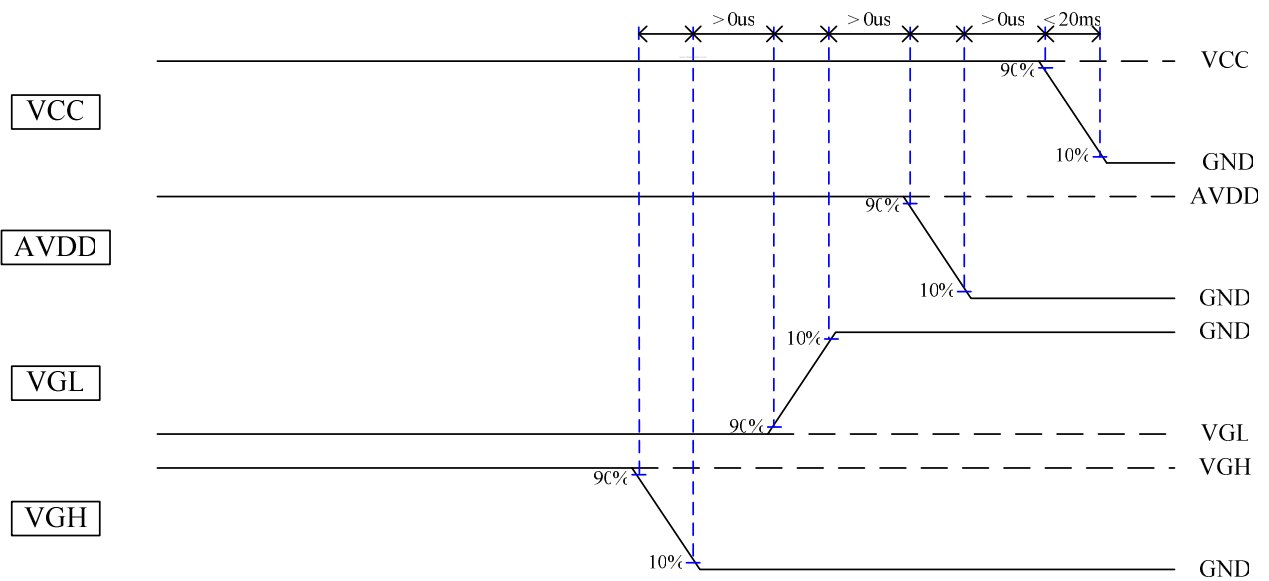

## D. Optical Specification

All optical specification is measured under typical condition (Note 1, 2)

Item	Symbol	Condition	Min.	Typ.	Max.	Unit	Remark
Response Time							
Rise	Tr	$\theta=0^\circ$	--	4	24	ms	Note 3
Fall	Tf		--	12	36	ms	
Contrast ratio	CR	At optimized viewing angle	300	400	--		Note 4
Viewing Angle		$CR \geq 10$					deg. Note 5
Top			30	40	--		
Bottom			50	65	--		
Left			50	65	--		
Right		50	65	--			
Transmission	$Y_L$	$\theta=0^\circ$	7.5-	8.0	--	%	Note 6
White chromaticity shift	X	$\theta=0^\circ$	-0.03-	--	0.03		Note 7
	Y	$\theta=0^\circ$	0	--	0.06		

Note 1: Ambient temperature =25°C, and LED lightbar current  $I_L = 150$  mA. To be measured in the dark room.

Note 2: To be measured on the center area of panel with a viewing cone of  $1^\circ$  by Topcon luminance meter BM-5A, after 15 minutes operation.

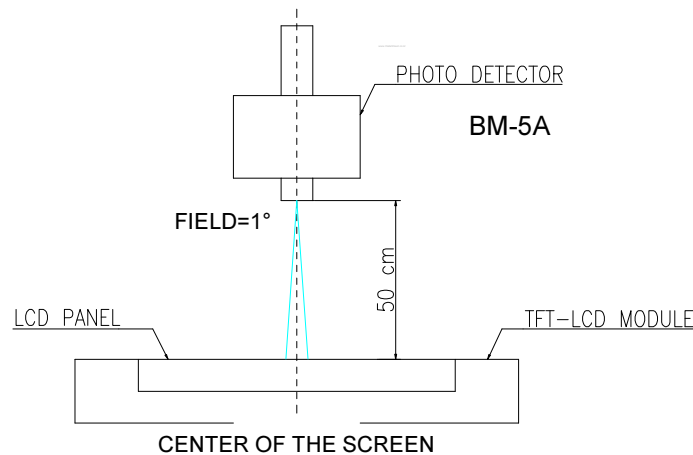

Note 3: Definition of response time:

The output signals of photo detector are measured when the input signals are changed from "black" to "white"(falling time) and from "white" to "black"(rising time), respectively.

The response time is defined as the time interval between the 10% and 90% of amplitudes.

Refer to figure as below.

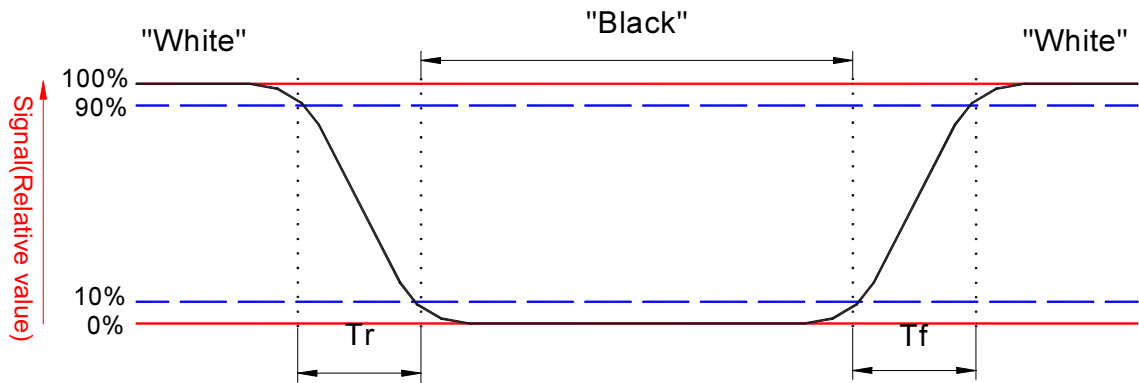

Note 4. Definition of contrast ratio:

Contrast ratio is calculated with the following formula.

$$\text{Contrast ratio (CR)} = \frac{\text{Photo detector output when LCD is at "White" status}}{\text{Photo detector output when LCD is at "Black" status}}$$

Note 5. Definition of viewing angle,  $\theta$ , Refer to figure as below.

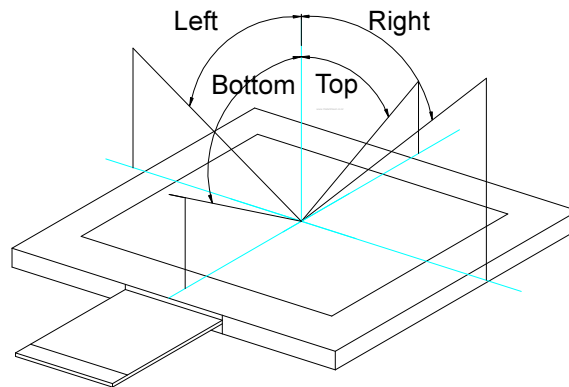

Note 6. Measured at the center area of the panel when all the input terminals of LCD panel are electrically opened.

Note 7: Chromaticity shift is the difference of those of the light source and the panel place on it.

## E. Reliability Test Items

No.	Test items	Conditions	Remark
1	High Temperature Storage	Ta= 70°C      240Hrs	
2	Low Temperature Storage	Ta= -20°C      240Hrs	
3	High Ttemperature Operation	Tp= 60°C      240Hrs	
4	Low Temperature Operation	Ta= -10°C      240Hrs	
5	High Temperature & High Humidity	Tp= 50°C . 80% RH      240Hrs	Operation
6	Heat Shock	-10°C/0.5hr~60°C/0.5hr, 50 cycle	Non-operation
7	Electrostatic Discharge	Contact = ± 4 kV, class B Air = ± 8 kV, class B	Note 4
8	Image Sticking	25°C, 4hrs	Note 5
9	Vibration	Frequency range : 10~55Hz Stoke : 1.5mm Sweep : 10 Hz ~55 Hz 2 hours for each direction of X,Y,Z 4 hours for Y direction	Non-operation JIS C7021, A-10 condition A : 15 minutes
10	Mechanical Shock	— 100G . 6ms, ±X,±Y,±Z 3 times for each direction	Non-operation JIS C7021, A-7 condition C
11	Vibration (With Carton)	Random vibration: 0.015G <sup>2</sup> /Hz from 5~200Hz -6dB/Octave from 200~500Hz	IEC 68-34
12	Drop (With Carton)	Height: 100cm 1 corner, 3 edges, 6 surfaces	

Note 1: Ta: Ambient Temperature. Tp: Panel Surface Temperature

Note 2: In the standard conditions, there is not display function NG issue occurred. All the cosmetic specification is judged before the reliability stress.

Note 3: All the cosmetic specification is judged before the reliability stress.

Note 4 : All test techniques follow IEC6100-4-2 standard.

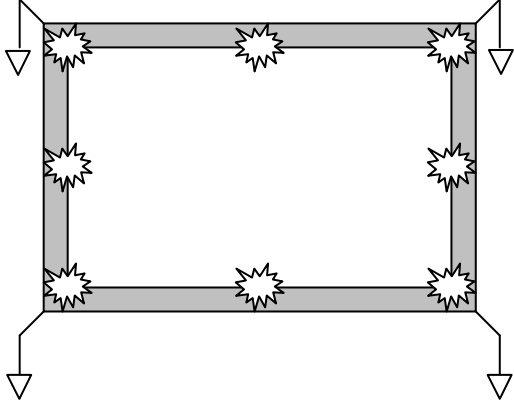
Test Condition		Note
<b>Pattern</b>		
<b>Procedure And Set-up</b>	<p> <u>Contact Discharge</u> : 330Ω, 150pF, 1sec, 8 point, 25times/point  <u>Air Discharge</u> : 330Ω, 150pF, 1sec, 8 point, 25times/point                 </p> 	
<b>Criteria</b>	B – Some performance degradation allowed. No data lost. Self-recoverable hardware failure.	
<b>Others</b>	1. Gun to Panel Distance 2. No SPI command, keep default register settings.	

Note 5: Operate with 5 x 5 chess board pattern as figure and light on 4 hrs. Then modify to 32 degree gray pattern. After 20 minutes, the mura is less than JND 2.5

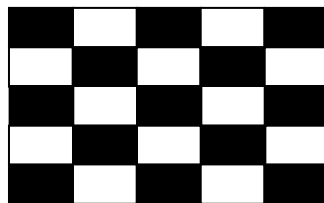

## F. Packing and Marking

### 1. Packing Form

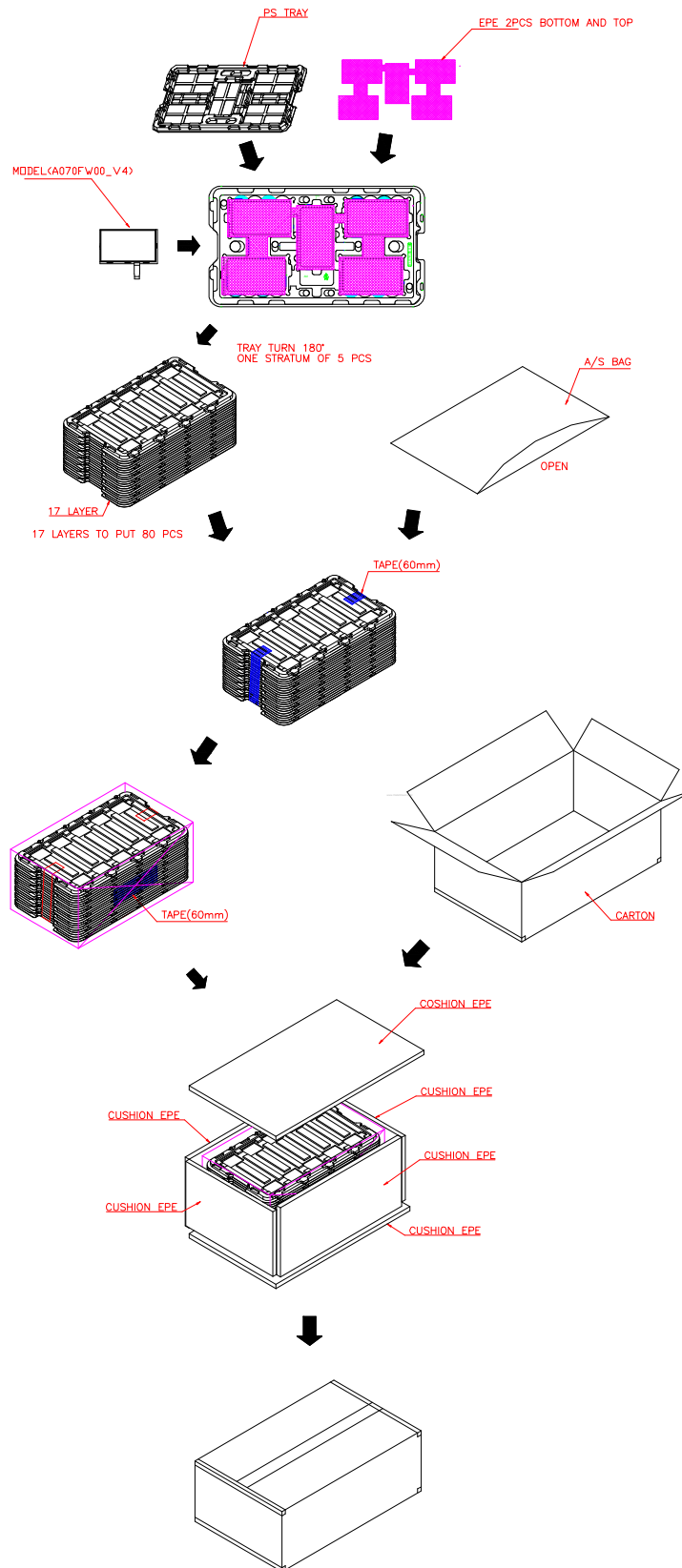

MAX. CAPACITY:80 MODULES  
MAX. WEIGHT:10kg  
MEAS. 600mmX353mmX210mm

## 2. Module/Panel Label Information

The module/panel (collectively called as the "Product") will be attached with a label of Shipping Number which represents the identification of the Product at a specific location. Refer to the Product outline drawing for detailed location and size of the label. The label is composed of a 22-digit serial number and printed with code 128 with the following definition:

### ABCDEFGHIJKLMNQRSTUY

- For internal system usage and production serial numbers.
- AUO Module or Panel factory code, represents the final production factory to complete the Product
- Product version code, ranging from 0~9 or A~Z (for Version after 9)
- Week Code, the production week when the product is finished at its production process

Example:

501M06ZL06123456781Z05:

Product Manufacturing Week Code: WK50

Product Version: Version 1

Product Manufacturing Factory: M06

## 3. Carton Label Information

The packing carton will be attached with a carton label where packing Q'ty, AUO Model Name, AUO Part Number, Customer Part Number (Optional) and a series of Carton Number in 13 or 14 digits are printed. The Carton Number is appearing in the following format:

### ABC-DEFG-HIJK-LMN

- DEFG appear after first "-" represents the packing date of the carton
- Date from 01 to 31
- Month, ranging from 1~9, A~C. A for Oct, B for Nov and C for Dec.
- A.D. year, ranging from 1~9 and 0. The single digit code represents the last number of the year

Refer to the drawing of packing format for the location and size of the carton label.

## G. Precautions

1. Do not twist or bend the module and prevent the unsuitable external force for display module during assembly.
2. Adopt measures for good heat radiation. Be sure to use the module with in the specified temperature.
3. Avoid dust or oil mist during assembly.
4. Follow the correct power sequence while operating. Do not apply the invalid signal, otherwise, it will cause improper shut down and damage the module.
5. Less EMI: it will be more safety and less noise.
6. Please operate module in suitable temperature. The response time & brightness will drift by different temperature.
7. Avoid to display the fixed pattern (exclude the white pattern) in a long period, otherwise, it will cause image sticking.
8. Be sure to turn off the power when connecting or disconnecting the circuit.
9. Polarizer scratches easily, please handle it carefully.
10. Display surface never likes dirt or stains.
11. A dewdrop may lead to destruction. Please wipe off any moisture before using module.
12. Sudden temperature changes cause condensation, and it will cause polarizer damaged.
13. High temperature and humidity may degrade performance. Please do not expose the module to the direct sunlight and so on.
14. Acetic acid or chlorine compounds are not friends with TFT display module.
15. Static electricity will damage the module, please do not touch the module without any grounded device.
16. Do not disassemble and reassemble the module by self.
17. Be careful do not touch the rear side directly.
18. No strong vibration or shock. It will cause module broken.
19. Storage the modules in suitable environment with regular packing.
20. Be careful of injury from a broken display module.
21. Please avoid the pressure adding to the surface (front or rear side) of modules, because it will cause the display non-uniformity or other function issue.