



Version	1
Total pages	24
Date	2008/7/25

# Product Specification

## 10.1" color TFT-LCD module

MODEL NAME: A101VW01 V3

- (  ) Preliminary Specification
- (  ) Final Specification

Note: The content of this specification is subject to change.

© 2008 AU Optronics  
All Rights Reserved,  
Do Not Copy.





**Contents:**

- A. Physical specification..... P3**
- B. Electrical specifications..... P4**
  - 1. Pin Assignment..... P4
  - 2. Absolute maximum ratings..... P7
  - 3. Electrical characteristics ..... P7
    - a. Typical operating conditions (GND=AVSS=0V)..... P7
    - b. Current consumption conditions ..... P8
    - c. Backlight driving conditions. .... P8
  - 4. AC Timing..... P9
    - a. Digital Signal AC Characteristic..... P9
    - b. Operation Mode ..... P10
    - c. Horizontal timing..... P11
    - d. Vertical shift timing..... P12
    - e. Vertical timing ..... P13
- C. Optical specifications..... P14**
- D. Reliability test items..... P16**
- E. Packing form..... P17**



**Appendix:**

Fig.1 Outline dimension of TFT-LCD module (Front Side)	<b>P18</b>
Fig.2 Outline dimension of TFT-LCD module (Rear Side)	<b>P19</b>
Fig.3 Power On sequence	<b>P20</b>
Fig.4 Power Off sequence	<b>P21</b>
Fig.5 Reference Gamma Voltage	<b>P22</b>

### A. Physical specifications

NO.	Item	Specification	Remark
1	Display resolution (dot)	800 RGB (W) x 480(H)	
2	Active area (mm)	219.6(W) x 131.76(H)	
3	Screen size (inch)	10.1(Diagonal)	
4	Pixel pitch (mm)	0.2745(W) x 0.2745(H)	
5	Color configuration	R. G. B. stripe	Note 1
6	Overall dimension (mm)	235(W) x 145.9(H) x 5.4(D)	Note 2
7	Weight (g)	315g	
8	Surface treatment	Anti-Glare	
9	Backlight unit	LED(33pcs)	

Note 1: Below figure shows the dot stripe arrangement.

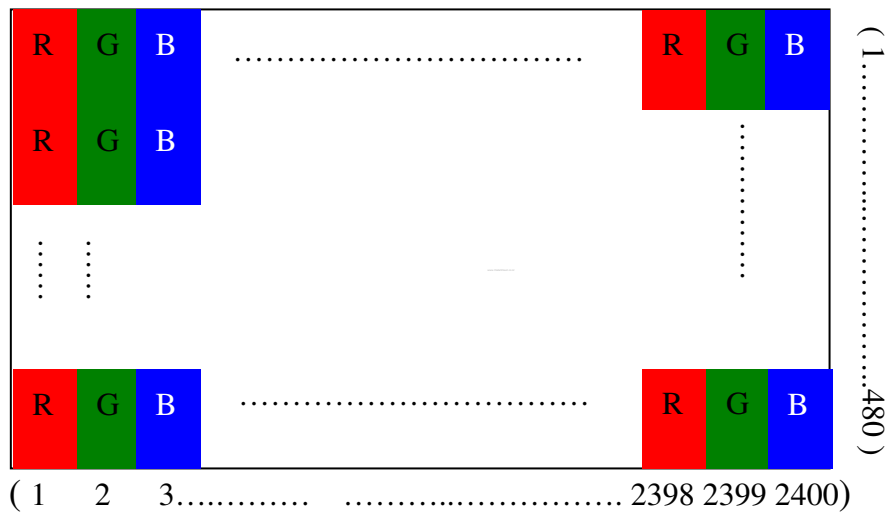

Note 2: Refer to Fig.1 and Fig.2

## B. Electrical specifications

### 1. Pin assignment (suggest connector - Hirose FH12-30S-0.5SH)

Pin no	Symbol	I/O	Description	Remark
1	POL	I	Polarity selection	Note 3
2	STVD	I/O	Vertical start pulse signal input or output	Note 1
3	OE	I	Outputs enable. Active low. The gate driver outputs are disable when OEV = "H".	
4	CKV	I	Vertical clock	
5	STVU	I/O	Vertical start pulse signal input or output	Note 1
6	GND	P	Power ground	
7	EDGSL	I	Select raising edge or raising/falling edge When EDGSL = "0", Latching source data onto the line latches at the rising edge. When EDGSL = "1", Latching source data onto the line latches at the rising edge and falling edge.	Page 9.10
8	VCC	P	Digital voltage for source driver	
9	V9	I	Gamma voltage level 9	
10	VGL	P	TFT low voltage	
11	V2	I	Gamma voltage level 2	
12	VGH	P	TFT high voltage	
13	V6	I	Gamma voltage level 6	
14	U/D	I	Up/down selection	Note 1
15	VCOM	I	Common voltage	
16	GND	P	Power ground	
17	AVDD	P	Analog voltage	
18	V14	I	Gamma voltage level 14	
19	V11	I	Gamma voltage level 11	
20	V8	I	Gamma voltage level 8	
21	V5	I	Gamma voltage level 5	
22	V3	I	Gamma voltage level 3	
23	GND	P	Power ground	
24	R5	I	Red data(MSB)	
25	R4	I	Red data	
26	R3	I	Red data	
27	R2	I	Red data	
28	R1	I	Red data	
29	R0	I	Red data(LSB)	
30	GND	P	Power ground	

Pin no	Symbol	I/O	Description	Remark
31	GND	P	Power ground	
32	G5	I	Green data (MSB)	
33	G4	I	Green data	
34	G3	I	Green data	
35	G2	I	Green data	
36	G1	I	Green data	
37	G0	I	Green data (LSB)	
38	DIO2	I/O	Horizontal start pulse signal input or output	<b>Note 1</b>
39	INV	I	Control Whether RGB data are inverted or not When "INV" = 1 these data will be inverted. Ex. "00"→"3F", "07"→"38", and so on.	
40	GND	P	Power ground	
41	DCLK	I	Pixel clock	
42	VCC	P	Voltage for digital circuit	
43	DIO1	I/O	Horizontal start pulse signal input or output	Note 1
44	LD	I	Latches the polarity of outputs and switches the new data to outputs	Note 2
45	B5	I	Blue data (MSB)	
46	B4	I	Blue data	
47	B3	I	Blue data	
48	B2	I	Blue data	
49	B1	I	Blue data	
50	B0	I	Blue data (LSB)	
51	R/L	I	Right/ left selection	<b>Note 1</b>
52	V1	I	Gamma voltage level 1	
53	V4	I	Gamma voltage level 4	
54	V7	I	Gamma voltage level 7	
55	V10	I	Gamma voltage level 10	
56	V12	I	Gamma voltage level 12	
57	V13	I	Gamma voltage level 13	
58	AVDD	P	Analog voltage	
59	GND	P	Power ground	
60	VCOM	I	Common voltage	

□I: Input. O: Output. P: Power.

Note 1:

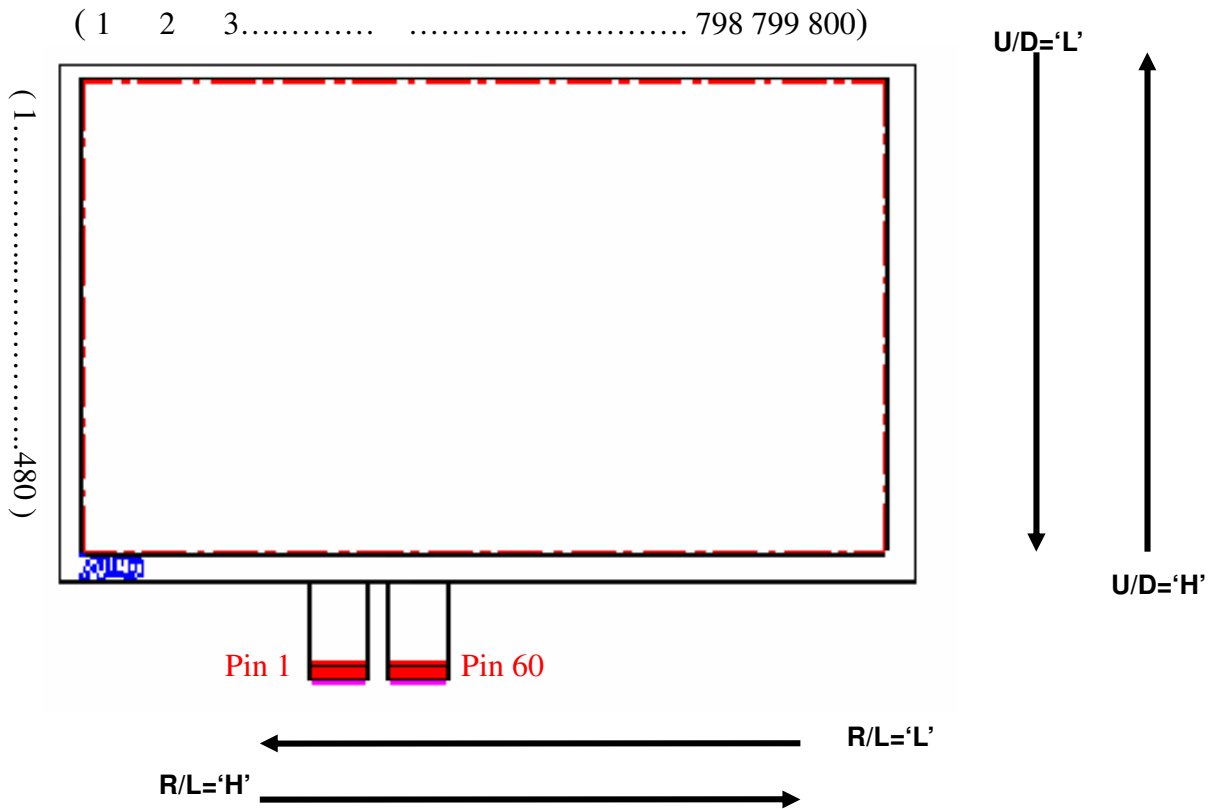

U/D	STVU	STVD	Direction
L	Input	Output	U→D
H	Output	Input	D→U

R/L	DIO1	DIO2	Direction
H	Input	Output	L→R
L	Output	Input	R→L

Note 2: LD

Latches the polarity of outputs and switches the new data to outputs.

1. At the rising edge, latches the “POL” signal to control the polarity of the outputs.
2. The pin also controls the switch of the line registers that switches the new incoming data to outputs.

Note 3: POL

“POL” value is latched at the rising edge of “LD” to control the polarity of the even or odd outputs.

POL=1: Even outputs range from V1 ~ V7, and Odd outputs range from V8 ~ V14

POL=0: Even outputs range from V8 ~ V14, and Odd outputs range from V1 ~ V7



## 2. Absolute Maximum Ratings

Items	Symbol	Product Specification			Unit	Remark
		Min.	Typ.	Max.		
Power Voltage	VCC	-0.5		5	V	Pin8.42
	AVDD	-0.5		12	V	Pin17.58
	VGH	-0.3		18	V	Pin12
	VGL	-15		0.3	V	Pin10
	VGH-VGL			33	V	
Input Signal Voltage	Vi	-0.3		VCC+0.3	V	Note 1
	Vref(V1~V7)	0.4AVDD		AVDD+0.3	V	
	Vref(V8~V14)	-0.3		0.6AVDD	V	
	VCOM	3.27		3.89	V	Pin15.60
Operating Temperature	Topa	-30		85	°C	
Storage Temperature	Tstg	-40		85	°C	

Note 1: Vi denotes digital input signal voltage (Pins 1~5, 7, 14, 24~29, 32~37, 38, 39, 41, 43, 44, and 45~51).

Note 2: Stresses above those listed under "Absolute Maximum Rating" may cause permanent damage to the device. These are stress ratings only. Functional operation of this device at these or any other conditions above those indicated in the operational sections of this specification is not implied and exposure to absolute maximum rating conditions for extended periods may affect device reliability.

## 3. Electrical characteristics

### a. Typical operating conditions (GND=AVSS=0V)

Items	Symbol	Product Specification			Unit	Remark
		Min.	Typ.	Max.		
Power Voltage	VCC	3.0	3.3	3.6	V	Pin8.42
	AVDD	8.4	8.8	9.2	V	Pin17.58
	VGH	14	15	16	V	Pin12
	VCOM	3.5	3.7	3.9	V	Note, Pin15.60
	VGL	-6.8	-7.0	-7.2	V	Pin10
Input Reference Voltage	V1~V7	0.4AVDD	—	AVDD-0.3	V	
	V8~V14	0.1	—	0.6AVDD	V	
Input H/L level Voltage	VIH	0.7VCC	—	VCC	V	
	VIL	0	—	0.3VCC	V	

Note: The VCOM voltage is determined based on gamma 2.2 (the reference gamma circuit is shown in appendix fig.5). VCOM should be adjusted to minimize LCM display flicker.

**b. Current consumption conditions (GND=AVSS=0V)**

Parameter	Symbol	Condition	Min.	Typ.	Max.	Unit	Remark
Current For Driver	IGH	VGH=15V		231	242	uA	--
	IGL	VGL=-7V		-244	-256	uA	--
	ICC	VCC=3.3V		3.0	5.0	mA	--
	IDD	AVDD=8.8V		32.5	35.0	mA	--

Note: Test Condition: 8colorbar+Grayscale pattern, DE mode, DCLK=33MHz, Frame rate: 60Hz.

**c. Backlight electrical characteristics**

Item		Symbol	Condition	Min	Typ	Max	Unit
Forward Voltage	Main Side	$V_F$	$I_F=220(\text{mA})^*$		12		V
	Sub Side ■NA						
Forward Current	Main Side	$I_F$	at 25□		220		mA
	Sub Side ■NA						
LED Lifetime		$L_L$	at 25□	20,000			Hr

Note 1: LED backlight is 3 series in 11 parallel connection types.

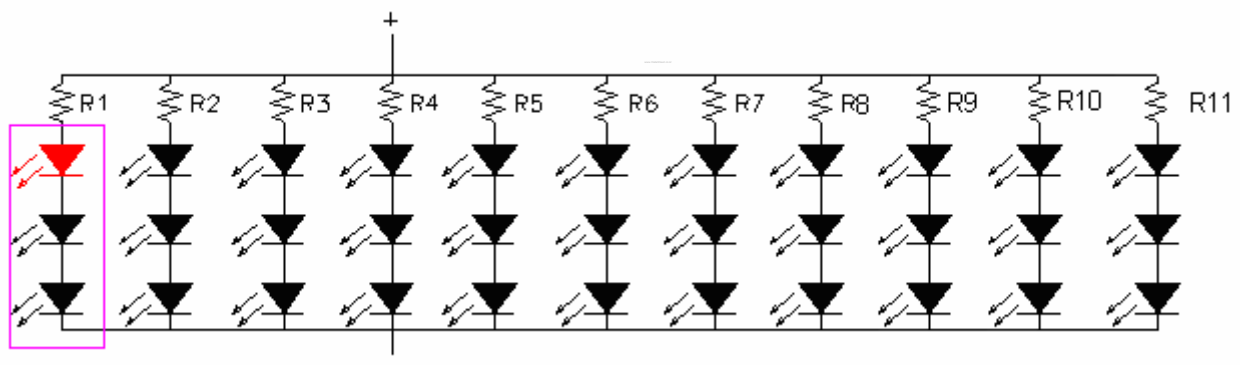

Note 2: Define "LED Lifetime": brightness is decreased to 50% of the initial value.

LED Lifetime is restricted under normal condition, ambient temperature = 25□



#### 4. AC Timing

##### a. Digital Signal AC Characteristic

Conditions: (VCC=3.3V, AVDD=8.4V, AVSS=GND=0V, TA=25°C)

Parameter	Symbol	Min.	Typ.	Max.	Unit
DCLK frequency (EDGSL = '0')	Fclk		33	44	MHz
DCLK frequency (EDGSL = '1')	Fclk		16.5	22	MHz
DCLK cycle time	Tcph	22.8	30		ns
DCLK pulse width	Tcw	40%		60%	Tcph
Data set-up time	Tsu	4			ns
Data hold time	Thd	2			ns
Propagation delay of DIO2/1	Tphl	6	10	15	ns
Time that the last data to LD	Tld	1			Tcph
Pulse width of LD	Twld	2			Tcph
Time that LD to DIO1/2	Tlds	5			Tcph
POL set-up time	Tpsu	6			ns
POL hold time	Tphd	6			ns
STV setup time	Tsuv	200			ns
STV hold time	Thdv	300			ns
CKV pulse width	Tckv	500			ns
Output stable time	Tst			15	us

**b. Operation Mode 1**

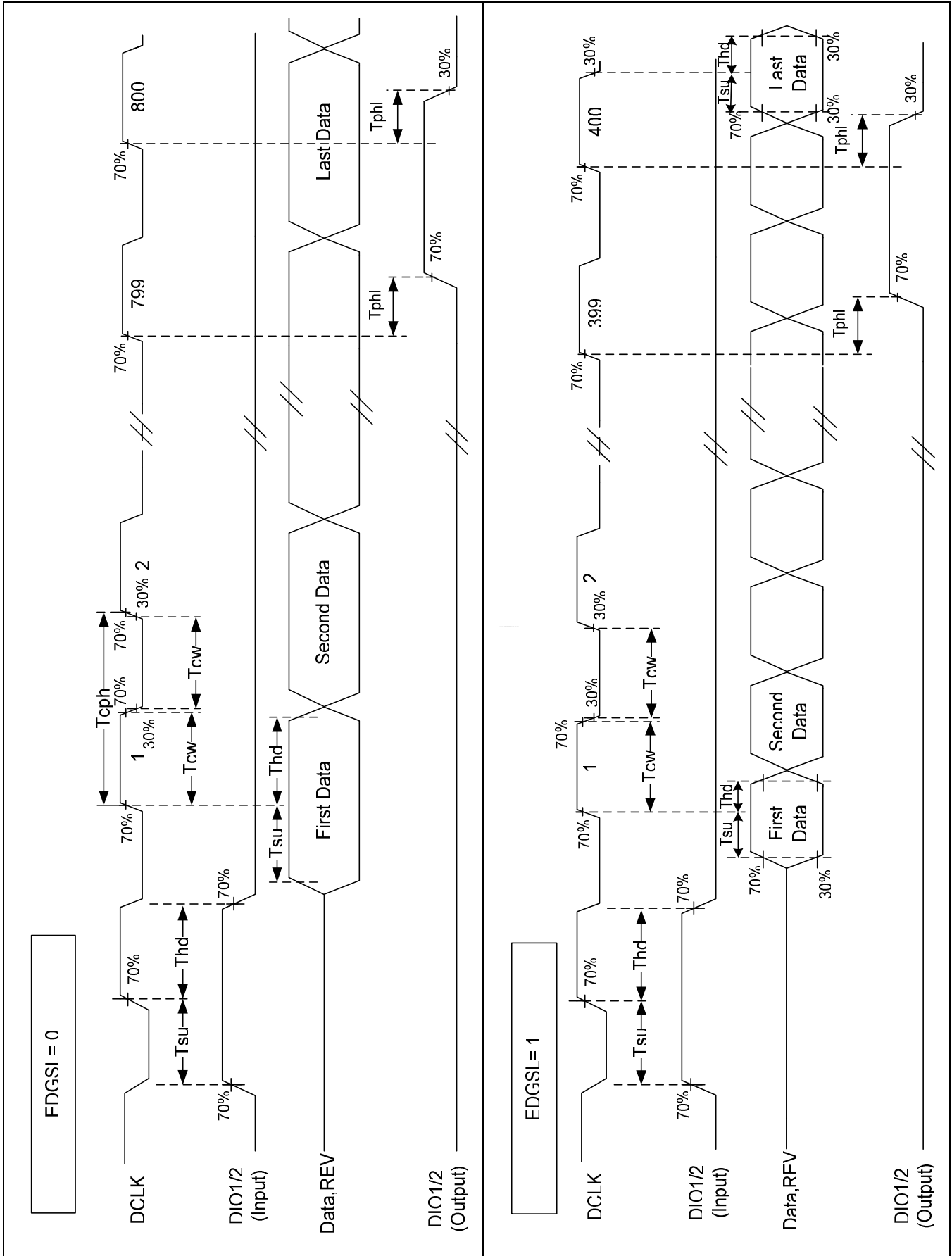

c. Horizontal timing

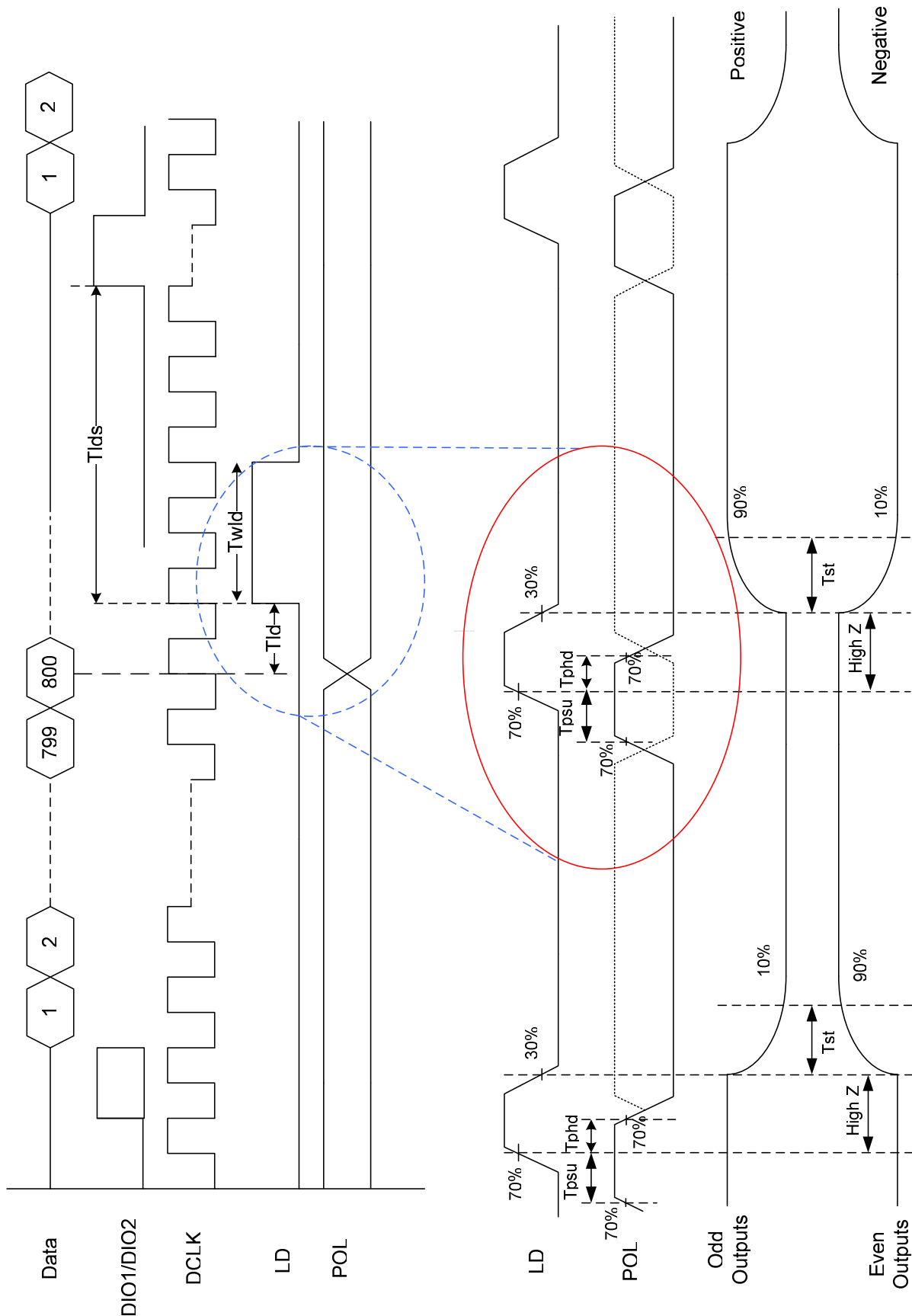

## d. Vertical shift timing

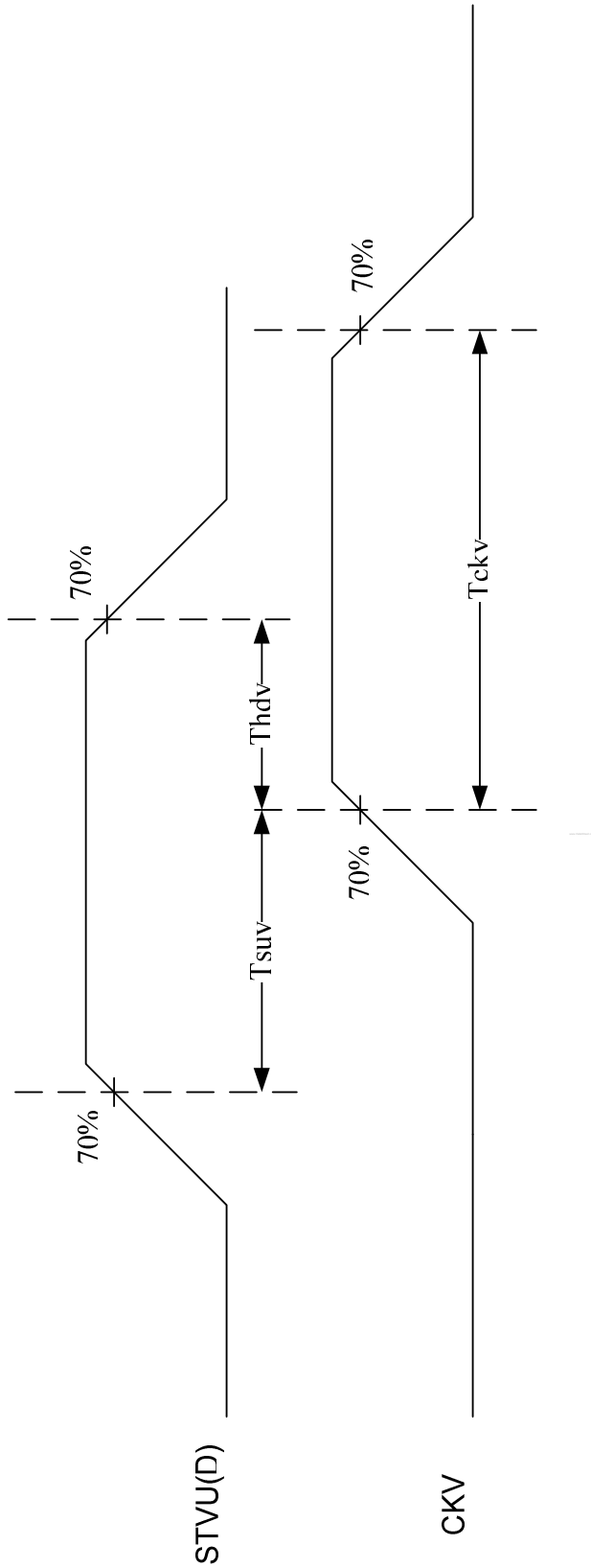

e. Vertical timing

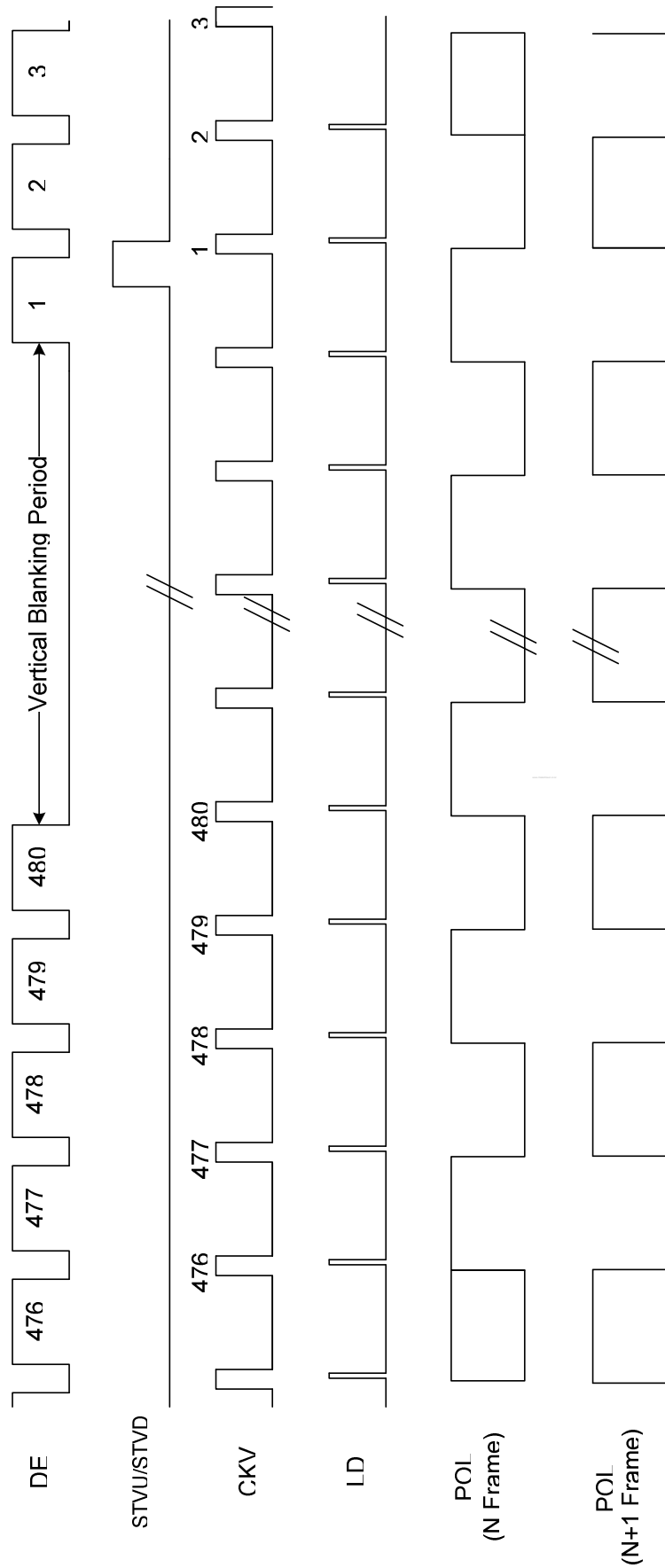

\* During vertical blanking period, still have LD & CKV & POL pulse

### C. Optical specification (Note 1, Note 2)

Item	Symbol	Condition	Min.	Typ.	Max.	Unit	Remark
Response time	Rise	$\theta = 0^\circ$	-	12	24	ms	Note 3,5
	Fall		-	18	36	ms	
Contrast ratio	CR	At optimized Viewing angle	250	400	-		Note 4, 5
Viewing angle	Top	$CR \geq 10$	40	<b>45</b>	-	deg.	Note 5, 6
	Bottom		55	<b>65</b>	-		
	Left		55	<b>65</b>	-		
	Right		55	<b>65</b>	-		
Brightness	$Y_L$	$V=12V, 25\%$	<b>200</b>	<b>250</b>	-	$cd/m^2$	Note 7
Luminance Uniformity			70	75	-	%	Note 8
White chromaticity	X	$\theta=0^\circ$	0.26	0.31	0.36		Note 7
	Y	$\theta=0^\circ$	0.28	0.33	0.38		

Note 1 : Ambient temperature  $\approx 25^\circ C$ , and lamp current  $I_L = 6.5$  mA rms. To be measured in the dark room. DC/AC inverter driving frequency: 60 kHz.

Note 2 : To be measured on the center area of panel with a viewing cone of  $1^\circ$  by Topcon luminance meter BM-5, after 10 minutes operation.

Note 3. Definition of response time:

The output signals of photo detector are measured when the input signals are changed from "black" to "white" (falling time) and from "white" to "black" (rising time), respectively. The response time is defined as the time interval between the 10% and 90% of amplitudes. Refer to figure as below.

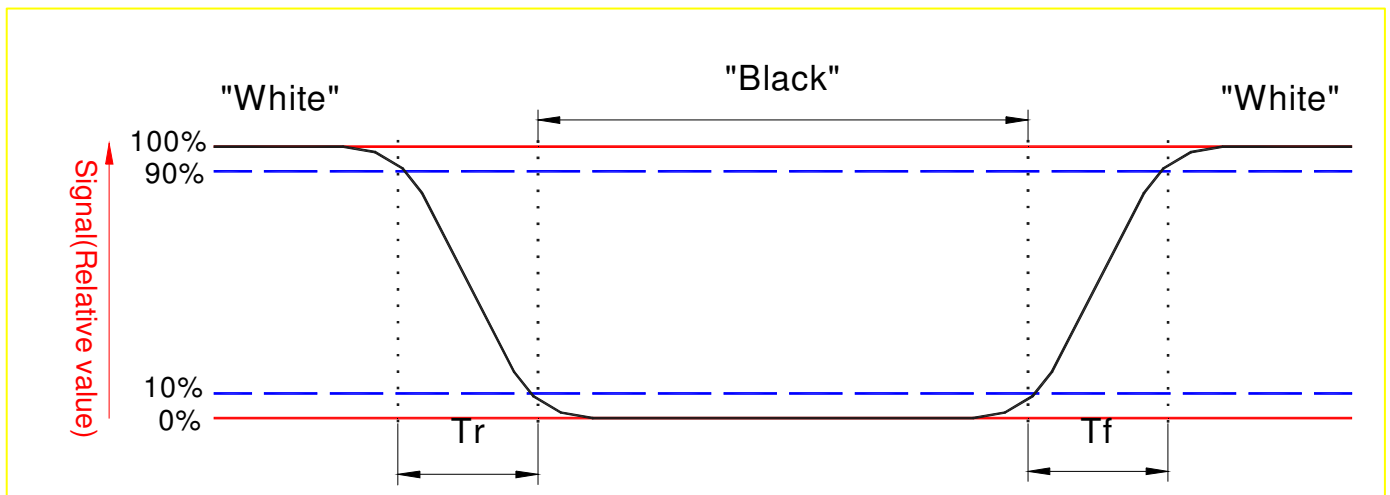

Note 4. Definition of contrast ratio:

Contrast ratio is calculated with the following formula.

$$\text{Contrast ratio (CR)} = \frac{\text{Photo detector output when LCD is at "White" state}}{\text{Photo detector output when LCD is at "Black" state}}$$

Note 5. The 100% transmission is defined as the transmission of LCD panel when all the input



terminals of module are electrically opened.

Note 6. Definition of viewing angle. Refer to figure as below.

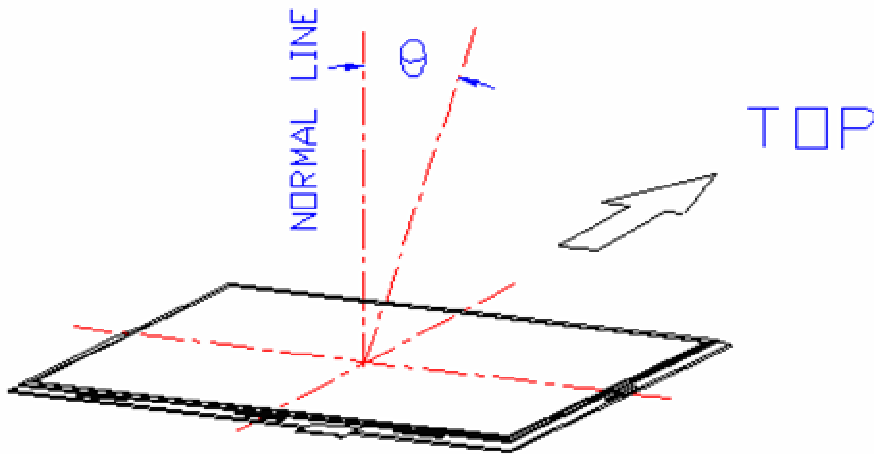

Note 7. Transmission is defined as follow: ( $\theta = 0^\circ$ )

$$\text{Transmission} = B1/B2$$

B1=Photo detector output voltage when measuring the brightness of the LCD panel

Placed on the light source with no applied voltage

B2=Photo detector output voltage when measuring the light source.

Note 8. Luminance Uniformity of these 9 points is defined as below:

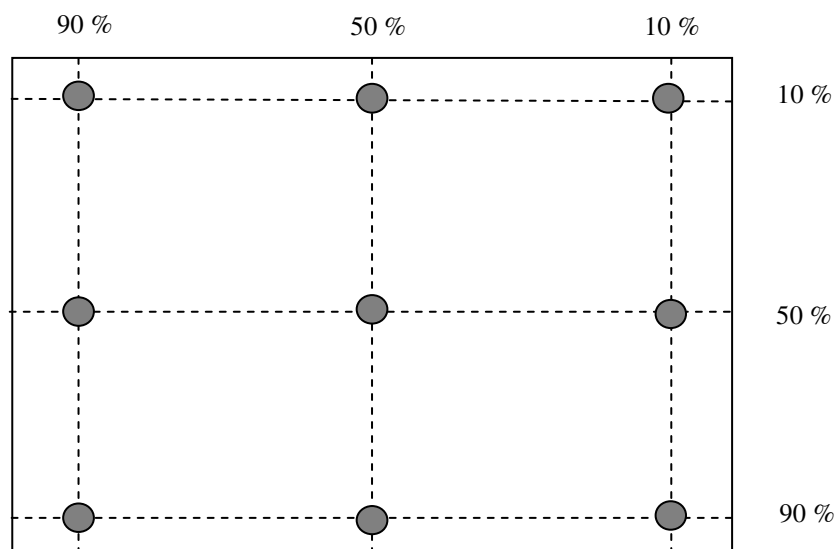

**D. Reliability test items (Note 2):**

No.	Test items	Conditions	Remark
1	High temperature storage	Ta= 70°C      240Hrs	
2	Low temperature storage	Ta= -20°C      240Hrs	
3	High temperature operation	Tp= 60°C      240Hrs	
4	Low temperature operation	Ta= -10°C      240Hrs	
5	High temperature and high humidity	Tp= 50°C, 80% RH      240Hrs	Operation
6	Thermal shock	-30°C~70°C/ 100 cycles 1Hrs/cycle	Non-operatio
7	Electrostatic discharge	±200V,200pF(0Ω), once for each terminal	Non-operatio
8	Vibration	Frequency range : 8~33.3Hz Stoke : 1.3mm Sweep : 2.9G, 33.3 ~ Cycle : 15 minutes 2 hours for each direction of X,Z 4 hours for Y direction	JIS D1601, A-10 Condition A
9	Mechanical shock	100G, 6ms, ±X,±Y,±Z 3 times for each direction	JIS C0041, A-7 Condition C
10	Vibration (with carton)	Random vibration: 0.015G <sup>2</sup> /Hz from 5~200Hz -6dB/octave from 200~500Hz	IEC 68-34
11	Drop (with carton)	Height: 60cm 1 corner, 3 edges, 6 surfaces	JIS Z0202

Note1: Ta: Ambient temperature.

Note2: Tp: Panel Surface Temperature

Note3: All the cosmetic specification is judged before the reliability stress.



# E. Packing form

Model no. : A101VW01 V3

Version : 1

Page : 17/22

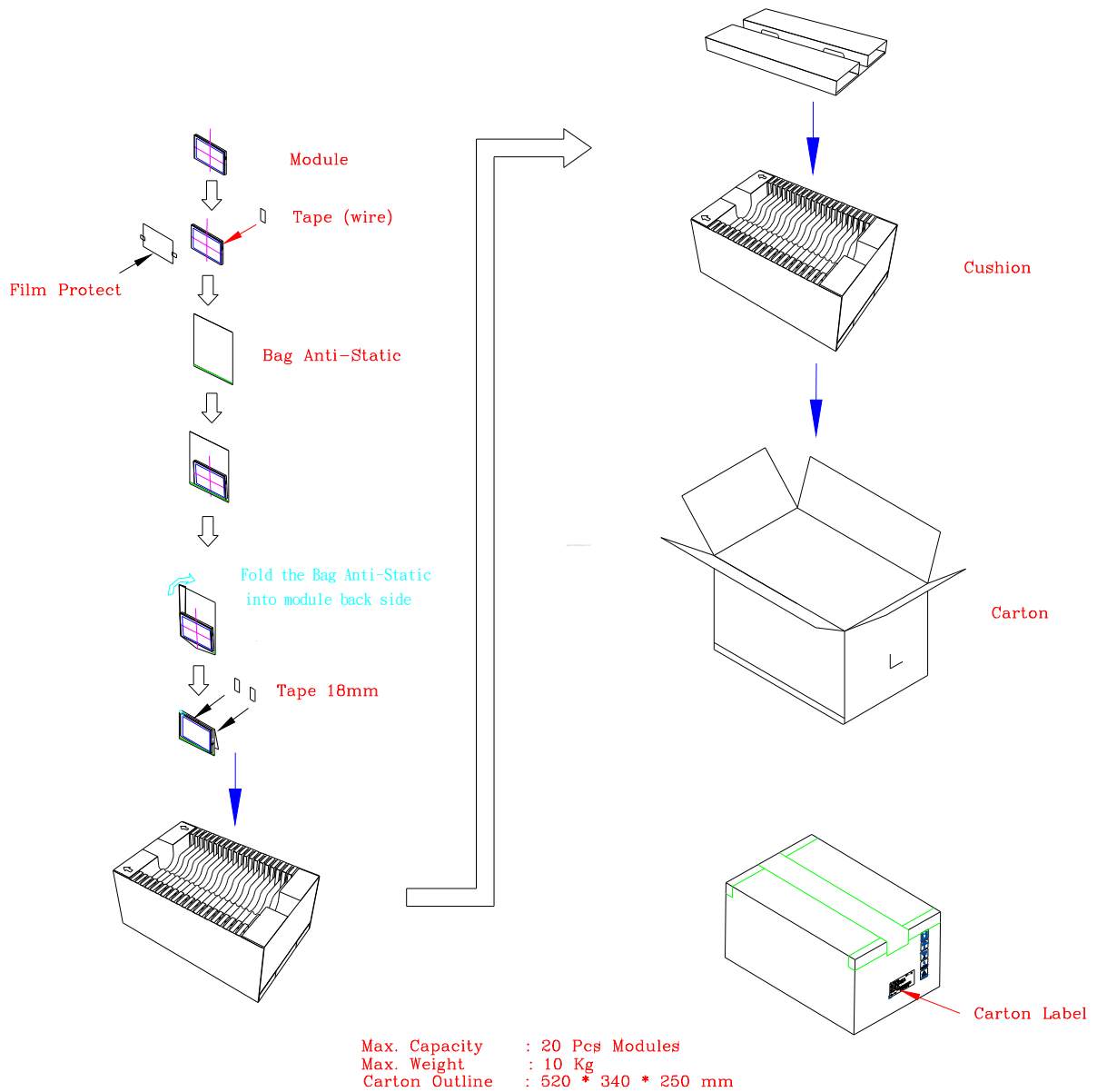

Appendix:

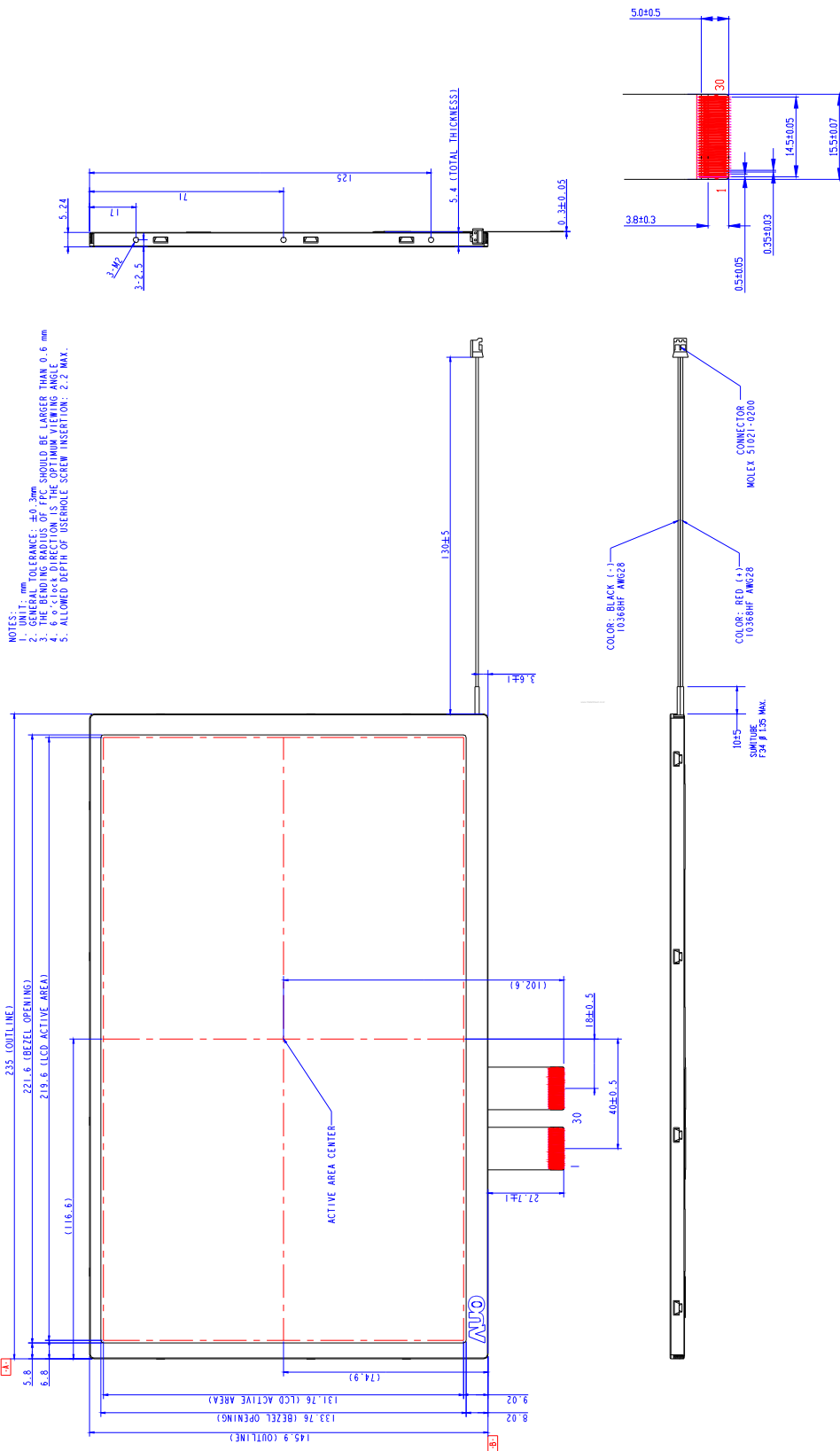

SCALE 2 / 1

Fig.1 Outline dimension of TFT-LCD module (Front Side)

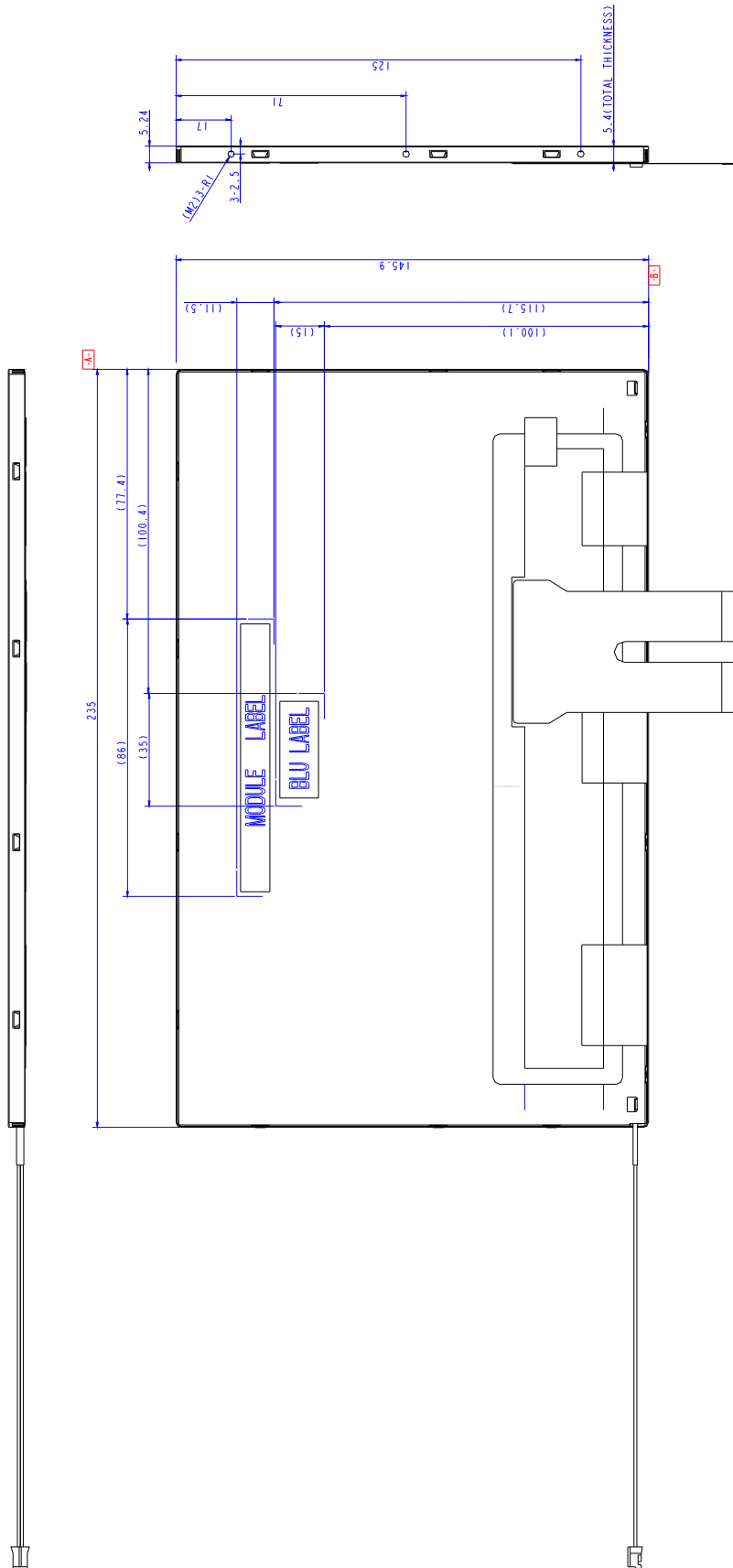

Fig.2 Outline dimension of TFT-LCD module (Rear Side)

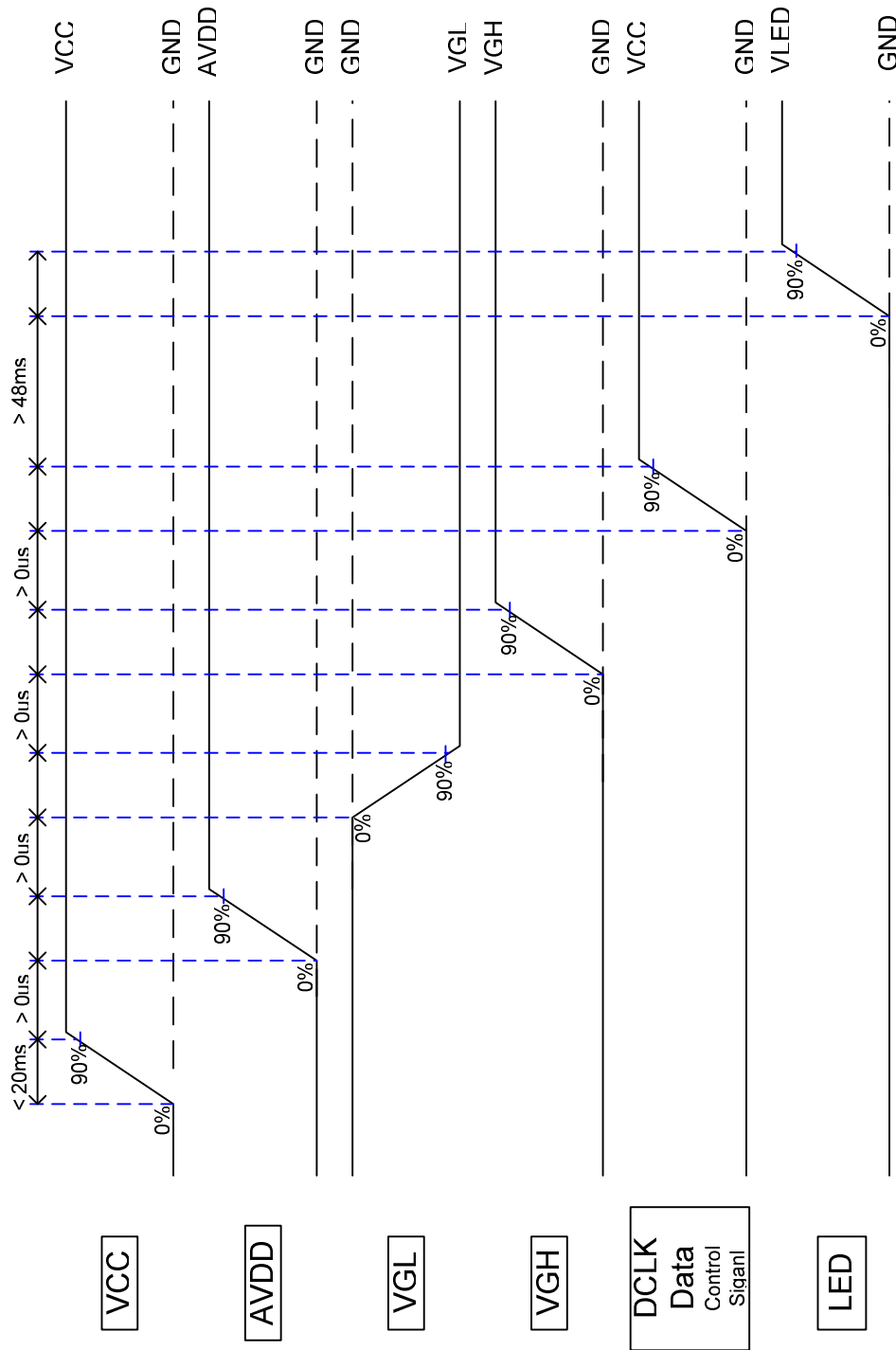

Fig.3 Power On sequence

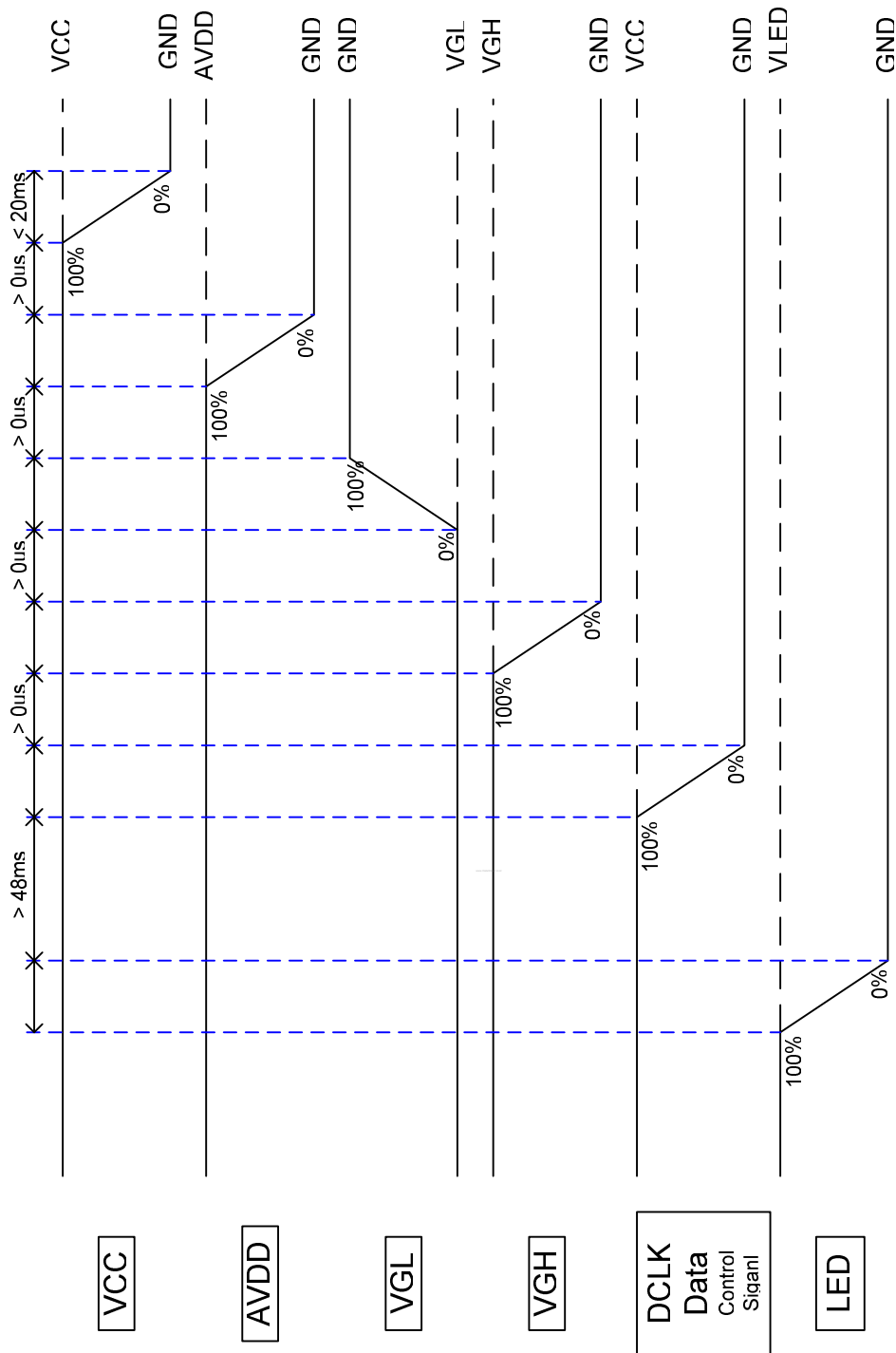
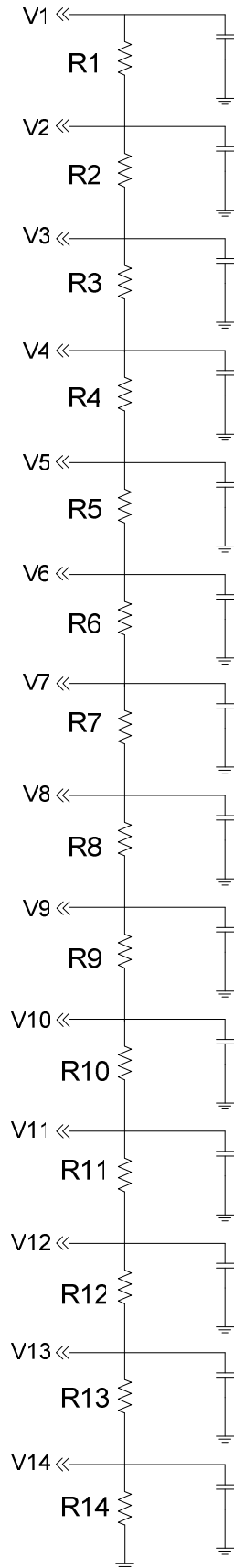

Fig.4 Power Off sequence



	Value(Ω)
R1	14.0
R2	127.0
R3	68.0
R4	52.3
R5	60.4
R6	91.0
R7	86.6
R8	215.0
R9	102.0
R10	56.2
R11	51.1
R12	133.0
R13	17.8
R14	19.6

	Value (V)
V1	8.60
V2	8.48
V3	7.32
V4	6.72
V5	6.27
V6	5.73
V7	5.15
V8	4.29
V9	3.35
V10	2.50
V11	2.03
V12	1.57
V13	0.36
V14	0.15

**Fig.5 Reference Gamma Voltage**