

Hall-Effect Latch for High Temperature Operation

FEATURES AND BENEFITS

- Symmetrical switchpoints
- Superior temperature stability
- Operation from unregulated supply
- Open-drain 25 mA output
- Reverse battery protection
- Activate with small, commercially available permanent magnets
- Solid-state reliability
- Small size
- Resistant to physical stress
- Enhanced ESD structures result in 8 kV HBM ESD performance without external protection components
- Internal protection circuits enable 40 V load dump compliance without external protection components

PACKAGES:

Not to scale

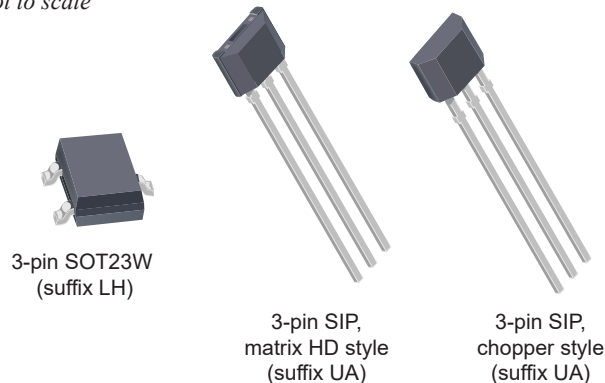

DESCRIPTION

These Hall-effect latches are extremely temperature-stable and stress resistant sensor ICs especially suited for operation over extended temperature ranges to 150°C. Superior high-temperature performance is made possible through a novel Schmitt trigger circuit that maintains operate and release point symmetry by compensating for temperature changes in the Hall element. Additionally, internal compensation provides magnetic switchpoints that become more sensitive with temperature, hence offsetting the usual degradation of the magnetic field with temperature. The symmetry capability makes these devices ideal for use in pulse-counting applications where duty cycle is an important parameter. The three basic devices (A1225, A1227, and A1229) are identical except for magnetic switchpoints.

Each device includes on a single silicon chip a voltage regulator, Hall-voltage generator, temperature compensation circuit, signal amplifier, Schmitt trigger, and a buffered open-drain output to sink up to 25 mA. The on-board regulator permits operation with supply voltages of 3.8 to 24 V.

The first character of the part number suffix determines the device operating temperature range. Suffix L is for -40°C to 150°C. Two package styles provide magnetically optimized packages for most applications. Suffix LH is a 3-pin SOT23W surface-mount package; suffix UA is a 3-pin ultramini SIP for through-hole mounting. The packages are lead (Pb) free with 100% matte-tin leadframe plating.

Functional Block Diagram

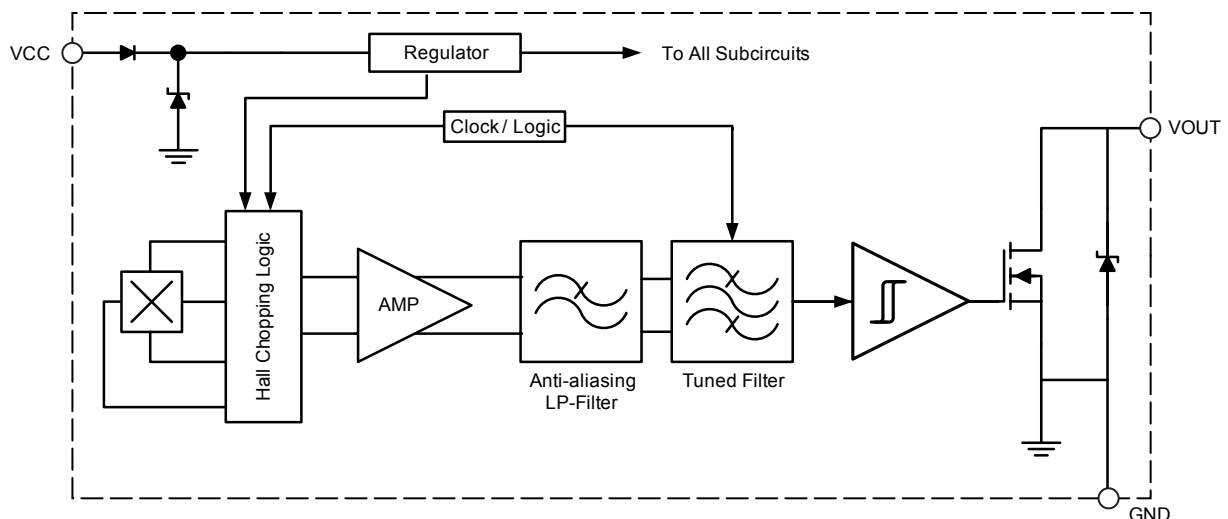

A1225, A1227 and A1229

Hall-Effect Latch for High Temperature Operation

SELECTION GUIDE

Part Number	Packing [1]	Package	Ambient Temperature, T_A	$B_{RP}(\min)$ (G)	$B_{OP}(\max)$ (G)
A1225LLHLT-T	7-in. reel, 3000 pieces/reel	3-pin SOT-23W surface mount	-40°C to 150°C	-300	300
A1225LLHLX-T	13-in. reel, 10000 pieces/reel	3-pin SOT-23W surface mount			
A1225LUA-T [2]	Bulk, 500 pieces/bag	3-pin SIP through hole			
A1227LLHLT-T	7-in. reel, 3000 pieces/reel	3-pin SOT-23W surface mount	-40°C to 150°C	-175	175
A1227LLHLX-T	13-in. reel, 10000 pieces/reel	3-pin SOT-23W surface mount			
A1227LUA-T	Bulk, 500 pieces/bag	3-pin SIP through hole			
A1229LLHLT-T	7-in. reel, 3000 pieces/reel	3-pin SOT-23W surface mount	-40°C to 150°C	-200	200
A1229LLHLX-T	13-in. reel, 10000 pieces/reel	3-pin SOT-23W surface mount			
A1229LUA-T	Bulk, 500 pieces/bag	3-pin SIP through hole			

[1] Contact Allegro™ for additional packaging options.

[2] The A1225LUA-T package option is in production, however, it has been deemed Pre-End of Life. The product is approaching end of life. Within a minimum of 6 months, the device will enter its final, Last Time Buy, order phase.



ABSOLUTE MAXIMUM RATINGS

Characteristic	Symbol	Notes	Rating	Unit
Forward Supply Voltage	V_{CC}		30	V
Reverse Supply Voltage	V_{RCC}		-30	V
Output Off Voltage	V_{OUT}		30	V
Reverse Output Voltage	V_{ROUT}		-0.5	V
Continuous Output Current	$I_{OUT(SINK)}$		25	mA
Operating Ambient Temperature	T_A	Range L	-40 to 150	°C
Maximum Junction Temperature	$T_J(\max)$		165	°C
Storage Temperature	T_{stg}		-65 to 170	°C

Pinout Diagrams

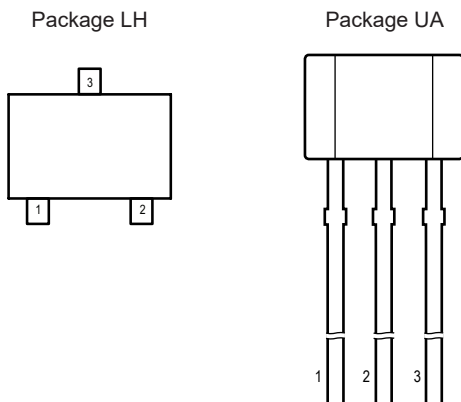

Terminal List Table

Number		Name	Function
LH	UA		
1	1	VCC	Input power supply
2	3	VOUT	Output signal
3	2	GND	Ground

A1225, A1227 and A1229

Hall-Effect Latch for High Temperature Operation

ELECTRICAL CHARACTERISTICS: Valid at $T_A = -40^\circ\text{C}$ to 150°C , $C_{\text{BYPASS}} = 0.1 \mu\text{F}$, $V_{\text{CC}} = 12 \text{V}$, unless otherwise noted

Characteristics	Symbol	Test Conditions	Min.	Typ. [1]	Max.	Unit [2]	
ELECTRICAL CHARACTERISTICS							
Supply Voltage	V_{CC}	Operating; $T_J \leq 165^\circ\text{C}$	3.8		24	V	
Supply Current	I_{CC}	$B < B_{\text{RP}}$ (Output off)	–	–	6	mA	
		$B > B_{\text{OP}}$ (Output on)	–	–	6	mA	
Supply Zener Voltage	$V_{\text{Z(sup)}}$	$I_{\text{CC}} = 9 \text{mA}$, $T_A = 25^\circ\text{C}$	28	–	–	V	
Reverse Battery Current	$I_{\text{Z(sup)}}$	$V_{\text{RCC}} = -28 \text{V}$, $T_A = 25^\circ\text{C}$	–	–	–5	mA	
Power-On Time [3]	t_{PO}		–	–	12	μs	
Power-On State	POS	$B < B_{\text{OP}}$	–	HIGH	–	–	
Chopping Frequency	f_{chop}		–	400	–	kHz	
OUTPUT STAGE CHARACTERISTICS							
Output Saturation Voltage	$V_{\text{OUT(sat)}}$	$I_{\text{OUT}} = 20 \text{mA}$	–	175	400	mV	
Output Leakage Current	I_{OFF}	$V_{\text{OUT}} = 24 \text{V}$, $B < B_{\text{RP}}$	–	< 1	10	μA	
Output Rise Time [3][4]	t_r	$R_L = 820 \Omega$, $C_L = 20 \text{pF}$	–	200	2000	ns	
Output Fall Time [3][4]	t_f	$R_L = 820 \Omega$, $C_L = 20 \text{pF}$	–	200	2000	ns	
Output Zener Voltage	$V_{\text{Z(out)}}$	$I_{\text{OUT}} = 3 \text{mA}$, $T_A = 25^\circ\text{C}$	30	–	–	V	
MAGNETIC CHARACTERISTICS							
Operate Point	B_{OP}	A1225	$T_A = 25^\circ\text{C}$	170	–	270	G
			Over operating temperature range	140	–	300	G
		A1227	$T_A = 25^\circ\text{C}$	50	–	150	G
			Over operating temperature range	50	–	175	G
		A1229	$T_A = 25^\circ\text{C}$	100	–	180	G
			Over operating temperature range	80	–	200	G
Release Point	B_{RP}	A1225	$T_A = 25^\circ\text{C}$	–270	–	–170	G
			Over operating temperature range	–300	–	–140	G
		A1227	$T_A = 25^\circ\text{C}$	–150	–	–50	G
			Over operating temperature range	–175	–	–50	G
		A1229	$T_A = 25^\circ\text{C}$	–180	–	–100	G
			Over operating temperature range	–200	–	–80	G
Hysteresis ($B_{\text{OP}} - B_{\text{RP}}$)	B_{HYS}	A1225	$T_A = 25^\circ\text{C}$	340	–	540	G
			Over operating temperature range	280	–	600	G
		A1227	$T_A = 25^\circ\text{C}$	100	–	300	G
			Over operating temperature range	100	–	350	G
		A1229	$T_A = 25^\circ\text{C}$	200	–	360	G
			Over operating temperature range	160	–	400	G

[1] Typical data are at $T_A = 25^\circ\text{C}$ and $V_{\text{CC}} = 12 \text{V}$, and are for design estimations only.

[2] 1 G (gauss) = 0.1 mT (millitesla).

[3] Minimum and maximum specifications verified by bench characterization and not guaranteed by Allegro final test.

[4] C_L = oscilloscope probe capacitance.

THERMAL CHARACTERISTICS: May require derating at maximum conditions; see application information

Characteristic	Symbol	Notes	Rating	Unit
Package Thermal Resistance	$R_{\theta JA}$	Package LH, 2-layer PCB with 0.463 in. ² of copper area each side connected by thermal vias	110	°C/W
		Package LH, 1-layer PCB with copper limited to solder pads	228	°C/W
		Package UA, 1-layer PCB with copper limited to solder pads	165	°C/W

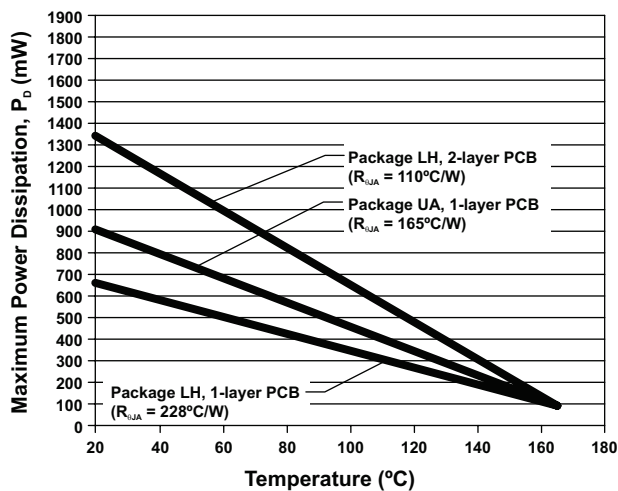
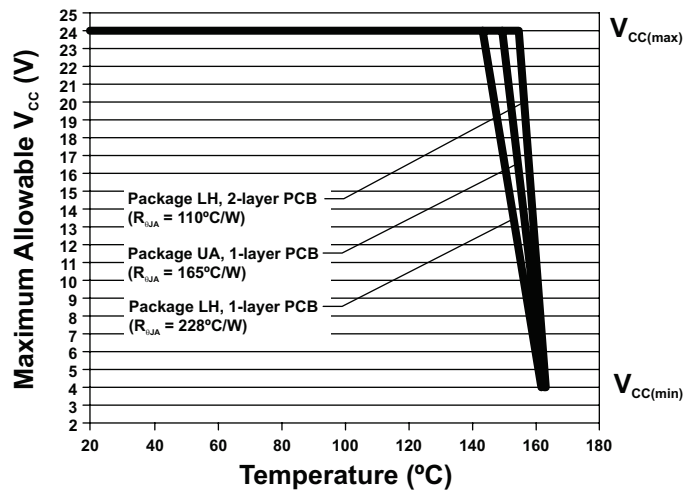

CHARACTERISTIC PERFORMANCE

A1225, A1227, and A1229 Electrical Characteristics

Average Supply Current (On) versus Ambient Temperature

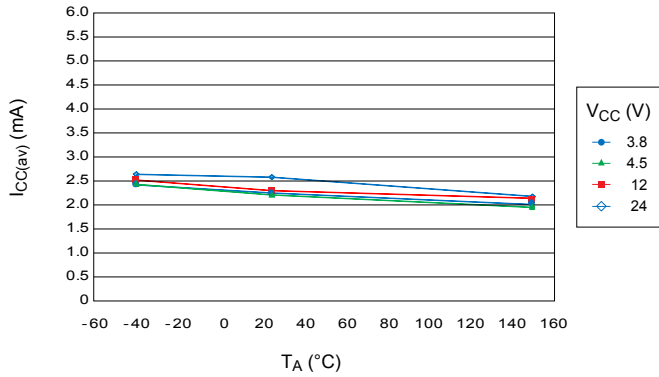

Average Supply Current (On) versus Supply Voltage

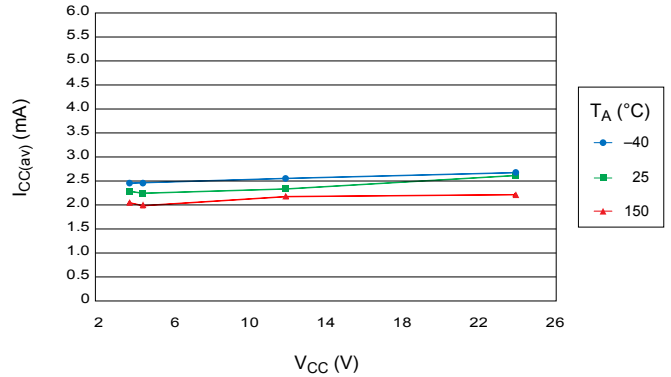

Average Supply Current (Off) versus Ambient Temperature

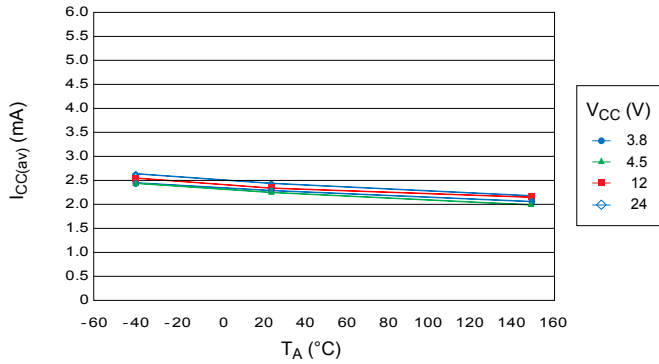

Average Supply Current (Off) versus Supply Voltage

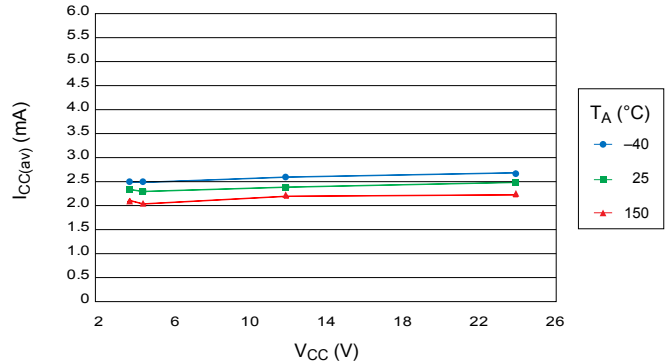

Average Output Saturation Voltage versus Ambient Temperature

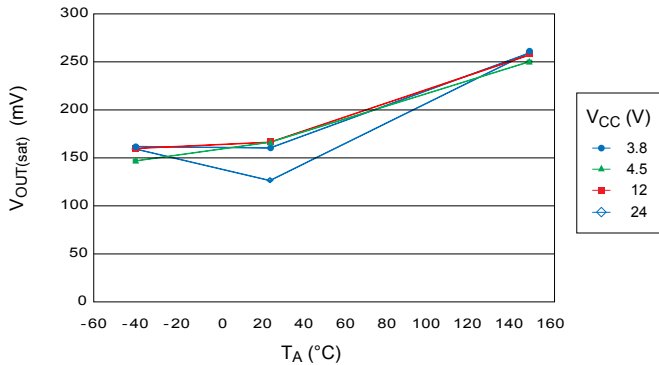

Average Output Saturation Voltage versus Supply Voltage

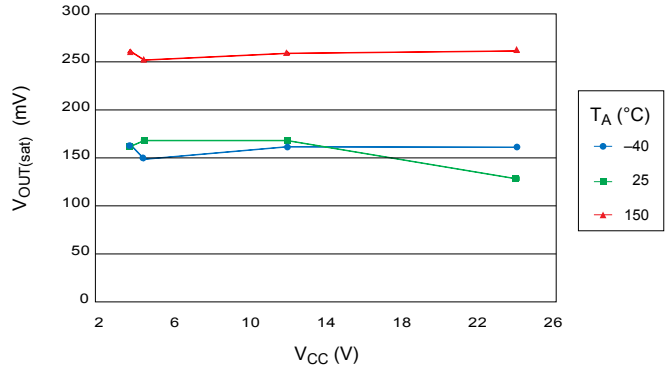

A1225 Magnetic Characteristics

Operate Point versus Ambient Temperature

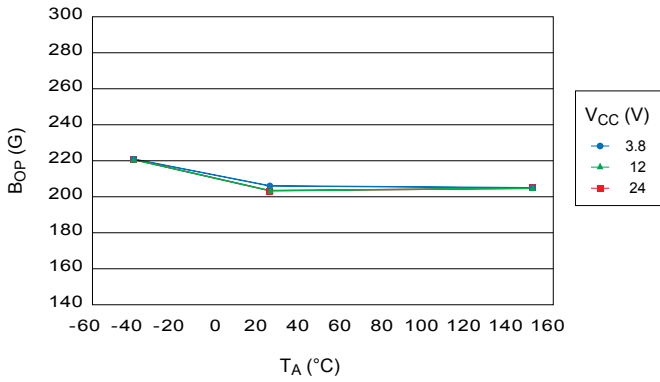

Operate Point versus Supply Voltage

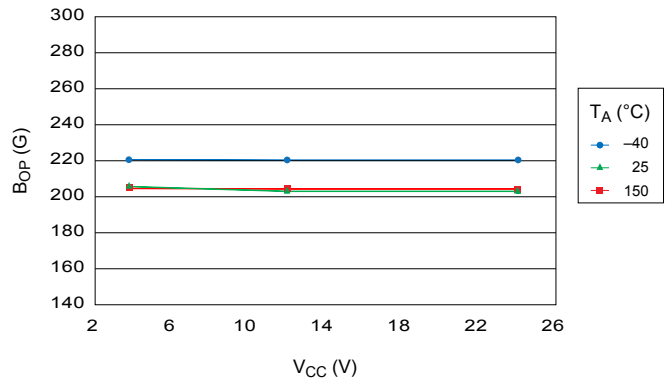

Release Point versus Ambient Temperature

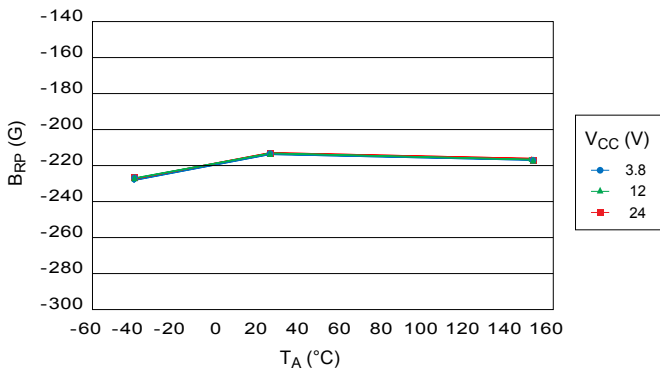

Release Point versus Supply Voltage

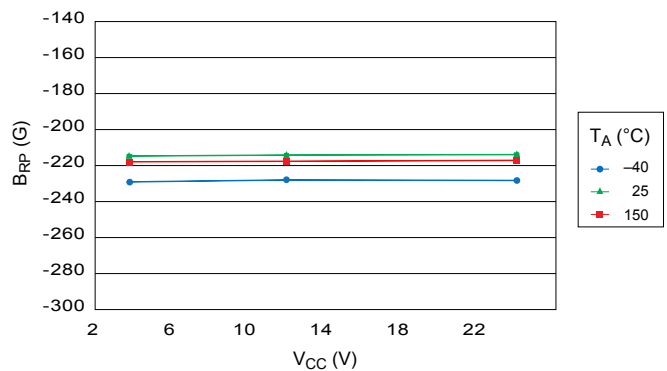

Switchpoint Hysteresis versus Ambient Temperature

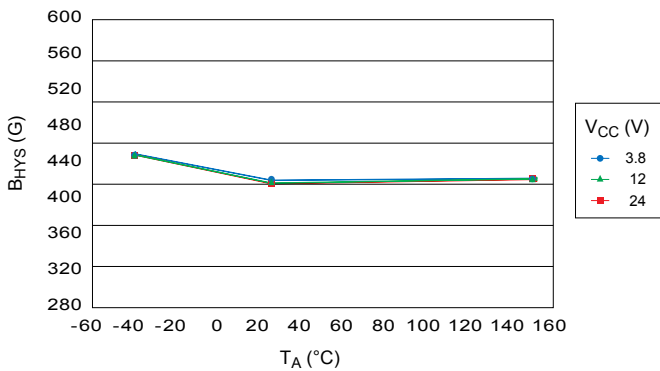

Switchpoint Hysteresis versus Supply Voltage

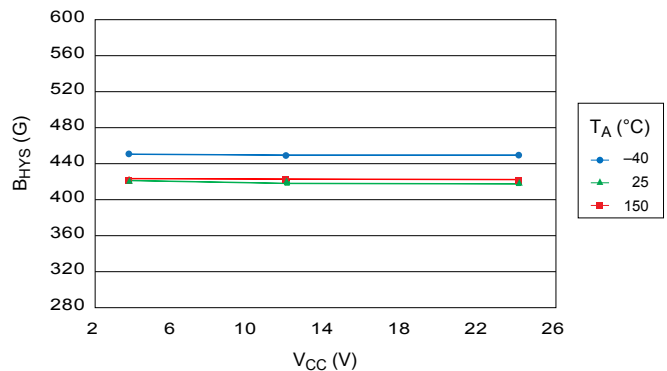

A1227 Magnetic Characteristics

Operate Point versus Ambient Temperature

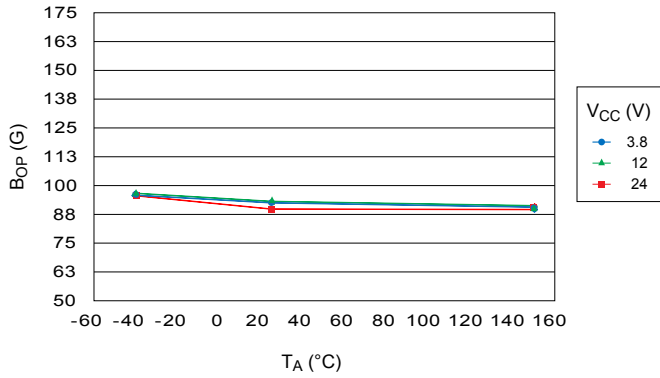

Operate Point versus Supply Voltage

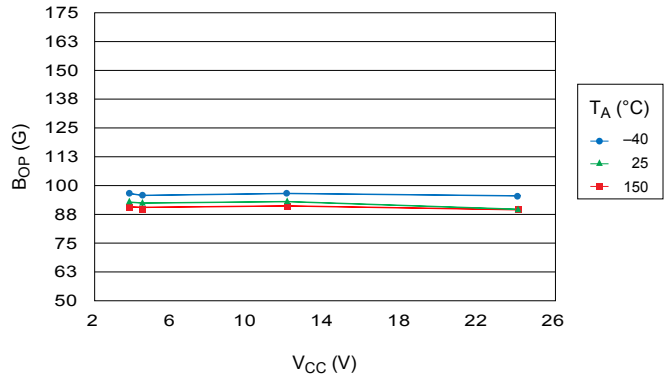

Release Point versus Ambient Temperature

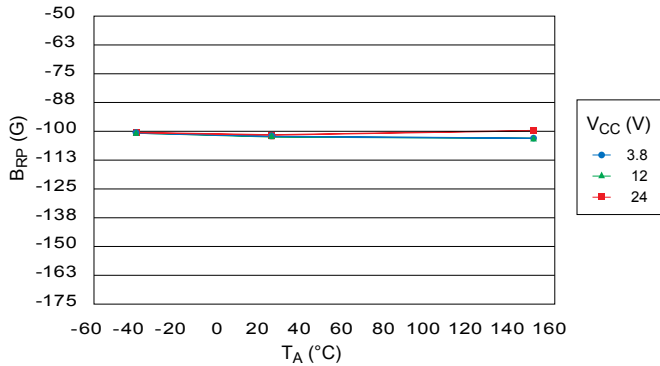

Release Point versus Supply Voltage

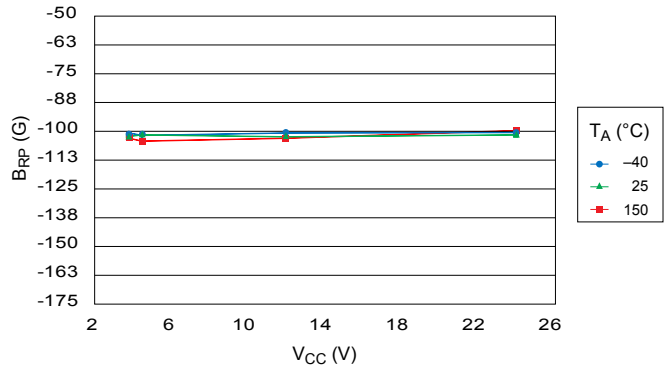

Switchpoint Hysteresis versus Ambient Temperature

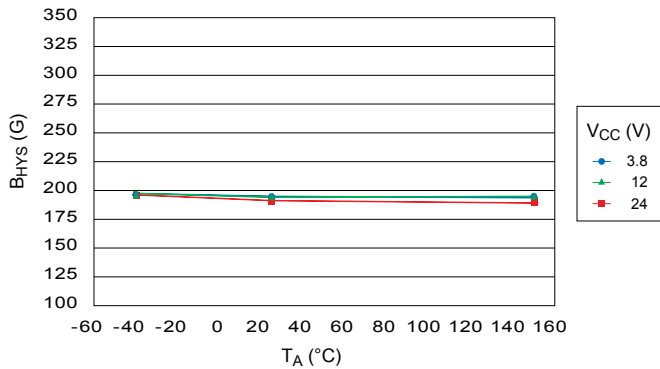

Switchpoint Hysteresis versus Supply Voltage

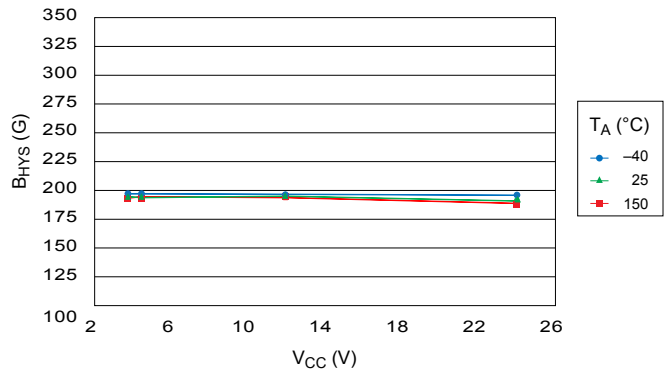

A1229 Magnetic Characteristics

Operate Point versus Ambient Temperature

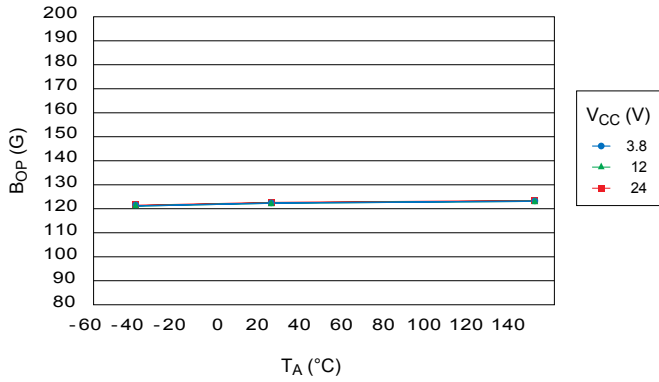

Operate Point versus Supply Voltage

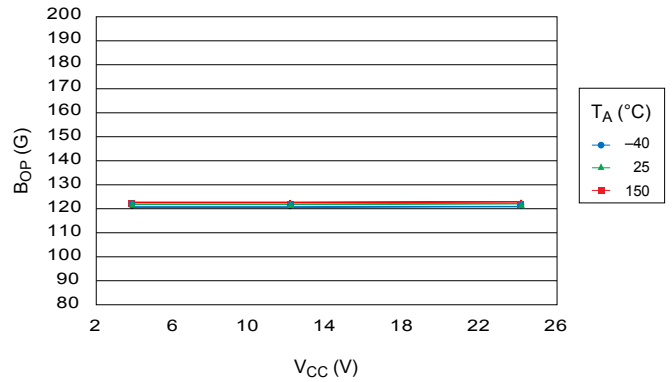

Release Point versus Ambient Temperature

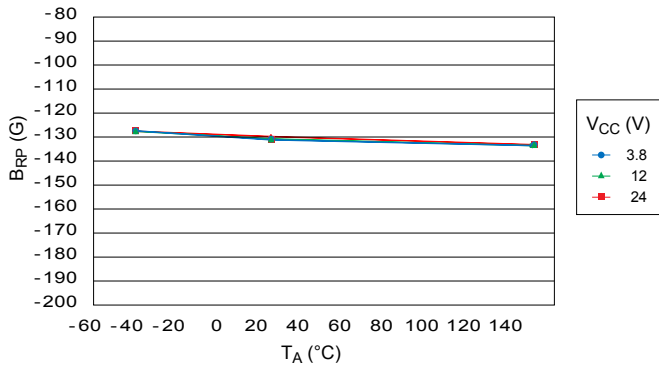

Release Point versus Supply Voltage

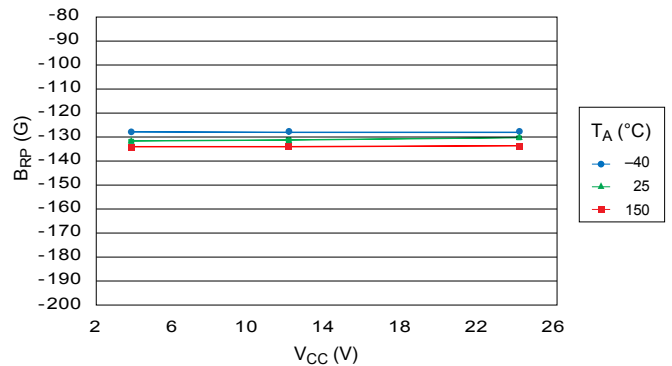

Switchpoint Hysteresis versus Ambient Temperature

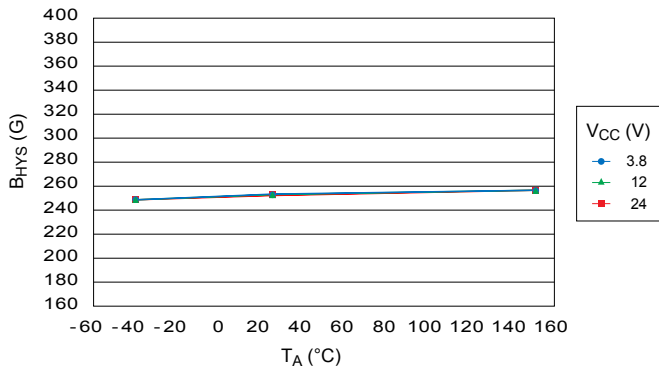

Switchpoint Hysteresis versus Supply Voltage

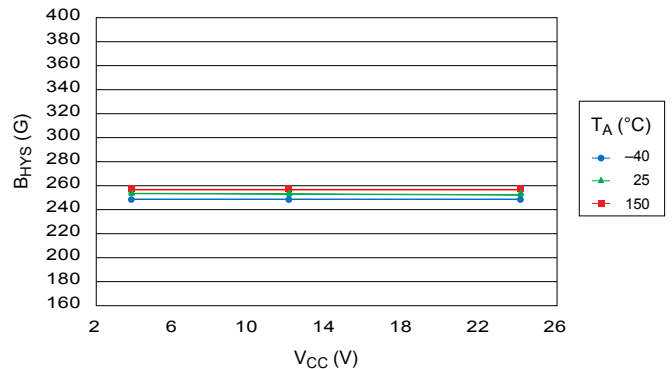

FUNCTIONAL DESCRIPTION AND APPLICATION INFORMATION

SWITCHING BEHAVIOR

The output of the A1225, A1227, and A1229 devices switches low (turns on) when a magnetic field perpendicular to the Hall element exceeds the operate point threshold, B_{OP} (see figure 1). After turn-on, the output is capable of sinking 25 mA and the output voltage is $V_{OUT(sat)}$. Notice that the device latches; that is, a south pole of sufficient strength towards the branded surface of the device turns the device on, and the device remains on with removal of the south pole.

When the magnetic field is reduced below the release point, B_{RP} , the device output goes high (turns off). The difference between the magnetic operate point and release point is the hysteresis, B_{HYS} , of the device. This built-in hysteresis allows clean switching of the output, even in the presence of external mechanical vibration and electrical noise.

When the device is powered-on in the hysteresis range, less than B_{OP} and higher than B_{RP} , the device output goes high. The correct output state is attained after the first excursion beyond B_{OP} or B_{RP} .

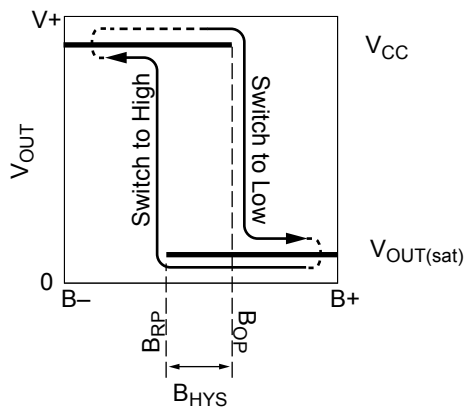

Figure 1. Output switching characteristics

APPLICATION INFORMATION

The simplest form of magnet that will operate these devices is a ring magnet, as shown in figure 2. Other methods of operation are possible.

In three-wire applications the device output is connected through a pull-up resistor to the supply pin or separate battery voltage (figure 3). Switching of the output signal indicates sufficient change of the magnetic field.

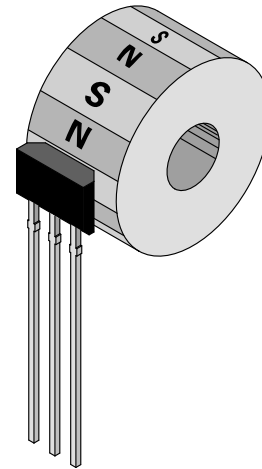

Figure 2. Typical magnetic target configuration using a ring magnet

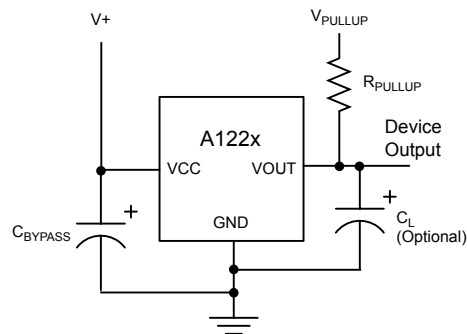

Figure 3. Typical 3-wire application circuit

CHOPPER STABILIZATION TECHNIQUE

When using Hall-effect technology, a limiting factor for switchpoint accuracy is the small signal voltage developed across the Hall element. This voltage is disproportionately small relative to the offset that can be produced at the output of the Hall sensor IC. This makes it difficult to process the signal while maintaining an accurate, reliable output over the specified operating temperature and voltage ranges. Chopper stabilization is a unique approach used to minimize Hall offset on the chip. Allegro employs a technique to remove key sources of the output drift induced by thermal and mechanical stresses. This offset reduction technique is based on a signal modulation-demodulation process. The undesired offset signal is separated from the magnetic field-induced signal in the frequency domain, through modulation. The subsequent demodulation acts as a modulation process for the offset, causing the magnetic field-induced signal to recover its original spectrum at base band, while the DC offset becomes

a high-frequency signal. The magnetic-sourced signal then can pass through a low-pass filter, while the modulated DC offset is suppressed. In addition to the removal of the thermal and stress related offset, this novel technique also reduces the amount of thermal noise in the Hall sensor IC while completely removing the modulated residue resulting from the chopper operation. The chopper stabilization technique uses a high-frequency sampling clock. For the demodulation process, a sample-and-hold technique is used. This high-frequency operation allows a greater sampling rate, which results in higher accuracy and faster signal-processing capability. This approach desensitizes the chip to the effects of thermal and mechanical stresses, and produces devices that have extremely stable quiescent Hall output voltages and precise recoverability after temperature cycling. This technique is made possible through the use of a BiCMOS process, which allows the use of low-offset, low-noise amplifiers in combination with high-density logic integration and sample-and-hold circuits.

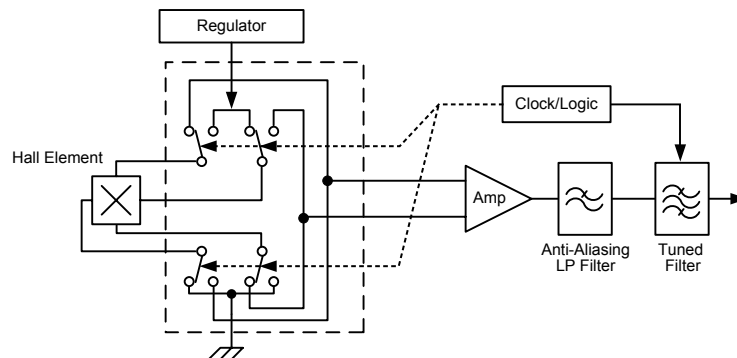
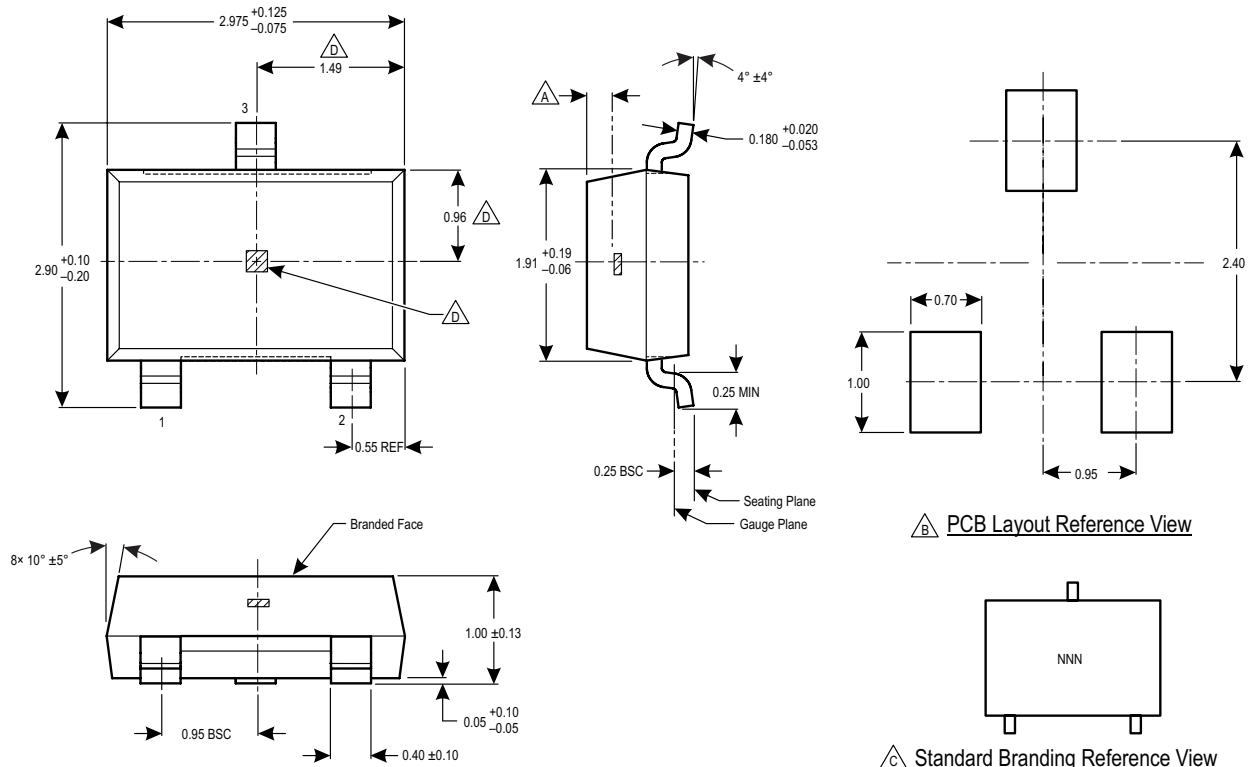

Figure 4. Chopper stabilization technique

Package LH 3-Pin SOT23W

For Reference Only – Not for Tooling Use

(Reference DWG-0000628)
 Dimensions in millimeters – NOT TO SCALE
 Dimensions exclusive of mold flash, gate burrs, and dambar protrusions
 Exact case and lead configuration at supplier discretion within limits shown



△ B PCB Layout Reference View

△ C Standard Branding Reference View

N = Last three digits of device part number

- △ A** Active Area Depth, 0.28 ± 0.04 mm
- △ B** Reference land pattern layout; all pads a minimum of 0.20 mm from all adjacent pads; adjust as necessary to meet application process requirements and PCB layout tolerances
- △ C** Branding scale and appearance at supplier discretion
- △ D** Hall elements, not to scale

A1225, A1227 and A1229

Hall-Effect Latch for High Temperature Operation

Package UA 3-Pin SIP, Chopper Style

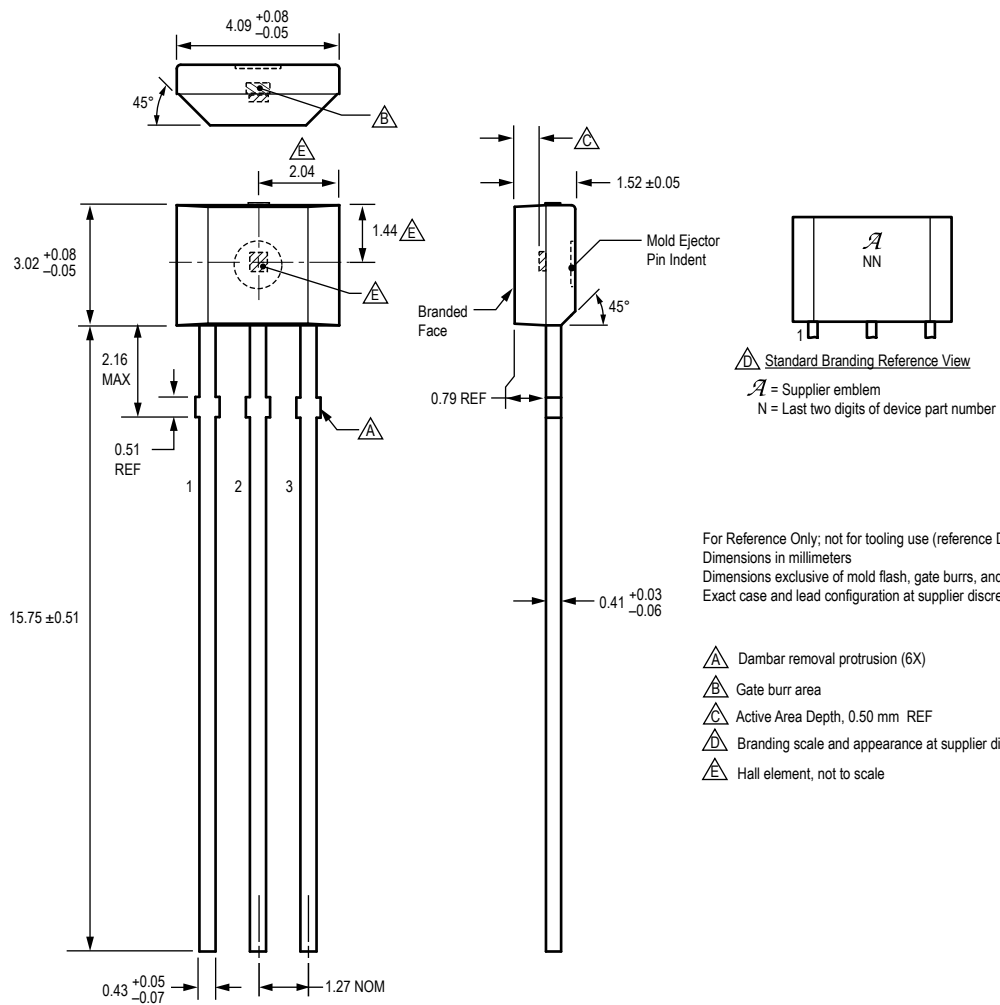

Revision History

Revision	Revision Date	Description of Revision
2	May 8, 2013	Update product offerings, editorial correction to $I_{Z(sup)}$
3	March 7, 2016	Updated product offerings
4	October 31, 2016	Chopper-style UA package designated as not for new design
5	June 19, 2018	Corrected matrix-style UA package drawing
6	September 10, 2018	Updated product status to not for new design
7	September 30, 2019	Updated LH package drawing (p. 11), and other minor editorial updates
8	September 29, 2023	Updated A1225LUA-T part variant product status to pre-end-of-life

Copyright 2023, Allegro MicroSystems.

Allegro MicroSystems reserves the right to make, from time to time, such departures from the detail specifications as may be required to permit improvements in the performance, reliability, or manufacturability of its products. Before placing an order, the user is cautioned to verify that the information being relied upon is current.

Allegro's products are not to be used in any devices or systems, including but not limited to life support devices or systems, in which a failure of Allegro's product can reasonably be expected to cause bodily harm.

The information included herein is believed to be accurate and reliable. However, Allegro MicroSystems assumes no responsibility for its use; nor for any infringement of patents or other rights of third parties which may result from its use.

Copies of this document are considered uncontrolled documents.

For the latest version of this document, visit our website:

www.allegromicro.com