

Silicon PNP Power Transistors

2SA1262

DESCRIPTION

- With TO-220 package
- Complement to type 2SC3179

APPLICATIONS

- Audio and general purpose

PINNING

PIN	DESCRIPTION
1	Emitter
2	Collector;connected to mounting base
3	Base

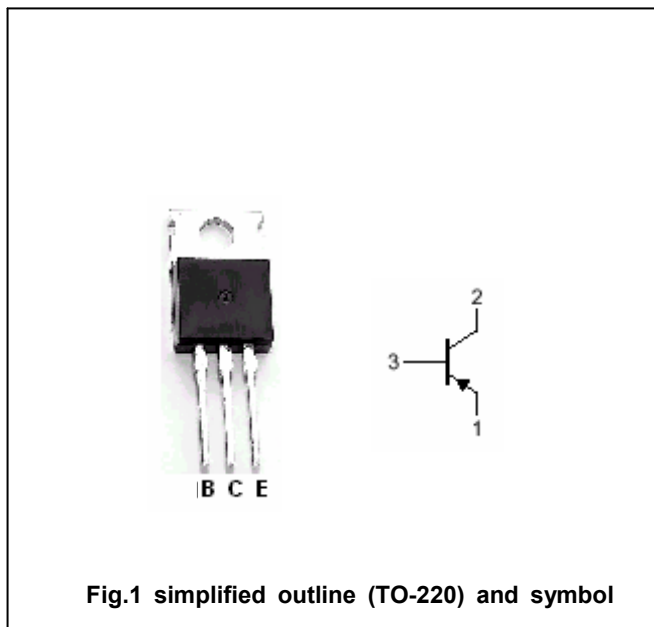

Absolute maximum ratings(Ta=25°C)

SYMBOL	PARAMETER	CONDITIONS	VALUE	UNIT
V _{CB0}	Collector-base voltage	Open emitter	-60	V
V _{CEO}	Collector-emitter voltage	Open base	-60	V
V _{EBO}	Emitter-base voltage	Open collector	-6	V
I _C	Collector current		-4	A
I _B	Base current		-1	A
P _C	Collector power dissipation	T _C =25°C	30	W
T _j	Junction temperature		150	°C
T _{stg}	Storage temperature		-55~150	°C

Silicon PNP Power Transistors

2SA1262

CHARACTERISTICS

T_j=25 °C unless otherwise specified

SYMBOL	PARAMETER	CONDITIONS	MIN	TYP.	MAX	UNIT
V _{(BR)CEO}	Collector-emitter breakdown voltage	I _C =-25mA, I _B =0	-60			V
V _{CEsat}	Collector-emitter saturation voltage	I _C =-2A; I _B =-0.2A			-0.6	V
I _{CBO}	Collector cut-off current	V _{CB} =-60V; I _E =0			-100	μA
I _{EBO}	Emitter cut-off current	V _{EB} =-6V; I _C =0			-100	μA
h _{FE}	DC current gain	I _C =-1A; V _{CE} =-4V	40			
f _T	Transition frequency	I _E =0.2A; V _{CE} =-12V		15		MHz
C _{ob}	Output capacitance	I _E =0; V _{CB} =-10V; f=1MHz		90		pF

Switching times

t _{on}	Turn-on time	I _C =-2A; I _{B1} =- I _{B2} =-0.2A R _L =10Ω; V _{CC} =-20V		0.25		μs
t _s	Storage time			0.75		μs
t _f	Fall time			0.25		μs

Silicon PNP Power Transistors

2SA1262

PACKAGE OUTLINE

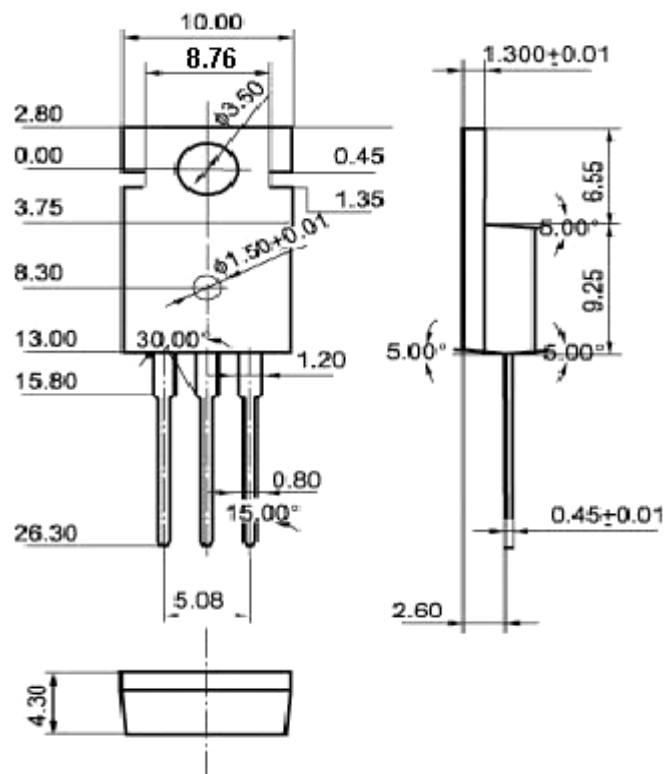

Fig.2 Outline dimensions(unindicated tolerance:±0.10 mm)

Silicon PNP Power Transistors

2SA1262

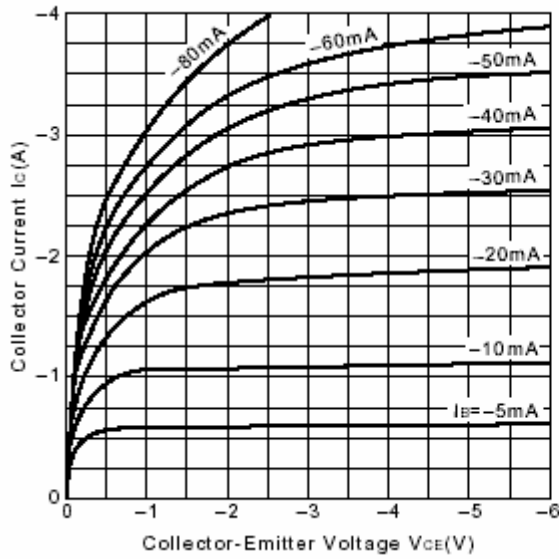

Fig.3 Static Characteristic

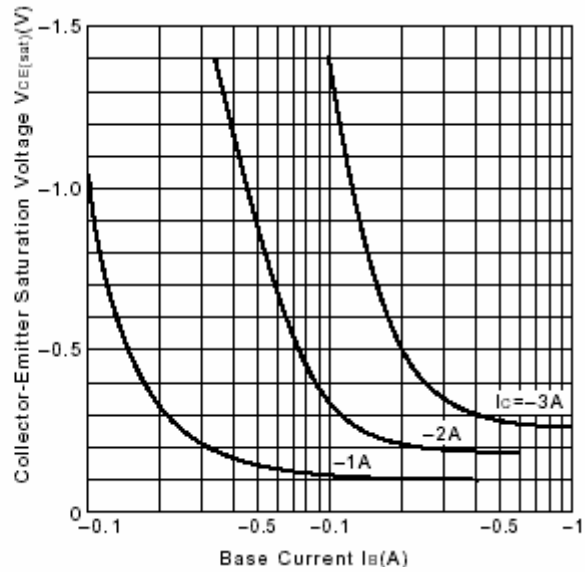

Fig.4 $V_{CE(sat)}-I_B$ Characteristics

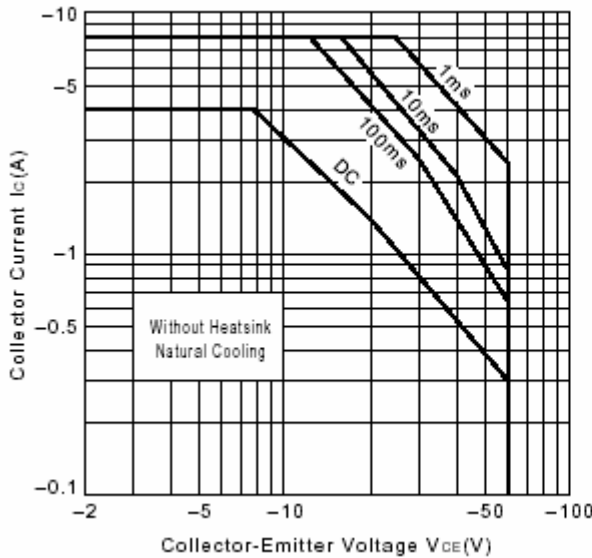

Fig.5 Safe Operating Area

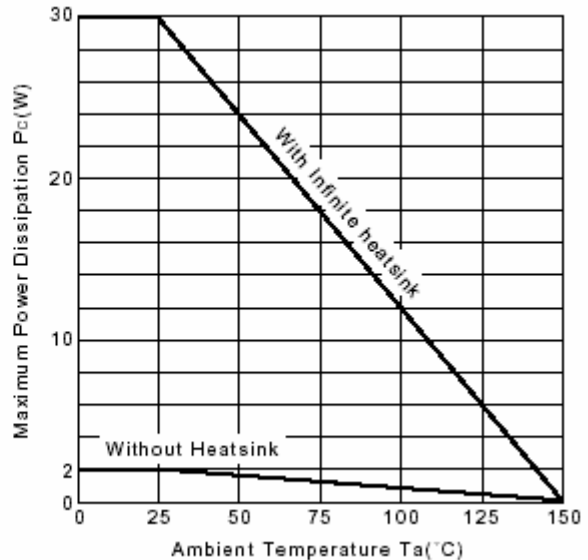

Fig.6 P_c-T_a Derating

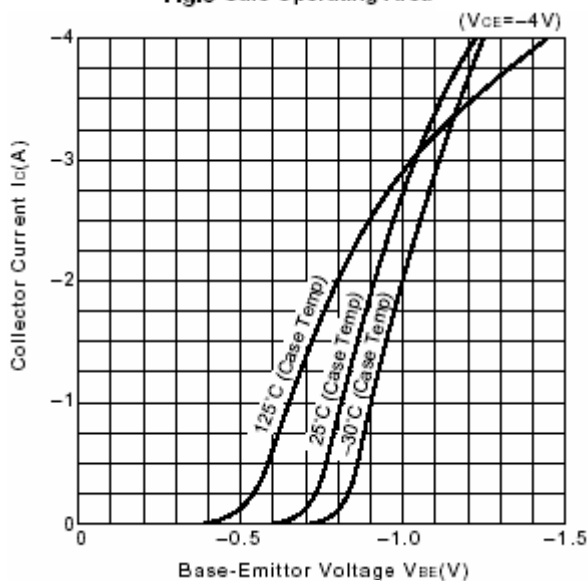

Fig.7 I_C-V_{BE}

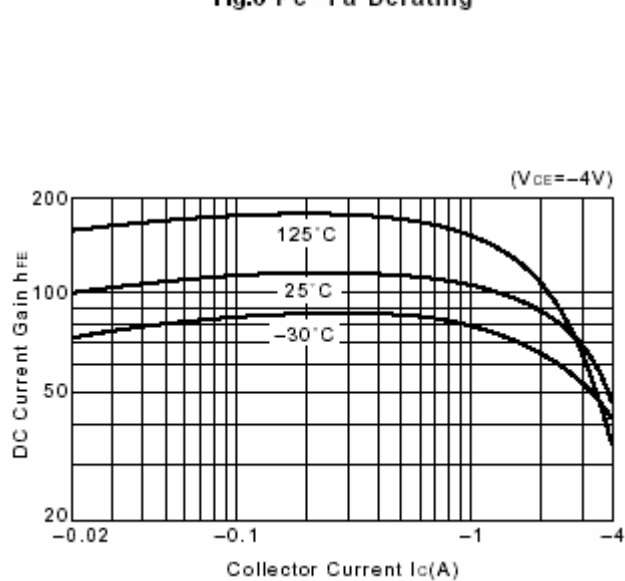

Fig.8 DC current Gain