

Silicon PNP Power Transistors

2SA1329

DESCRIPTION

- With TO-220 package
- Complement to type 2SC3346
- Low collector saturation voltage
- High speed switching time

APPLICATIONS

- High current switching applications

PINNING

PIN	DESCRIPTION
1	Emitter
2	Collector;connected to mounting base
3	Base

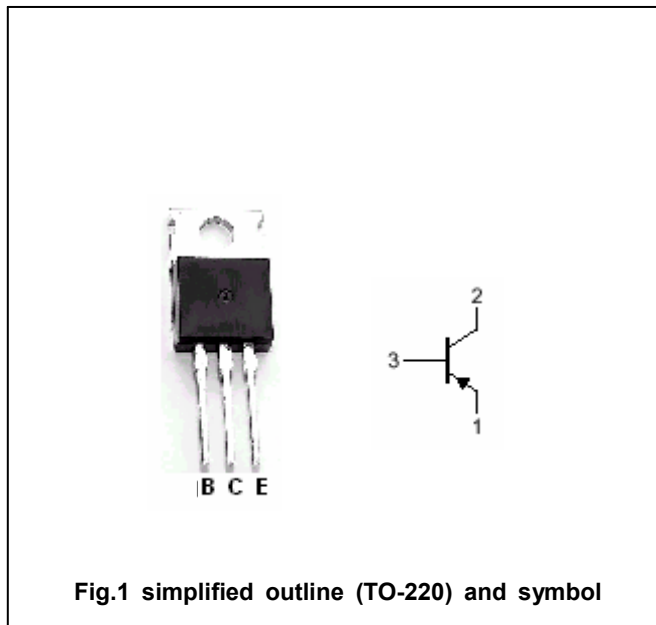

Fig.1 simplified outline (TO-220) and symbol

Absolute maximum ratings(Ta=25°C)

SYMBOL	PARAMETER	CONDITIONS	VALUE	UNIT
V _{CBO}	Collector-base voltage	Open emitter	-80	V
V _{CEO}	Collector-emitter voltage	Open base	-80	V
V _{EBO}	Emitter-base voltage	Open collector	-6	V
I _C	Collector current		-12	A
I _B	Base current		-2	A
P _C	Collector power dissipation	T _C =25°C	40	W
T _j	Junction temperature		150	°C
T _{stg}	Storage temperature		-55~150	°C

Silicon PNP Power Transistors

2SA1329

CHARACTERISTICS

T_j=25°C unless otherwise specified

SYMBOL	PARAMETER	CONDITIONS	MIN	TYP.	MAX	UNIT
V _{(BR)CEO}	Collector-emitter breakdown voltage	I _C =-50mA, I _B =0	-80			V
V _{CEsat}	Collector-emitter saturation voltage	I _C =-6A; I _B =-0.3A		-0.2	-0.4	V
V _{BEsat}	Base-emitter saturation voltage	I _C =-6A; I _B =-0.3A		-0.9	-1.2	V
I _{CBO}	Collector cut-off current	V _{CB} =-80V; I _E =0			-10	μA
I _{EBO}	Emitter cut-off current	V _{EB} =-6V; I _C =0			-10	μA
h _{FE-1}	DC current gain	I _C =-1A; V _{CE} =-1V	70		240	
h _{FE-2}	DC current gain	I _C =-6A; V _{CE} =-1V	40			
C _{ob}	Output capacitance	I _E =0; V _{CB} =-10V; f=1MHz		400		pF
f _T	Transition frequency	I _C =-1A; V _{CE} =-5V		50		MHz

Switching times

t _{on}	Turn-on time	I _{B1} =- I _{B2} =-0.3A R _L =5Ω; V _{CC} =-30V		0.3		μs
t _s	Storage time			1.0		μs
t _f	Fall time			0.5		μs

◆ h_{FE-1} Classifications

O	Y
70-140	120-240

Silicon PNP Power Transistors

2SA1329

PACKAGE OUTLINE

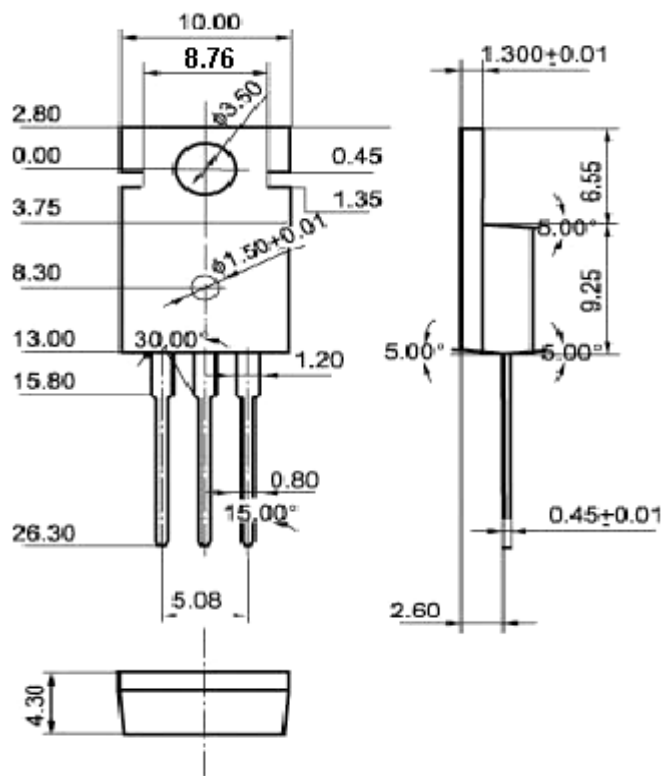

Fig.2 Outline dimensions(unindicated tolerance: ± 0.10 mm)

Silicon PNP Power Transistors

2SA1329

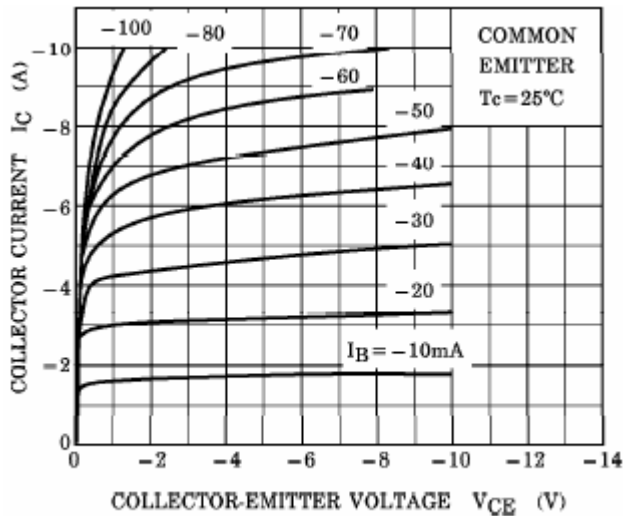

Fig.3 Static Characteristic

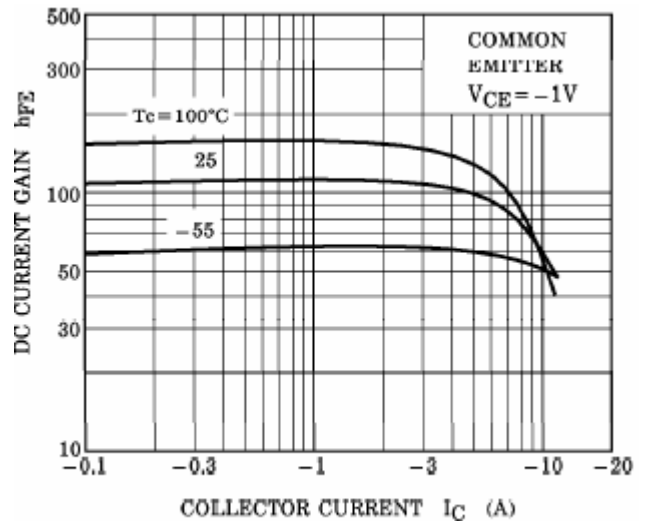

Fig.4 DC current Gain

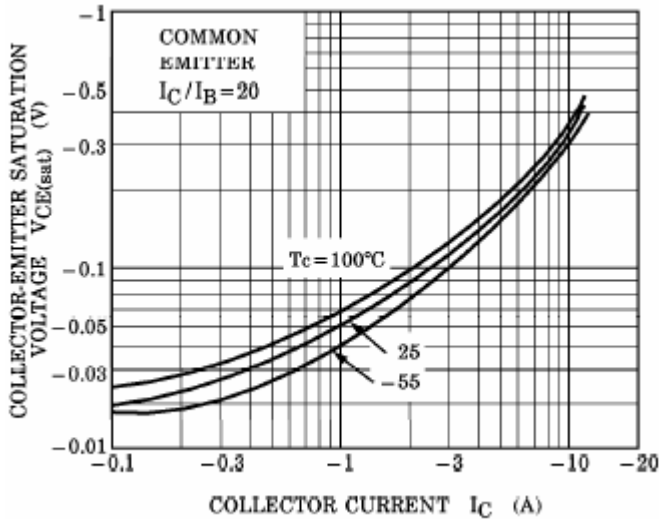

Fig.5 Collector-Emitter Saturation Voltage

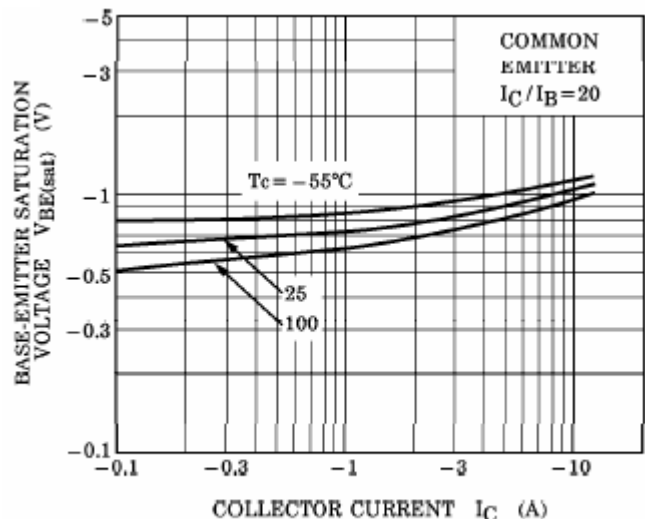

Fig.6 Base-Emitter Saturation Voltage

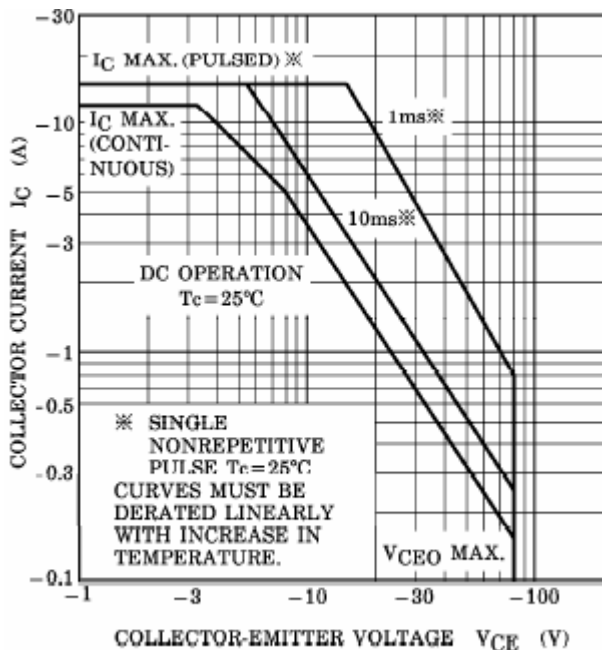

Fig.7 Safe Operating Area