

Silicon PNP Power Transistors

2SA1598

DESCRIPTION

- With ITO-220 package
- Switching power transistor
- Low collector saturation voltage

PINNING

PIN	DESCRIPTION
1	Base
2	Collector
3	Emitter

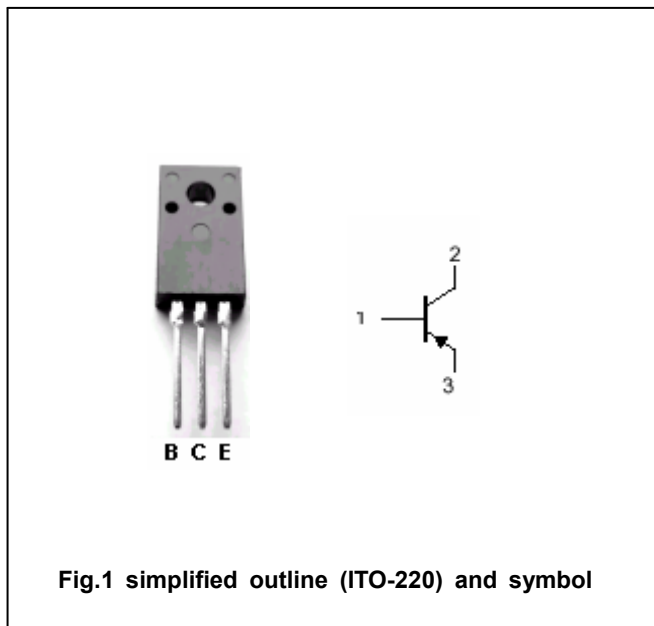

Absolute maximum ratings(Ta=25°C)

SYMBOL	PARAMETER	CONDITIONS	VALUE	UNIT
V _{CBO}	Collector-base voltage	Open emitter	-60	V
V _{CEO}	Collector-emitter voltage	Open base	-40	V
V _{EBO}	Emitter-base voltage	Open collector	-7	V
I _C	Collector current		-7	A
I _{CM}	Collector current-Peak		-14	A
I _B	Base current		-1.5	A
I _{BM}	Base current-Peak		-2	A
P _T	Total power dissipation	T _C =25°C	25	W
T _j	Junction temperature		150	°C
T _{stg}	Storage temperature		-55~150	°C

THERMAL CHARACTERISTICS

SYMBOL	PARAMETER	MAX	UNIT
R _{th j-c}	Thermal resistance junction case	5.0	°C/W

Silicon PNP Power Transistors

2SA1598

CHARACTERISTICS

T_j=25°C unless otherwise specified

SYMBOL	PARAMETER	CONDITIONS	MIN	TYP.	MAX	UNIT
V _{CEO(SUS)}	Collector-emitter sustaining voltage	I _C =-0.1A ; I _B =0	-40			V
V _{CEsat}	Collector-emitter saturation voltage	I _C =-3.5A; I _B =-0.2A			-0.3	V
V _{BEsat}	Base-emitter saturation voltage	I _C =-3.5A; I _B =-0.2A			-1.2	V
I _{CBO}	Collector cut-off current	At rated volatge			-0.1	mA
I _{CEO}						
I _{EBO}	Emitter cut-off current	At rated volatge			-0.1	mA
h _{FE}	DC current gain	I _C =-3.5A ; V _{CE} =-2V	70			
f _T	Transition frequency	I _C =-0.7A ; V _{CE} =-10V		50		MHz

Switching times

t _{on}	Turn-on time	I _C =-3.5A; I _{B1} =-I _{B2} =-0.35A , R _L =8Ω; V _{BB2} =-4V			0.3	μs
t _s	Storage time				1.5	μs
t _f	Fall time				0.5	μs

Silicon PNP Power Transistors

2SA1598

PACKAGE OUTLINE

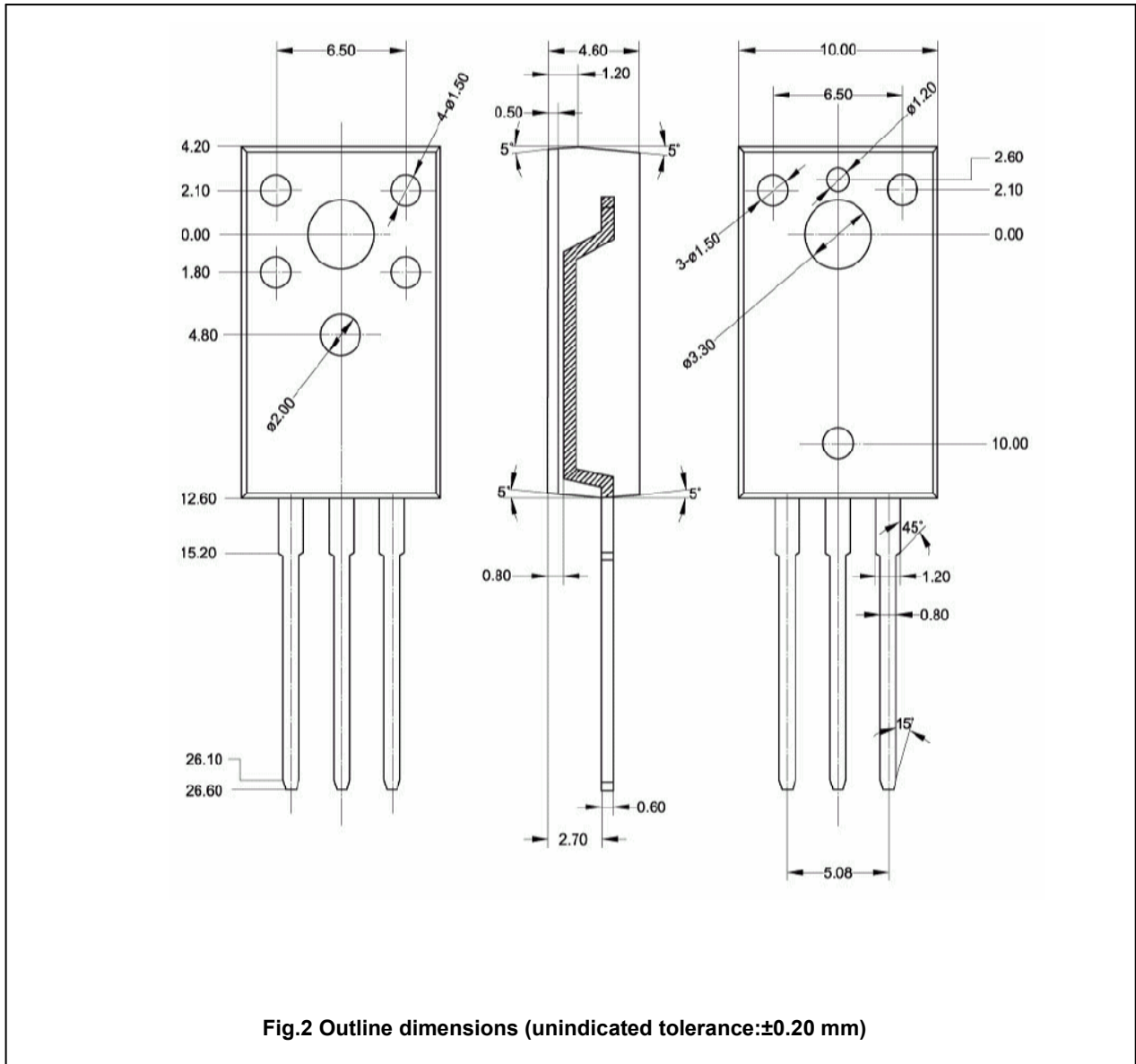

Fig.2 Outline dimensions (unindicated tolerance: ± 0.20 mm)