

COMPOUND FIELD EFFECT POWER TRANSISTOR
 μ PA1601

MONOLITHIC POWER MOS FET ARRAY

www.DataSheet4U.net

DESCRIPTION

The μ PA1601 is Monolithic N-channel Power MOS FET Array that built in 7 circuits and resistance designed for LED, Relay, Thermal Head, and so on.

FEATURES

- Direct driving is possible by standard Logic IC or Microcomputer. (4 V driving is possible)
- Output Voltage: $V_o = 30$ V MAX.
Output Current: $I_o = 500$ mA MAX.
- $R_{on} = 3 \Omega$ TYP. at: $I_o = 150$ mA, $V_i = 4$ V
- Large Operation Temperature: -40 to $+85$ °C

ORDERING INFORMATION

Part Number	Package	Quality Grade
μ PA1601CX	16-Pin DIP	Standard
μ PA1601GS	16-Pin SOP	Standard

Please refer to "Quality grade on NEC Semiconductor Devices" (Document number IEI-1209) published by NEC Corporation to know the specification of quality grade on the devices and its recommended applications.

ABSOLUTE MAXIMUM RATINGS ($T_a = 25$ °C)

Output Voltage	$V_{O(DC)}$	30	V
Output Peak Voltage*	$V_{O(peak)}$	50	V
Input Voltage	V_i	-0.5 to $+20$	V
Output Current (DC)	$I_{O(DC)}$	430	mA/unit
Output Current (pulse)**	$I_{O(pulse)}$	500	mA/unit
Input Current	I_i	± 10	mA/unit
Total Power Dissipation	P_T	1.0	W/PKG
Operating Temperature	T_{opt}	-40 to $+85$	°C
Storage Temperature	T_{stg}	-55 to $+150$	°C

* $PW \leq 10$ ms, Duty Cycle ≤ 10 %

** $PW \leq 10$ ms, Duty Cycle ≤ 30 %

CONNECTION DIAGRAM

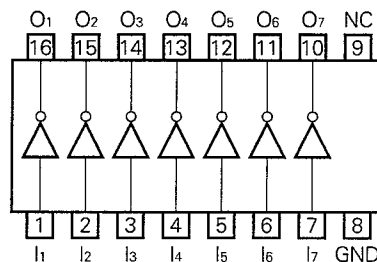

I : Input
O : Output

Equivalent Circuits (1 unit)

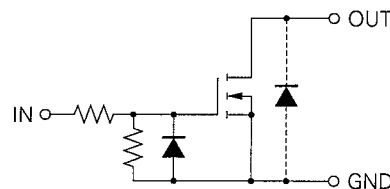

RECOMMENDED OPERATING CONDITIONS (T_a = -40 to +85 °C)

CHARACTERISTIC	SYMBOL	MIN.	TYP.	MAX.	UNIT	TEST CONDITIONS
Output Voltage	V _{O(DC)}			24	V	
Output Current	I _o			270	mA/unit	DC, 1 circuit
	I _{O(pulse)}			200	mA/unit	PW ≤ 10 ms, Duty Cycle ≤ 25 %, 7 circuits
Input Voltage	V _I	0		15	V	
High-Level Input Voltage	V _{IH}	2			V	
Low-Level Input Voltage	V _{IL}			0.8	V	

ELECTRICAL CHARACTERISTICS (T_a = 25 °C)

CHARACTERISTIC	SYMBOL	MIN.	TYP.	MAX.	UNIT	TEST CONDITIONS
Output Leakage Current	I _{O(OFF)}			10	μA	V _I = 0, V _O = 30 V
Output On-state Resistance	R _{on}		3	5.3	Ω	V _I = 4 V, I _o = 150 mA
Output On-state Voltage	V _{O(ON)1}			0.2	V	V _I = 5 V, I _o = 10 mA
	V _{O(ON)2}			0.8	V	V _I = 5 V, I _o = 150 mA
Input Voltage	V _{I(OFF)}			0.8	V	V _O = 50 V, I _o = 100 μA
	V _{I(ON)1}	2			V	V _O = 0.8 V, I _o = 1 mA
	V _{I(ON)2}	4			V	V _O = 0.8 V, I _o = 150 mA
Input Current	I _{IH}			2	mA	V _I = 20 V, V _O = 0 V
	I _{IL}			-1	μA	V _I = 0 V, V _O = 50 V
Input Capacitance	C _{iss}		15		pF	V _I = 0 V
Output Capacitance	C _{oss}		18		pF	V _O = 10 V
Reverse Transfer Capacitance	C _{rss}		34		pF	f = 1 MHz
Delay Time	t _{PHL}		10		ns	V _{CC} = 10 V, R _L = 100 Ω C _L = 15 pF t _r , t _f ≤ 5 ns See Fig. 1
	t _{PLH}		110		ns	
Rise Time	t _{TLH}		90		ns	
Fall Time	t _{THL}		20		ns	

Fig. 1 Switching Wave Forms and Test Circuits

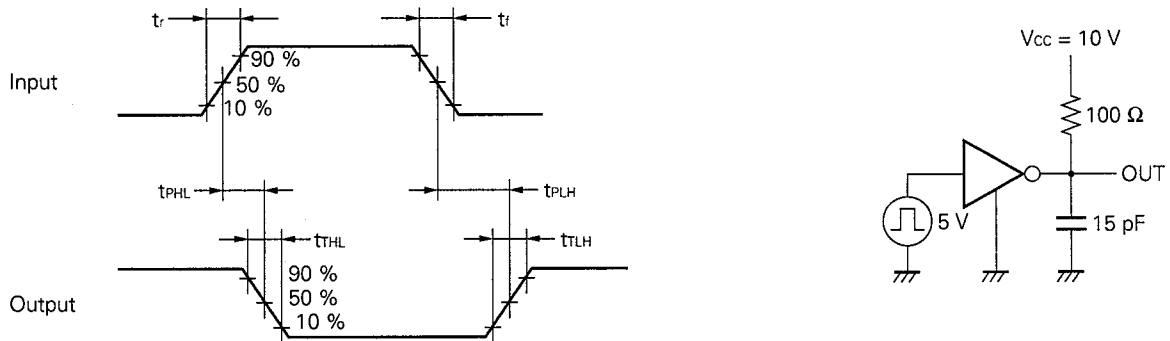

TYPICAL CHARACTERISTICS ($T_a = 25^\circ\text{C}$)

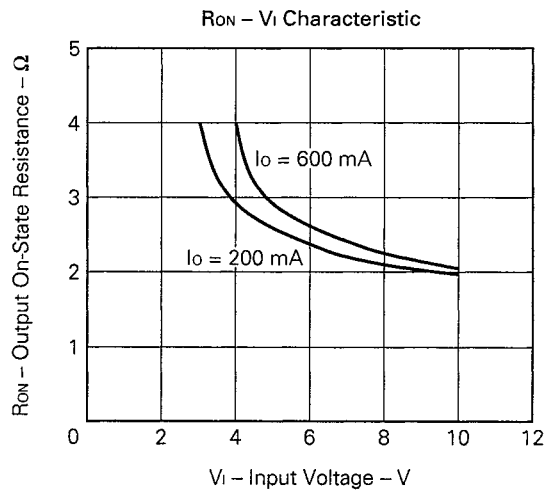
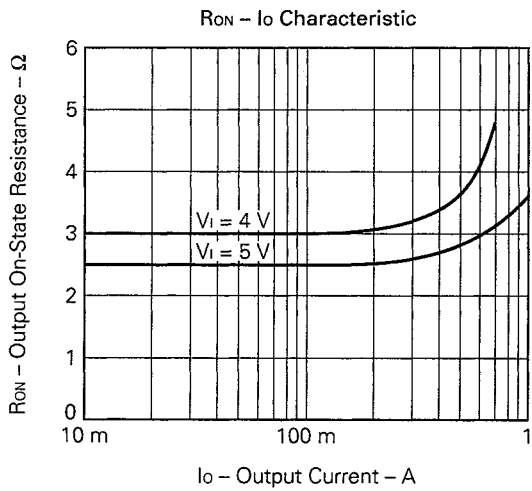
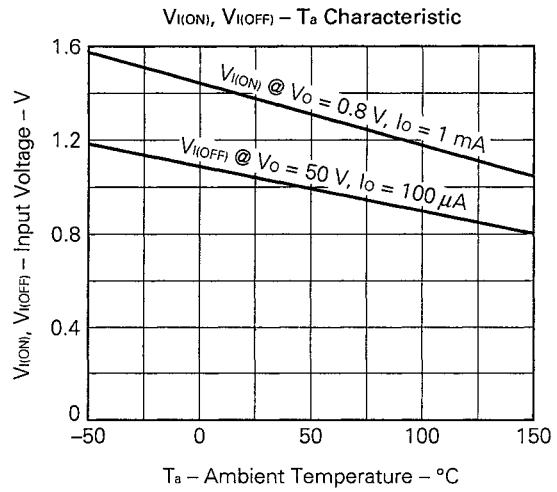
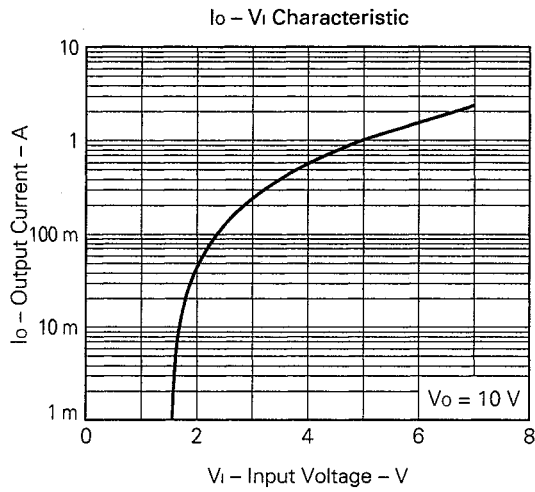
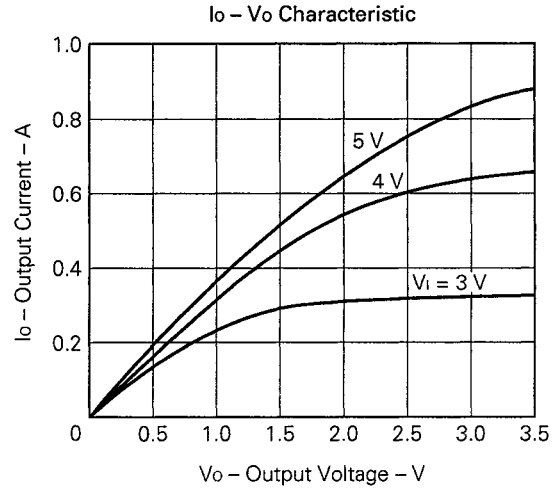
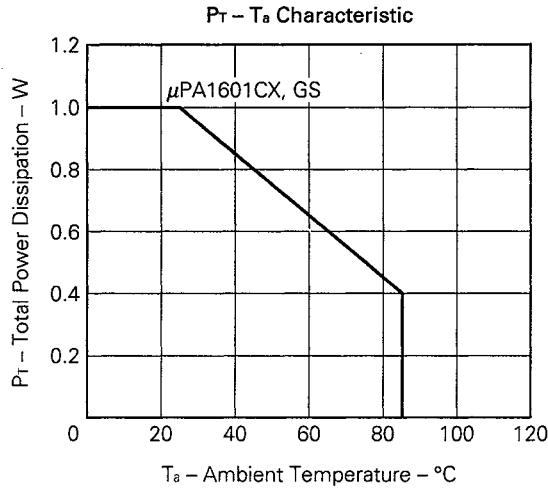

$R_{ON} - T_a$ Characteristic

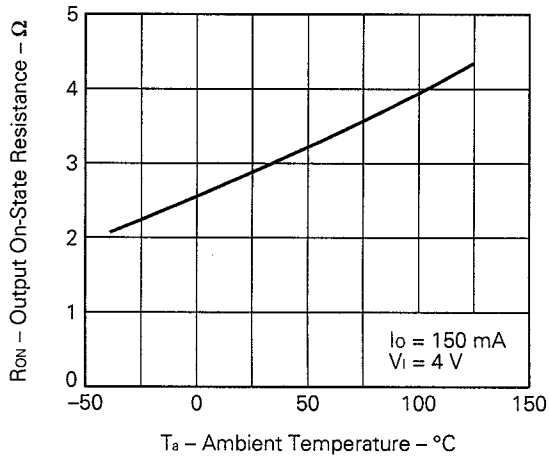

$I_{SD} - V_{SD}$ Characteristic

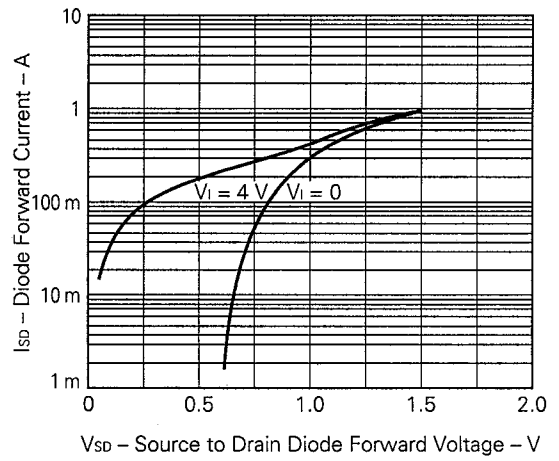

$C_{iss}, C_{oss} - V_o$ Characteristic

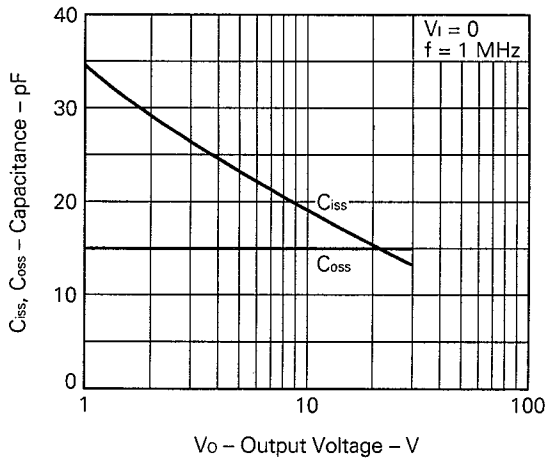

$t_{PHL}, t_{PLH}, t_{THL}, t_{TLH} - I_o$ Characteristic

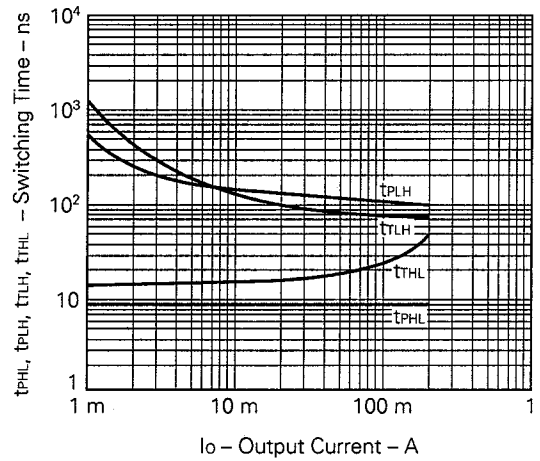

PACKAGE DIMENSIONS

• μPA1601CX

16PIN PLASTIC DIP (300 mil)

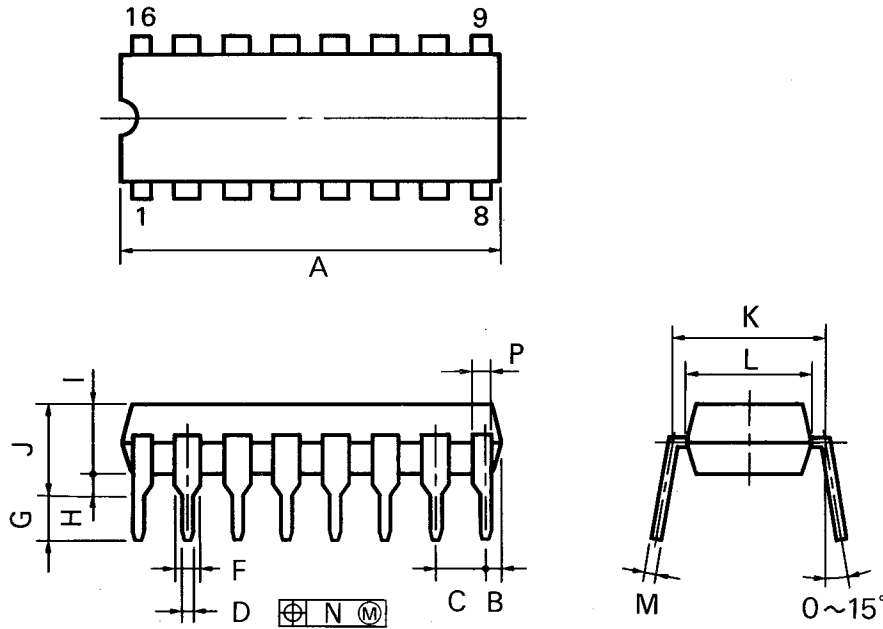

P16C-100-300A,C

NOTES

- 1) Each lead centerline is located within 0.25 mm (0.01 inch) of its true position (T.P.) at maximum material condition.
- 2) Item "K" to center of leads when formed parallel.

ITEM	MILLIMETERS	INCHES
A	20.32 MAX.	0.800 MAX.
B	1.27 MAX.	0.050 MAX.
C	2.54 (T.P.)	0.100 (T.P.)
D	0.50 ^{+0.10}	0.020 ^{+0.004} _{-0.005}
F	1.2 MIN.	0.047 MIN.
G	3.5 ^{±0.3}	0.138 ^{±0.012}
H	0.51 MIN.	0.020 MIN.
I	4.31 MAX.	0.170 MAX.
J	5.08 MAX.	0.200 MAX.
K	7.62 (T.P.)	0.300 (T.P.)
L	6.4	0.252
M	0.25 ^{+0.10} _{-0.05}	0.010 ^{+0.004} _{-0.003}
N	0.25	0.01
P	1.0 MIN.	0.039 MIN.

• μPA1601GS

16 PIN PLASTIC SOP (300 mil)

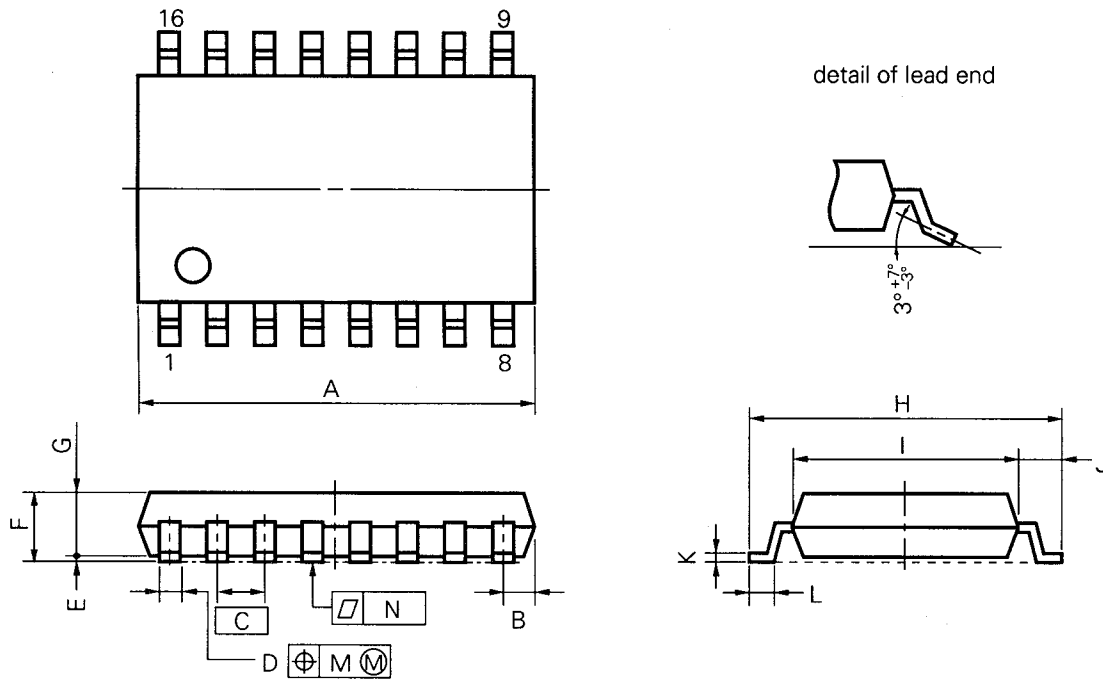

P16GM-50-300B-3

NOTE

Each lead centerline is located within 0.12 mm (0.005 inch) of its true position (T.P.) at maximum material condition.

ITEM	MILLIMETERS	INCHES
A	10.46 MAX.	0.412 MAX.
B	0.78 MAX.	0.031 MAX.
C	1.27 (T.P.)	0.050 (T.P.)
D	0.40 ^{+0.10} / _{-0.05}	0.016 ^{+0.004} / _{-0.003}
E	0.1±0.1	0.004±0.004
F	1.8 MAX.	0.071 MAX.
G	1.55	0.061
H	7.7±0.3	0.303±0.012
I	5.6	0.220
J	1.1	0.043
K	0.20 ^{+0.10} / _{-0.05}	0.008 ^{+0.004} / _{-0.002}
L	0.6±0.2	0.024 ^{+0.008} / _{-0.009}
M	0.12	0.005
N	0.10	0.004

RECOMMENDED SOLDERING CONDITIONS

The following conditions (see table below) must be set when soldering this product.

Please consult with our sales offices in case other soldering process is used, or in case soldering is done under different conditions.

TYPES OF SURFACE MOUNT DEVICE

For more details, refer to our document "SEMICONDUCTOR DEVICE MOUNTING TECHNOLOGY MANUAL" (IEI-1207).

μPA1601GS

Soldering process	Soldering conditions	Symbol
Infrared ray reflow	Peak package's surface temperature: 235 °C or below, Reflow time: 30 seconds or below (210 °C or higher), Number of reflow process: Inside of 2 times, Exposure limit*: None	IR35-00-1
VPS	Peak package's surface temperature: 215 °C or below, Reflow time: 40 seconds or below (200 °C or higher), Number of reflow process: Inside of 2 times, Exposure limit*: None	VP15-00-2
Wave soldering	Solder temperature: 260 °C or below, Flow time: 10 seconds or below, Number of flow process: 1, Exposure Limit*: None	WS60-00

*: Exposure limit before soldering after dry-pack package is opened.

Storage conditions: 25 °C and relative humidity at 65 % or less.

Note: Do not apply more than a single process at once, except for "Partial heating method".

TYPES OF THROUGH HOLE MOUNT DEVICE

μPA1601CX

Soldering process	Soldering conditions	Symbol
Wave soldering	Solder temperature: 260 °C or below, Flow time: 10 seconds or below	

Reference

Document name	Document No.
Quality control of NEC semiconductors devices.	TEI-1202
Quality control guide of semiconductors devices.	MEI-1202
Assembly manual of semiconductors devices.	IEI-1207
Semiconductor device package manual	IEI-1213
SMD surface mount technology manual	IEI-1207

[MEMO]

No part of this document may be copied or reproduced in any form or by any means without the prior written consent of NEC Corporation. NEC Corporation assumes no responsibility for any errors which may appear in this document.

NEC Corporation does not assume any liability for infringement of patents, copyrights or other intellectual property rights of third parties by or arising from use of a device described herein or any other liability arising from use of such device. No license, either express, implied or otherwise, is granted under any patents, copyrights or other intellectual property rights of NEC Corporation or others.

The devices listed in this document are not suitable for use in aerospace equipment, submarine cables, nuclear reactor control systems and life support systems. If customers intend to use NEC devices for above applications or they intend to use "Standard" quality grade NEC devices for applications not intended by NEC, please contact our sales people in advance.

Application examples recommended by NEC Corporation.

Standard: Computer, Office equipment, Communication equipment, Test and Measurement equipment, Machine tools, Industrial robots, Audio and Visual equipment, Other consumer products, etc.

Special: Automotive and Transportation equipment, Traffic control systems, Antidisaster systems, Anticrime systems, etc.