



EVERLIGHT ELECTRONICS CO.,LTD.

Device Number : CDAE-189-003 REV: 1

MODEL NO : A1893B/6VY ECN : _____ Page: 1/6

■ Package Dimensionas:

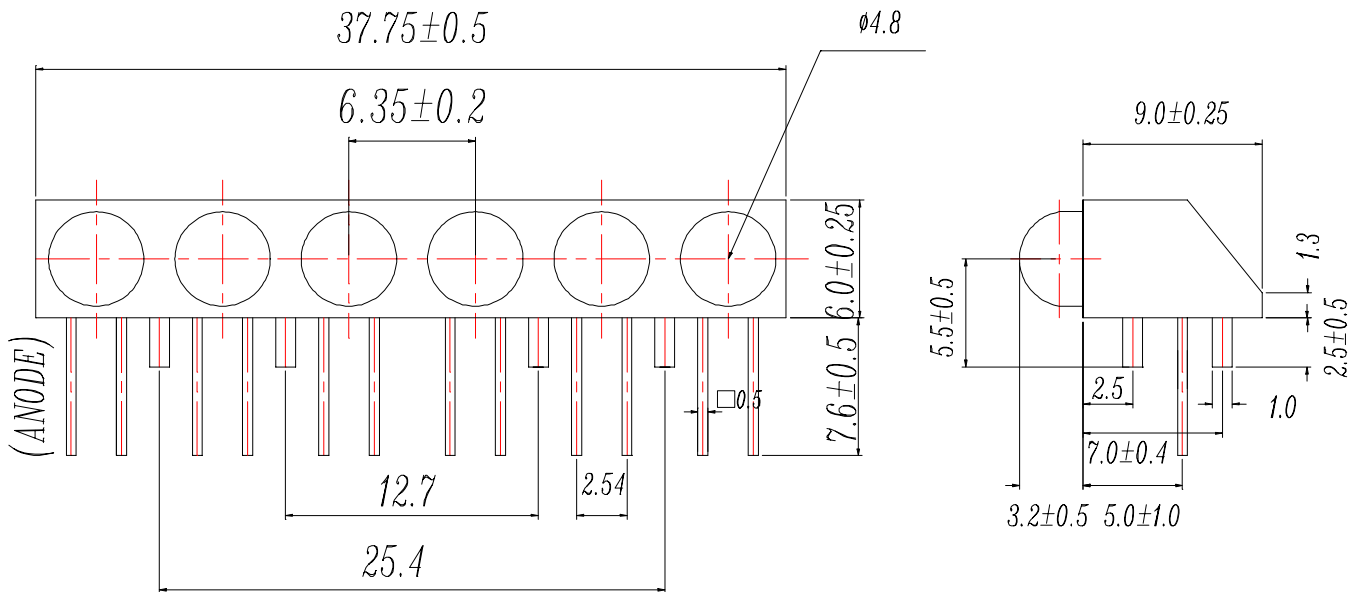

■ Notes:

- 1.All dimensions are in millimeters, tolerance is 0.25mm except being specified
- 2.Lead spacing is measured where the lead emerge from the package

LED PART NO	Chip		Lens Color
	Material	Emitted Color	
313VYD	GaAsP/GaP	Yellow	Yellow Diffused

OFFICE : NO. 25,Lane 76,Sec.3, Chung Yang Rd., Tucheng 236, Taipei, Taiwan, R.O.C.

TEL : 886-2-2267-2000,2267-9936

FAX : 886-2-2267-6244,22676189,22676306

<http://www.everlight.com>



EVERLIGHT ELECTRONICS CO.,LTD.

Device Number : CDAE-189-003 REV: 1

MODEL NO : A1893B/6VY ECN : Page: 2/6

■ Descriptions:

- 1.ARRAY=Plastic Holder+Combinations of Lamp
- 2.The array will easily mount the applicable lamps on any panel up to

■ Features:

- 1.Low power consumption
- 2.High efficiency and low cost
- 3.Good control and free combinations on the colors of LED lamps
- 5.Good lock and easy to assembly
- 6.Stackable and easy to assembly
- 7.Stackable vertically and easy to assembly
- 8.Versatile mounting on P.C board or panel
- 9.Stackable horizontally and easy to assembly

■ Applications:

- 1.Used as indicators of indicating the Degree, Functions, Positions etc, in electronic instruments.



EVERLIGHT ELECTRONICS CO.,LTD.

Device Number : CDAE-189-003 REV: 1

MODEL NO : A1893B/6VY ECN : _____ Page: 3/6

■ LED LAMP ARRAYS SELECTION GUIDE:

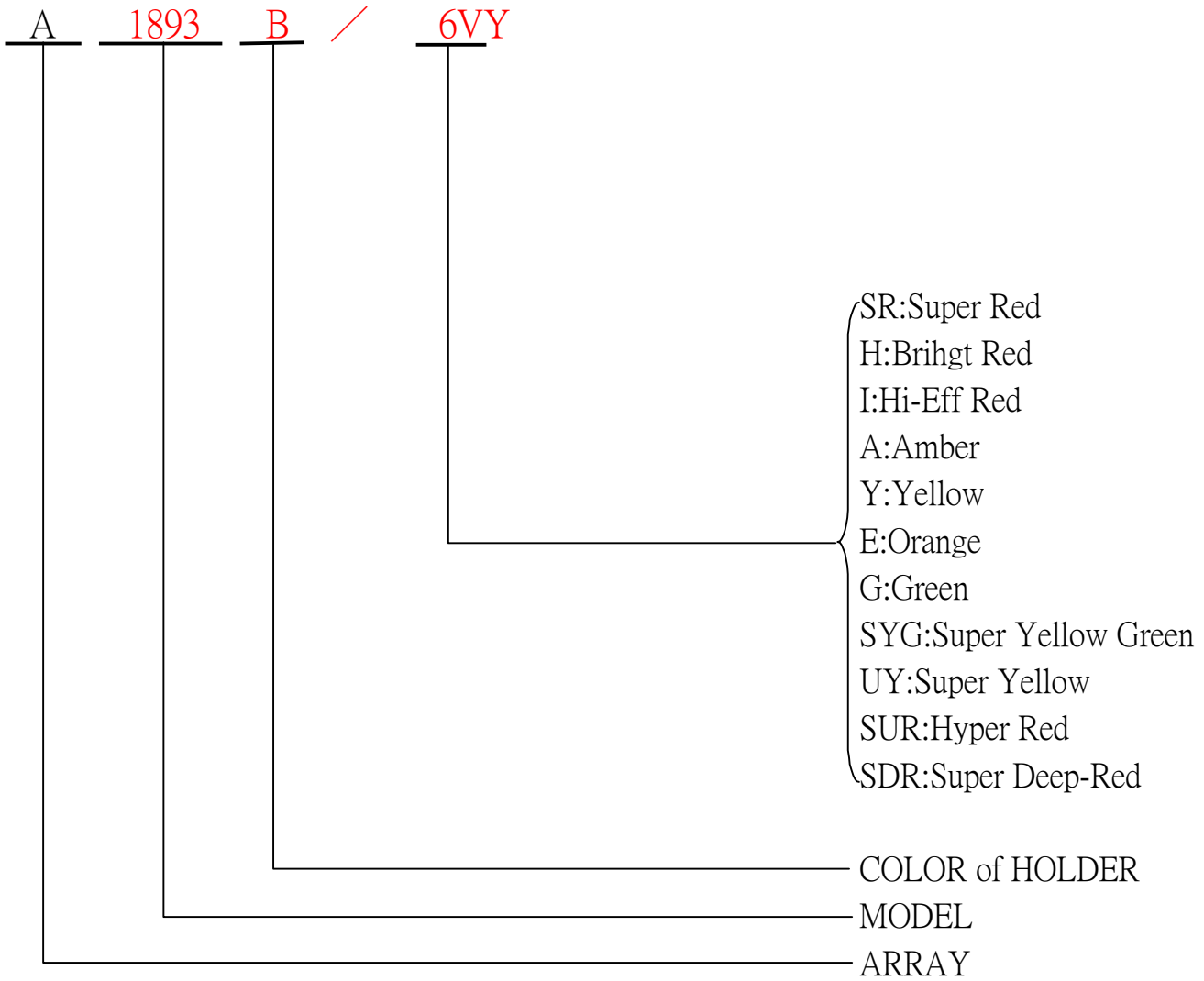



EVERLIGHT ELECTRONICS CO.,LTD.

Device Number : CDAE-189-003 REV: 1

MODEL NO : A1893B/6VY ECN : Page: 4/6

Absolute Maximum Ratings at Ta = 25°C

Parameter	Symbol	Rating	Unit
Forward Current	IF	30	mA
Operating Temperature	Topr	-40 to +85	°C
Storage Temperature	Tstg	-40 to +100	°C
Soldering Temperature	Tsol	260 ± 5	°C
Power Dissipation	Pd	85	mW
Peak Forward Current(Duty 1/10 @ 1KHZ)	IF(Peak)	160	mA
Reverse Voltage	VR	5	V

Electronic Optical Characteristics :

Parameter	Symbol	Min	Typ	Max	Unit	Condition
Luminous Intensity	Iv	4.00	12.50	/	mcd	IF= 20 mA
Viewing Angle	2θ 1/2	/	60	/	deg	IF= 20 mA
Peak Wavelength	λ p	/	585	/	nm	IF= 20 mA
Dominant Wavelength	λ d	/	590	/	nm	IF= 20 mA
Spectrum Radiation Bandwidth	Δ λ	/	35	/	nm	IF= 20 mA
Forward Voltage	VF	1.7	2.0	2.4	V	IF= 20 mA
Reverse Current	IR	/	/	10	μ A	VR= 5 V



■ Typical Electro-Optical Characteristic Curves:

(VY)

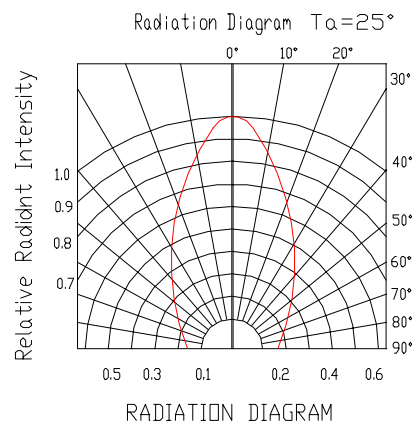
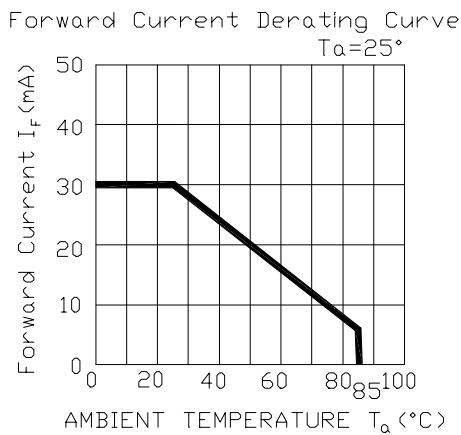
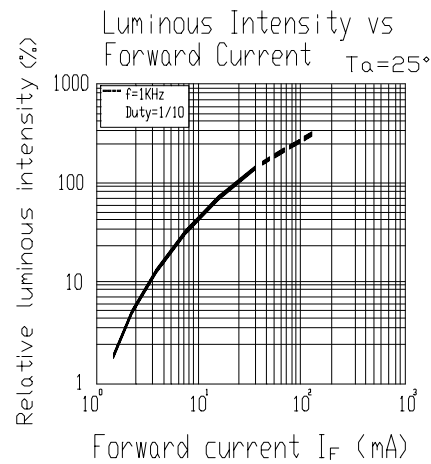
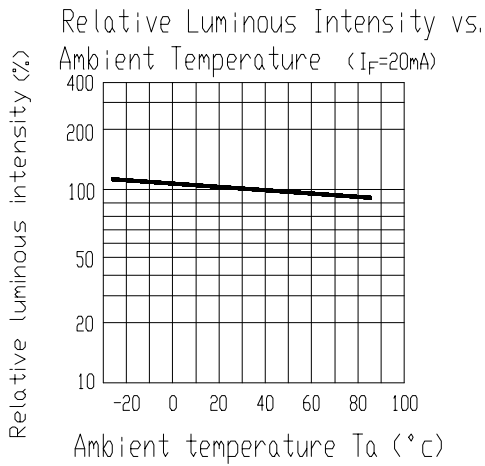
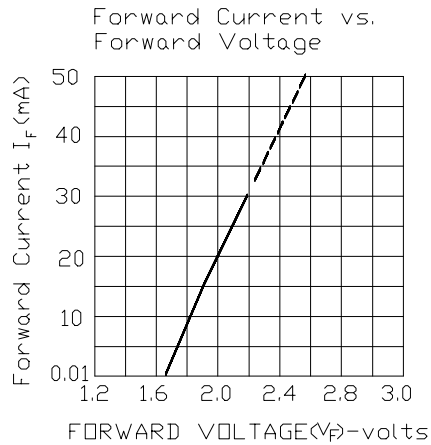
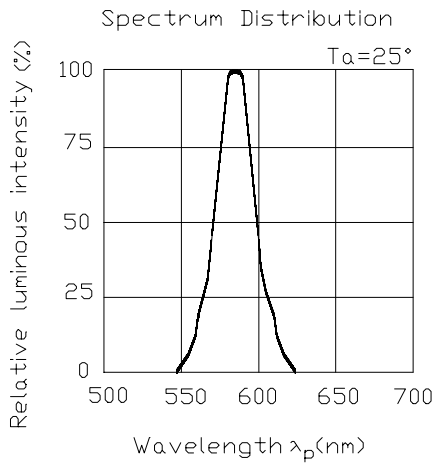



EVERLIGHT ELECTRONICS CO.,LTD.

Device Number : CDAE-189-003 REV: 1

MODEL NO : A1893B/6VY ECN : Page: 6/6

■ Reliability test items and condition

No	Item	Test Conditions	Test Hours/Cycle	Sample Size	Ac/Re
1	Solder Heat	TEMP : 260°C ± 5 °C	5 SEC	76 PCS	0/1
2	Temperature Cycle	H : +85°C 30min ┆ 5 min L : -55°C 30min	50 CYCLE	76 PCS	0/1
3	Thermal Shock	H : +100°C 5min ┆ 10 sec L : -10°C 5min	50 CYCLE	76 PCS	0/1
4	High Temperature Storage	TEMP : 100°C	1000 HRS	76 Pcs	0/1
5	Low Temperature Storage	TEMP : -55°C	1000 HRS	76 PCS	0/1
6	DC Operating Life	IF = 20 mA	1000 HRS	76 PCS	0/1
7	High Temperature / High Humidity	85°C/85% RH	1000 HRS	76 PCS	0/1