

331 478 to 545

**CRYDOM**  
COMPANY

BULLETIN 801C

**SERIES 1**  
SCR Output  
Solid-State Relays

2.5 Thru 90 Amp  
24-480 VAC Output

**General Description**

Crydom's Series 1 premium line, solid-state power relays incorporate inverse-parallel SCR output devices in the original standard Crydom package with the same highly reliable, noise-immune drive circuitry that has been a Crydom feature for more than a decade. Snubbers are included for high dv/dt applications and inductive loads, with a choice of models offering zero-voltage switching to reduce high inrush currents and electrical noise or Phase Controllable models for random turn-on.

The oversized output chips, together with the Crydom optimized thermal management system, allows a narrower band of temperature excursions, resulting in a significant reduction in thermal cycling fatigue, thereby extending relay life. These premium devices are recommended for use in high temperature, highly inductive load situations where the ultimate in thermal and surge performance is required.

**Zero Voltage Models**

The inherent zero-current turn-off characteristic of SCRs, and the total absence of arcing mechanical contacts, substantially reduces electro-magnetic interference and back EMF transients. AC input models can be controlled from a wide range of AC Signal Sources (90-280 VAC), and are available in Form A (normally open) configuration only. DC input versions will operate from IC logic signals, and are available in either Form A (SPST-normally open) or Form B (SPST, normally closed) output configurations.

**Phase Controllable Models**

The -10 versions of DC Input Series 1 Relays are "non-zero voltage" (random) turn-on types, and are optimized for operation from a phase-controlled signal applied at each half of the line cycle. They have been designed for phase control of incandescent lamps or any load with a power factor between 0.6 and 1.0.

**Wiring Diagram**

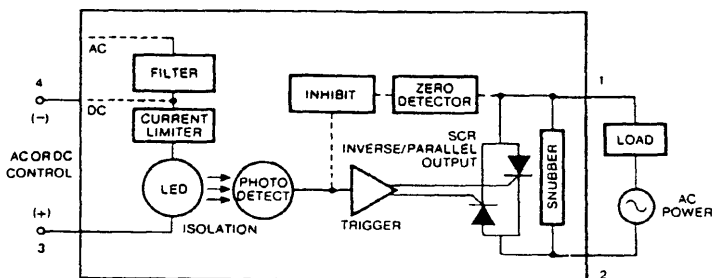

- Opto-Isolated 4000 VRMS ■
- Random and Zero Voltage Switching (AC) ■
- Form A and B Output Switching ■
- U.L., CSA and VDE Approved ■
- Superior Thermal and Surge Ratings ■
- AC and DC Wide Control Range ■
- 400 Hz Relays Available ■

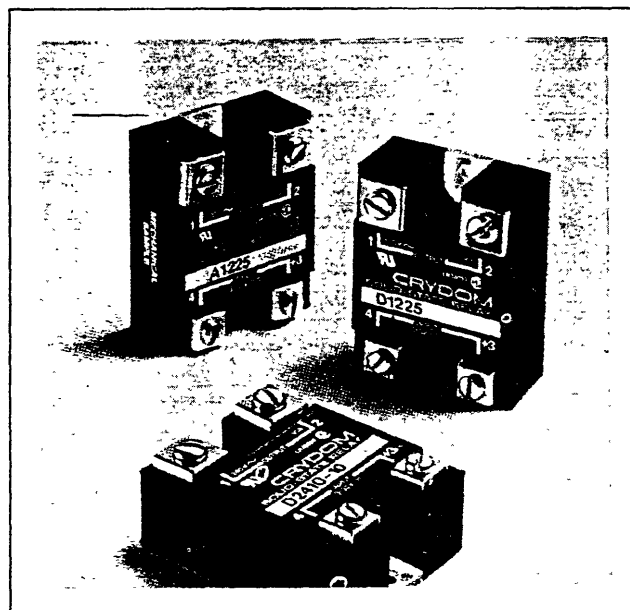

**Part Numbering**

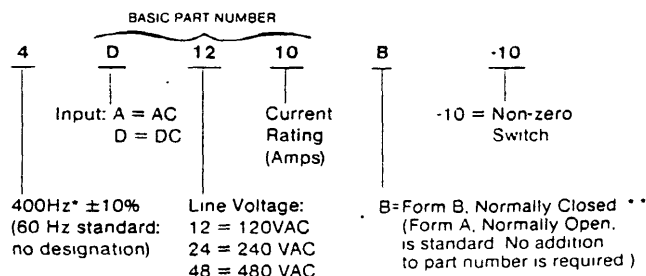

\*Available with "D12-, D24-" prefix, 2.5 thru 40 Amps only  
\*\*Available with all "D prefixes" 8 thru 40 Amps only

Input Control Models. DC Input Control Models. Phase-Controlled Models.

90 amp models available

120 VAC			240 VAC						480 VAC						UNITS
A1210	A1225	A1240	A2402	A2410	A2425	A2440	A2450	A2475	A4808	A4812	A4825	A4840	A4850	A4875	
D1210	D1225	D1240	D2402	D2410	D2425	D2440	D2450	D2475	D4808	D4812	D4825	D4840	D4850	D4875	
D1210-10	D1225-10	D1240-10	—	D2410-10	D2425-10	D2440-10	D2450-10	D2475-10	—	—	D4825-10	D4840-10	—	D4875-10	
24-140			48-280						80-530						V <sub>(RMS)</sub>
45-140			90-280						180-530						V <sub>(RMS)</sub>
10	25	40	2.5	10	25	40	50	75	8	12	25	40	50	75	A <sub>(RMS)</sub>
40			40						40						mA <sub>(RMS)</sub>
400			600						800						V <sub>(peak)</sub>
120	250	625	22.5	120	250	625	625	1000	72	140	250	625	625	1000	A <sub>(peak)</sub>
22	40	80	5	22	40	80	80	150	17	24	40	80	80	150	A <sub>(RMS)</sub>
1.6			3.5						1.6						V <sub>(peak)</sub>
60	260	1620	2.1	60	260	1620	1620	4150	22	81	260	1620	1620	4150	A <sup>2</sup> /sec
1.48	1.02	0.63	8.5	1.48	1.02	0.63	0.63	0.31	1.48	1.48	1.02	0.63	0.63	0.31	°C/W
12	29	46	6.3	12	29	46	55	82	7.8	14	29	46	55	82	Watts
15			30						75						V <sub>(peak)</sub>
10			12						35						V <sub>(peak)</sub>
8			10						10						mA <sub>(RMS)</sub>
500			500						500						V/μs

DC INPUT MODELS (WITH "D" PREFIX)	AC INPUT MODELS (WITH "A" PREFIX)	PHASE CONTROLLED MODELS (WITH "-10")
3 to 32 VDC	90 to 280 V <sub>(RMS)</sub> (60 Hz)	3.5 to 26 VDC
-32 VDC	—	20 VDC
3.0 VDC	90 V <sub>(RMS)</sub>	3.5 VDC
1.0 VDC	10 V <sub>(RMS)</sub>	1.0 VDC
1500 OHMS	60K OHMS	1K OHMS
3.4mA(@ 5 VDC) 20mA (@ 28 VDC)	2mA(@ 120 VAC) 4mA(@ 240 VAC)	5mA (@ 5 VDC) 20mA (@ 20 VDC)
8.3 msec	10 msec	20 μsec
8.3 msec	40 msec	8.3 msec
—	—	100 μsec
—	—	50 μsec
—	—	@ LINE = 120 V <sub>(RMS)</sub> ..... 500 μsec
—	—	@ LINE = 240 V <sub>(RMS)</sub> ..... 600 μsec
—	—	@ LINE = 480 V <sub>(RMS)</sub> ..... 1 msec

4000 V <sub>(RMS)</sub> .		
10 <sup>10</sup> OHMS		
8 pf		
-30°C to 80°C	-30°C to 80°C	0°C to 80°C
-40°C to 120°C		

**CRYDOM**  
COMPANY

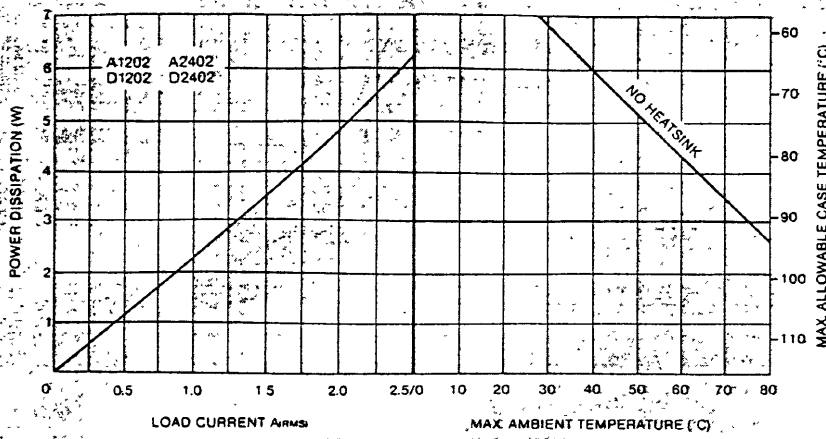

Figure 4. Thermal Derating Curves: 2.5 Amp, 120 and 240V.

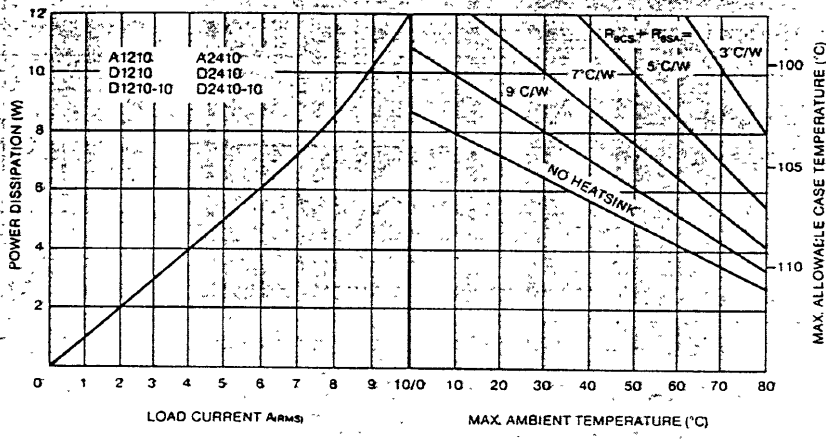

Figure 5. Thermal Derating Curves: 10 Amp, 120 and 240V.

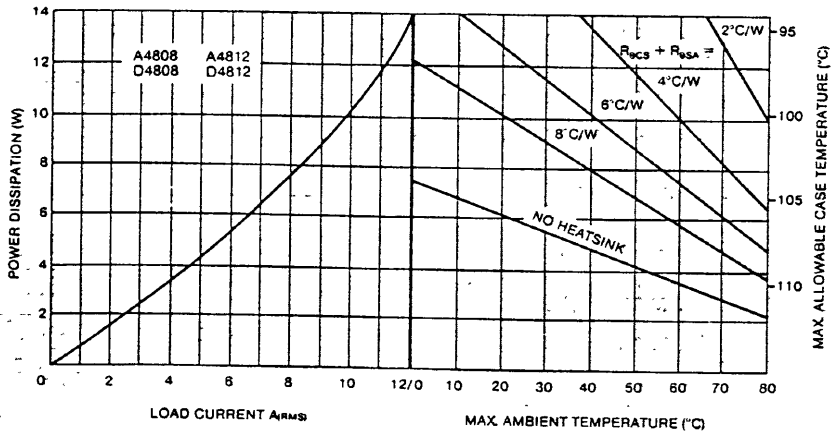

Figure 6. Thermal Derating Curves: 8 and 12 Amp, 480V.

### SURGE CHARACTERISTICS

The curves in figures A,B,C,D and E apply to a non-repetitive uniform amplitude surge of a given time and peak current, preceded and followed by any rated load condition. Also shown is the number of these surge occurrences that can be tolerated before device damage. For example, for a D1210, a life of  $10^4$  surge occurrences can be estimated for a 25 Amp peak surge, (250% of steady-state) of 0.6 seconds duration (Figure B). The junction temperature must be allowed to return to its steady-state value before reapplication of surge current.

Control of conduction may be momentarily lost if currents exceed the  $10^4$  curve values from initial junction temperatures greater than  $40^\circ\text{C}$ .

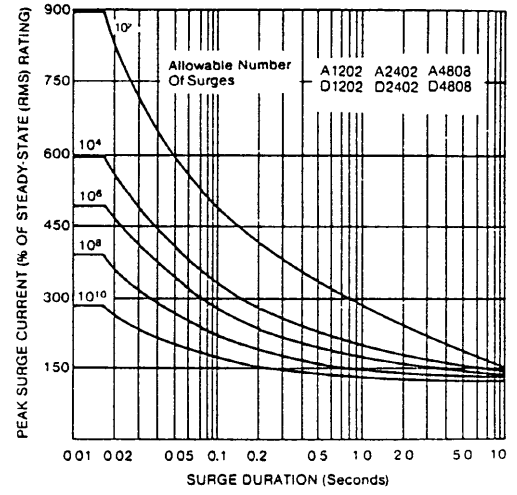

Figure A. Peak Surge Current vs Duration 2 and 8 Amp Models.

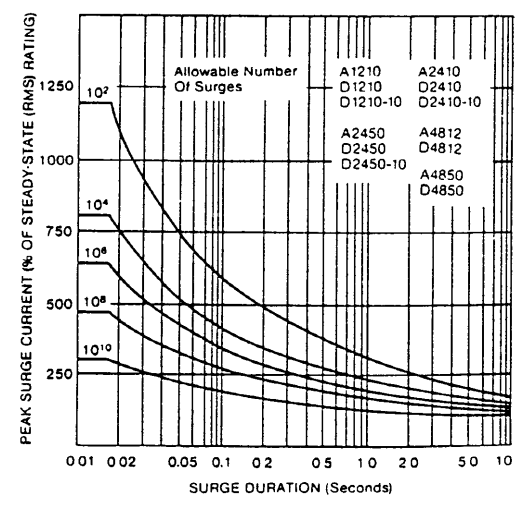

Figure B. Peak Surge Current vs Duration 10, 12 and 50 Amp Models

**PHASE-CONTROL CHARACTERISTICS**  
 ("10" MODELS).

When used for phase control, inductive loads may give rise to "ringing" and voltage "overshoot" that could exceed the relay's peak transient rating. If this occurs, consideration might be given to the use of a metal oxide varistor (MOV) transient suppressor to protect the relay.

In addition to the pulse width requirement, the pulse termination ( $T_{PT}$ ) and initiation ( $T_{PI}$ ) parameters must be satisfied. The zero current time ( $T_0$ ) is defined as that time when the current through the relay's output terminals passes through zero.

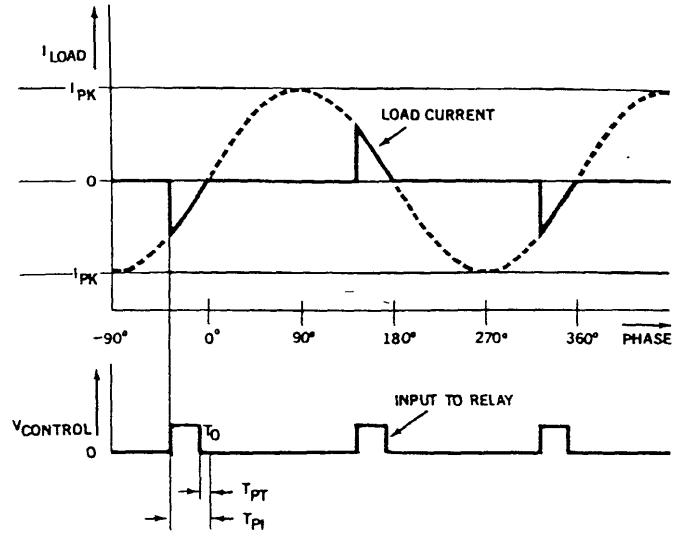
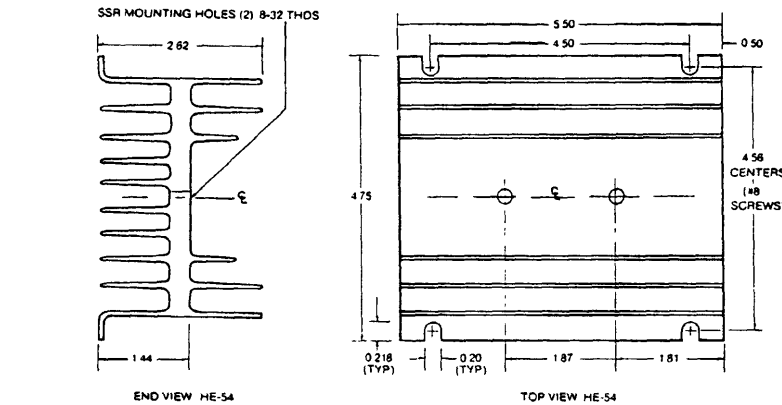
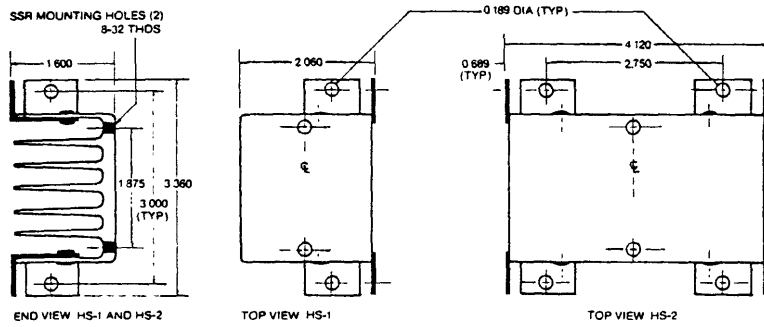

Figure 10 The relationship of zero current time, pulse termination time, and pulse initiation time to load current time

**HIGH EFFICIENCY HEAT SINKS**

MATERIAL: ALUMINUM  
 FINISH: CHROMATE COATING—GOLD



See Page 8 for a Simplified Heat Sink Selection Guide

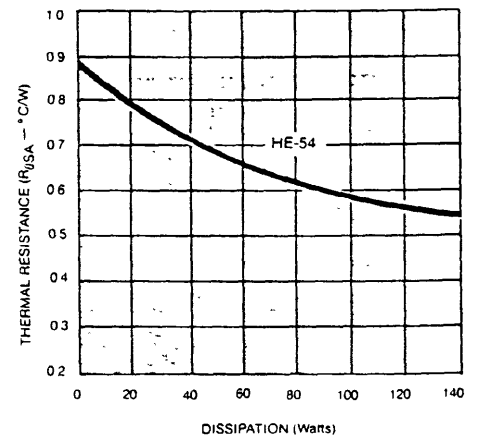
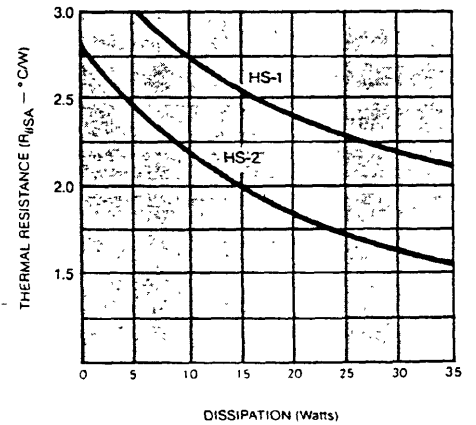

Typical Heat Sink Characteristics

**SIMPLIFIED HEAT SINK  
SELECTION GUIDE**

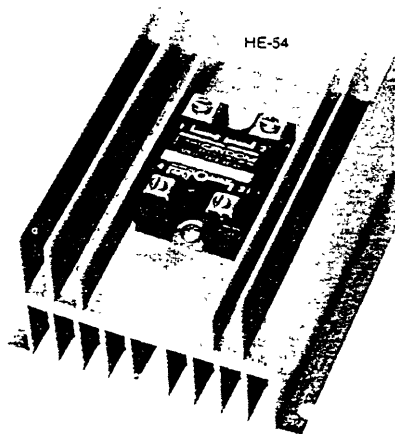

See Page 7 for Heat Sink  
Dimensions and Characteristics

Maximum Operating Current (SSR Rating)	Crydom Heatsink Type	Maximum Ambient Temperature (@ Max Current)
10A	HS-1	25° C
10A	HS-2	40° C
10A	6"x6"x1/8" (Alum)	40° C
25A	HS-2	25° C
25A	6"x6"x1/8" (Alum)	25° C
25A	12"x12"x1/8" (Alum)	40° C
50A	12"x12"x1/8" (Alum)	25° C
50A	HE-54	40° C
75A	HE-54	25° C
75A	HE-54 with 100 cfm air (muffin fan)	40° C

**NOTE** It is assumed that SSRs are mounted to flat surface using thermal compound and firmly torqued screws also that the finned heatsink or aluminum plate is mounted in vertical plane with unimpeded air flow on all surfaces

Dow Corning 340 thermal compound or equal is recommended between heat sink and relay case

**CRYDOM  
COMPANY**

**U.S.A.**

Crydom Company  
6015 Obispo Avenue  
Long Beach, CA 90805  
Phone: (213) 865-3536  
FAX: (213) 865-3318  
Telex 910 250 5756

**WEST GERMANY**

Crydom GMBH  
Quellenweg 9  
D6935 Waldbrunn 2  
Phone: 6274 6870  
FAX: 6274 1472  
Telex 17627492

**ENGLAND**

Crydom Ltd  
7 Redlands Centre  
Coulston  
Surrey CR5 2HT  
Tel: 081 763 0550  
FAX: 081 763 0499  
Telex: 911570 CRYDOM G

Sales Offices, Agents and Distributors in Major Cities throughout the World.

### Thermal Characteristics

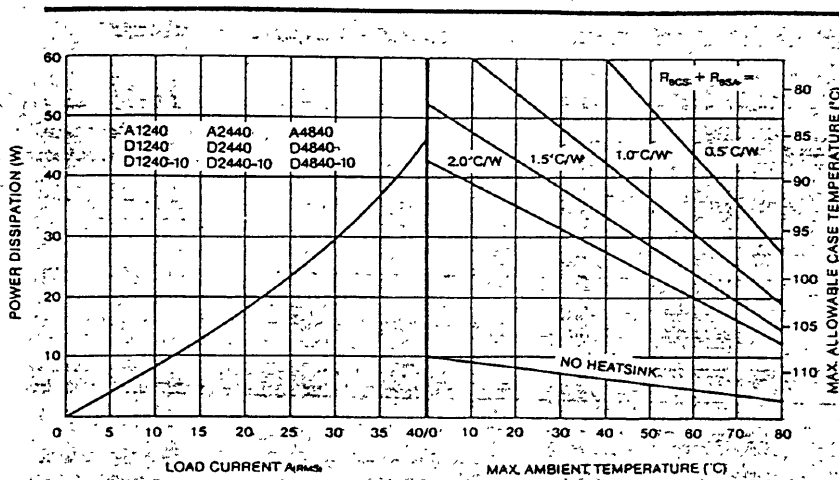

Figure 7. Thermal Derating Curves: 40-Amp, 120/240 and 480V.

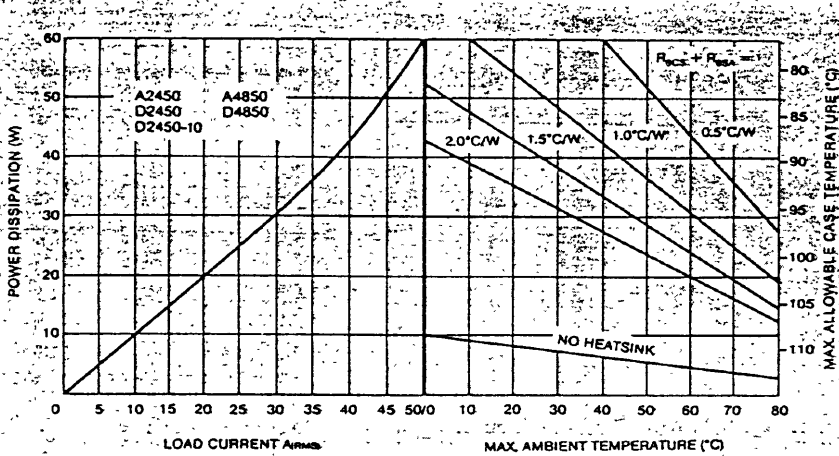

Figure 8. Thermal Derating Curves: 50 Amp, 240V.

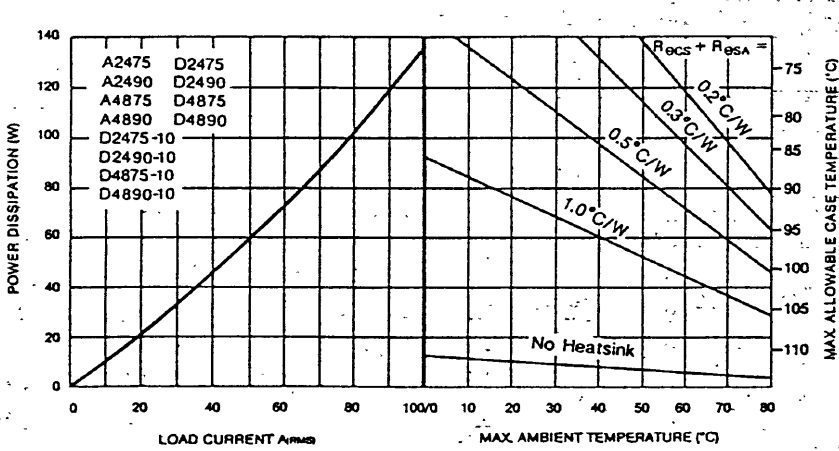

Figure 9. Thermal Derating Curves 75 & 90 Amp, 240 and 480V.

### Surge Characteristics

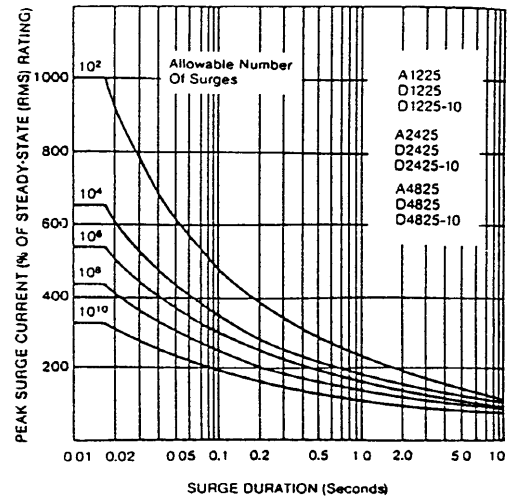

Figure C. Peak Surge Current vs. Duration: 25 Amp Models

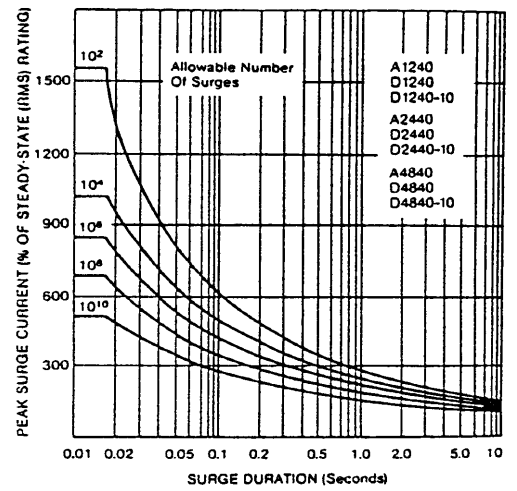

Figure D. Peak Surge Current vs. Duration: 40 Amp Models

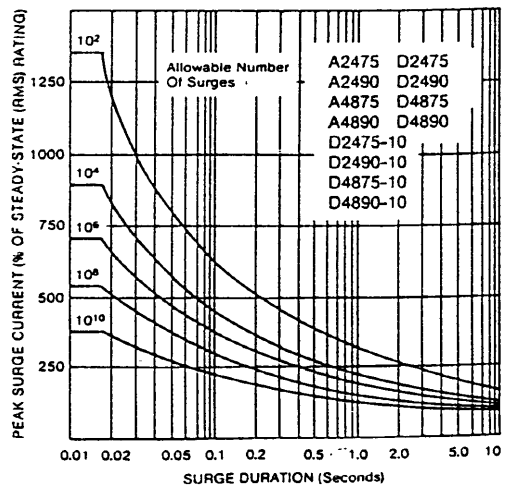

Figure E. Peak Surge current vs. Duration: 75 & 90 Amp Models.

## THERMAL CHARACTERISTICS

A major consideration in the use of solid-state relays is the thermal design. It is essential that the user provide adequate heat sinking for the application.

The simplified thermal model (Figure 1) indicates the basic elements to be considered in the thermal design. The values to be chosen or determined by the user are the case-to-heatsink interface thermal resistance ( $R_{\theta CS}$ ) and the heatsink-to-ambient thermal resistance ( $R_{\theta SA}$ ).

Referring to Figures 4 thru 9, the left halves show power dissipation versus load current. The right halves are families of curves which are used in selecting the required heatsink to maintain a maximum case temperature for a given ambient. It is important to note that the thermal resistance values ( $^{\circ}\text{C}/\text{W}$ ) shown include both case-to-heatsink interface ( $R_{\theta CS}$ ) as well as the heatsink-to-ambient thermal resistance ( $R_{\theta SA}$ ). Thus, when selecting a heatsink, the value of ( $R_{\theta CS}$ ) must be subtracted from the number indicated by the curve in order to determine the ( $R_{\theta SA}$ ).

As a point of information, if the SSR is firmly mounted on a smooth heatsink surface using thermally conductive grease, the value of  $R_{\theta CS}$  (case-to-heatsink interface) will typically be  $0.1^{\circ}\text{C}/\text{W}$  or less. Examples of how the curves are used are explained below in conjunction with Figure 3.

### Example 1

If a D1225 is mounted on a heatsink with a thermal resistance of  $1^{\circ}\text{C}/\text{W}$  (including  $R_{\theta CS}$ ) and must operate in an ambient of  $60^{\circ}\text{C}$ , the allowable current of 23A may be determined by following the route A,B,C,D (Figure 3). Additional information on power dissipation and maximum allowable case temperature can be found by extending line C,B to points E and F where the values of 26W and  $89^{\circ}\text{C}$  are read.

### Example 2

If a current of 17A is required for a D1225 in an ambient of  $55^{\circ}\text{C}$ , the necessary heatsink, plus interface, thermal re-

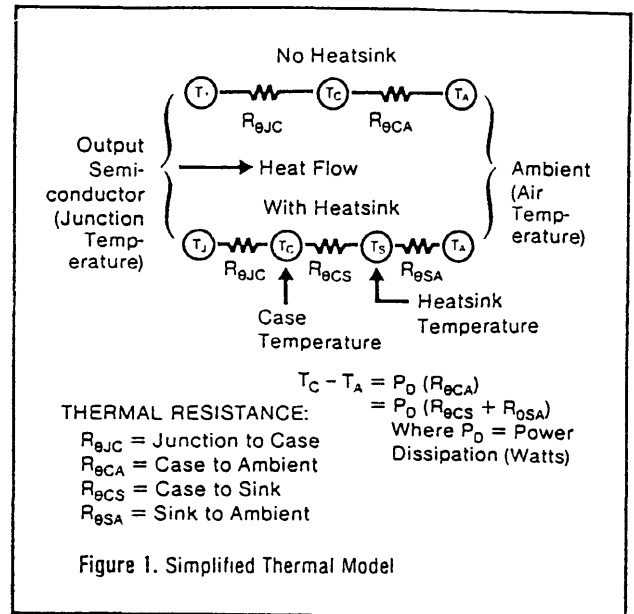

sistance of  $2.7^{\circ}\text{C}/\text{W}$  may be determined by following the route I,J,K,L (Figure 3). Additional information on power dissipation and case temperature can be found by extending line J,L to points M and N where the values of 16W and  $99^{\circ}\text{C}$  are read.

This information can be used in heatsink selection from manufacturer's dissipation versus thermal resistance curves such as those shown in Figure 2. The thermal resistance of curve (a) at 16 watts is  $2.5^{\circ}\text{C}/\text{W}$ . This is better than the required  $2.7^{\circ}\text{C}/\text{W}$  in example 2, allowing  $0.2^{\circ}\text{C}/\text{W}$  for  $R_{\theta CS}$ , and is therefore suitable for this application.

Alternatively, heatsink (b) at 16 watts is  $1.9^{\circ}\text{C}/\text{W}$ . Adding  $0.1^{\circ}\text{C}/\text{W}$  for  $R_{\theta CS}$  and returning to Figure 3, it would allow operation at a maximum ambient of  $65^{\circ}\text{C}$  instead of  $55^{\circ}\text{C}$ .

Confirmation of proper heatsink selection can be achieved by actual temperature measurement under worst case conditions. The measurement can be taken on the metal baseplate in the area of the mounting screw, and should not exceed the maximum allowable case temperature shown in graphs.

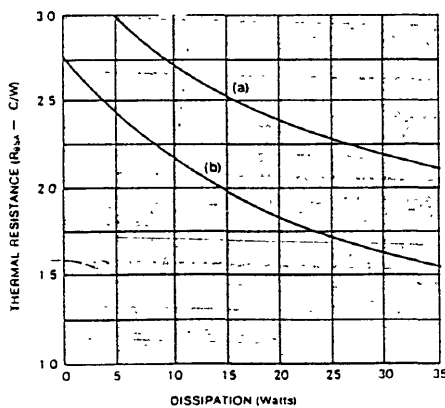

Figure 2. Typical Heat Sink Characteristics  
See Page 7

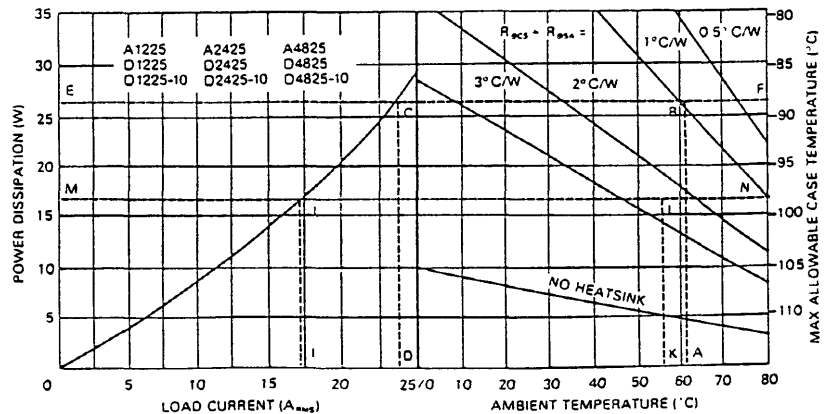

Figure 3. Use of Thermal Derating Curves: 25 Amps, 120, 240 and 480V (Examples.)

# SERIES 1 Solid-State Relays. Switch AC Power Loads up to 36 KW. AC

## MECHANICAL SPECIFICATIONS

Weight: 4 oz., Max. (75 & 90 Amp: 5 oz. Max.)  
 Case Material: Fire retardant polyester  
 Encapsulate: Alumina filled epoxy  
 Case Color: Black  
 Base Plate: Aluminum (Some models nickel-plated)  
 Terminals: Tin-plated Brass. Nickel-plated screws & saddle clamps supplied unmounted

## Dimensional Drawing

Tolerances:  $\pm 0.02$  (0.50) (unless otherwise noted)  
 Dimensions: Inches (mm)

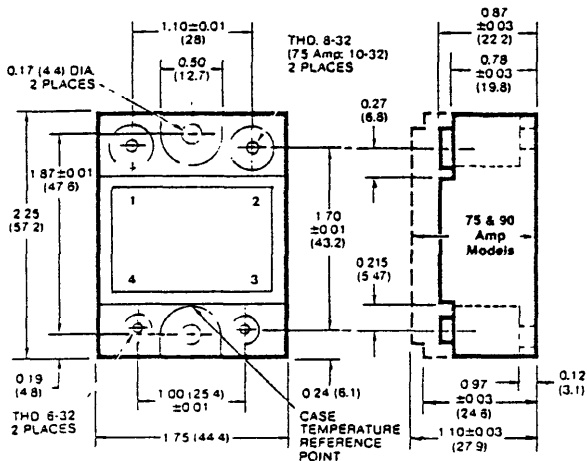

## General Notes

- ① Dielectric and insulation resistance measured for one minute between input and output 4000 V(RMS).
- ② Standard dielectric was formerly 2500 V(RMS). Previously required suffix (-20) for 4000 V(RMS) deleted.
- ③ 240V and 480V rated relays may be used at lower line voltages for higher transient immunity.
- ④ SCR output relays will switch inductive loads of 0.5 to 1.0 power factor over temperature range. 0.6 to 1.0 for phase controlled models.
- ⑤ Off-state dv/dt test method per EIA/NARM standard RS-443, paragraph 13.11.1.
- ⑥ UL recognized (File E116949 and CSA certified (File #LR81689).
- ⑦ All models meet VDE requirements. (VDE0806/IEC380.) (File #58729)

## ELECTRICAL SPECIFICATIONS

### OUTPUT CHARACTERISTICS

MODEL	AC Control	A1202
NUMBERS	DC Control	01202
	Phase Controllable	—
Operating Voltage Range	47-63 Hz	Standard
	Phase Controllable -10 Models	
Max. Load Current (See derating curves) ①		2.5
Min. Load Current (-10: 25 watt lamp)		
Transient Overvoltage ②		
Max. Surge Current 16.6 ms (Non-Repetitive) (See surge curves)		22.5
Max. Over Current (Non-Repetitive) 1 sec.		5
Max. On-State Voltage Drop @ Rated Current		3.5
Max. 1 <sup>st</sup> T for Fusing (8.3 ms)		2.1
Thermal Resistance Junction-to-Case R <sub>JC</sub> (T <sub>J</sub> Max: = 115°C)		8.5
Power Dissipation @ Max. Current (See dissipation curves)		6.3
Max. Zero Voltage Turn-on	Zero Switching Only	
Max. Peak Repetitive Turn-on Voltage		
Max. Off-State Leakage Current @ Rated Voltage (-30°C ≤ T <sub>A</sub> ≤ 80°C)		
Min. Off-State dv/dt (static) @ Max. Rated Voltage ③		

### INPUT CHARACTERISTICS

Control Voltage Range	
Max. Reverse Voltage	
Max. Turn-On Voltage (-30°C ≤ T <sub>A</sub> ≤ 80°C)	
Min. Turn-Off Voltage (-30°C ≤ T <sub>A</sub> ≤ 80°C)	
Min. Input Impedance	
Max Input Current	
Max. Turn-On Time (@ 60 Hz)	
Max. Turn-Off Time (@ 60 Hz)	
Min. Input Pulse Width	
Minimum Pulse Termination Lead Time, T <sub>PT</sub>	See Figure 10
Minimum Pulse Initiation Lead Time, T <sub>PI</sub>	See Figure 10

### GENERAL CHARACTERISTICS

Dielectric Strength ①	⑤ 50/60 Hz Input/Output/Base
Insulation Resistance @ 500 VDC ①	
Max. Capacitance Input Output	
Ambient Temperature Range	Operating
	Storage

Data and specifications subject to change without notice.