

3515 AND 3516

RATIOMETRIC, LINEAR HALL-EFFECT SENSOR ICs FOR HIGH-TEMPERATURE OPERATION

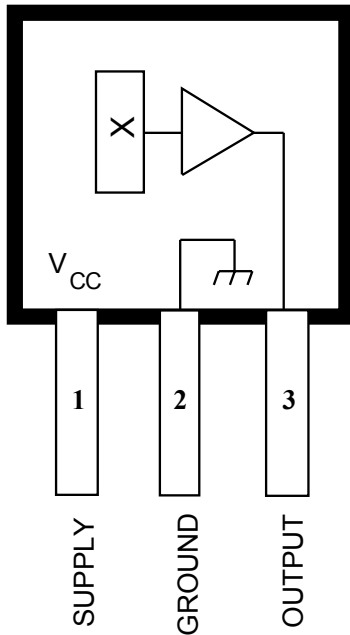

Dwg. PH-006

Pinning is shown viewed from branded side.

ABSOLUTE MAXIMUM RATINGS

Supply Voltage, V_{CC}	8.0 V
Output Voltage, V_O	8.0 V
Output Sink Current, I_O	10 mA
Magnetic Flux Density, B	Unlimited
Package Power Dissipation, P_D	See Graph
Operating Temperature Range*, T_A	
Suffix 'E-'	-40°C to +85°C
Suffix 'L-'	-40°C to +150°C
Storage Temperature Range, T_S	-65°C to +170°C

* Infrequent excursions permitted; see Applications Information.

The A3515- and A3516- are sensitive, temperature-stable linear Hall-effect sensor ICs with greatly improved offset characteristics. Ratiometric, linear Hall-effect devices provide a voltage output that is proportional to the applied magnetic field and have a quiescent output voltage that is approximately 50% of the supply voltage. These magnetic devices are ideal for use in linear and rotary position sensing systems in the harsh environments of automotive and industrial applications over extended temperatures to -40°C and +150°C. The A3515- features an output sensitivity of 5 mV/G, while the A3516- has an output sensitivity of 2.5 mV/G. See the Magnetic Characteristics table for complete, individual device parametrics.

Each BiCMOS monolithic circuit integrates a Hall element, improved temperature-compensating circuitry to reduce the intrinsic sensitivity drift of the Hall element, a small-signal high-gain amplifier, and a rail-to-rail low-impedance output stage.

A proprietary dynamic offset cancelation technique, with an internal high-frequency clock, reduces the residual offset voltage, which is normally caused by device overmolding, temperature dependancies, and thermal stress. This technique produces devices that have an extremely stable quiescent output voltage, are immune to mechanical stress, and have precise recoverability after temperature cycling. Many problems normally associated with low-level analog signals are minimized by having the Hall element and amplifier in a single chip. Output precision is obtained by internal gain and offset trim adjustments during the manufacturing process.

These devices are supplied in a 3-pin ultra-mini-SIP 'UA' package.

FEATURES

- Temperature-Stable Quiescent Output Voltage
- Precise Recoverability After Temperature Cycling
- Output Voltage Proportional to Applied Magnetic Field
- Ratiometric Rail-to-Rail Output
- Improved Sensitivity
- 4.5 V to 5.5 V Operation
- Immune to Mechanical Stress
- Small Package Size
- Solid-State Reliability

Always order by complete part number, e.g., **A3515LUA** .

3515 AND 3516 RATIOMETRIC, LINEAR HALL-EFFECT SENSOR ICs

FUNCTIONAL BLOCK DIAGRAM

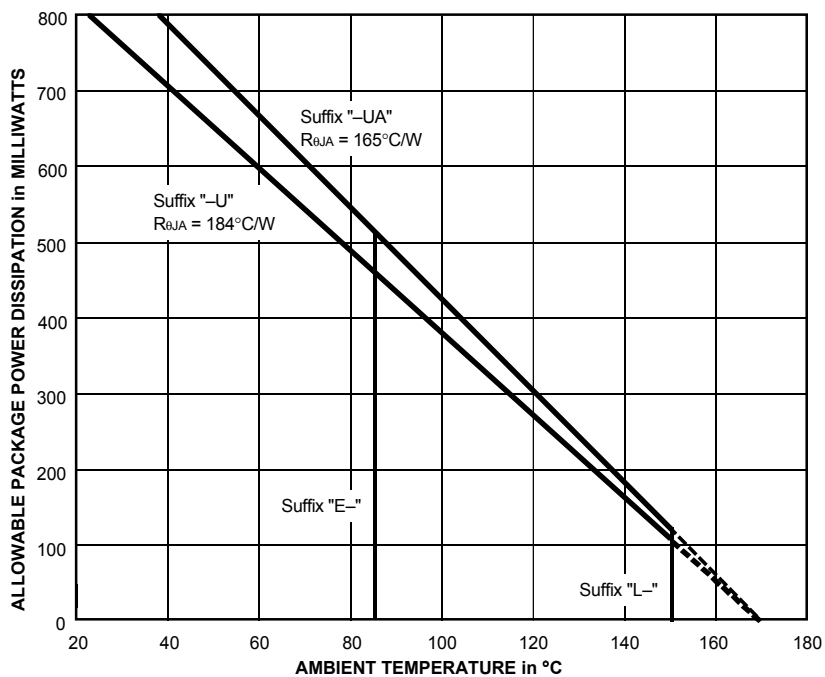
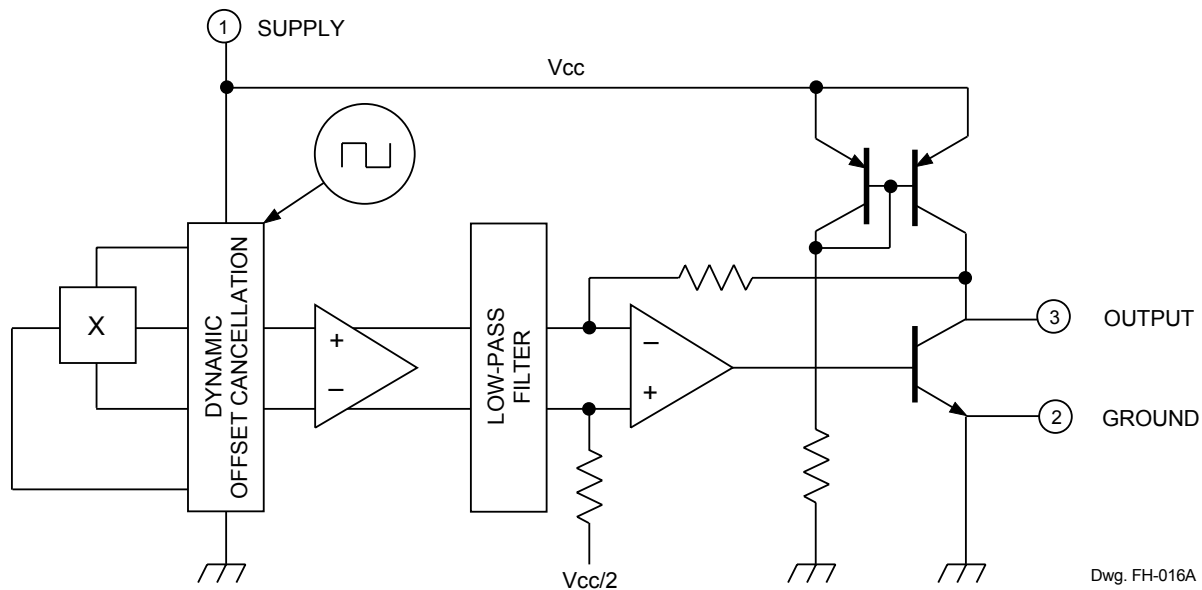

**3515 AND 3516
RATIOMETRIC,
LINEAR
HALL-EFFECT SENSOR ICs**

ELECTRICAL CHARACTERISTICS over operating temperature range, at $V_{CC} = 5\text{ V}$ (unless otherwise noted).

Characteristic	Symbol	Test Conditions	Limits			
			Min.	Typ.	Max.	Units
Supply Voltage	V_{CC}	Operating	4.5	5.0	5.5	V
Supply Current	I_{CC}	$B = 0, V_{CC} = 6\text{ V}, I_O = 0$	–	7.2	10	mA
Quiescent Voltage Output	V_{OQ}	$B = 0, I_O = 1\text{ mA}, T_A = 25^\circ\text{C}$	2.425	2.500	2.575	V
Output Voltage	V_{OH}	$B = +X^*, I_O = 1\text{ mA}$	–	4.7	–	V
	V_{OL}	$B = -X^*, I_O = -1\text{ mA}$	–	0.2	–	V
Output Source Current Limit	I_{OLM}	$B = -X^*, V_O = 0$	-1.0	-1.5	–	mA
Bandwidth (-3 dB)	BW		–	30	–	kHz
Clock Frequency	f_C		–	170	–	kHz
Output Resistance	r_O	$I_O \leq -2\text{ mA}$	–	1.0	–	Ω
Wide-Band Output Noise (rms)	e_o	$B = 0, BW = 10\text{ Hz to }10\text{ kHz}, I_O \leq -1\text{ mA}, C_O = 100\text{ pF}$	–	400	–	μV

NOTE 1 – Typical data is at $T_A = 25^\circ\text{C}$ and is for design information only.

NOTE 2 – Negative current is defined as coming out of (sourcing) the output.

* This test requires positive and negative fields sufficient to swing the output driver between fully OFF and saturated (ON), respectively. It is NOT intended to indicate a range of linear operation.

**3515 AND 3516
RATIOMETRIC,
LINEAR
HALL-EFFECT SENSOR ICS**

MAGNETIC CHARACTERISTICS over operating temperature range, at $V_{CC} = 5\text{ V}$, $I_O = -1\text{ mA}$ (unless otherwise noted).

Characteristic*	Part Numbers												Units
	A3515EUA			A3515LUA			A3516EUA			A3516LUA			
	Min.	Typ.	Max.	Min.	Typ.	Max.	Min.	Typ.	Max.	Min.	Typ.	Max.	
Operating Temp. Range, T_A	-40	-	+85	-40	-	+150	-40	-	+85	-40	-	+150	°C
Sensitivity at $T_A = 25^\circ\text{C}$	4.50	5.00	5.50	4.50	5.00	5.50	2.25	2.50	2.75	2.25	2.50	2.75	mV/G
$\Delta\text{Sens}_{(\Delta T)}$ at $T_A = \text{Max.}$	-2.5	2.5	7.5	-2.5	2.5	7.5	-2.5	2.5	7.5	-2.5	2.5	7.5	%
$\Delta\text{Sens}_{(\Delta T)}$ at $T_A = \text{Min.}$	-9.0	-1.3	1.0	-9.0	-1.3	1.0	-9.0	-1.3	1.0	-9.0	-1.3	1.0	%
$\Delta V_{OQ(\Delta T)}^\dagger$	-	-	± 10	-	-	± 10	-	-	± 10	-	-	± 10	G
Ratiometry, $\Delta V_{OQ(\Delta V)}$	-	100	-	-	100	-	-	100	-	-	100	-	%
Ratiometry, $\Delta\text{Sens}_{(\Delta V)}$	-	100	-	-	100	-	-	100	-	-	100	-	%
Positive Linearity, Lin+	-	100	-	-	100	-	-	100	-	-	100	-	%
Negative Linearity, Lin-	-	100	-	-	100	-	-	100	-	-	100	-	%
Symmetry	-	100	-	-	100	-	-	100	-	-	100	-	%

NOTE 1 – Magnetic flux density is measured at most sensitive area of device located 0.0195" (0.50 mm) below the branded face of the "UA" package.

NOTE 2 – 10 G = 1 mT, exactly.

NOTE 3 – Except for $\Delta\text{Sens}_{(\Delta T)}$, typical data is at $T_A = 25^\circ\text{C}$ and is for design information only.

* See Characteristics Definitions for test conditions.

† This calculation (formula 1, next page) yields the device's equivalent accuracy, over the operating temperature range, in gauss.

CHARACTERISTICS DEFINITIONS

Quiescent Voltage Output. In the quiescent state (no magnetic field), the output is ideally equal to one-half of the supply voltage over the operating voltage and temperature range ($V_{OQ} \cup V_{CC}/2$). Due to internal component tolerances and thermal considerations, there is a tolerance on the quiescent voltage output and on the quiescent voltage output as a function of supply voltage and ambient temperature. For purposes of specification, the quiescent voltage output as a function of temperature is defined as

$$\Delta V_{OQ(\Delta T)} = \frac{V_{OQ(TA)} - V_{OQ(25^{\circ}C)}}{Sens_{(25^{\circ}C)}} \quad (1)$$

This calculation yields the device's equivalent accuracy, over the operating temperature range, in gauss.

Sensitivity. The presence of a south-pole magnetic field perpendicular to the package face (the branded surface) will increase the output voltage from its quiescent value toward the supply voltage rail by an amount proportional to the magnetic field applied. Conversely, the application of a north pole will decrease the output voltage from its quiescent value. This proportionality is specified as the sensitivity of the device and is defined as

$$Sens = \frac{V_{O(500G)} - V_{O(-500G)}}{1000 \text{ G}} \quad (2)$$

The stability of sensitivity as a function of temperature is defined as

$$\Delta Sens_{(\Delta T)} = \frac{Sens_{(TA)} - Sens_{(25^{\circ}C)}}{Sens_{(25^{\circ}C)}} \times 100\% \quad (3)$$

Ratiometry. The A3515xUA and A3516xUA feature a ratiometric output. The quiescent voltage output and sensitivity are proportional to the supply voltage (ratiometric).

The per cent ratiometric change in the quiescent voltage output is defined as

$$\Delta V_{OQ(\Delta V)} = \frac{V_{OQ(VCC)} / V_{OQ(5V)}}{V_{CC} / 5 \text{ V}} \times 100\% \quad (4)$$

and the per cent ratiometric change in sensitivity is defined as

$$\Delta Sens_{(\Delta V)} = \frac{Sens_{(VCC)} / Sens_{(5V)}}{V_{CC} / 5 \text{ V}} \times 100\% \quad (5)$$

Linearity and Symmetry. The on-chip output stage is designed to provide a linear output to within 500 mV of either rail with a supply voltage of 5 V. This is equivalent to approximately ± 800 gauss of ambient field. Although application of stronger magnetic fields will not damage these devices, it will force the output into a non-linear region. Linearity in per cent is measured and defined as

$$Lin+ = \frac{V_{O(500G)} - V_{OQ}}{2 (V_{O(250G)} - V_{OQ})} \times 100\% \quad (6)$$

$$Lin- = \frac{V_{O(-500G)} - V_{OQ}}{2 (V_{O(-250G)} - V_{OQ})} \times 100\% \quad (7)$$

and output symmetry as

$$Sym = \frac{V_{O(500G)} - V_{OQ}}{V_{OQ} - V_{O(-500G)}} \times 100\% \quad (8)$$

3515 AND 3516 RATIOMETRIC, LINEAR HALL-EFFECT SENSOR ICs

TYPICAL CHARACTERISTICS

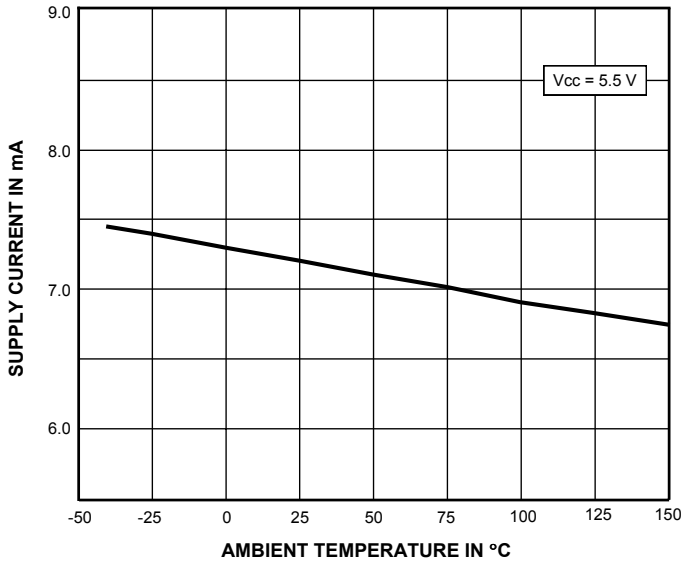

Dwg. GH-039-2

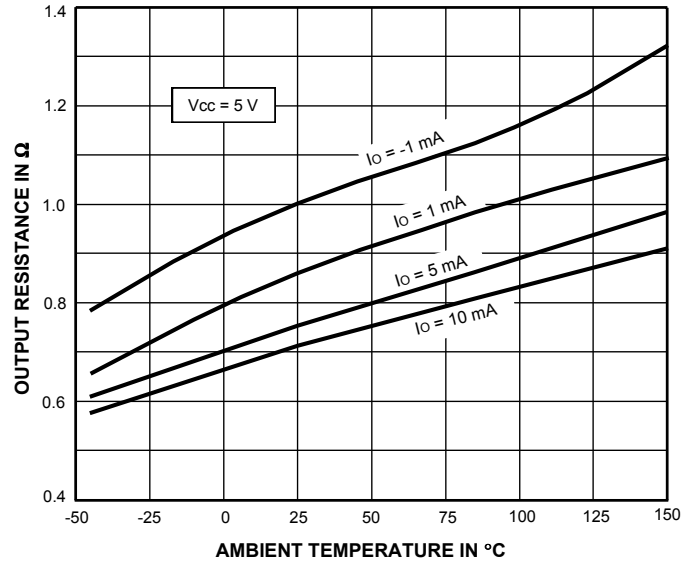

Dwg. GH-060-1

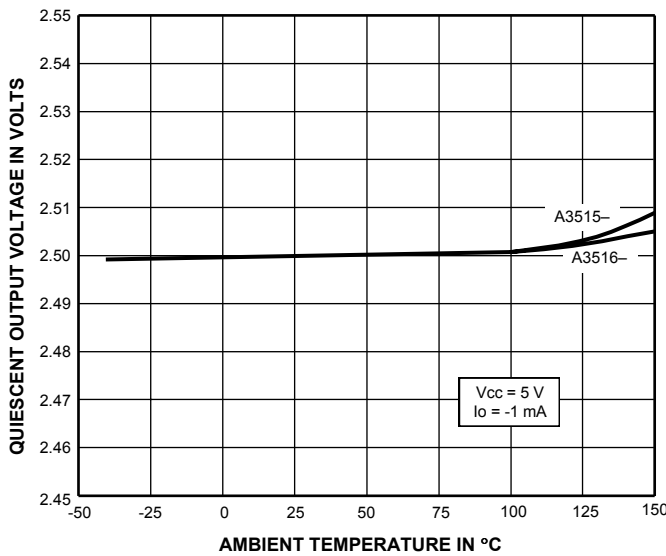

Dwg. GH-067

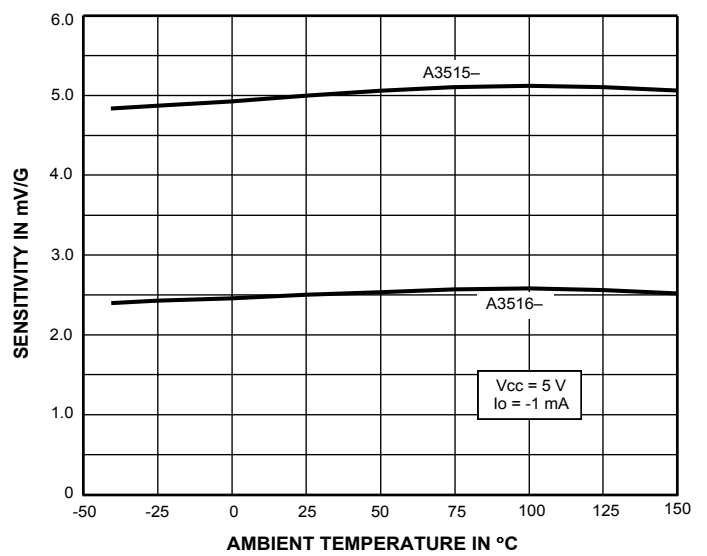

Dwg. GH-066

3515 AND 3516 RATIOMETRIC, LINEAR HALL-EFFECT SENSOR ICS

APPLICATIONS INFORMATION

Calibrated linear Hall devices, which can be used to determine the actual flux density presented to the device in a particular application, are available.

For safe, reliable operation, the output should not be pulled above the supply voltage or pulled below the device ground.

For optimum performance, a 0.1 μ F capacitor between the supply and ground, and a 100 pF capacitor between the output and ground, should be added.

The ratiometric feature is especially valuable when these devices are used with an analog-to-digital converter. A/D converters typically derive their LSB step size by ratioing off a reference voltage line. If the reference voltage varies, the LSB will vary proportionally. This is a major error source in many sensing systems. The A3515xUA and A3516xUA can eliminate this source of error by their ratiometric operation. Because their gain and offsets are proportional to the supply voltage, if they are powered from the A/D reference voltage, the device output voltage will track changes in the LSB value.

These devices can withstand infrequent temperature excursions, beyond the Absolute Maximum Ratings, to $T_A = 170^\circ\text{C}$ provided the junction temperature, T_J , does not exceed 200°C .

Extensive applications information on Hall-effect devices and magnets is also available in the "Hall-Effect IC Applications Guide", which can be found in the latest issue of the *Allegro MicroSystems Electronic Data Book*, AMS-702 or *Application Note 27701*, or at

www.allegromicro.com

TYPICAL CURRENT-SENSING APPLICATION

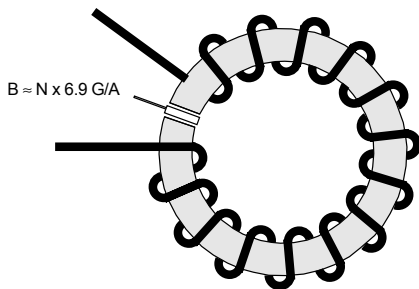

ELEMENT LOCATION

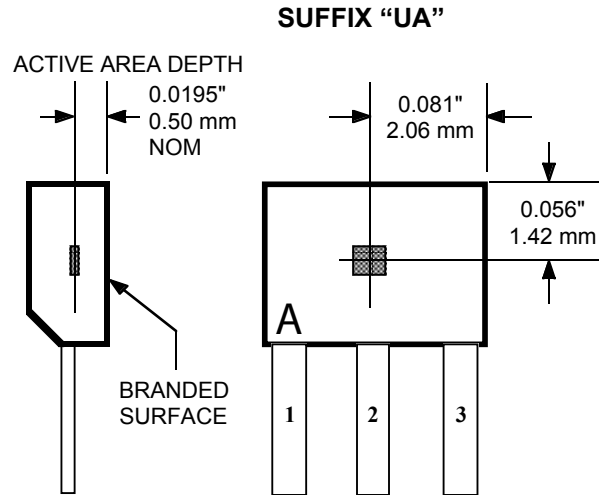

3515 AND 3516 RATIOMETRIC, LINEAR HALL-EFFECT SENSOR ICs

TYPICAL POSITION-SENSING APPLICATIONS (Alnico 8, dimensions in inches)

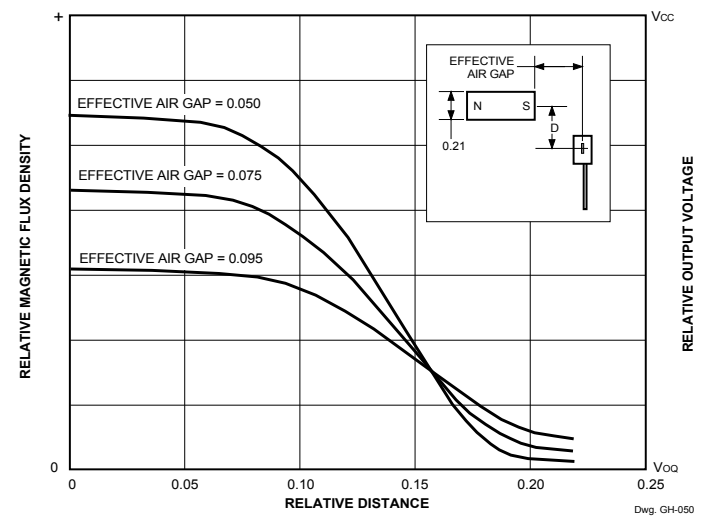
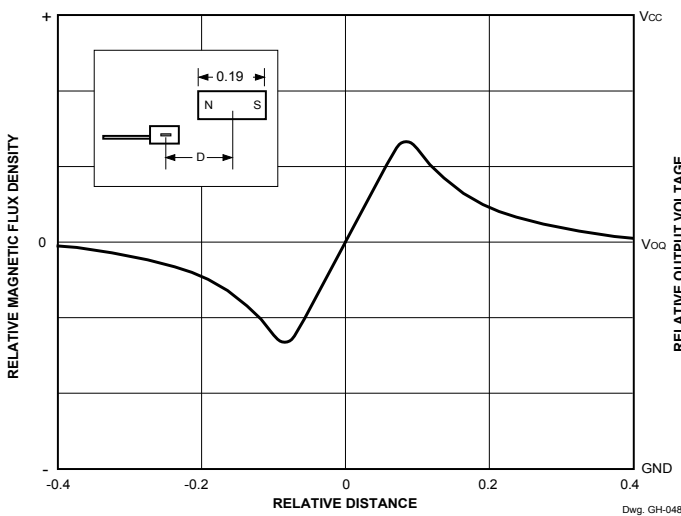
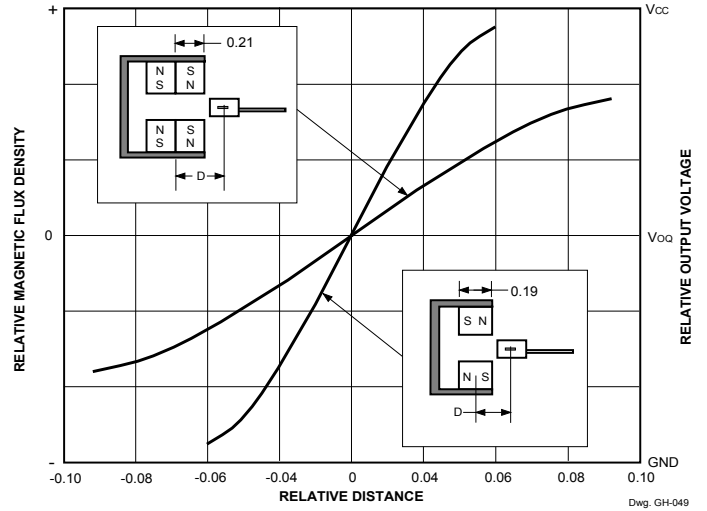
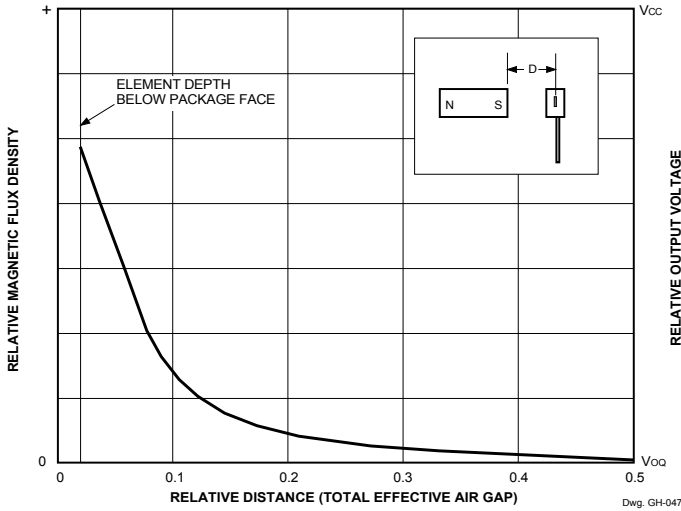

3515 AND 3516 RATIOMETRIC, LINEAR HALL-EFFECT SENSOR ICS

A3515xUA and A3516xUA

Dimensions in Inches
(controlling dimensions)

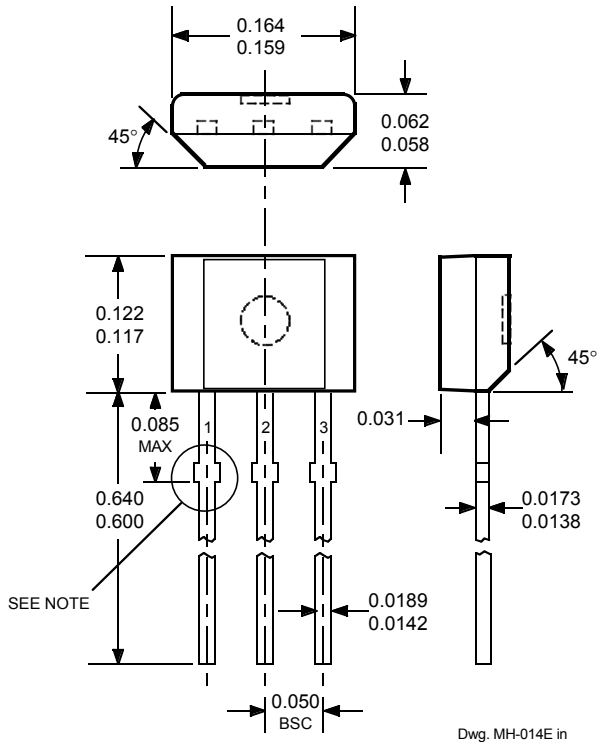

Dimensions in Millimeters
(for reference only)

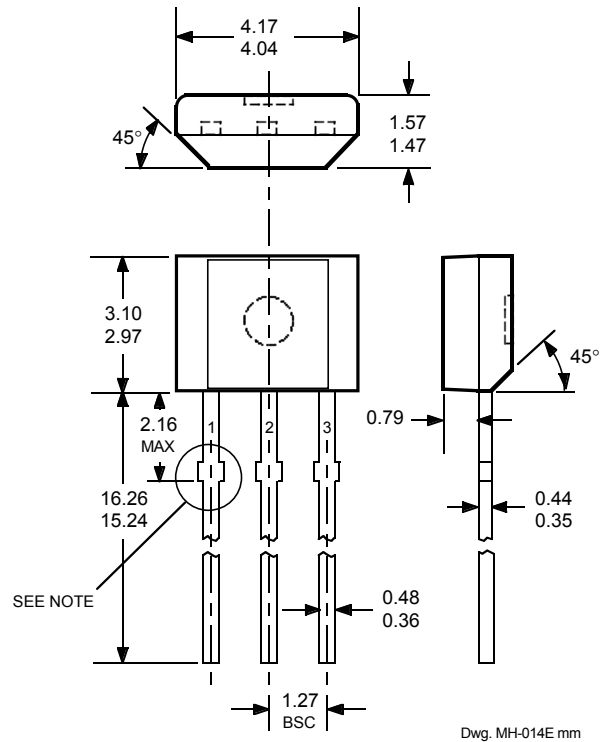

- NOTES:
1. Tolerances on package height and width represent allowable mold offsets. Dimensions given are measured at the widest point (parting line).
 2. Exact body and lead configuration at vendor's option within limits shown.
 3. Height does not include mold gate flash.
 4. Recommended minimum PWB hole diameter to clear transition area is 0.035" (0.89 mm).
 5. Where no tolerance is specified, dimension is nominal.
 6. Supplied in bulk pack (500 pieces per bag).

Radial Lead Form (order A351xxUA-LC)

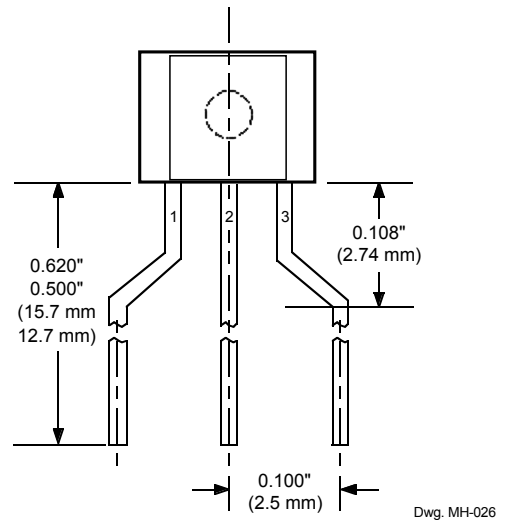

NOTE: Lead-form dimensions are the nominals produced on the forming equipment. No dimensional tolerance is implied or guaranteed for bulk packaging (500 pieces per bag).

3515 AND 3516 RATIOMETRIC, LINEAR HALL-EFFECT SENSOR ICs

Horizontal-Mount Lead Form (order A351xxUA-TL)

Dimensions in Inches (controlling dimensions)

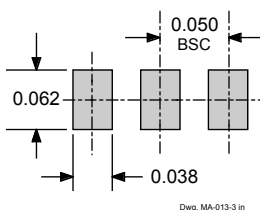
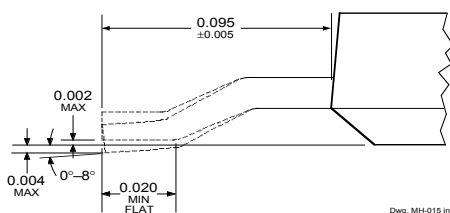

Dimensions in Millimeters (for reference only)

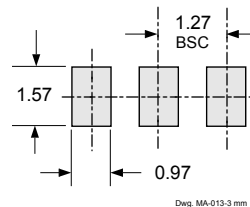
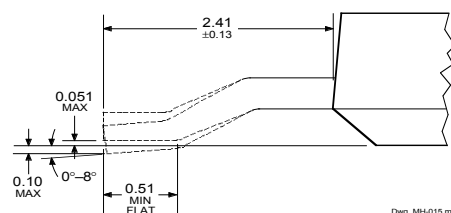

NOTE: Supplied in bulk pack (500 devices per bag).

The products described herein are manufactured under one or more of the following U.S. patents: 5,045,920; 5,264,783; 5,442,283; 5,389,889; 5,581,179; 5,517,112; 5,619,137; 5,621,319; 5,650,719; 5,686,894; 5,694,038; 5,729,130; 5,917,320; and other patents pending.

Allegro MicroSystems, Inc. reserves the right to make, from time to time, such departures from the detail specifications as may be required to permit improvements in the performance, reliability, or manufacturability of its products. Before placing an order, the user is cautioned to verify that the information being relied upon is current.

Allegro products are not authorized for use as critical components in life-support appliances, devices, or systems without express written approval.

The information included herein is believed to be accurate and reliable. However, Allegro MicroSystems, Inc. assumes no responsibility for its use; nor for any infringements of patents or other rights of third parties that may result from its use.