

RoHS SIDACtor® Balanced Multiport Series - MS-013



Description

SIDACtor® Balanced Multiport Series MS-013 are designed to protect baseband equipment from overvoltage transients. The patented “Y” configuration ensures balanced overvoltage protection.

The series provides a dual port surface mount solution that enables voice through DS-1 equipment to comply with various global regulatory standards.

Features and Benefits

- Low voltage overshoot
- Low on-state voltage
- Does not degrade with use
- Fails short circuit when surged in excess of ratings
- Low Capacitance
- Replaces six discrete devices
- Balanced overvoltage protection
- Meets UL/IEC 60950-1 creepage and clearance
- Two-port protection

Agency Approvals

| Agency | Agency File Number |
|--------|--------------------|
| | E133083 |

Pinout Designation

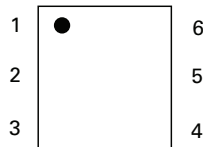

Schematic Diagram

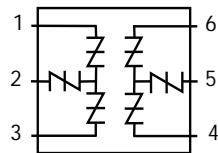

Applicable Global Standards

- TIA-968-A
- TIA-968-B
- ITU K.20/21 Enhanced Level*
- ITU K.20/21 Basic Level
- GR 1089 Inter-building*
- GR 1089 Intra-building
- IEC 61000-4-5
- YD/T 1082
- YD/T 993
- YD/T 950

*A/B-rated parts require series resistance

Electrical Characteristics

| Part Number | Marking | V_{DRM} | V_S | V_{DRM} | V_S | V_T | I_H | I_S | I_T | Capacitance |
|-------------|----------|----------------------|-----------------|----------------------|-----------------|-----------------|-------|-------|-------|------------------------------|
| | | @ $I_{DRM} = 5\mu A$ | @ 100V/ μs | @ $I_{DRM} = 5\mu A$ | @ 100V/ μs | @ $I_T = 2.2 A$ | mA | mA | A | |
| | | V min | V max | V min | V max | V max | min | max | max | |
| A2106UA6Lxx | A2106UA6 | 170 | 250 | 50 | 80 | 8 | 120 | 800 | 2.2 | See Capacitance Values Table |
| A5030UA6Lxx | A5030UA6 | 400 | 550 | 270 | 340 | 8 | 150 | 800 | 2.2 | |
| A2106UB6Lxx | A2106UB6 | 170 | 250 | 50 | 80 | 8 | 120 | 800 | 2.2 | |
| A5030UB6Lxx | A5030UB6 | 400 | 550 | 270 | 340 | 8 | 150 | 800 | 2.2 | |
| A2106UC6Lxx | A2106UC6 | 170 | 250 | 50 | 80 | 8 | 120 | 800 | 2.2 | |
| A5030UC6Lxx | A5030UC6 | 400 | 550 | 270 | 340 | 8 | 150 | 800 | 2.2 | |
| P1556UALxx | P1556UA | 130 | 180 | 130 | 180 | 8 | 150 | 800 | 2.2 | |
| P1806UALxx | P1806UA | 150 | 210 | 150 | 210 | 8 | 150 | 800 | 2.2 | |
| P2106UALxx | P2106UA | 170 | 250 | 170 | 250 | 8 | 150 | 800 | 2.2 | |
| P2356UALxx | P2356UA | 200 | 270 | 200 | 270 | 8 | 150 | 800 | 2.2 | |
| P2706UALxx | P2706UA | 230 | 300 | 230 | 300 | 8 | 150 | 800 | 2.2 | |
| P3206UALxx | P3206UA | 270 | 350 | 270 | 350 | 8 | 150 | 800 | 2.2 | |
| P3406UALxx | P3406UA | 300 | 400 | 300 | 400 | 8 | 150 | 800 | 2.2 | |

Table continues on next page.

Electrical Characteristics (continued)

| Part Number | Marking | V_{DRM} | V_S | V_{DRM} | V_S | V_T | I_H | I_S | I_T | Capacitance |
|-------------|---------|-------------------------|-----------------|----------------------|-----------------|-------------------------|--------|--------|-------|------------------------------------|
| | | @ $I_{DRM} = 5\mu A$ | @ 100V/ μs | @ $I_{DRM} = 5\mu A$ | @ 100V/ μs | @ $I_T = 2.2 A$ | | | | |
| | | V min | V max | V min | V max | V max | mA min | mA max | A max | |
| | | Pins 1-2, 3-2, 4-5, 6-5 | | Pins 1-3, 4-6 | | Pins 1-2, 3-2, 4-5, 6-5 | | | | |
| P5106UALxx | P5106UA | 420 | 600 | 420 | 600 | 8 | 150 | 800 | 2.2 | See Capacitance Values Table |
| P1556UBLxx | P1556UB | 130 | 180 | 130 | 180 | 8 | 150 | 800 | 2.2 | |
| P1806UBLxx | P1806UB | 150 | 210 | 150 | 210 | 8 | 150 | 800 | 2.2 | |
| P2106UBLxx | P2106UB | 170 | 250 | 170 | 250 | 8 | 150 | 800 | 2.2 | |
| P2356UBLxx | P2356UB | 200 | 270 | 200 | 270 | 8 | 150 | 800 | 2.2 | |
| P2706UBLxx | P2706UB | 230 | 300 | 230 | 300 | 8 | 150 | 800 | 2.2 | |
| P3206UBLxx | P3206UB | 270 | 350 | 270 | 350 | 8 | 150 | 800 | 2.2 | |
| P3406UBLxx | P3406UB | 300 | 400 | 300 | 400 | 8 | 150 | 800 | 2.2 | |
| P5106UBLxx | P5106UB | 420 | 600 | 420 | 600 | 8 | 150 | 800 | 2.2 | |
| P1556UCLxx | P1556UC | 130 | 180 | 130 | 180 | 8 | 150 | 800 | 2.2 | |
| P1806UCLxx | P1806UC | 150 | 210 | 150 | 210 | 8 | 150 | 800 | 2.2 | |
| P2106UCLxx | P2106UC | 170 | 250 | 170 | 250 | 8 | 150 | 800 | 2.2 | |
| P2356UCLxx | P2356UC | 200 | 270 | 200 | 270 | 8 | 150 | 800 | 2.2 | |
| P2706UCLxx | P2706UC | 230 | 300 | 230 | 300 | 8 | 150 | 800 | 2.2 | |
| P3206UCLxx | P3206UC | 270 | 350 | 270 | 350 | 8 | 150 | 800 | 2.2 | |
| P3406UCLxx | P3406UC | 300 | 400 | 300 | 400 | 8 | 150 | 800 | 2.2 | |
| P5106UCLxx | P5106UC | 420 | 600 | 420 | 600 | 8 | 150 | 800 | 2.2 | |

Notes:
 - Absolute maximum ratings measured at $T_A = 25^\circ C$ (unless otherwise noted).
 - Devices are bi-directional (some are asymmetrical).
 - XX = Part Number Suffix: 'TP' (Tube Pack) or 'RP' (Reel Pack).

Surge Ratings

| Series | I_{PP} | | | | | | | | | I_{TSM} 50/60 Hz | di/dt |
|--------|--|--|--|--|--|--|--|--|---|-----------------------|-------|
| | 0.2x310 ¹ 0.5x700 ² | 2x10 ¹ 2x10 ² | 8x20 ¹ 1.2x50 ² | 10x160 ¹ 10x160 ² | 10x560 ¹ 10x560 ² | 5x320 ¹ 9x720 ² | 10x360 ¹ 10x360 ² | 10x1000 ¹ 10x1000 ² | 5x310 ¹ 10x700 ² | | |
| | A min | A min | A min | A min | A min | A min | A min | A min | A min | | |
| A | 20 | 150 | 150 | 90 | 50 | 75 | 75 | 45 | 75 | 20 | 500 |
| B | 25 | 250 | 250 | 150 | 100 | 100 | 125 | 80 | 100 | 25 | 500 |
| C | 50 | 500 | 400 | 200 | 150 | 200 | 175 | 100 | 200 | 30 | 500 |

Notes:
 1 Current waveform in μs
 2 Voltage waveform in μs
 - Peak pulse current rating (I_{pp}) is repetitive and guaranteed for the life of the product.
 - I_{pp} ratings applicable over temperature range of -40 to $+85^\circ C$
 - The device must initially be in thermal equilibrium with $-40^\circ C \leq T_J \leq +150^\circ C$

Thermal Considerations

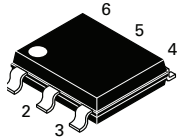
| Package | Symbol | Parameter | Value | Unit |
|--|-----------------|---|-------------|--------------|
| Modified MS-013  | T_J | Operating Junction Temperature Range | -40 to +150 | $^\circ C$ |
| | T_S | Storage Temperature Range | -65 to +150 | $^\circ C$ |
| | $R_{\theta JA}$ | Thermal Resistance: Junction to Ambient | 60 | $^\circ C/W$ |

Capacitance Values

| Part Number | pF Pin 1-2 / 3-2 (4-5 / 6-5) Tip-Ground, Ring-Ground | | pF Pin 1-3 (4-6) Tip-Ring | |
|-------------|--|-----|---------------------------------|-----|
| | MIN | MAX | MIN | MAX |
| | A2106UA6Lxx | 20 | 60 | 10 |
| A5030UA6Lxx | 15 | 35 | 10 | 45 |
| A2106UB6Lxx | 20 | 60 | 10 | 30 |
| A5030UB6Lxx | 15 | 35 | 10 | 45 |
| A2106UC6Lxx | 20 | 70 | 10 | 45 |
| A5030UC6Lxx | 25 | 40 | 20 | 35 |
| P1556UALxx | 20 | 45 | 10 | 30 |
| P1806UALxx | 20 | 40 | 10 | 30 |
| P2106UALxx | 15 | 35 | 10 | 25 |
| P2356UALxx | 15 | 35 | 10 | 25 |
| P2706UALxx | 15 | 35 | 10 | 25 |
| P3206UALxx | 15 | 30 | 10 | 20 |
| P3406UALxx | 15 | 30 | 10 | 20 |
| P5106UALxx | 10 | 20 | 5 | 15 |
| P1556UBLxx | 20 | 45 | 10 | 30 |
| P1806UBLxx | 20 | 40 | 10 | 30 |
| P2106UBLxx | 15 | 35 | 10 | 25 |
| P2356UBLxx | 15 | 35 | 10 | 25 |
| P2706UBLxx | 15 | 35 | 10 | 25 |
| P3206UBLxx | 15 | 30 | 10 | 20 |
| P3406UBLxx | 15 | 30 | 10 | 20 |
| P5106UBLxx | 10 | 20 | 5 | 15 |
| P1556UCLxx | 30 | 55 | 20 | 35 |
| P1806UCLxx | 30 | 50 | 15 | 35 |
| P2106UCLxx | 30 | 45 | 15 | 30 |
| P2356UCLxx | 25 | 40 | 15 | 30 |
| P2706UCLxx | 25 | 40 | 15 | 30 |
| P3206UCLxx | 20 | 35 | 15 | 25 |
| P3406UCLxx | 20 | 35 | 15 | 25 |
| P5106UCLxx | 20 | 30 | 10 | 20 |

Note: Off-state capacitance (C_o) is measured at 1 MHz with a 2 V bias.

Physical Specifications

| | |
|------------------------|---|
| Lead Material | Copper Alloy |
| Terminal Finish | 100% Matte-Tin Plated |
| Body Material | UL recognized epoxy meeting flammability classification 94V-0 |

Soldering Parameters

| | | |
|--|------------------------------------|--------------|
| Reflow Condition | Pb-Free assembly (see Fig. 1) | |
| Pre Heat | - Temperature Min ($T_{s(min)}$) | +150°C |
| | - Temperature Max ($T_{s(max)}$) | +200°C |
| | - Time (Min to Max) (t_s) | 60-180 secs. |
| Average ramp up rate (Liquidus Temp (T_L) to peak) | 3°C/sec. Max. | |
| $T_{s(max)}$ to T_L - Ramp-up Rate | 3°C/sec. Max. | |
| Reflow | - Temperature (T_L) (Liquidus) | +217°C |
| | - Temperature (t_L) | 60-150 secs. |
| Peak Temp (T_p) | +260(+0/-5)°C | |
| Time within 5°C of actual PeakTemp (t_p) | 30 secs. Max. | |
| Ramp-down Rate | 6°C/sec. Max. | |
| Time 25°C to PeakTemp (T_p) | 8 min. Max. | |
| Do not exceed | +260°C | |

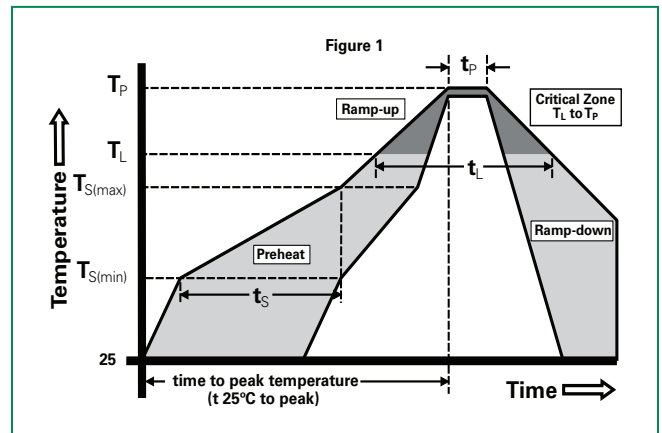

Environmental Specifications

| | |
|---|--|
| High Temp Voltage Blocking | 80% Rated V_{DRM} ($V_{AC Peak}$) +125°C or +150°C, 504 or 1008 hrs. MIL-STD-750 (Method 1040) JEDEC, JESD22-A-101 |
| Temp Cycling | -65°C to +150°C, 15 min. dwell, 10 up to 100 cycles. MIL-STD-750 (Method 1051) EIA/JEDEC, JESD22-A-104 |
| Biased Temp & Humidity | 52 V_{DC} (+85°C) 85% RH, 504 up to 1008 hrs. EIA/JEDEC, JESD22-A-101 |
| High Temp Storage | +150°C 1008 hrs. MIL-STD-750 (Method 1031) JEDEC, JESD22-A-101 |
| Low Temp Storage | -65°C, 1008 hrs. |
| Thermal Shock | 0°C to +100°C, 5 min. dwell, 10 sec. transfer, 10 cycles. MIL-STD-750 (Method 1056) JEDEC, JESD22-A-106 |
| Autoclave (Pressure Cooker Test) | +121°C, 100%RH, 2atm, 24 up to 168 hrs. EIA/JEDEC, JESD22-A-102 |
| Resistance to Solder Heat | +260°C, 30 secs. MIL-STD-750 (Method 2031) |
| Moisture Sensitivity Level | 85% RH, +85°C, 168 hrs., 3 reflow cycles (+260°C Peak). JEDEC-J-STD-020, Level 1 |

V-I Characteristics

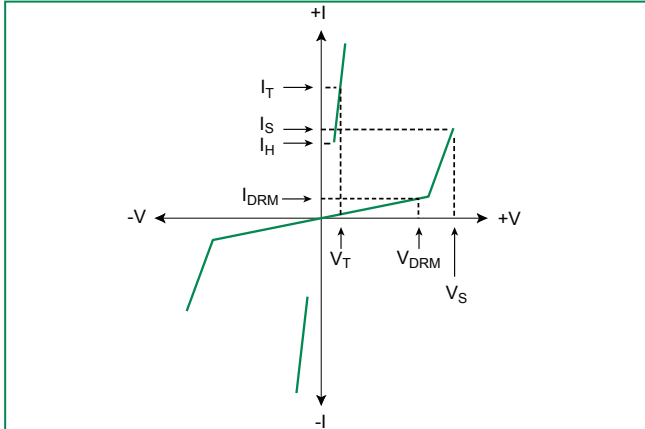

$t_r \times t_d$ Pulse Waveform

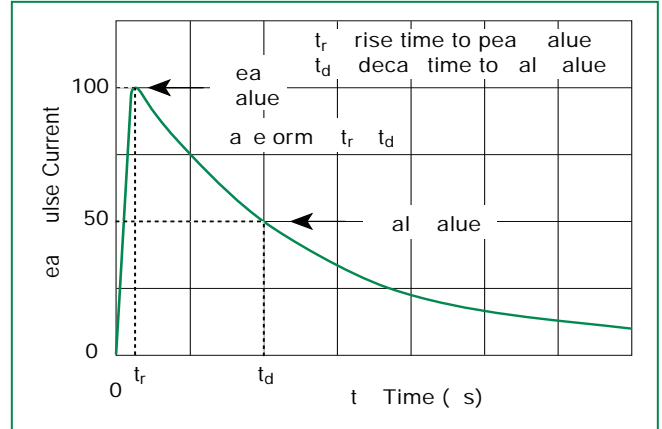

Normalized V_S Change vs. Junction Temperature

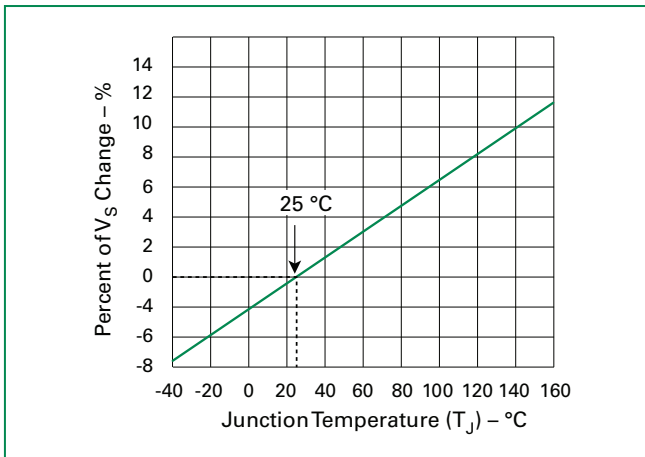

Normalized DC Holding Current vs. Case Temperature

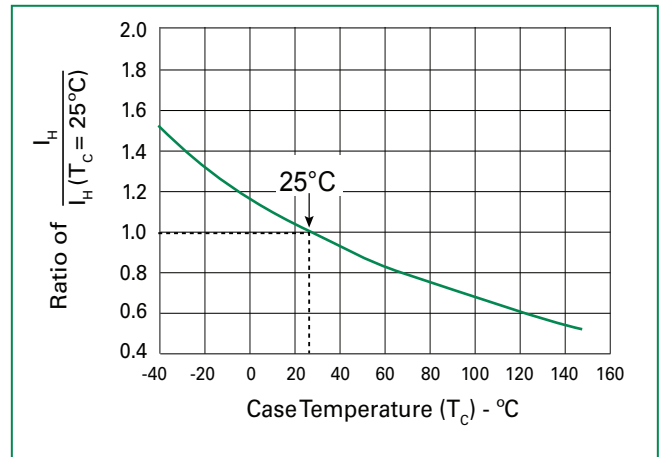

Part Numbering

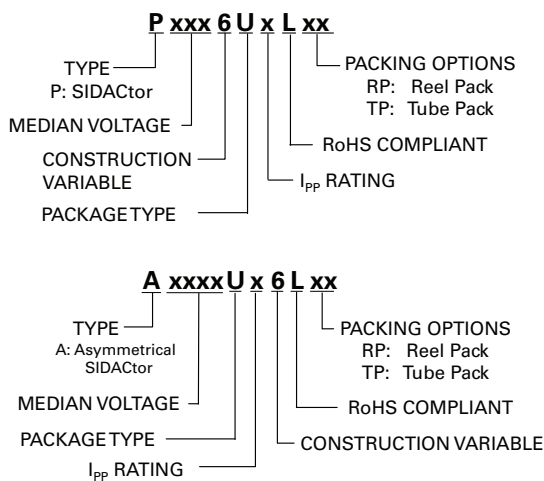

Part Marking

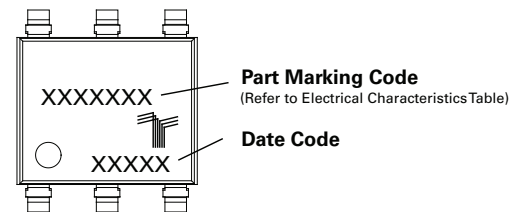

Dimensions — MS-013

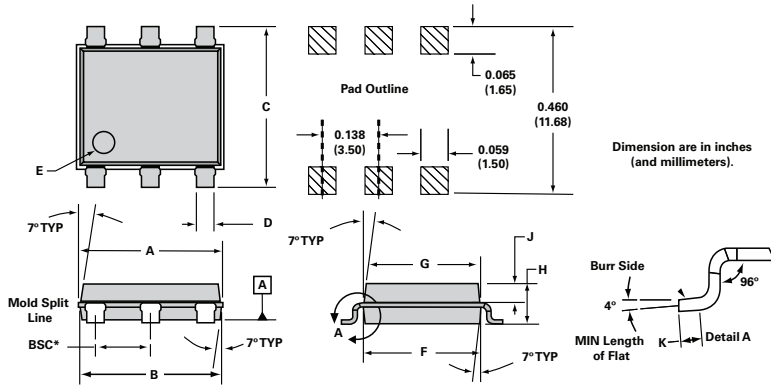

| Dimensions | Inches | | Millimeters | |
|-------------|--------|-------|-------------|-------|
| | Min | Max | Min | Max |
| A | 0.360 | 0.364 | 9.14 | 9.25 |
| B | 0.352 | 0.356 | 8.94 | 9.04 |
| C | 0.400 | 0.412 | 10.16 | 10.46 |
| D | 0.043 | 0.045 | 1.09 | 1.13 |
| E | 0.047 | 0.055 | 1.19 | 1.40 |
| F | 0.293 | 0.297 | 7.44 | 7.54 |
| G | 0.289 | 0.293 | 7.34 | 7.44 |
| H | 0.089 | 0.093 | 2.26 | 2.36 |
| J | 0.041 | 0.049 | 1.04 | 1.24 |
| K | 0.020 | | 0.51 | |
| BSC* | 0.133 | 0.143 | 3.38 | 3.63 |

* BSC = Basic Spacing between Centers

Packing Options

| Package Type | Description | Quantity | Added Suffix | Industry Standard |
|--------------|--|----------------------|--------------|-------------------|
| U | Modified MS-013 6-pin Tape and Reel Pack | 1500 | RP | EIA-481-D |
| | Modified MS-013 6-pin Tube Pack | 500 (50 per tube) | TP | N/A |

Tape and Reel Specification — MS-013

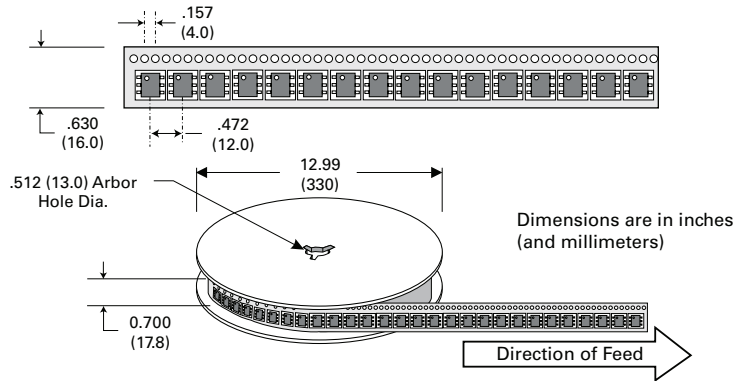

Tube Pack Specification — MS-013

