



Document Title

Data sheet of A7533.

Revision History

<u>Rev. No.</u>	<u>History</u>	<u>Issue Date</u>	<u>Remark</u>
0.1	Initial issue.	Jun. 25 th , 2007	Preliminary
0.2	Logo changed.	Oct. 18 th , 2007	
0.3	Change DC spec, truth table	Dec. 7 th , 2007	
0.4	Add B type	Jan. 16 th , 2008	
0.5	Modify ordering information, add top marking info., reflow profile	Apr. 17 th , 2008	
0.6	Change pin definition	Jul, 15, 2008	
0.7	Modify typo of Pin 14 and Pin 16, add remark of application ckt.	Jul, 08, 2009	
0.8	Modify pin configuration 4,5,8 typo	Feb, 22, 2010	

AMICCOM CONFIDENTIAL

Important Notice:

AMICCOM reserves the right to make changes to its products or to discontinue any integrated circuit product or service without notice. AMICCOM integrated circuit products are not designed, intended, authorized, or warranted to be suitable for use in life-support applications, devices or systems or other critical applications. Use of AMICCOM products in such applications is understood to be fully at the risk of the customer.

Table of Contents

1 Typical Applications	1
2 General Description.....	1
3 Pin Assignments.....	1
4 Block Diagram.....	2
5 Pin Configurations.....	3
6 Electrical Specifications	4
7 Absolute Maximum Ratings.....	4
8 Applications Circuit	5
9 Truth Table	6
10 Ordering Information.....	8
11 Package Information.....	9
12 Top Marking Information	10
13 Reflow Profile.....	12
14 Tape Reel Information.....	13
15 Product Status.....	16

AMICCOM CONFIDENTIAL

<Preliminary>

4X2 Switch Matrix with Tone/Polarity Controller

1 Typical Applications

4*2 Switch Matrix for 0.2 -3.0 GHz Applications:

- LNB
- CATV
- Cellular Systems
- DBS

2 General Description

A7533 is a low-cost 4 x 2 switch matrix with tone detector in a 20-lead QFN package for use in RF multiplexing applications from 200 to 3000 MHz. A positive voltage controlled 4 bit decoder and tone/polarity detector are both integrated on the switch with DiSEqC control signals rejection. A7533 is ok to be used in 50/75 ohm systems.

Switch outputs (OP1 & OP2) can be independently selected from any of the four inputs (HH, HL, VH, VL) or simultaneously select the same inputs. Note that the switch is bi-directional and input/output functionality may be interchanged.

3 Pin Assignments

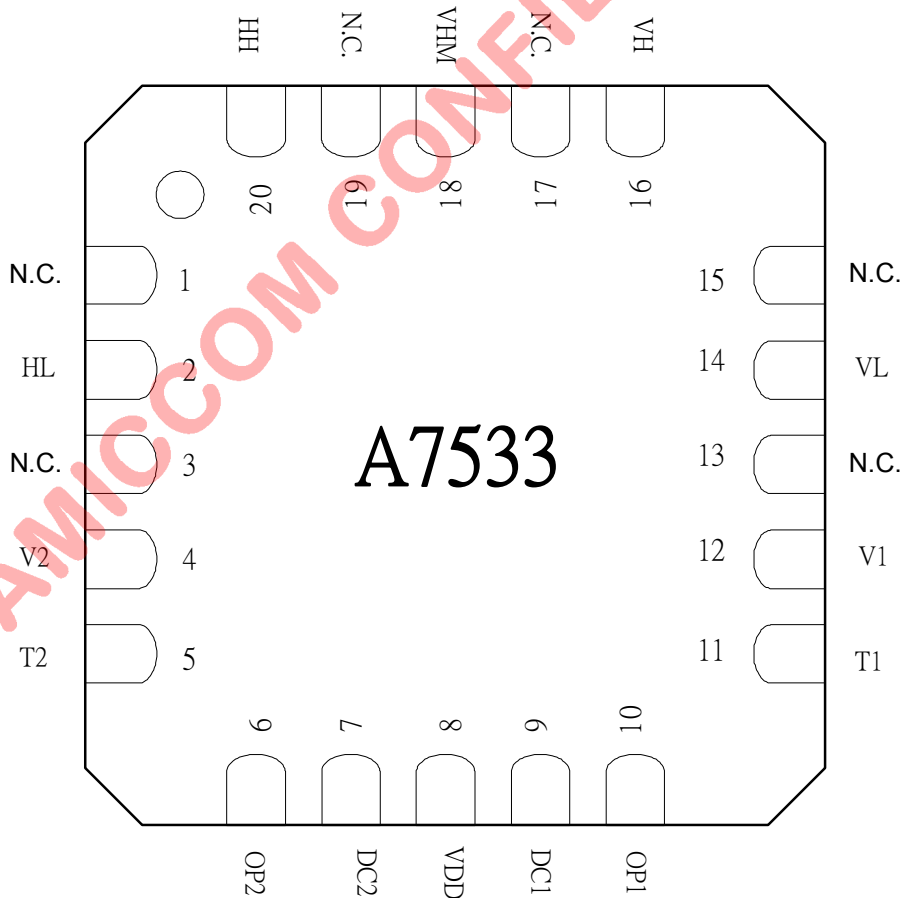

A7533 QFN Package Top View

4 Block Diagram

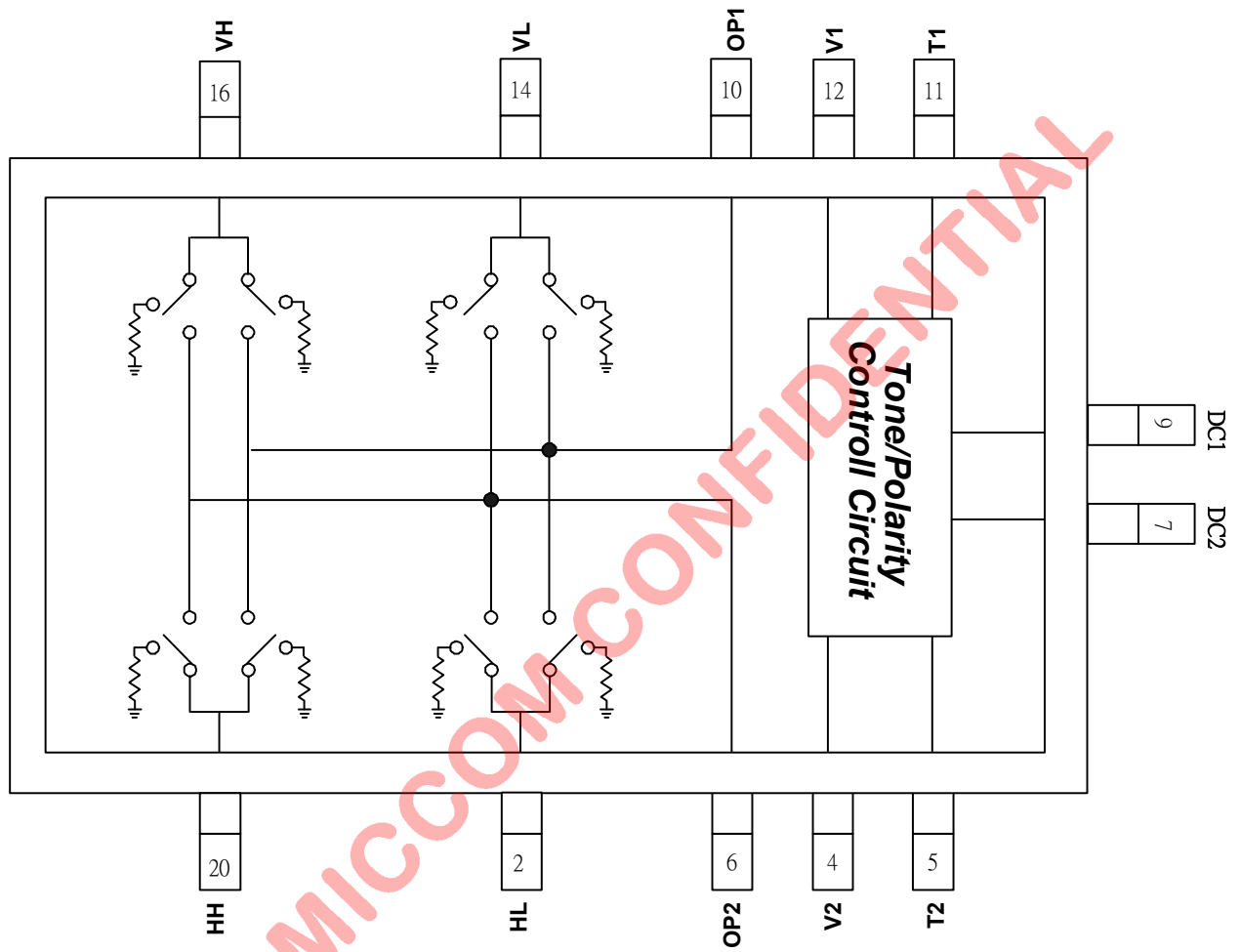

5 Pin Configurations

Pin No.	Pin Name	Function
11 12	T1 V1	Tone and Polarity detector input.
4 5	V2 T2	Tone and Polarity detector input.
14 16 20 2	VL VH HH HL	RF input pin
10 6	OP1 OP2	RF output pin
8	VDD	Power pin, Connect to power.
1 3 13 15 17 19	N.C.	No connection, Connect to PCB ground.
18	VHM	Vertical-Horizontal Mirror. Connect to ground → Normal Leave open → Mirror.
7 9	DC2 DC1	By-pass , Connect to by-pass capacitor
Back side paddle	GND	Connect to ground.

6 Electrical Specifications

Typical condition: $T_A = +25^\circ\text{C}$, $V_{DD} = +3.3\text{V}$, 50 ohm System. All RF port are terminated to 50 ohm .

Parameter	Condition	Min.	Typ.	Max.	Units
Switch					
Insertion Loss	200 - 950 MHz	6	6.5	8.5	dB
	950 - 1450 MHz	6	6.5	7.5	
	1450 - 2150 MHz	6.5	7.5	8	
	2150 - 3000 MHz	7	9	11	
Isolation	200 - 950 MHz	35	37		dB
	950 - 1450 MHz	31	33		
	1450 - 2150 MHz	29	31		
	2150 - 3000 MHz	23	25		
Return Loss (Input; VL, HL, VH, HH)	200 - 3000 MHz	12	15		dB
Return Loss (Output; OP1, OP2)	200 - 3000 MHz	10	15		dB
Output IP3	200 - 3000 MHz	20			dBm
Input Power for 1 dB Compression	200 - 3000 MHz	15			dBm
Switching On/Off Speed $t_{\text{RISE}} / t_{\text{FALL}} (10/90\% \text{ RF})$	200 - 3000 MHz			10	ms
Polarity and Tone Detector					
Polarity Threshold	With external $62\text{K}\Omega$	14	14.75	15.5	V
Tone Signal Frequency	$-40\sim 85^\circ\text{C}$, 650mVpp	7	22	78	KHz
Tone Signal Duty Cycle	$-40\sim 85^\circ\text{C}$	40	50	60	%
Tone Signal Amplitude Threshold	With external $62\text{K}\Omega$ and 500pF	0.1	0.17		Vpp
Power supply					
Supply Voltage	$-40\sim 85^\circ\text{C}$	3	3.3	4.2	V
Current Consumption	$-40\sim 85^\circ\text{C}$	1.5	2.2	3.2	mA

Note: Tone/Polarization threshold could be tuned by change the value of external R,C. Please contact AMICCOM FAE for specified application.

7 Absolute Maximum Ratings

Parameter	Rating
Bias Voltage Range (VDD)	+5 VDC
Storage Temperature	-65 to $+150^\circ\text{C}$
Operating Temperature	-40 to $+85^\circ\text{C}$
Maximum Input Power	+17 dBm (200 - 3000 MHz)

8 Applications Circuit

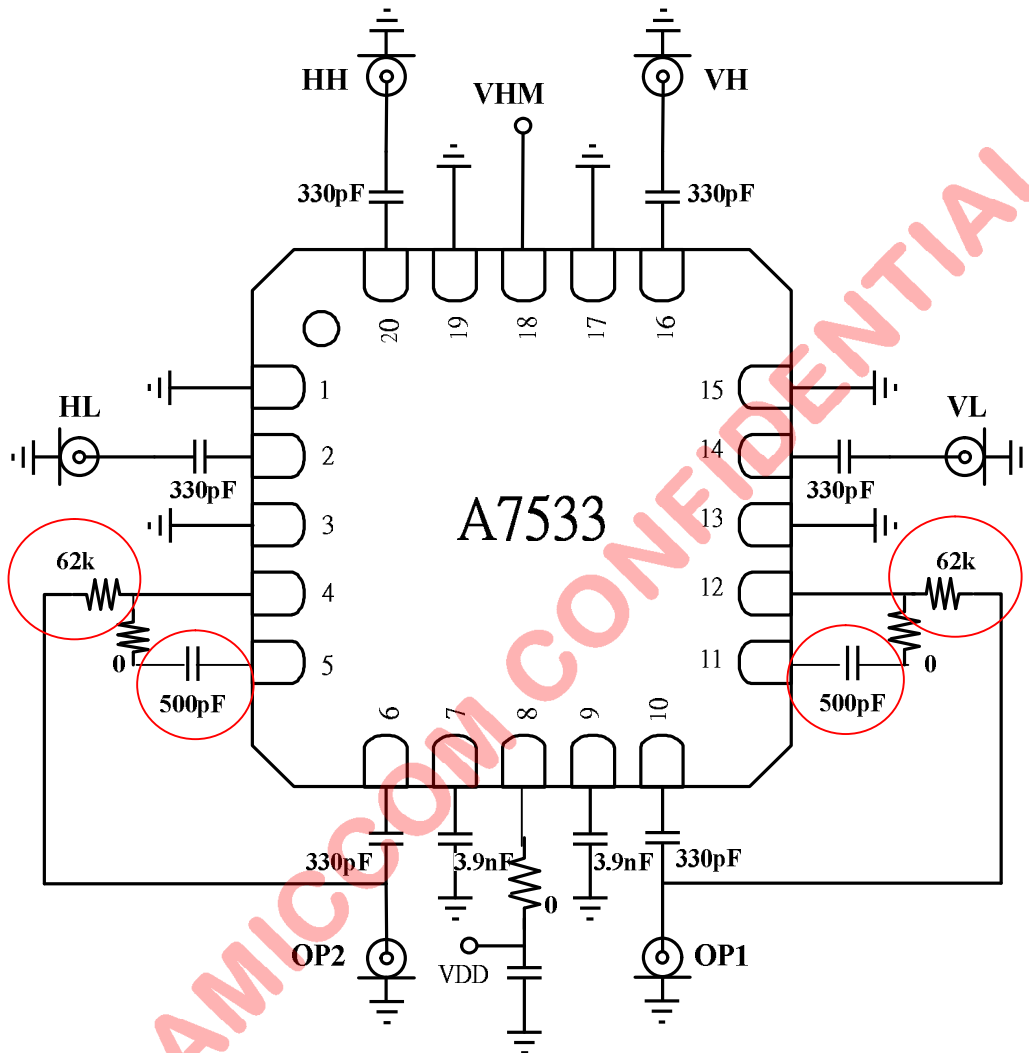

Note 1
Note 2
Note 3

62K ohm resistors shall be kept in 1% tolerance.
If 500 pF is not available, 470 pF is also acceptable.
All capacitors shall be within 10 % tolerance. But, 5 % tolerance is preferred.

9 Truth Table

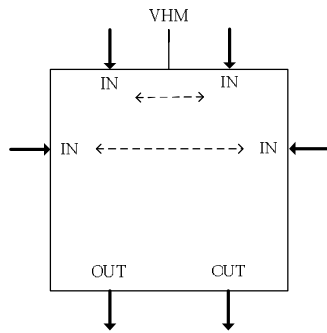

Above figure show the function of VHM. (Vertical/Horizontal mirror)

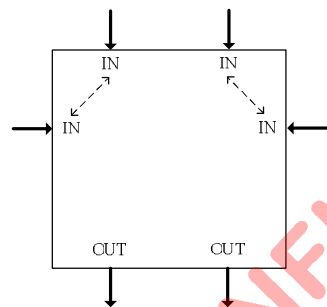

Above figure show the different between 7533A and 7533B (High/Low band upside down)

V1,V2 = 0 means DC voltage =9.5~14V, V1, V2=1 means DC voltage =15.5~19V
 T1, T2=0 means 22KHz tone disappeared. T1, T2=1 means 22KHz tone appeared.

A7533A When pin 18 "VHM" connected to GND

State	Control Input				Output to Input State	
	V1	T1	V2	T2	OP1	OP2
1	0	0	0	0	HH	HH
2	0	0	0	1	HH	HL
3	0	0	1	0	HH	VH
4	0	0	1	1	HH	VL
5	0	1	0	0	HL	HH
6	0	1	0	1	HL	HL
7	0	1	1	0	HL	VH
8	0	1	1	1	HL	VL
9	1	0	0	0	VH	HH
10	1	0	0	1	VH	HL
11	1	0	1	0	VH	VH
12	1	0	1	1	VH	VL
13	1	1	0	0	VL	HH
14	1	1	0	1	VL	HL
15	1	1	1	0	VL	VH
16	1	1	1	1	VL	VL

A7533A When pin 18 “VHM” open. Vertical and Horizontal will be mirror.

State	Control Input				Output to Input State	
	V1	T1	V2	T2	OP1	OP2
1	0	0	0	0	VH	VH
2	0	0	0	1	VH	VL
3	0	0	1	0	VH	HH
4	0	0	1	1	VH	HL
5	0	1	0	0	VL	VH
6	0	1	0	1	VL	VL
7	0	1	1	0	VL	HH
8	0	1	1	1	VL	HL
9	1	0	0	0	HH	VH
10	1	0	0	1	HH	VL
11	1	0	1	0	HH	HH
12	1	0	1	1	HH	HL
13	1	1	0	0	HL	VH
14	1	1	0	1	HL	VL
15	1	1	1	0	HL	HH
16	1	1	1	1	HL	HL

A7533B When pin 18 “VHM” connected to GND

State	Control Input				Output to Input State	
	V1	T1	V2	T2	OP1	OP2
1	0	0	0	0	HL	HL
2	0	0	0	1	HL	HH
3	0	0	1	0	HL	VL
4	0	0	1	1	HL	VH
5	0	1	0	0	HH	HL
6	0	1	0	1	HH	HH
7	0	1	1	0	HH	VL
8	0	1	1	1	HH	VH
9	1	0	0	0	VL	HL
10	1	0	0	1	VL	HH
11	1	0	1	0	VL	VL
12	1	0	1	1	VL	VH
13	1	1	0	0	VH	HL
14	1	1	0	1	VH	HH
15	1	1	1	0	VH	VL
16	1	1	1	1	VH	VH

A7533B When pin 18 “VHM” open. Vertical and Horizontal will be mirror.

State	Control Input				Output to Input State	
	V1	T1	V2	T2	OP1	OP2
1	0	0	0	0	VL	VL
2	0	0	0	1	VL	VH
3	0	0	1	0	VL	HL
4	0	0	1	1	VL	HH
5	0	1	0	0	VH	VL
6	0	1	0	1	VH	VH
7	0	1	1	0	VH	HL
8	0	1	1	1	VH	HH
9	1	0	0	0	HL	VL
10	1	0	0	1	HL	VH
11	1	0	1	0	HL	HL
12	1	0	1	1	HL	HH
13	1	1	0	0	HH	VL
14	1	1	0	1	HH	VH
15	1	1	1	0	HH	HL
16	1	1	1	1	HH	HH

10 Ordering Information

Part No.	Package	Units Per Reel / Tray
A75X33AQF/Q	QFN20L, Pb Free, Tape & Reel, -40°C ~ 85°C	3K
A75X33AQF	QFN20L, Pb Free, Tray, -40°C ~ 85°C	490EA
A75X33BQF/Q	QFN20L, Pb Free, Tape & Reel, -40°C ~ 85°C	3K
A75X33BQF	QFN20L, Pb Free, Tray, -40°C ~ 85°C	490EA

11 Package Information

QFN 20L (4 X 4 X 0.8mm) Outline Dimensions

unit: inches/mm

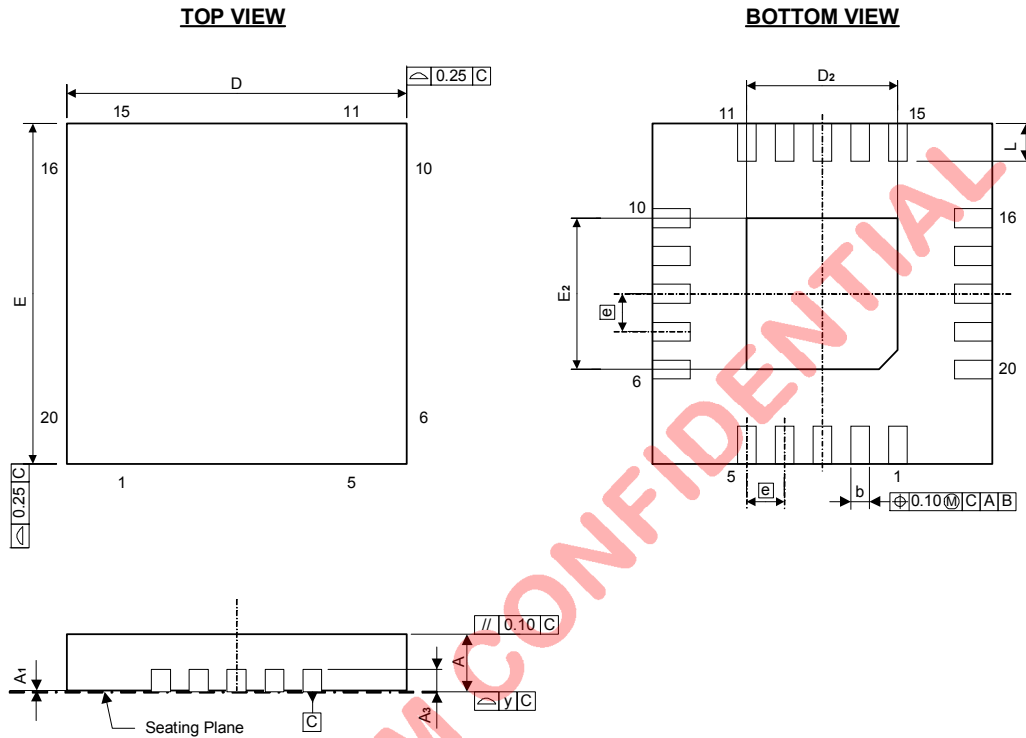

Symbol	Dimensions in inches			Dimensions in mm		
	Min	Nom	Max	Min	Nom	Max
A	0.028	0.030	0.032	0.70	0.75	0.80
A1	0.000	0.001	0.002	0.00	0.02	0.05
A3	0.008 REF			0.203 REF		
b	0.007	0.010	0.012	0.18	0.25	0.30
D	0.154	0.158	0.161	3.90	4.00	4.10
D2	0.075	0.079	0.083	1.90	2.00	2.10
E	0.154	0.158	0.161	3.90	4.00	4.10
E2	0.075	0.079	0.083	1.90	2.00	2.10
[e]	0.020 BSC			0.50 BSC		
L	0.012	0.016	0.020	0.30	0.40	0.50
y	0.003			0.08		

12 Top Marking Information

A75X33AQF

- Part No. : **A75X33AQF**
- Pin Count : **20**
- Package Type : **QFN**
- Dimension : **4*4 mm**
- Mark Method : **Laser Mark**
- Character Type : **Arial**

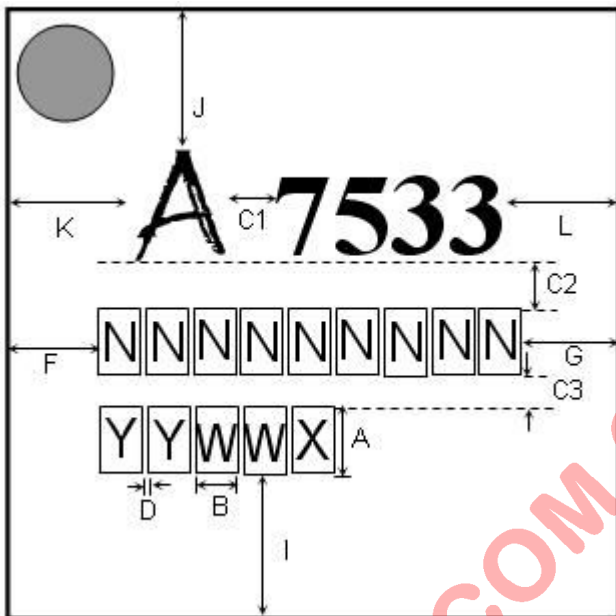

A : 0.55
B : 0.36
C1 : 0.25 C2 : 0.3 C3 : 0.2
D : 0.03
A1 : 0.75
B2 : 0.7

Y Y W W

: DATECODE

X

: PKG HOUSE ID

N N N N N N N N N N

: LOT NO.
(max. 9 characters)

F=G
I=J
K=L

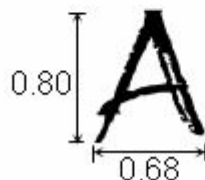

A75X33BQF

- Part No. : **A75X33BQF**
- Pin Count : **20**
- Package Type : **QFN**
- Dimension : **4*4 mm**
- Mark Method : **Laser Mark**
- Character Type : **Arial**

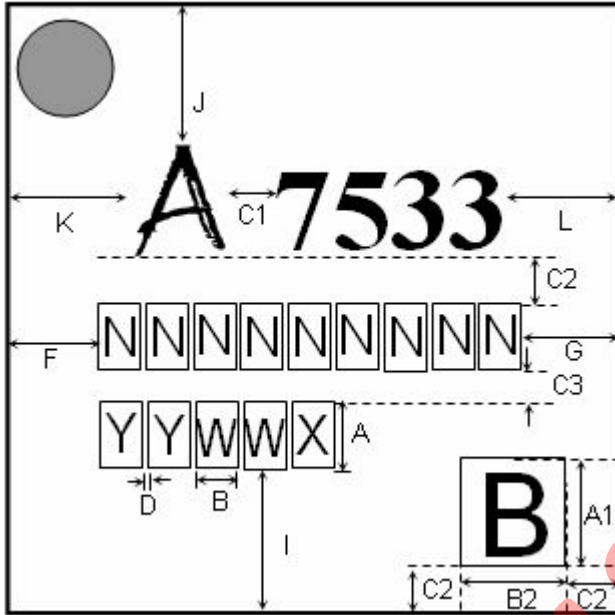

A : 0.55
B : 0.36
C1 : 0.25 C2 : 0.3 C3 : 0.2
D : 0.03
A1 : 0.75
B2 : 0.7

YYWW : DATECODE
X : PKG HOUSE ID
NNNNNNNNNN : LOT NO.
 (max. 9 characters)

F=G
I=J
K=L

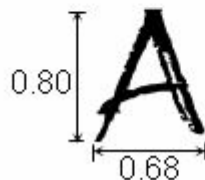

13 Reflow Profile

LEAD FREE (GREEN) PROFILE :

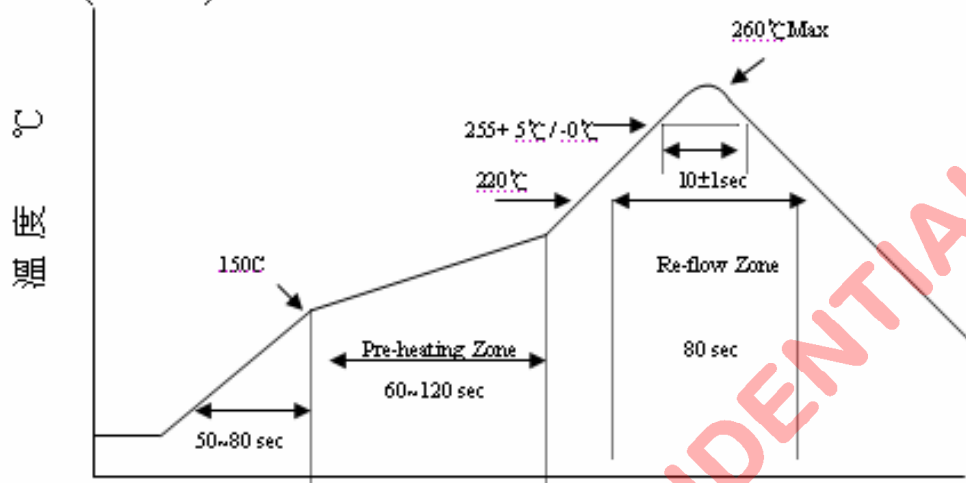

Actual Measurement Graph



14 Tape Reel Information

Cover / Carrier Tape Dimension

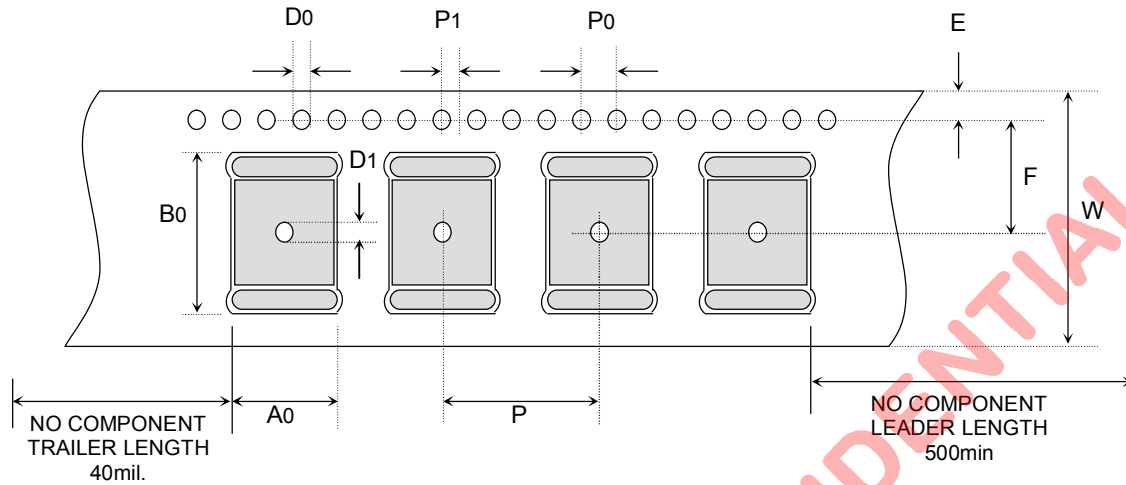

11 EA IC

60cm±4cm

TYPE	P	A0	B0	P0	P1	D0	D1	E	F	W
20 QFN 4*4	8	4.35	4.35	4.0	2.0	1.5	1.5	1.75	5.5	12
24 QFN 4*4	8	4.4	4.4	4.0	2.0	1.5	1.5	1.75	5.5	12
32 QFN 5*5	8	5.25	5.25	4.0	2.0	1.5	1.5	1.75	5.5	12
48 QFN 7*7	12	7.25	7.25	4.0	2.0	1.5	1.5	1.75	7.5	16
DFN-10	4	3.2	3.2	4.0	2.0	1.5	-	1.75	1.9	8
20 SSOP	12	8.2	7.5	4.0	2.0	1.5	1.5	1.75	7.5	16
24 SSOP	12	8.2	8.8	4.0	2.0	1.5	1.5	1.75	7.5	16
28 SSOP (150mil)	8	6	10	4.0	2.0	1.5	1.5	1.75	7.5	16

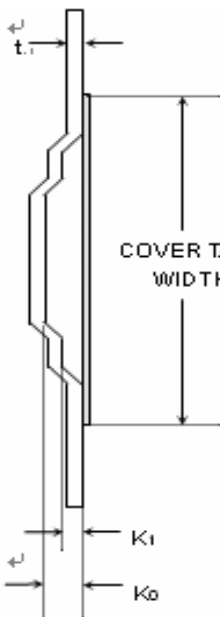

TYPE	K0	K1	t
20 QFN (4X4)	1.1	-	0.3
24 QFN (4X4)	1.4	-	0.3
32 QFN (5X5)	1.1	-	0.3
48 QFN (7X7)	1.1	-	0.3
DFN-10	0.75	-	0.25
20 SSOP	2.5	-	0.3
24 SSOP	2.1	-	0.3
28 SSOP (150mil)	2.5	-	0.3

COVER TAPE WIDTH
9.2
9.2
9.2
13.3
8
13.3
13.3
12.5

Unit : mm

CROSSSECTION

REEL DIMENSIONS

UNIT IN mm

TYPE	G	N	T	M	D	K	L	R
20 QFN(4X4) 24 QFN(4X4) 32 QFN(5X5) DFN-10	12.8+0.6/- 0.4	100 REF	18.2(MAX)	1.75±0.25	13.0+0.5/- 0.2	2.0±0.5	330+ 0.00/-1.0	20.2
48 QFN(7X7)	16.8+0.6/- 0.4	100 REF	22.2(MAX)	1.75±0.25	13.0+0.5/- 0.2	2.0±0.5	330+ 0.00/-1.0	20.2
28 SSOP (150mil)	20.4+0.6/- 0.4	100 REF	25(MAX)	1.75±0.25	13.0+0.5/- 0.2	2.0±0.5	330+ 0.00/-1.0	20.2
20 SSOP 24 SSOP	16.4+2.0/- 0.0	100 REF	22.4(MAX)	1.75±0.25	13.0+0.2/- 0.2	1.9±0.4	330+ 0.00/-1.0	20.2

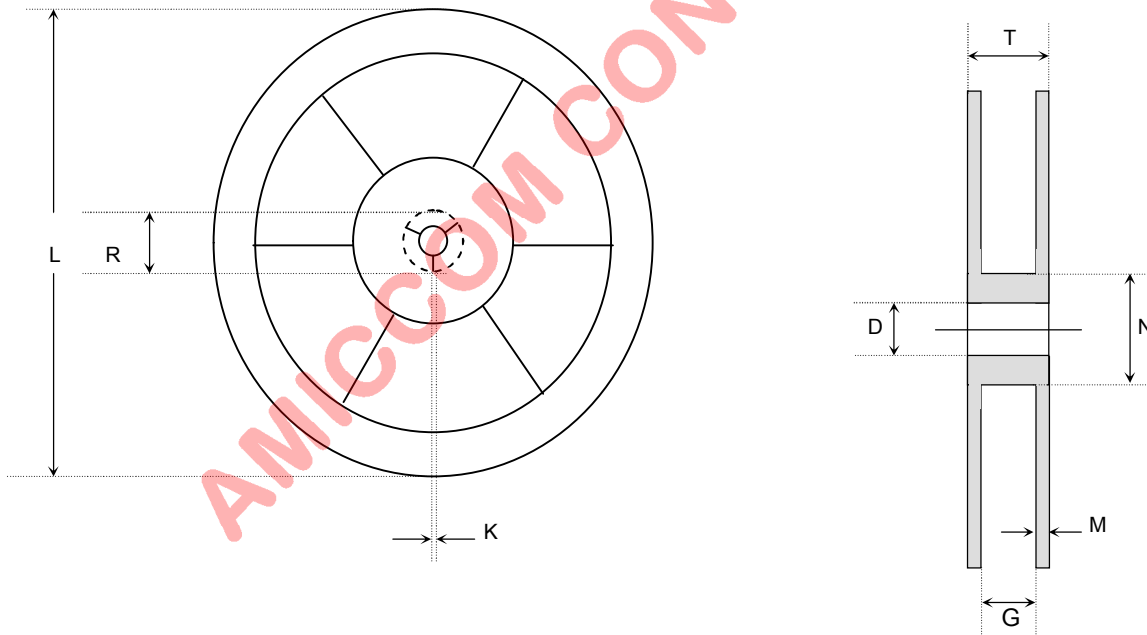

USE OF THE REEL FOR 'Q' TYPE

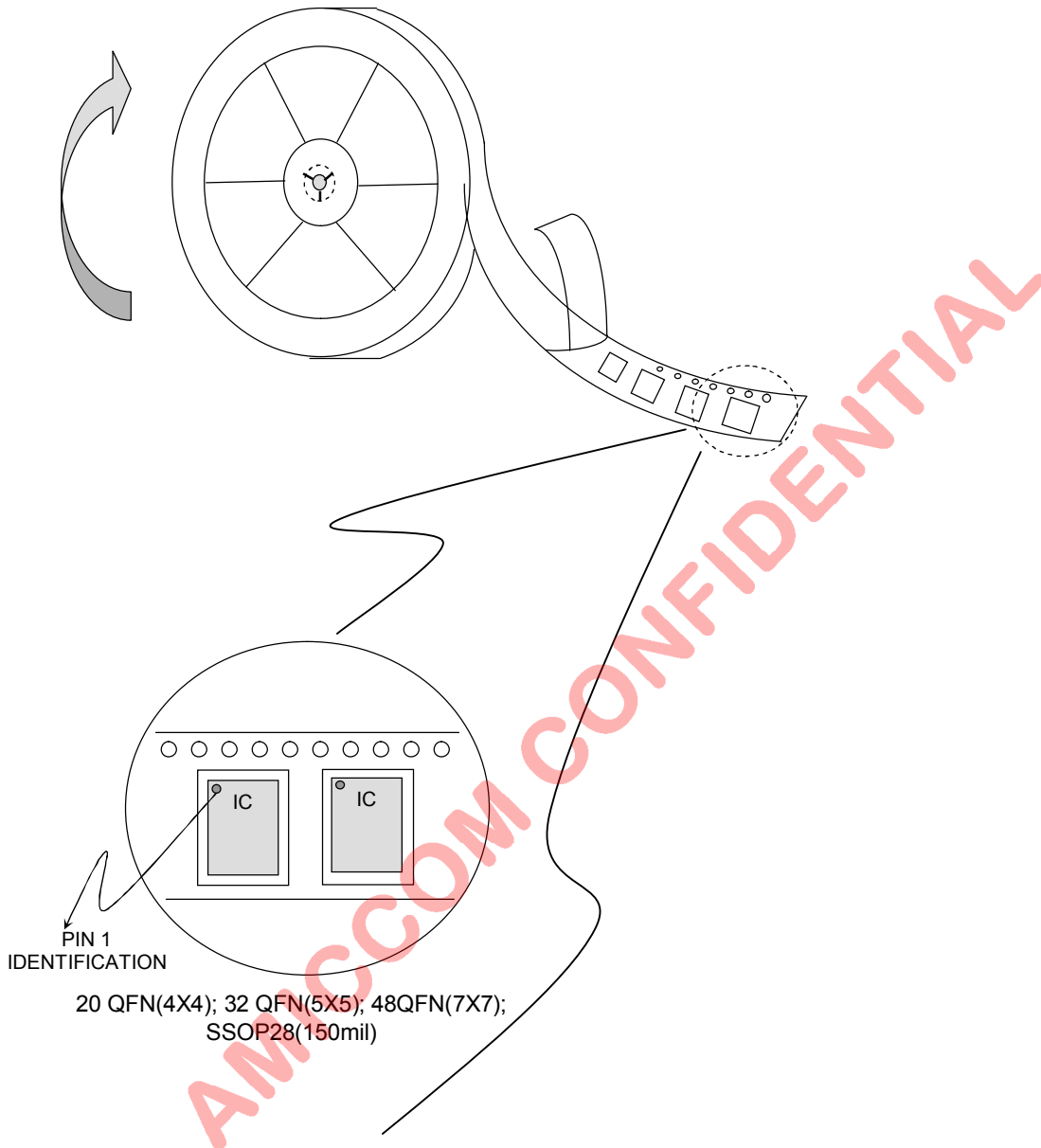

15 Product Status

Data Sheet Identification	Product Status	Definition
Objective	Planned or Under Development	This data sheet contains the design specifications for product development. Specifications may change in any manner without notice.
Preliminary	Engineering Samples and First Production	This data sheet contains preliminary data, and supplementary data will be published at a later date. AMICCOM reserves the right to make changes at any time without notice in order to improve design and supply the best possible product.
No Identification	Noted Full Production	This data sheet contains the final specifications. AMICCOM reserves the right to make changes at any time without notice in order to improve design and supply the best possible product.
Obsolete	Not In Production	This data sheet contains specifications on a product that has been discontinued by AMICCOM. The data sheet is printed for reference information only.

RF ICs AMICCOM



Headquarter

5F, No.2, Li-Hsin Rd. 6, Hsinchu Science Park,
Taiwan 30078
Tel: 886-3-5785818

Taipei Office

7F, No.407, Rueiguang Rd., Nei-Hu, Taipei,
Taiwan 11492
Tel:886-2-26275818

Web Site

<http://www.amiccom.com.tw>

