

**ASUS® A7V266**

JumperFree™ DDR DRAM

266MHz FSB AGP Pro/4X

Socket A Motherboard

**USER'S MANUAL**

# USER'S NOTICE

---

No part of this manual, including the products and software described in it, may be reproduced, transmitted, transcribed, stored in a retrieval system, or translated into any language in any form or by any means, except documentation kept by the purchaser for backup purposes, without the express written permission of ASUSTeK COMPUTER INC. ("ASUS").

ASUS PROVIDES THIS MANUAL "AS IS" WITHOUT WARRANTY OF ANY KIND, EITHER EXPRESS OR IMPLIED, INCLUDING BUT NOT LIMITED TO THE IMPLIED WARRANTIES OR CONDITIONS OF MERCHANTABILITY OR FITNESS FOR A PARTICULAR PURPOSE. IN NO EVENT SHALL ASUS, ITS DIRECTORS, OFFICERS, EMPLOYEES OR AGENTS BE LIABLE FOR ANY INDIRECT, SPECIAL, INCIDENTAL, OR CONSEQUENTIAL DAMAGES (INCLUDING DAMAGES FOR LOSS OF PROFITS, LOSS OF BUSINESS, LOSS OF USE OR DATA, INTERRUPTION OF BUSINESS AND THE LIKE), EVEN IF ASUS HAS BEEN ADVISED OF THE POSSIBILITY OF SUCH DAMAGES ARISING FROM ANY DEFECT OR ERROR IN THIS MANUAL OR PRODUCT.

Product warranty or service will not be extended if: (1) the product is repaired, modified or altered, unless such repair, modification or alteration is authorized in writing by ASUS; or (2) the serial number of the product is defaced or missing.

Products and corporate names appearing in this manual may or may not be registered trademarks or copyrights of their respective companies, and are used only for identification or explanation and to the owners' benefit, without intent to infringe.

- Intel and Pentium are registered trademarks of Intel Corporation.
- VIA is a registered trademark of VIA Technologies, Inc.
- 3Com is a registered trademark of 3Com Corporation.
- C-Media is a registered trademark of C-Media Electronics Inc.
- Windows and MS-DOS are registered trademarks of Microsoft Corporation.
- Adobe and Acrobat are registered trademarks of Adobe Systems Incorporated.
- Trend and ChipAwayVirus are trademarks of Trend Micro, Inc.
- Symbios is a registered trademark of Symbios Logic Corporation.

The product name and revision number are both printed on the product itself. Manual revisions are released for each product design represented by the digit before and after the period of the manual revision number. Manual updates are represented by the third digit in the manual revision number.

For previous or updated manuals, BIOS, drivers, or product release information, contact ASUS at <http://www.asus.com.tw> or through any of the means indicated on the following page.

SPECIFICATIONS AND INFORMATION CONTAINED IN THIS MANUAL ARE FURNISHED FOR INFORMATIONAL USE ONLY, AND ARE SUBJECT TO CHANGE AT ANY TIME WITHOUT NOTICE, AND SHOULD NOT BE CONSTRUED AS A COMMITMENT BY ASUS. ASUS ASSUMES NO RESPONSIBILITY OR LIABILITY FOR ANY ERRORS OR INACCURACIES THAT MAY APPEAR IN THIS MANUAL, INCLUDING THE PRODUCTS AND SOFTWARE DESCRIBED IN IT.

**Copyright © 2001 ASUSTeK COMPUTER INC. All Rights Reserved.**

Product Name: **ASUS A7V266**  
Manual Revision: **1.05 E766**  
Release Date: **JUNE 2001**

# ASUS CONTACT INFORMATION

---

## ASUSTeK COMPUTER INC. (Asia-Pacific)

### *Marketing*

Address: 150 Li-Te Road, Peitou, Taipei, Taiwan 112  
Telephone: +886-2-2894-3447  
Fax: +886-2-2894-3449  
Email: info@asus.com.tw

### *Technical Support*

MB/Others (Tel): +886-2-2890-7121 (English)  
Notebook (Tel): +886-2-2890-7122 (English)  
Desktop/Server (Tel): +886-2-2890-7123 (English)  
Fax: +886-2-2893-7775  
Email: tsd@asus.com.tw  
WWW: www.asus.com.tw  
FTP: ftp.asus.com.tw/pub/ASUS

## ASUS COMPUTER INTERNATIONAL (America)

### *Marketing*

Address: 6737 Mowry Avenue, Mowry Business Center, Building 2  
Newark, CA 94560, USA  
Fax: +1-510-608-4555  
Email: tmd1@asus.com

### *Technical Support*

Fax: +1-510-608-4555  
Email: tsd@asus.com  
WWW: www.asus.com  
FTP: ftp.asus.com/Pub/ASUS

## ASUS COMPUTER GmbH (Europe)

### *Marketing*

Address: Harkortstr. 25, 40880 Ratingen, BRD, Germany  
Fax: +49-2102-442066  
Email: sales@asuscom.de (for marketing requests only)

### *Technical Support*

Hotline: MB/Others: +49-2102-9599-0 Notebook: +49-2102-9599-10  
Fax: +49-2102-9599-11  
Support (Email): www.asuscom.de/de/support (for online support)  
WWW: www.asuscom.de  
FTP: ftp.asuscom.de/pub/ASUSCOM

# CONTENTS

---

<b>1. INTRODUCTION .....</b>	<b>7</b>
1.1 How This Manual Is Organized .....	7
1.2 Item Checklist .....	7
<b>2. FEATURES .....</b>	<b>8</b>
2.1 ASUS A7V266 Motherboard .....	8
2.1.1 Specifications .....	8
2.1.2 Performance .....	10
2.1.3 Intelligence .....	11
2.2 Motherboard Components .....	12
2.2.1 Component Locations .....	13
<b>3. HARDWARE SETUP .....</b>	<b>14</b>
3.1 Motherboard Layout .....	14
3.2 Layout Contents .....	15
3.3 Hardware Setup Procedure .....	17
3.4 Motherboard Settings .....	17
3.5 System Memory .....	25
3.5.1 DDR DIMM Support .....	25
3.5.1 General DIMM Notes .....	26
3.5.2 Memory Installation .....	26
3.6 Central Processing Unit (CPU) .....	27
3.7 Expansion Cards .....	28
3.7.1 Installing an Expansion Card .....	28
3.7.2 Assigning IRQs for Expansion Cards .....	29
3.7.3 Accelerated Graphics Port (AGP) Pro Slot .....	30
3.7.4 Advanced Communication Riser (ACR) Slot .....	30
3.8 Connectors .....	31
3.8.1 External Connectors .....	31
3.9 Starting Up the First Time .....	44
<b>4. BIOS SETUP .....</b>	<b>45</b>
4.1 Managing and Updating Your BIOS .....	45
4.1.1 Upon First Use of the Computer System .....	45
4.1.2 Updating BIOS Procedures .....	47
4.2 BIOS Setup Program .....	49
4.2.1 BIOS Menu Bar .....	50
4.2.2 Legend Bar .....	50

# CONTENTS

---

4.3	Main Menu .....	52
4.3.1	Primary & Secondary Master/Slave .....	53
4.3.2	Keyboard Features .....	56
4.4	Advanced Menu .....	58
4.4.1	Chip Configuration .....	62
4.4.2	I/O Device Configuration .....	65
4.4.3	PCI Configuration .....	67
4.5	Power Menu .....	69
4.5.1	Power Up Control .....	71
4.5.2	Hardware Monitor .....	73
4.6	Boot Menu .....	74
4.7	Exit Menu .....	76
<b>5.</b>	<b>SOFTWARE SETUP .....</b>	<b>79</b>
5.1	Install Operating System .....	79
5.2	Start Windows .....	79
5.3	A7V266 Series Motherboard Support CD .....	80
<b>6.</b>	<b>SOFTWARE REFERENCE .....</b>	<b>81</b>
6.1	Winbond Smart Manager .....	83
6.2	ASUS PC Probe .....	87
6.3	Multi-Channel Audio Feature Setup .....	92
6.4	ASUS LiveUpdate .....	94
6.5	3Deep Color Tuner .....	95
6.6	CyberLink PowerPlayer SE .....	97
6.7	CyberLink PowerDVD .....	98
6.8	CyberLink VideoLive Mail .....	99
<b>6.</b>	<b>SOFTWARE REFERENCE .....</b>	<b>101</b>
7.1	Modem Riser .....	101
7.1.1	56K Software Modem .....	101
7.1.2	Primary/Secondary MR .....	101
7.1.3	Hardware Installation Procedure .....	101
7.1.4	Software Setup in Windows 98 .....	102
7.2	Glossary .....	103
<b>INDEX</b>	<b>.....</b>	<b>107</b>

# FCC & DOC COMPLIANCE

---

## ***Federal Communications Commission Statement***

This device complies with FCC Rules Part 15. Operation is subject to the following two conditions:

- This device may not cause harmful interference, and
- This device must accept any interference received, including interference that may cause undesired operation.

This equipment has been tested and found to comply with the limits for a Class B digital device, pursuant to Part 15 of the FCC Rules. These limits are designed to provide reasonable protection against harmful interference in a residential installation. This equipment generates, uses and can radiate radio frequency energy and, if not installed and used in accordance with manufacturer's instructions, may cause harmful interference to radio communications. However, there is no guarantee that interference will not occur in a particular installation. If this equipment does cause harmful interference to radio or television reception, which can be determined by turning the equipment off and on, the user is encouraged to try to correct the interference by one or more of the following measures:

- Re-orient or relocate the receiving antenna.
- Increase the separation between the equipment and receiver.
- Connect the equipment to an outlet on a circuit different from that to which the receiver is connected.
- Consult the dealer or an experienced radio/TV technician for help.

**WARNING!** Any changes or modifications to this product not expressly approved by the manufacturer could void any assurances of safety or performance and could result in violation of Part 15 of the FCC Rules.

Reprinted from the Code of Federal Regulations #47, part 15.193, 1993. Washington DC: Office of the Federal Register, National Archives and Records Administration, U.S. Government Printing Office.

## ***Canadian Department of Communications Statement***

This digital apparatus does not exceed the Class B limits for radio noise emissions from digital apparatus set out in the Radio Interference Regulations of the Canadian Department of Communications.

**This Class B digital apparatus complies with Canadian ICES-003.**

**Cet appareil numérique de la classe B est conforme à la norme NMB-003 du Canada.**

# 1. INTRODUCTION

## 1.1 How This Manual Is Organized

This manual is divided into the following sections:

1. INTRODUCTION	Manual information and checklist
2. FEATURES	Production information and specifications
3. HARDWARE SETUP	Instructions on setting up the motherboard.
4. BIOS SETUP	Instructions on setting up the BIOS
5. SOFTWARE SETUP	Instructions on setting up the included software
6. SOFTWARE REFERENCE	Reference material for the included software
7. APPENDIX	Optional items and general reference

## 1.2 Item Checklist

Check that your package is complete. If you discover damaged or missing items, contact your retailer.

### Package Contents

- (1) ASUS Motherboard
- (1) 40-pin 80-conductor ribbon cable for internal UltraDMA100/66//33 IDE drives
- (1) Ribbon cable for two 3.5" floppy disk drives
- (1) ASUS Support CD with drivers and utilities
- (1) Bag of spare jumper caps
- (1) ASUS 2-port USB Connector Set
- (1) User's Manual

### Optional Items

- ASUS IrDA-compliant infrared module

### Special Optional Item: *The Read2-In-01 SmartCard Reader*

Power up your PC using a Smart Card. The TUSL2 supports the latest PC/SC compliant Smart Card Reader: the *Read2-In-01*. Visit the manufacturer's website: [www.tzt.com.tw](http://www.tzt.com.tw) or ask your local dealer for product availability. See *Section 6, Software Reference*, for more detailed information about using the *Winbond Smart Manager* software.



## 2. FEATURES

---

### 2.1 ASUS A7V266 Motherboard

The ASUS A7V266 motherboard is targeted diversely for home PCs, workstations and servers. Powered by AMD® Athlon™/Duron™ processor and bundled with advanced features to provide superlative performance, the A7V266 efficiently complies with today's demand for a flexible high-integration system.

#### 2.1.1 Specifications

- **AMD® Athlon™/Duron™ Processor Support:** Supports Socket A-based AMD Athlon™/Duron™ processors.
- **North Bridge System Chipset:** Features the VIA® VT8366 North Bridge that supports AGP 4X/2X mode, 133/100MHz Front Side Bus (FSB), and 266/200MHz memory bus.
- **South Bridge System Chipset:** VIA® VT8233 integrated peripheral controller supports UltraDMA/100/66/33 for burst mode data transfer rates of up to 100MB/sec, and USB controller with three root hubs for six USB ports.
- **PC2100 / PC1600 DDR Support:** Equipped with three Double Data Rate Dual Inline Memory Module (DDR DIMM) sockets to support up to 3GB of DDR DRAM. DDR DRAM is the newest memory standard with the highest bandwidth and lowest latency currently available and dramatically improves the memory system's ability to service, among others, high multimedia requirements. (*Caution:* Do not attempt to use SDRAM modules.)
- **JumperFree™ Mode:** Allows processor settings and easy overclocking of frequency and Vcore voltage through BIOS. Easy-to-use DIP switches come with the motherboard board to allow manual adjustment of the processor external/internal frequency.
- **UltraDMA/100 Support:** Comes with an onboard PCI Bus Master IDE controller with two connectors that support four IDE devices on two channels. Supports UltraDMA/100, UltraDMA/66, UltraDMA/33, PIO Modes 3 & 4, Bus Master IDE DMA Mode 2, and Enhanced IDE devices, such as DVD-ROM, CD-ROM, CD-R/RW, LS-120, and Tape Backup drives.
- **AGP Pro Slot:** Comes with an Accelerated Graphics Port (AGP) Pro slot that supports high performance AGP cards targeted at 3D graphical applications supporting 133MHz 4X mode. The slot is backward compatible with AGP 4X/2X cards.
- **PC Health Monitoring:** Provides an easy way to test and manage system status information, such as CPU and system voltages, temperatures, and fan status through the onboard hardware ASUS ASIC and the bundled ASUS PC Probe.
- **SMBus:** Features the System Management Bus interface used to physically transport commands and information between SMBus devices.



## 2. FEATURES

---

- **PCI Expansion Slots:** Five 32-bit PCI (Rev. 2.2) expansion slots that support Bus Master PCI cards, like SCSI or LAN cards, with 133MB/s maximum throughput.
- **Advanced Communication Riser (ACR):** Features an ACR slot for the Advanced Communication Riser card. The ACR specification supports modem, audio and LAN technologies. The ACR is backward compatible with the Audio Modem Riser (AMR).
- **Wake-On-LAN:** Supports Wake-On-LAN activity through an optional ASUS PCI-L101 10 /100 Fast Ethernet PCI card.
- **Wake-On-Ring:** Supports Wake-On-Ring activity through a PCI modem card.
- **Super Multi-I/O:** The multi-I/O chipset offers complete support for a variety of I/O functions. Provides two high-speed UART compatible serial ports and one parallel port with EPP and ECP capabilities. UART2 can also be directed from COM2 to the Infrared Module for wireless connections. The Super I/O controller also supports a floppy disk drive, PS/2 keyboard, and PS/2 mouse.
- **Smart BIOS:** 2Mb firmware provides Vcore and CPU/DDR SDRAM frequency adjustments, boot block write protection, and HD/SCSI/MO/ZIP/CD/Floppy boot selection.
- **Enhanced ACPI and Anti-Boot Virus Protection:** Programmable BIOS (Flash EEPROM) that offers enhanced ACPI for Windows 98/2000/ME compatibility, built-in firmware-based virus protection, and autodetection of most devices for a virtual automatic setup.
- **IrDA:** Supports an optional infrared port module for wireless interface.
- **Desktop Management Interface (DMI):** Supports DMI through BIOS that allows hardware to communicate within a standard protocol and create a higher level of compatibility. (Requires DMI-enabled components.)
- **Onboard LED:** Comes with a power LED that lights up if there is any standby power on the motherboard. This LED acts as a reminder to turn off the system power before plugging or unplugging devices to prevent damage to the motherboard, peripherals, and other system components.
- **Easy Connectivity and System Information Access:** Supports an optional ASUS iPanel, an easy-to-access box with system diagnostic display area, system status LEDs, USB ports, and hot keys. The AFPANEL connector on the motherboard accommodates the ASUS iPanel.

## 2. FEATURES

---

### 2.1.2 Performance

- **DDR DRAM Optimized Performance:** This motherboard supports a new generation memory, Double Data Rate (DDR) Dynamic Random Access Memory (DDR DRAM). This new memory technology increases performance by executing two actions per clock cycle, resulting in data transfer rates of up to 2.1 GB/s for 133MHz DDR SDRAM and 1.6GB/s for 100MHz DDR SDRAM.
- **Onboard Audio:** Audio models come with the six-channel C-Media CMI8738 PCI audio controller that supplies HRTF 3D positional audio functions. The chip supports software access to PC DVD 5.1/6.1 and AC-3/DTS via SPDIF. Other integrative features include: full DVD playback, Pctel 56K modem, and even Karaoke echo effects. The chip offers 24-bit SPDIF digital recording and playback with additional support for legacy audio SBPRO™ and FM emulator/DLS wavetable music synthesis. A software package helps setup the multi-channel PC sound system.
- **ACPI Ready:** Advanced Configuration Power Interface (ACPI) provides more Energy Saving Features for operating systems that support OS Direct Power Management (OSPM) functionality. With these features employed in the OS, PCs can be ready around the clock but comply with energy saving standards. To fully utilize the ACPI benefits, use an ACPI-supported OS such as Windows 98.
- **Smartcard Reader Connector:** Features a connector that provides the convenience of PS/SC compatible Smart Card security along with support for a multitude of new financial, telephonic, and mobile access services.
- **PC'99 Compliant:** Both the BIOS and hardware levels of ASUS smart series motherboards are PC'99 compliant. The new PC'99 requirements for systems and components are based on the following high-level goals: Support for Plug-n-Play compatibility and power management for configuring and managing all system components, and 32-bit device drivers and installation procedures for Windows95/98/NT. Color-coded connectors and descriptive icons make identification easy as required by PC'99.
- **High-Speed Data Transfer Interface:** Support for UltraDMA/100 through the onboard IDE bus master controller triples the UltraDMA/33 burst transfer rate. UltraDMA/100 is backward compatible with DMA/66, DMA/33, and other existing DMA devices to save the need to upgrade current EIDE/IDE drives. (UltraDMA/66 requires a 40-pin 80-conductor cable).
- **Concurrent PCI:** Concurrent PCI allows multiple PCI transfers from PCI master busses to the memory and processor.

## 2. FEATURES

---

### 2.1.3 Intelligence

- **Auto Fan Off:** The system fans powers off automatically even in sleep mode. This function reduces both energy consumption and system noise, and is an important feature in implementing silent PC systems.
- **Dual Function Power Button:** Pushing the power button for less than 4 seconds when the system is in the working state places the system into one of two states: sleep mode or soft-off mode, depending on the BIOS or OS setting (*See PWR Button < 4 Secs in 4.5 Power Menu*). When the power button is pressed for more than 4 seconds, the system enters the soft-off mode regardless of the BIOS setting.
- **Fan Status Monitoring and Alarm:** To prevent system overheating and system damage, the CPU and system fans can be monitored for RPM and failure. All fans are set for its normal RPM range and alarm thresholds.
- **Power LED (requires ACPI OS support):** The power LED indicates the system status.
- **Remote Ring-On (requires modem):** This allows a computer to be turned on remotely through an internal or external modem. With this benefit on-hand, users can access vital information from their computers anywhere.
- **Temperature Monitoring and Alert:** CPU temperature is monitored by the ASUS ASIC through the CPU's internal thermal diode (on Pentium III and Celeron) to prevent system overheating and system damage.
- **Voltage Monitoring and Alert:** System voltage levels are monitored to ensure stable voltage to critical motherboard components. Voltage specifications are more critical for future processors, so monitoring is necessary to ensure proper system configuration and management.
- **Chassis Intrusion Detection:** Supports chassis-intrusion monitoring through the ASUS ASIC. A chassis intrusion event is kept in memory on battery power for more protection.

# 2. FEATURES

## 2.2 Motherboard Components

See opposite page for locations.

Location

<b>Processor Support</b>	Socket A for AMD® Athlon™ and Duron™ Processors .....	2
	Feature Setting DIP Switches .....	3
<b>Chipsets</b>	VIA® VT8366 North Bridge .....	1
	VIA® VT8233 South Bridge .....	9
	ASUS System Monitor controller .....	7
	C-Media® 6 Channel CMI8738 PCI audio controller .....	13
	Multi-I/O controller .....	18
	2Mbit Programmable Flash EEPROM .....	17
<b>Main Memory</b>	Maximum 3GB support	
	3 DDR DIMM Sockets .....	4
<b>Expansion Slots</b>	5 PCI Slots .....	15
	1 Accelerated Graphics Port (AGP) Pro/4X Slot .....	20
	1 Advanced Communication Riser .....	12
<b>System I/O</b>	1 Floppy Disk Drive Connector .....	10
	2 IDE Connectors (UltraDMA/100 Support) .....	6
	1 ASUS iPanel Connector .....	8
	1 Parallel Port .....	(Top) 23
	2 Serial Ports (COM1/COM2) .....	(Bottom) 22, 24
	USB Connectors (Port 0 & Port 1) .....	(Bottom) 25
	USB Connectors (Ports 2/3/4/5) .....	11
	1 PS/2 Mouse Connector .....	(Top) 26
	1 PS/2 Keyboard Connector .....	(Bottom) 26
<b>Hardware Monitoring</b>	System Voltage Monitoring (integrated in ASUS ASIC) .....	7
	3 Fan Power and Speed Monitoring Connectors	
<b>Special Feature</b>	Onboard LED .....	19
	Smart Card Connector ( <i>optional</i> ) .....	16
<b>Audio Features</b>	(on audio models only)	
	CMI8738 6-Channel Audio Controller .....	13
	1 ASUS iPanel Audio Connector .....	14
	1 Game/MIDI Port .....	(Top) 21
	1 Line Out Connector .....	(Bottom, left) 21
	1 Line In Connector .....	(Bottom, center) 21
	1 Microphone Connector .....	(Bottom, right) 21
	Internal Audio Connectors	
<b>Power</b>	ATX Power Supply Connector .....	5
<b>Form Factor</b>	ATX	

# 2. FEATURES

## 2.2.1 Component Locations

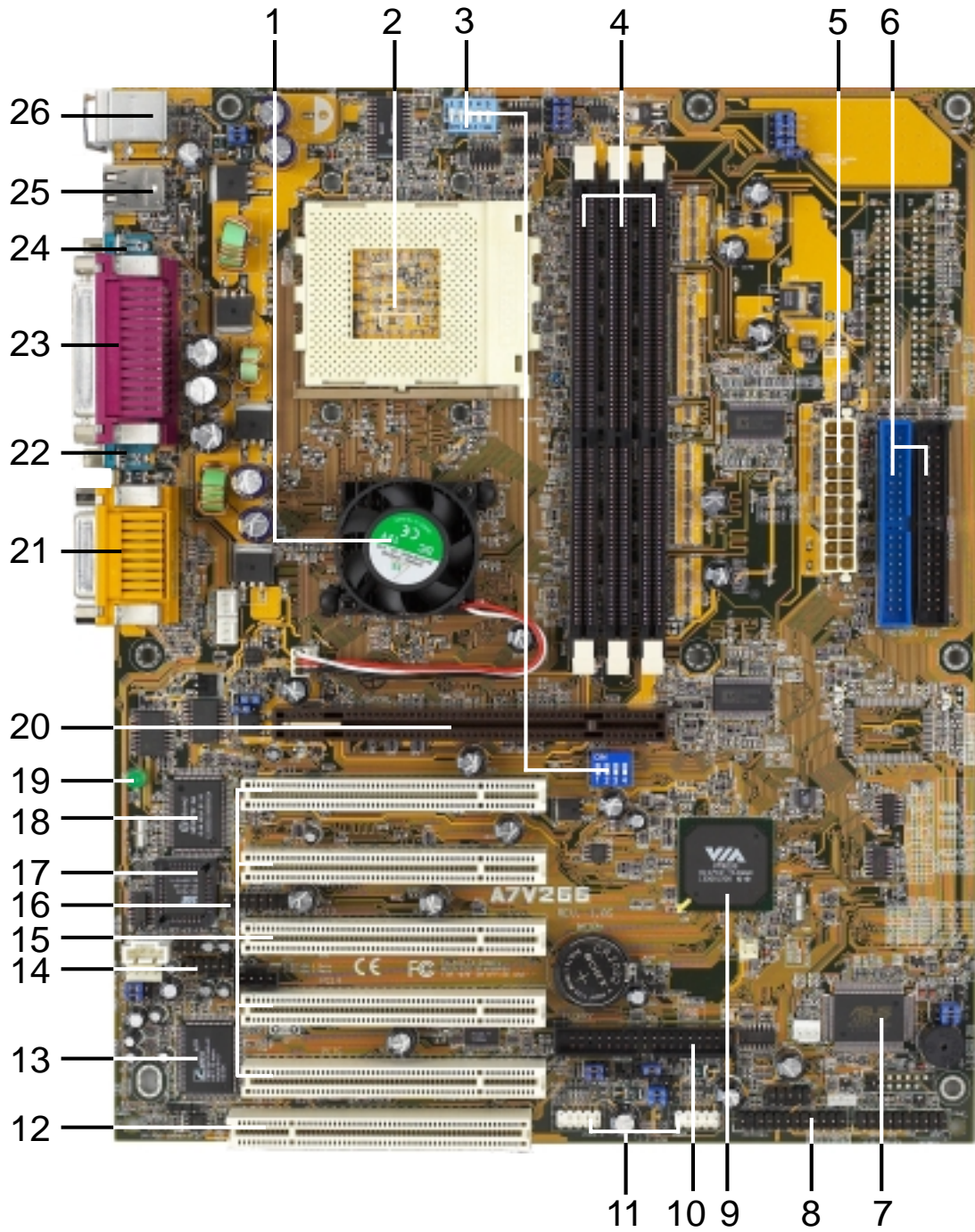

2. FEATURES  
Motherboard Parts

# 3. HARDWARE SETUP

## 3.1 Motherboard Layout

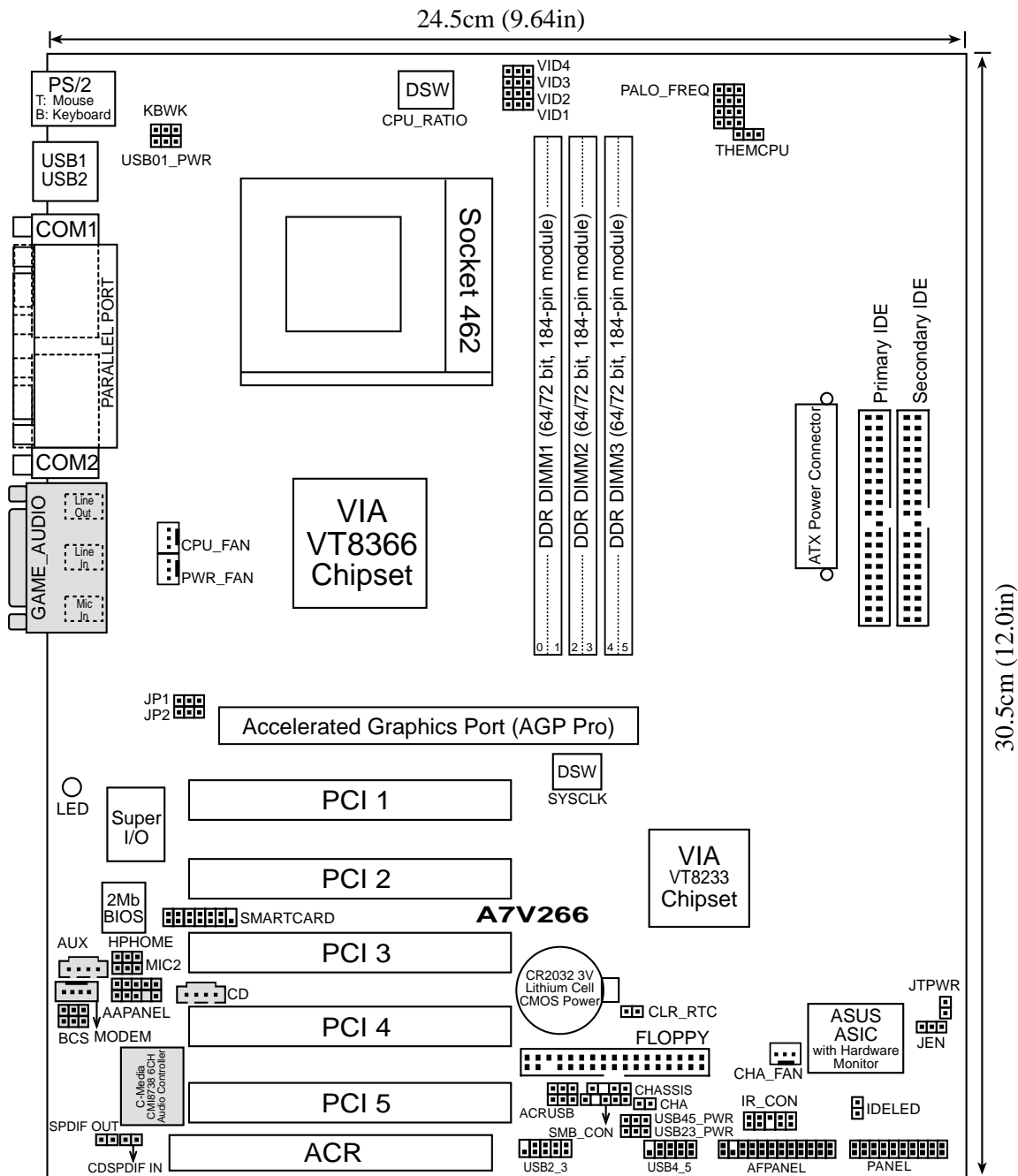

3. HW SETUP  
Motherboard Layout

# 3. HARDWARE SETUP

## 3.2 Layout Contents

### Motherboard Settings

- |   |  |
|---|--|
| 1) JEN                                  | p. 18 JumperFree Mode Setting (Disable / Enable)             |
| 2) DIP_SW                               | p. 19 CPU External Frequency Selection (Switches 1–4)        |
| 3) DSW                                  | p. 20 Manual CPU Ratio Settings (Switches 1-5)               |
| 4) PALO_FREQ                            | p. 20 FID setting (FID0-3)                                   |
| 5) JP1, JP2                             | p. 20 I/O Voltage Settings (2.5V/2.65V/2.75V/2.8V)           |
| 6) VID1, 2, 3, 4                        | p. 21 Voltage Regulator Output Volt. Setting (1.675V-1.85 V) |
| 7) CENTER/BASS,<br>BASS/CENTER          | p. 21 Bass Center Setting (Type 1 / Type 2)                  |
| 8) KBWK                                 | p. 22 Keyboard Power Up (Enable / Disable)                   |
| 9) ACRUSB1, ACRUSB2                     | p. 22 ACR/USB Selection (USB to Conn. / USB on ACR)          |
| 10) USB01_PWR<br>USB23_PWR<br>USB45_PWR | p. 23 USB Device Wake-up (+5V / +5VSB)                       |
| 11) CLR_RTC                             | p. 24 Clear RTC RAM (2 pin contact)                          |
| 12) THEMCPU                             | p. 24 Thermal Sensor CPU Setting (Athlon-Duron / Reserved)   |

### Expansion Slots/Sockets

- |                   |   |
|-------------------|---|
| 1) DIMM 1/2/3     | p. 25 System Memory Support             |
| 2) Socket 462 / A | p. 28 CPU Support                       |
| 3) PCI 1/2/3/4/5  | p. 29 32-bit PCI Bus Expansion Slots    |
| 4) AGP Pro        | p. 31 Accelerated Graphics Port Slot    |
| 5) ACR Slot       | p. 32 Advanced Communication Riser Slot |

### Connectors

- |               |   |
|---------------|---|
| 1) PS2KBMS    | p. 33 PS/2 Mouse Port (6 pin female)                          |
| 2) PS2KBMS    | p. 33 PS/2 Keyboard Port (6 pin female)                       |
| 3) USB        | p. 34 Universal Serial Bus Ports 1 & 2 (Two 4 pin female)     |
| 4) PRINTER    | p. 34 Parallel Port (25 pin female)                           |
| 5) COM1/COM2  | p. 35 Serial Ports (9 pin /10-1 pin male)                     |
| 6) GAME_AUDIO | p. 35 Game/MIDI Port (15-pin female) ( <i>optional</i> )      |
| 7) AUDIO      | p. 35 Audio Connectors (Three 1/8" AUDIO) ( <i>optional</i> ) |
| 8) IDELED     | p. 36 IDE Activity LED (2 pin)                                |
| 9) FLOPPY     | p. 36 Floppy Disk Drive Connector (34 pin)                    |

# 3. HARDWARE SETUP

---

10) PRIMARY IDE	p. 37 IDE Connectors (Two 40-1 pin)
SECONDARY IDE	
11) CPU/PWR/CHA_FAN	p. 38 CPU, Power, and Chassis Fan Connectors (Three 3 pin)
12) USB2_3 / USB4_5	p. 38 USB Headers (10-1 pin)
13) IR_CON	p. 39 Standard Infrared Module Connector (10-1 pin)
14) AFPANEL	p. 39 ASUS iPanel Connector (12-1 pin)
15) ATXPWR	p. 40 ATX Power Supply Connector (20 pin)
16) SMB	p. 40 SMBus Connector (5-1 pin)
17) CD/AUX/MODEM	p. 41 Internal Audio Connectors (Three 4-1 pin) ( <i>optional</i> )
18) MIC2	p. 41 Internal Microphone Connector (3 pin) ( <i>optional</i> )
19) HPHONE	p. 42 Headphone Line Out connector (3 pin) ( <i>optional</i> )
20) JTPWR	p. 42 Power Supply Thermal Sensor (2 pin)
21) SPDIFOUT / CDSPDIFIN	p. 43 Digital audio Interfaces (2 pin) ( <i>optional</i> )
22) CHASSIS	p. 43 Chassis Intrusion Lead (2 pin)
23) AAPANEL	p. 44 ASUS iPanel Audio Connector (10-1 pin)
24) SMARTCON	p. 44 ASUS SmartCard Connector (14-1 pin)
25) PWR.LED (PANEL)	p. 45 System Power LED Lead (3 pin)
26) KEYLOCK (PANEL)	p. 45 System Keyboard Lock Switch Lead (2 pin)
27) SPEAKER (PANEL)	p. 45 System Warning Speaker Lead (4 pin)
28) MSG.LED (PANEL)	p. 45 System Message LED Lead (2 pin)
29) SMI (PANEL)	p. 45 System Management Interrupt Lead (2 pin)
30) PWR.SW (PANEL)	p. 45 ATX / Soft-Off Switch Lead (2 pin)
31) RESET (PANEL)	p. 45 Reset Switch Lead (2 pin)



# 3. HARDWARE SETUP

## 3.3 Hardware Setup Procedure

Complete the following steps before using your computer:

1. Check motherboard settings
2. Install memory modules
3. Install the Central Processing Unit (CPU)
4. Install Expansion Cards
5. Connect ribbon cables, panel wires, and power supply cables
6. Configure the BIOS parameter settings

## 3.4 Motherboard Settings

This section tells you how to change motherboard function settings through the switches and/or jumpers.

**WARNING!** Computer motherboards and expansion cards contain very delicate Integrated Circuit (IC) chips. To avoid damaging them due to static electricity, follow these precautions whenever you work on your computer.

1. Unplug the computer when working on the internal components.
2. Use a grounded wrist strap or touch a safely grounded object or to a metal object, such as the power supply case, before handling computer components.
3. Hold components by the edges and try not to touch the IC chips on them.
4. Whenever you uninstall any component, place the components on a grounded antistatic pad or in the bag that came with the components.
5. **Before you install or remove any component, ensure that the ATX power supply is switched off or the power cord is detached from the power supply.** Failure to do so may cause severe damage to the motherboard, peripherals, and/or components.

(**TIP:** When lit, the onboard LED indicates that the system is in suspend or soft-off mode, not powered OFF. See illustration below.)

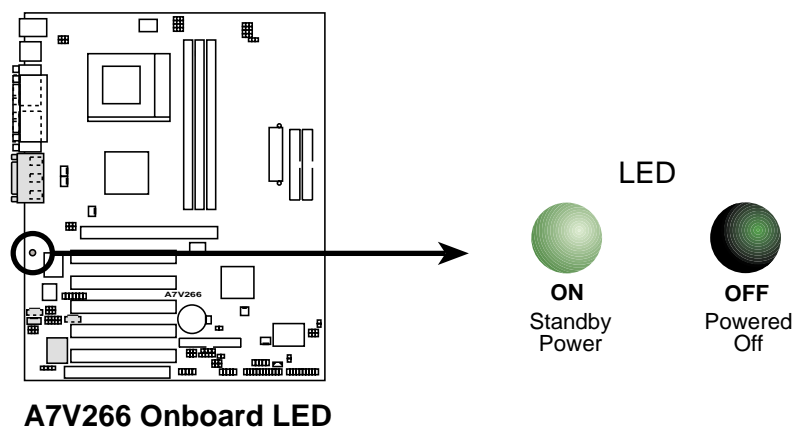

# 3. HARDWARE SETUP

## Motherboard Frequency Settings (DIP Switches)

The motherboard frequency is adjusted through the DIP switches. The white block represents the switch's position. The illustration below shows all the switches in the OFF position.

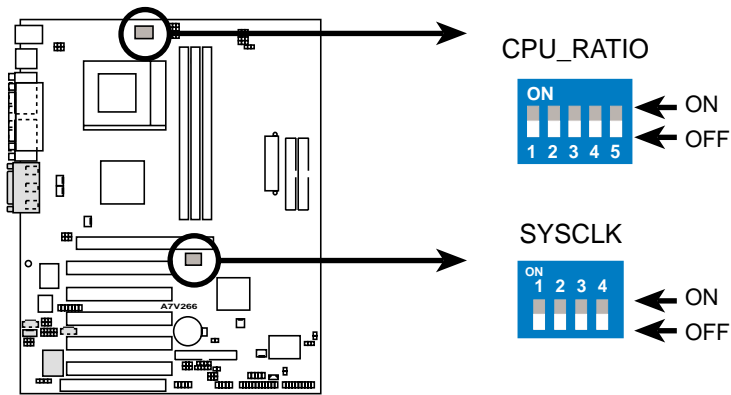

**A7V266 DIP Switch**

### 1) JumperFree™ Mode (JEN)

This jumper allows you to enable or disable the JumperFree™ mode. The JumperFree™ mode allows processor settings to be made through the BIOS setup (see *4.4 Advanced Menu*).

Setting	JEN
Enable (JumperFree)	[2-3] (default)
Disable (Jumper Mode)	[1-2]

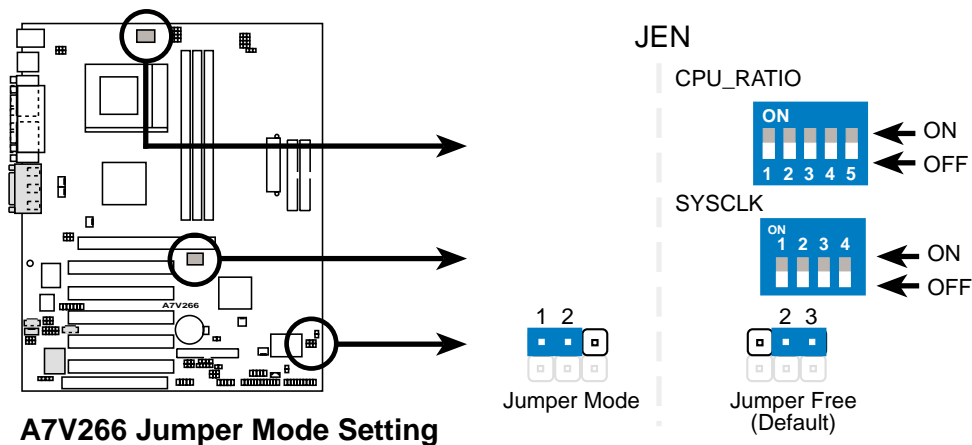

**A7V266 Jumper Mode Setting**

**NOTE:** In JumperFree™ mode, set all DIP switches (DIP\_SW) to OFF.

# 3. HARDWARE SETUP

## 2) CPU External Frequency Selection (DIP\_SW Switches 1-4)

This option tells the clock generator what frequency to send to the CPU, DRAM, and the PCI bus. This allows the selection of the CPU's *External* frequency (or *BUS Clock*). The BUS Clock multiplied by the Frequency Multiple equals the CPU's *Internal* frequency (the advertised CPU speed).

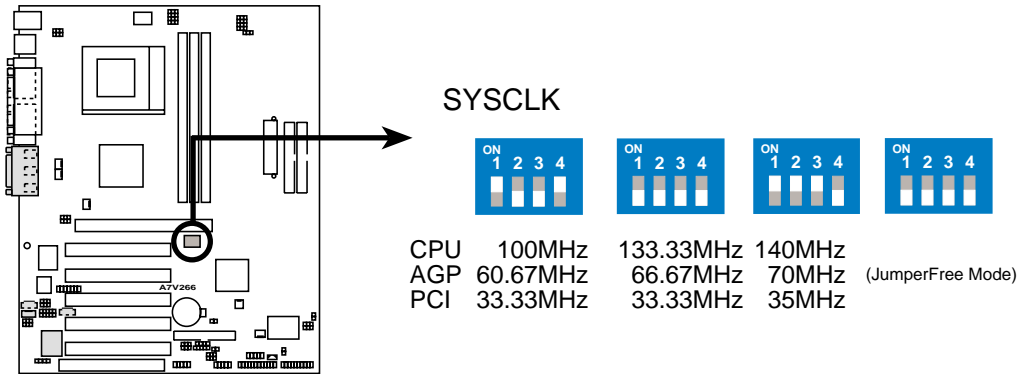

**A7V266 CPU External Frequency Selection**

**WARNING!** Set the CPU frequency only to the recommended settings. Frequencies other than the recommended CPU bus frequencies are not guaranteed to be stable. Overclocking the processor is not recommended. It may result in a slower speed.

## 3) Manual CPU Ratio Settings (DSW Switches 5-10)

Set DSW switches (5-10) to use the clock multiplier to coordinate the ratio of bus speeds with CPU settings. Set the DSW switches according to the internal speed of your processor and the bus frequency (133/100MHz).

**IMPORTANT:**

- To use this feature, JEN must be set to Jumper Mode, [1-2]. (See 1, *JumperFree™ Mode (JEN)* in 3, *HARDWARE SETUP*.)
- When JumperFree mode is enabled, use BIOS setup in place of these switches. (Set *Operating Frequency Setting* to *User Define* under 4.4 *Advanced Menu* in BIOS Setup so you can set the *CPU Frequency*.)

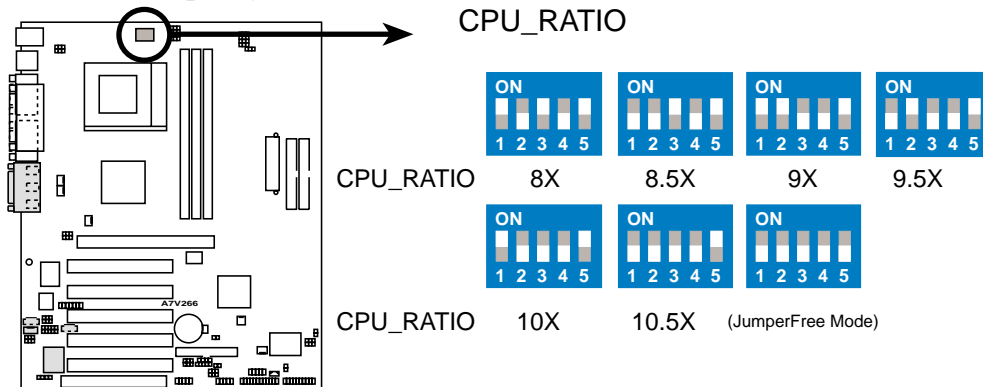

**A7V266 CPU External Clock (BUS) Frequency Selection**

# 3. HARDWARE SETUP

## 4) CPU Type Frequency Setting (PALO\_FREQ)

This jumper setting accommodates the difference between the internal frequency between standard and new AMD CPUs. If changing from one type of CPU to another, the jumper caps must be adjusted. The factory default setting, [2-3], is for standard *Athlon/Duron* CPUs. The *Palomino* processor will only function on this motherboard after the jumpers are adjusted to [1-2].

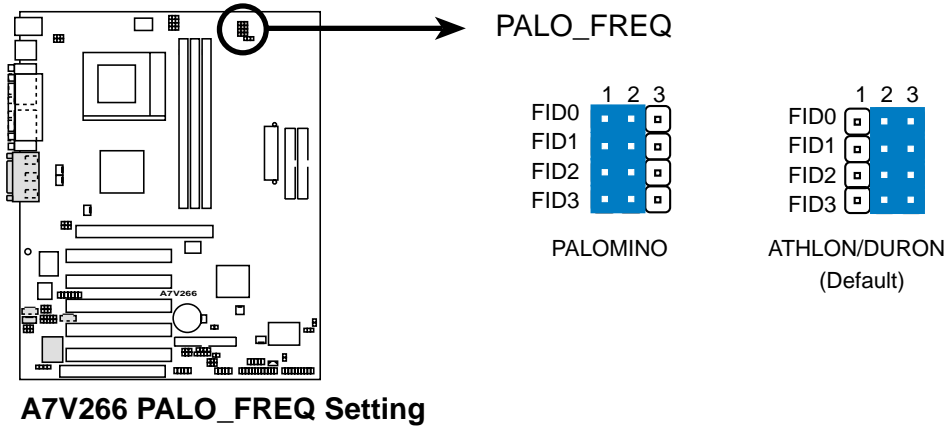

## 5) I/O Voltage Settings (JP1, JP2)

These jumpers allow you to select the voltage supplied to the DRAM, chipset, AGP, and PCI. The default setting for the jumpers is: JP1 [2-3] and JP2 [1-2], 2.65 volts. Use the default setting for better system reliability.

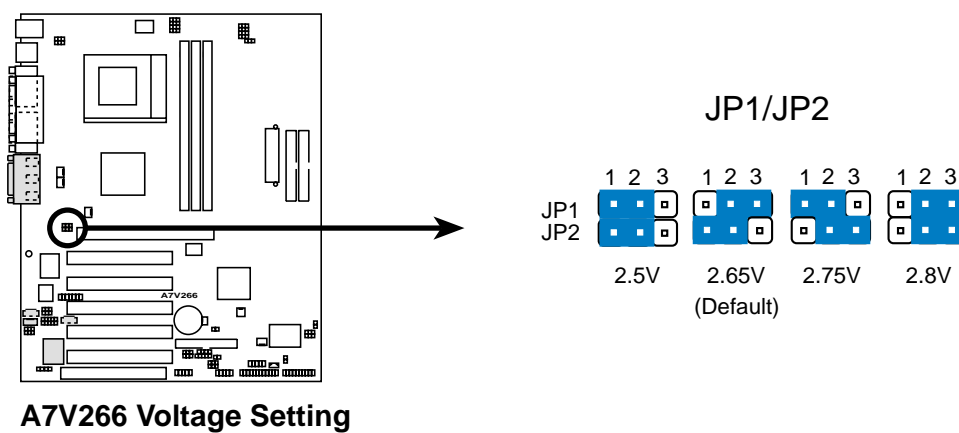

# 3. HARDWARE SETUP

## 6) Voltage Regulator Output Setting (VID1, VID2, VID3, VID4)

This jumpers allow you to manually adjust the CPU core voltage. It is recommended to use **CPU Default** as the CPU core voltage. **CPU Default** means the Vcore is generated according to the CPU VID configuration. For each jumper setting, there are two voltage options, depending on the CPU used.

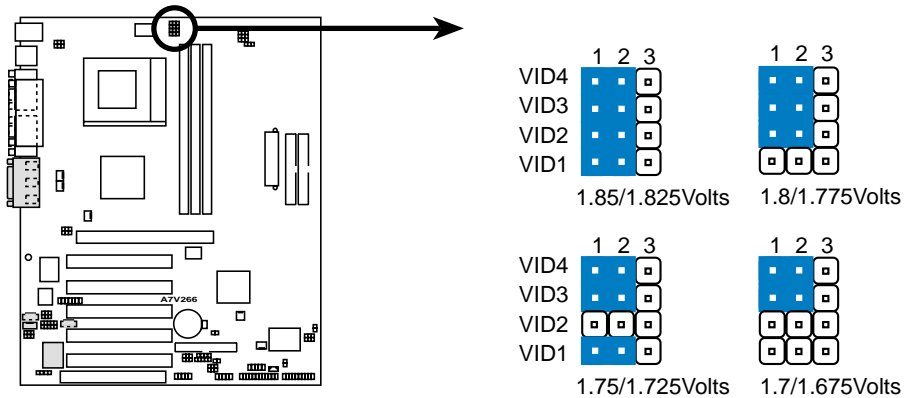

**A7V266 CPU Core Voltage Selection**

## 7) Bass Center Setting (CENTER/BASS, BASS/CENTER)

Use these jumpers in conjunction with the C-Media PCI Audio Driver and to adjust output for 4 or 6 speaker audio. No audio standard exists for the three pick-up surfaces on male audio jacks, therefore it may be necessary to switch jumpers from the default position, type 1, to type 2, in order to help reroute signals among the internal leads in the Line-In, Line-Out, Mic female sockets. Make sure a test is made using the C-Media Audio Driver software setup available on the Support CD.

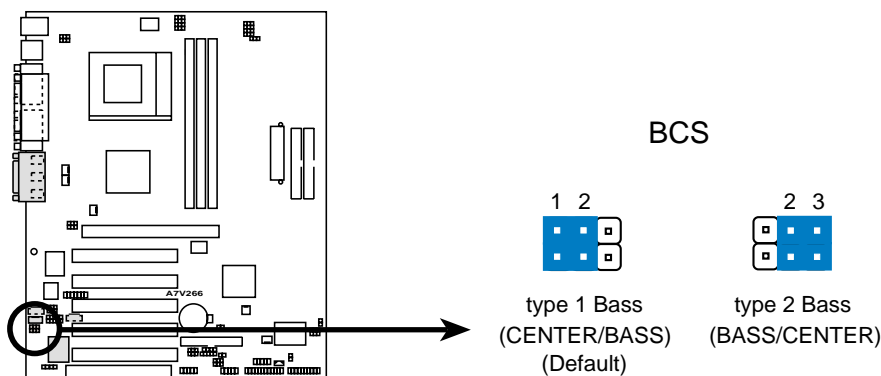

**A7V266 Bass Center Setting**

# 3. HARDWARE SETUP

## 8) Keyboard Wake Up (KBWK)

This allows you to disable or enable the keyboard power up function. Set this jumper to *Enable* if you wish to use your keyboard (by pressing <Spacebar>) to power up your computer. This feature requires an ATX power supply that can supply at least 300mA on the +5VSB lead. The default is set to *Enable*. (The computer will not power ON if you set this to *Enable* but do not have the correct ATX power supply. **NOTE:** This jumper must be set in conjunction with **Wake On PS2 KB/PS2 Mouse/CIR** in **4.5.1 Power Up Control**.)

<u>Setting</u>	<u>KBWK</u>
Enable	[1-2] (default)
Disable	[2-3]

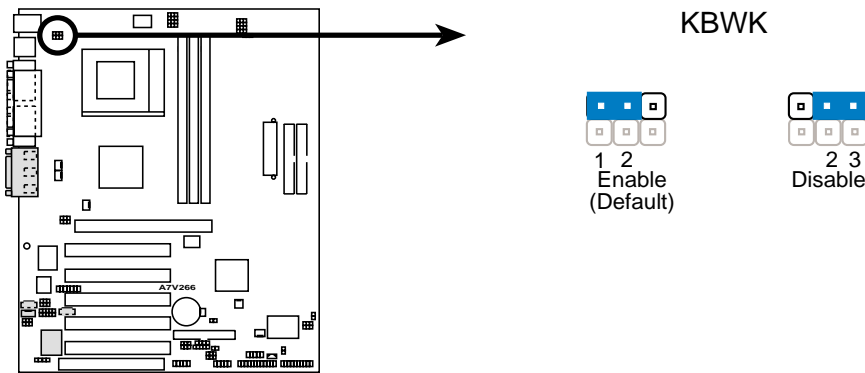

**A7V266 Keyboard Wake Up**

## 9) ACR/USB Selection (ACRUSB1, ACRUSB2) (audio models only)

When set to pins 1-2, these jumpers allow you to activate USB port 3. Setting the jumpers to pins 2-3 activates the Advanced Communication Riser (ACR) slot. The default setting for both jumpers is 1-2. (NOTE: The USB port 2 is always active regardless of the setting of these jumpers.)

**IMPORTANT!** Always set both jumpers accordingly when selecting a device.

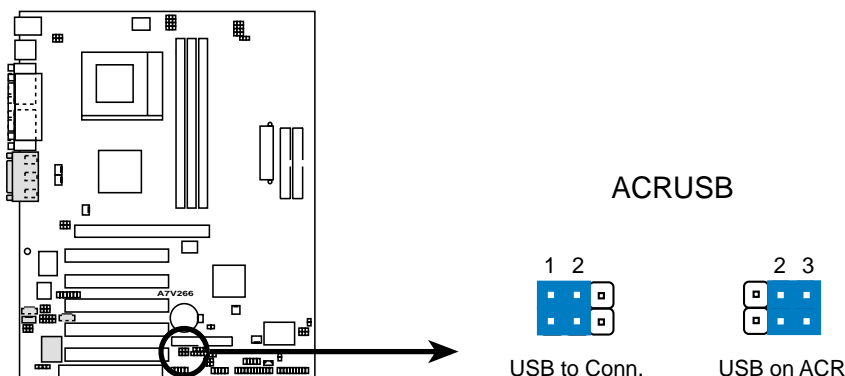

**A7V266 USB/ACR Selection**

# 3. HARDWARE SETUP

## 10) USB Device Wake-up (USB01\_PWR/USB23\_PWR/USB45\_PWR)

Set these jumpers to +5V to allow wake up from the S1 sleep state (CPU stopped; RAM refreshed; system running in low power mode) using the connected USB devices. Set to +5VSB to allow wake up from S3 sleep state (no power to CPU; RAM in slow refresh; power supply in reduced power mode). The default setting for the three jumpers is 1-2 to select +5V (because not all computers have the appropriate power supply).

### NOTES:

1. This feature requires an ATX power supply that can supply at least 2A on the +5VSB lead when these jumpers are set to +5VSB. Otherwise, the system does not power up.
2. The total current consumed must NOT exceed the power supply capability (+5VSB) whether under normal working conditions or in sleep mode.

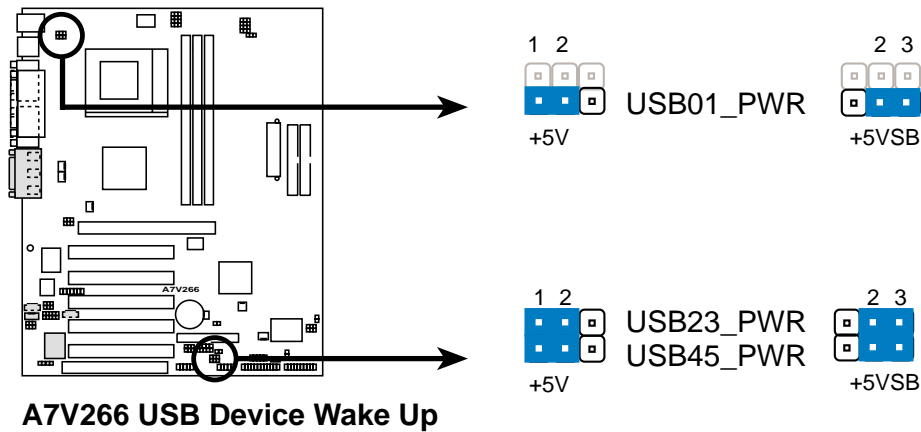

# 3. HARDWARE SETUP

## 11) Clear RTC RAM (2-pin CLR\_RTC)

This jumper allows you to clear the Real Time Clock (RTC) RAM in CMOS. You can clear the CMOS memory of date, time, and system setup parameters by erasing the CMOS RTC RAM data. The RAM data in CMOS, that include system setup information such as system passwords, is powered by the onboard button cell battery.

To erase the RTC RAM:

1. Turn OFF the computer and unplug the power cord.
2. Remove the battery.
3. Short the jumper by removing and replacing the jumper cap.
4. Re-install the battery.
5. Plug the power cord and turn ON the computer.
6. Hold down the <Del> key during the boot process and enter BIOS setup to re-enter data.

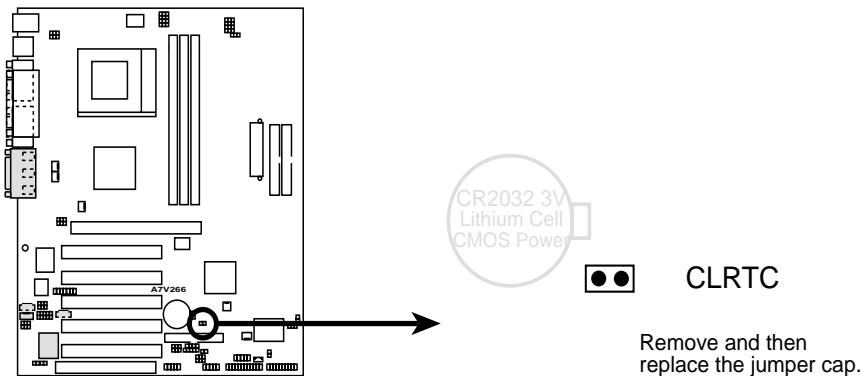

**A7V266 Clear RTC RAM**

## 12) Thermal Sensor CPU Setting (2-pin THEMCPU)

This jumper selects the type of CPU and coordinates its thermal sensory capability. The default setting, [1-2], is for Athlon/Duron and, [2-3], is for Reserve type processors.

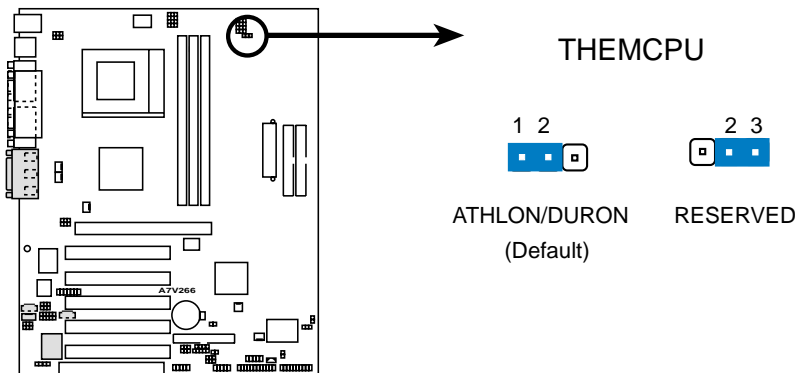

**A7V266 THEMCPU Setting**



# 3. HARDWARE SETUP

## 3.5 System Memory

This motherboard features three Double Data Rate (DDR) Dual Inline Memory Module sockets.

### 3.5.1 DDR DIMM Support

The two DDR DIMM sockets support **2.5Volt** (power level) unbuffered/registered Double Data Rate Synchronous Dynamic Random Access Memory (DDR SDRAM) of 64MB, 128MB, 256MB, 512MB, and 1GB to form a memory size between 64MB to 3GB. One side (with memory chips) of the DIMM takes up one row on the motherboard.

DDR DIMMs support non-ECC memory (used on desktops/laptops).

*Install memory in any combination as follows:*

DIMM Location	184-pin DDR DIMM	Total Memory
Socket 1 (Rows 0&1)	64MB, 128MB, 256MB, 512MB, 1GB	x1
Socket 2 (Rows 2&3)	64MB, 128MB, 256MB, 512MB, 1GB	x1
Socket 3 (Rows 4&5)	64MB, 128MB, 256MB, 512MB, 1GB	x1
<b>Total System Memory (Max 3GB)</b>		<b>=</b>

# 3. HARDWARE SETUP

## 3.5.1 General DIMM Notes

- **DIMMs that have more than 18 chips are not supported on this motherboard.**
- ASUS motherboards support SPD (Serial Presence Detect) DIMMs. This is the memory of choice for best performance vs. stability.
- BIOS shows SDRAM memory on bootup screen.
- Single-sided DDR DIMMs come in 64, 128, and 256MB; double-sided come in 128, 256, and 512MB.

**WARNING!** Be sure that the DIMMs you use can handle the specified DDR RAM MHz or else bootup will not be possible.

## 3.5.2 Memory Installation

**WARNING!** Make sure that you unplug your power supply when adding or removing memory modules or other system components. Failure to do so may cause severe damage to both your motherboard and expansion cards (see **3.3 Hardware Setup Procedure** for more information).

Insert the module(s) as shown. Because the number of pins are different on either side of the breaks, the module will only fit in the orientation shown. A 184-pin DDR DRAM DIMM has a single notch slightly to the right of center.

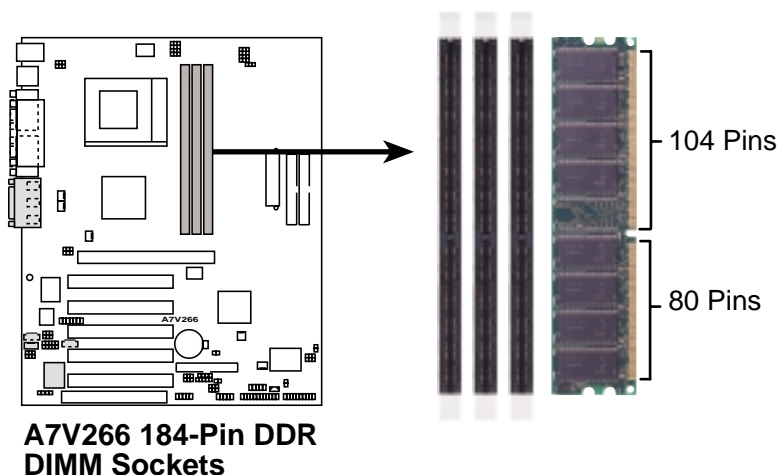

This motherboard supports three pairs of differential clock signals per DIMM.

# 3. HARDWARE SETUP

## 3.6 Central Processing Unit (CPU)

The motherboard provides a Socket 462 or Socket A for CPU installation. A fan and heatsink should be attached to the CPU to prevent overheating. Purchase and install a fan and heatsink before turning on the system.

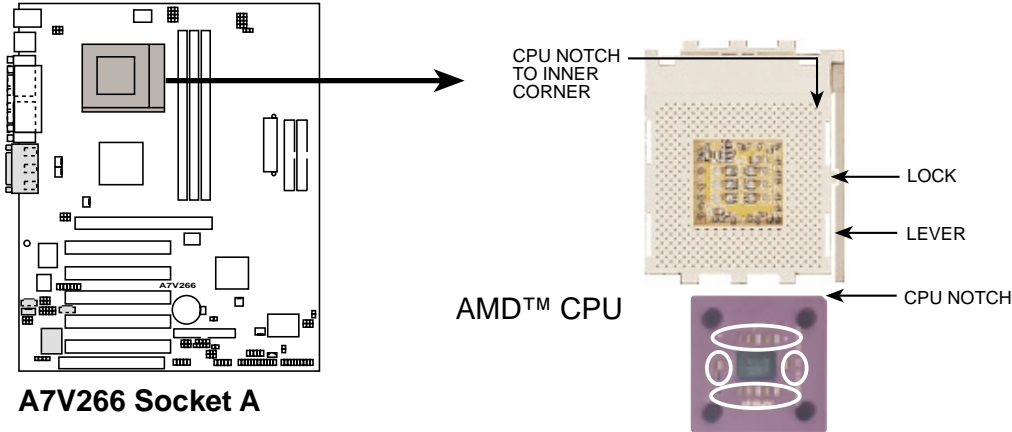

1. Locate the Socket 462 and open it by pulling the lever gently sideways away from the socket. Then lift the lever upwards. The socket lever must be fully opened (90 to 100 degrees).
2. Insert the CPU with the correct orientation. The *notched corner* of the CPU must be oriented toward the inner corner of the socket base nearest to the lever hinge.

**CAUTION!** The CPU fits in one orientation and should drop easily into place. *Do not force the CPU* into the socket to avoid bending the pins. If the CPU does not fit, check its alignment and look for bent pins.

3. Once completely inserted, press the CPU firmly and close the socket lever until it snaps into its locked position.
4. Place the CPU fan and heatsink on the CPU. The heatsink should entirely cover the CPU. Carefully attach the heatsink locking brace to the plastic clips on the socket base. With the added weight of the CPU fan and heatsink locking brace, no extra force is required to keep the CPU in place.

**CAUTION!** Take care not to scrape the motherboard surface when mounting a clamp-style processor fan, or else damage may occur. When mounting a heatsink onto your CPU, make sure that exposed CPU capacitors do not touch the heatsink, or else damage may occur! Refer to heatsink/CPU documentation.

**NOTE!** Do not forget to set the correct Bus Frequency and Multiple (available only on unlocked processors) to avoid start-up problems.

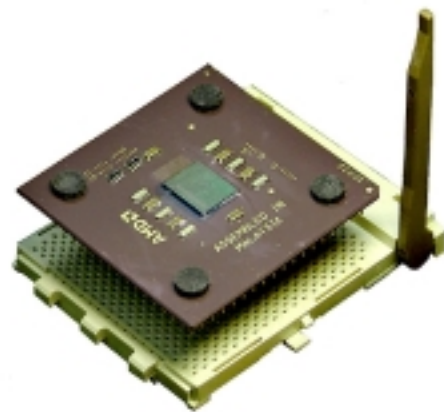

# 3. HARDWARE SETUP

## 3.7 Expansion Cards

In the future, you may need to install expansion cards. The motherboard has five PCI expansion slots to support these cards. Follow the steps in the next section when installing expansion cards.

**WARNING!** Unplug the system power cord when adding or removing expansion cards or other system components. Failure to do so may cause severe damage to both the motherboard and expansion cards.

### 3.7.1 Installing an Expansion Card

1. Read the documentation that comes with the expansion card and make any necessary hardware settings for the card before installing it.
2. Remove the system unit cover and the bracket plate on the slot you intend to use. Keep the screw for later use.
3. Align the card connectors with the slot and press firmly until the card fits in place.
4. Secure the card to the slot with the screw you removed earlier.
5. Replace the system cover.
6. Change the necessary BIOS settings, if any.  
(see section **4.4.3 PCI Configuration** to change the settings.)
7. Install the necessary software drivers for the expansion card.

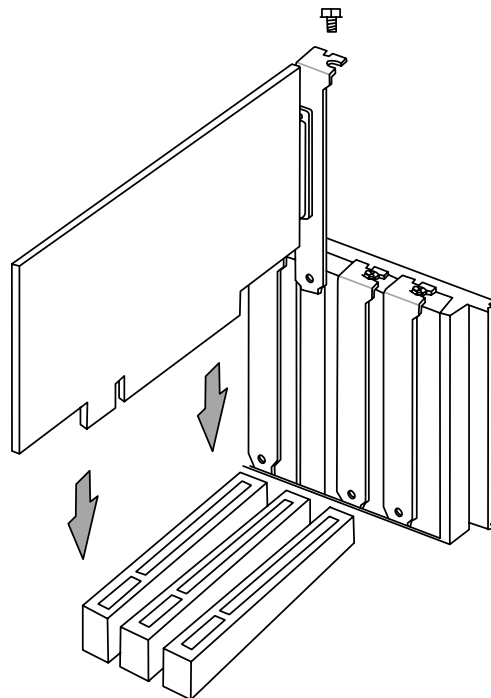

# 3. HARDWARE SETUP

## 3.7.2 Assigning IRQs for Expansion Cards

Some expansion cards need an IRQ to operate. Generally, an IRQ must be exclusively assigned to one use. In a standard design, there are 16 IRQs available but most of them are already in use, leaving 6 IRQs free for expansion cards. If your motherboard has **PCI** audio onboard, an additional IRQ will be used. If your motherboard also has **MIDI** enabled, another IRQ will be used, leaving 4 IRQs free.

**IMPORTANT:** If using PCI cards on shared slots, make sure that the drivers support “Share IRQ” or that the cards do not need IRQ assignments. Conflicts arise between the two PCI groups that will make the system unstable or cards inoperable.

The following table lists the default IRQ assignments for standard PC devices. Use this table when configuring your system and for resolving IRQ conflicts.

### *Standard Interrupt Assignments*

IRQ	Priority	Standard Function
0	1	System Timer
1	2	Keyboard Controller
2	N/A	Programmable Interrupt
3*	11	Communications Port (COM2)
4*	12	Communications Port (COM1)
5*	13	Sound Card (sometimes LPT2)
6	14	Floppy Disk Controller
7*	15	Printer Port (LPT1)
8	3	System CMOS/Real Time Clock
9*	4	ACPI Mode when used
10*	5	IRQ Holder for PCI Steering
11*	6	IRQ Holder for PCI Steering
12*	7	PS/2 Compatible Mouse Port
13	8	Numeric Data Processor
14*	9	Primary IDE Channel
15*	10	Secondary IDE Channel

\*These IRQs are usually available for ISA or PCI devices.

### *Interrupt Request Table for this Motherboard*

	INT-A	INT-B	INT-C	INT-D
PCI slot 1	—	—	—	shared
PCI slot 2	shared	—	—	—
PCI slot 3	—	shared	—	—
PCI slot 4	—	—	used	—
PCI slot 5	—	—	—	shared
AGPPro slot	shared	shared	—	—
ACR slot	shared	—	—	—
Onboard audio controller	—	shared	—	—
Onboard USB controller	—	—	—	shared

# 3. HARDWARE SETUP

## 3.7.3 Accelerated Graphics Port (AGP) Pro Slot

This motherboard has an Accelerated Graphics Port (AGP) Pro slot to support the new generation graphics cards with ultra-high memory bandwidth.

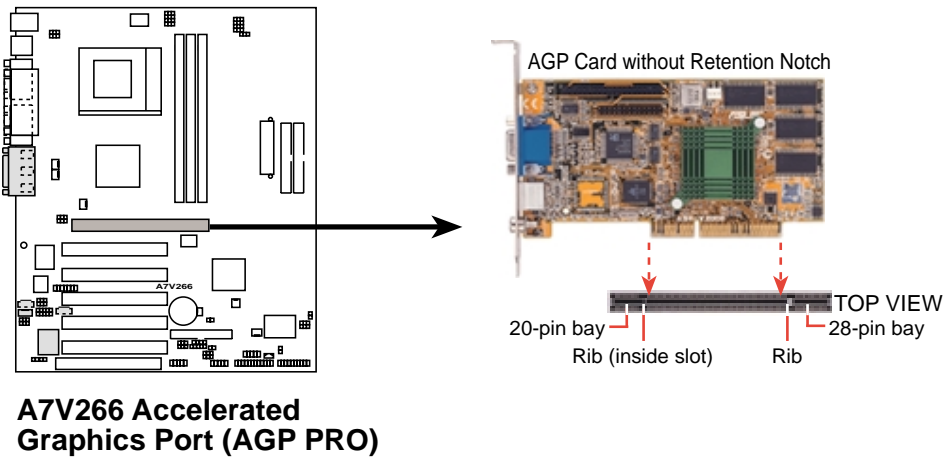

**A7V266 Accelerated Graphics Port (AGP PRO)**

**CAUTION!** The AGP Pro slot is shipped with a warning label over the 20-pin bay. DO NOT remove this label and the safety tab underneath it if you are using an AGP card *without* a retention notch. Removing may cause the card to shift and may cause damage to the card, slot, and motherboard. Remove the label and tab **ONLY** if you are using an *AGP Pro* card. Use a rigid tip, such as a pen tip, to dislodge

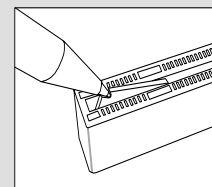

Removing the tab

## 3.7.4 Advanced Communication Riser (ACR) Slot

This motherboard has an Advanced Communication Riser (ACR) slot for communications and audio subsystems. The slot supports modem, audio, LAN, and Home Phoneline Networking Alliance (HPNA) or Home Networking cards. The ACR slot is backward compatible with the Audio Modem Riser (AMR) cards.

**IMPORTANT!** The ACR slot on the motherboard shares the same expansion slot with PCI Slot 5.

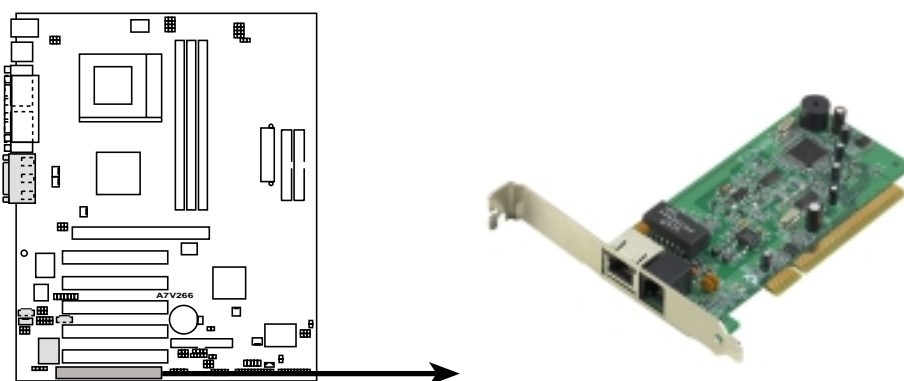

**A7V266 Advanced Communication Riser (ACR)**

# 3. HARDWARE SETUP

## 3.8 Connectors

### 3.8.1 External Connectors

**WARNING!** Some pins are used for connectors or power sources. These are clearly distinguished from jumpers in the Motherboard Layout. Placing jumper caps over these connector pins will cause damage to your motherboard.

**IMPORTANT:** Ribbon cables should always be connected with the red stripe to Pin 1 on the connectors. Pin 1 is usually on the side closest to the power connector on hard drives and CD-ROM drives, but may be on the opposite side on floppy disk drives. Check the connectors before installation because there may be exceptions. IDE ribbon cable must be less than 46 cm (18 in.), with the second drive connector no more than 15 cm (6 in.) from the first connector.

#### 1) PS/2 Mouse Port (Green 6-pin PS2KBMS)

The system automatically directs IRQ12 to the PS/2 mouse if one is detected. If no mouse is detected, IRQ12 become available to expansion cards. See **PS/2 Mouse Function Control** in *4.4 Advanced Menu*.

PS/2 Mouse (6-pin Female)

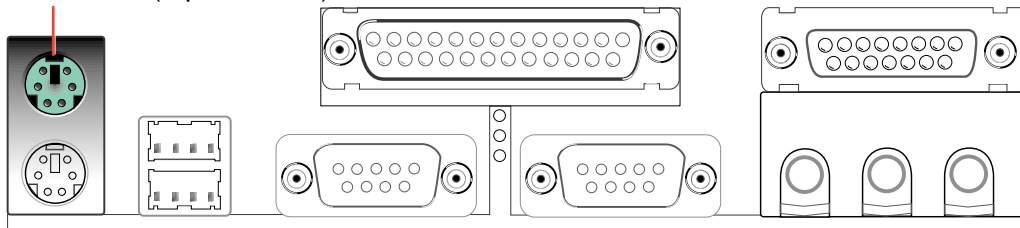

#### 2) PS/2 Keyboard Port (Purple 6-pin PS2KBMS)

This connection is for a standard keyboard using an PS/2 plug (mini DIN). **This connector does not allow standard AT size (large DIN) keyboard plugs. You may use a DIN to mini DIN adapter on standard AT keyboards.**

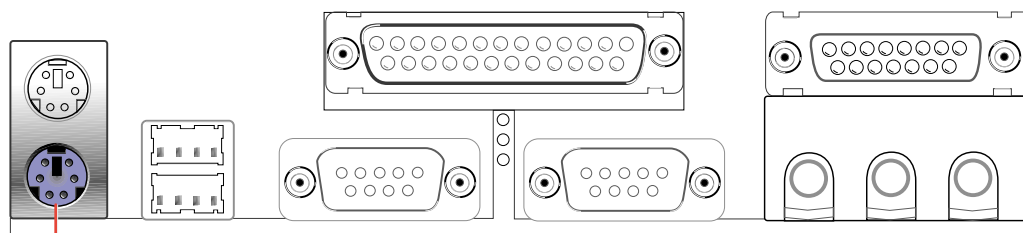

PS/2 Keyboard (6-pin Female)

# 3. HARDWARE SETUP

## 3) Universal Serial Bus Ports 1 & 2 (Black two 4-pin USB)

Two USB ports are available for connecting USB devices.

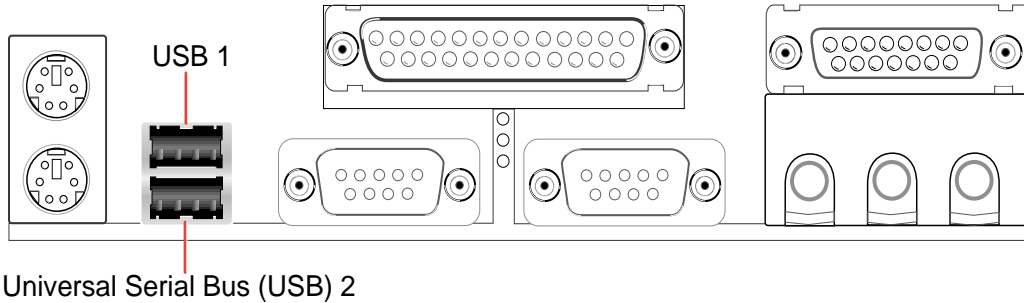

## 4) Parallel Port (Burgundy 25-pin PRINTER)

You can enable the parallel port and choose the IRQ through **Onboard Parallel Port** (see **4.4.2 I/O Device Configuration**).

**NOTE:** Serial printers must be connected to the serial port.

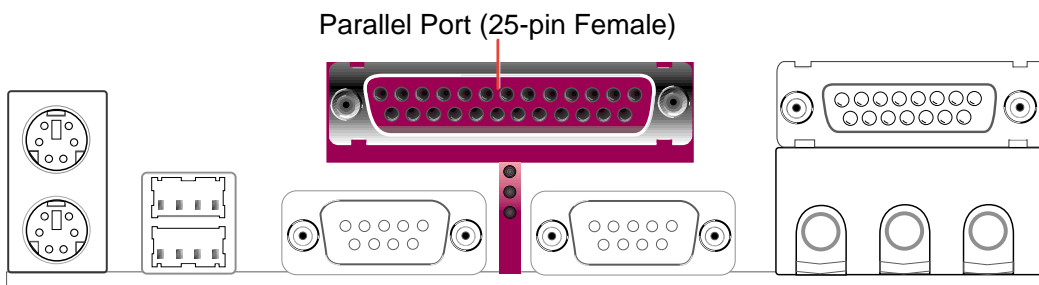

## 5) Serial Ports (Teal/Turquoise 9-pin COM1 / 9-pin COM2)

Two serial ports can be used for pointing devices or other serial devices. To enable these ports, see **Onboard Serial Port 1 / Onboard Serial Port 2** in **4.4.2 I/O Device Configuration** for the settings.

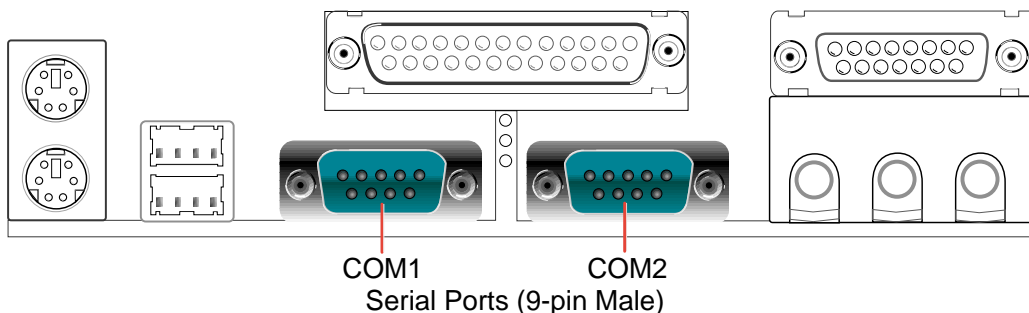



# 3. HARDWARE SETUP

## 6) Game/MIDI Ports (Gold 15-pin GAME\_AUDIO) (optional)

This connector supports a joystick or a game pad for playing games, and MIDI devices for playing or editing audio files.

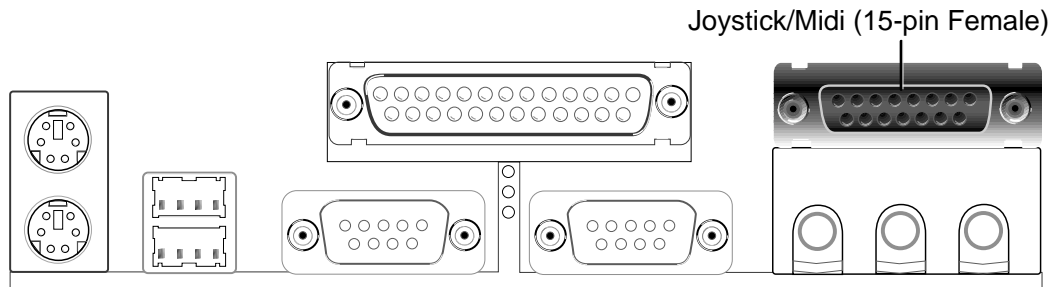

## 7) Audio Connectors (Three 1/8" AUDIO) (optional)

The **Line Out** (lime) connects a headphone or speakers. The **Line In** (light blue) connects a tape players or other audio sources. The **Mic** (pink) connects a microphone.

**NOTE:** The functions of the audio connectors Line Out, Line In, and Mic change when the 6-channel audio feature is enabled. Refer to **Chapter 5. SOFTWARE SETUP.**

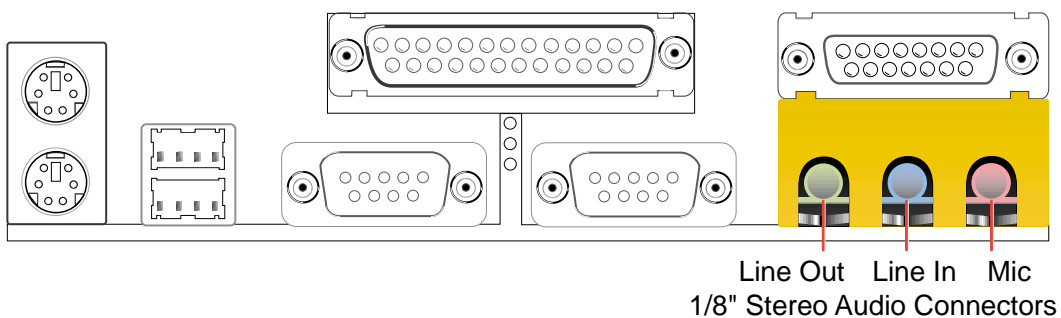

# 3. HARDWARE SETUP

## 8) IDE Activity LED (2-pin IDELED)

This connector supplies power to the cabinet's IDE activity LED. Read and write activity by devices connected to the Primary or Secondary IDE connectors cause the IDE LED to light up.

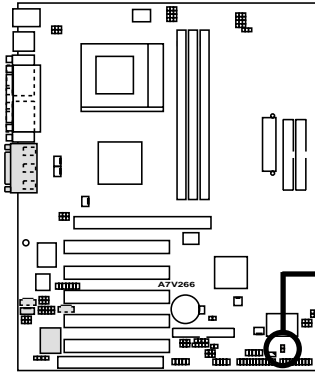

**A7V266 IDE Activity LED**

IDELED



**TIP:** If the case-mounted LED does not light, try reversing the 2-pin plug.

## 9) Floppy Disk Drive Connector (34-1 pin FLOPPY)

This connector supports the provided floppy drive ribbon cable. After connecting the single end to the board, connect the two plugs on the other end to the floppy drives. **(Pin 5 is removed to prevent inserting in the wrong orientation when using ribbon cables with pin 5 plugged).**

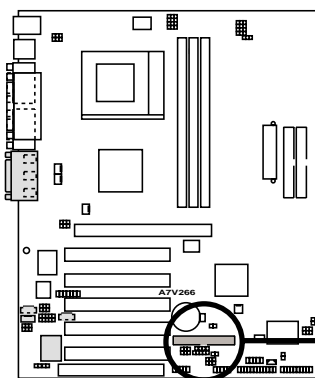

**A7V266 Floppy Disk Drive Connector**

**NOTE:** Orient the red markings on the floppy ribbon cable to PIN 1

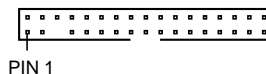

# 3. HARDWARE SETUP

## 10) Primary (Blue) / Secondary IDE Connectors (40-1 pin IDE1/IDE2)

These connectors support the UltraDMA/100/66 IDE hard disk ribbon cable supplied with the motherboard. Connect the cable's blue connector to the primary (recommended) or secondary IDE connector, then connect the gray connector to the UltraDMA/100/66 slave device (hard disk drive) and the black connector to the UltraDMA/100/66 master device. It is recommended that non-UltraDMA/100/66 devices be connected to the secondary IDE connector. If you install two hard disks, you must configure the second drive as a slave device by setting its jumper accordingly. Refer to the hard disk documentation for the jumper settings. BIOS supports specific device bootup (see **4.6. Boot Menu**). If you have more than two UltraDMA/100/66 devices, purchase another UltraDMA/100/66 cable.

### NOTES:

1. Pin 20 on each IDE connector is removed to match the covered hole on the UltraDMA cable connector. This prevents incorrect orientation when you connect the cables.
2. The hole near the blue connector on the UltraDMA/100/66 cable is intentional.

**TIP:** You may configure two hard disks to be both Masters with two ribbon cables: one for the primary IDE connector and another for the secondary IDE connector.

**IMPORTANT:** For UltraDMA/100/66 IDE devices, use a 40-pin 80-conductor IDE cable. The UltraDMA/66 cable included in the motherboard package also supports UltraDMA/100.

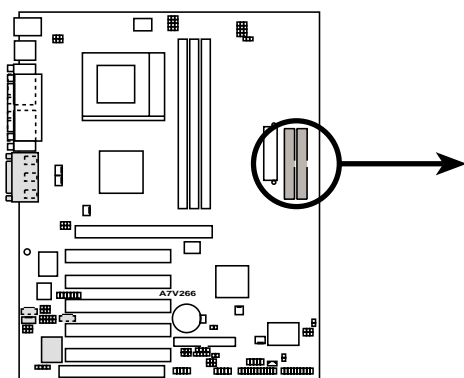

**A7V266 IDE Connectors**

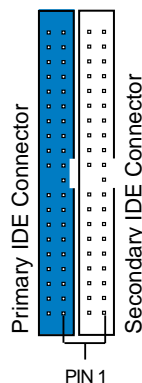

**NOTE:** Orient the red markings (usually zigzag) on the IDE ribbon cable to PIN 1.

# 3. HARDWARE SETUP

## 11) CPU Fan, Power Fan, and Chassis Fan Connectors

(CPU\_FAN, PWR\_FAN, CHA\_FAN)

The three fan connectors support cooling fans of 350mA (4.2 Watts) or less. Orient the fans so that the heat sink fins allow airflow to go across the onboard heat sinks instead of the expansion slots. The fan wiring and plug may vary depending on the fan manufacturer. Connect the fan cable to the connector making sure that the black wire matches the ground pin. (**NOTE:** Use the “Rotation” signal only with a specially designed fan with a rotation signal. You can monitor the Rotations Per Minute (RPM) using ASUS PC Probe (see **6. SOFTWARE REFERENCE**).

**WARNING!** Make sure to connect the fan cables to the fan connectors. Lack of sufficient airflow within the system could cause damage to the motherboard. **These are not jumpers, do not place jumper caps over these connectors!**

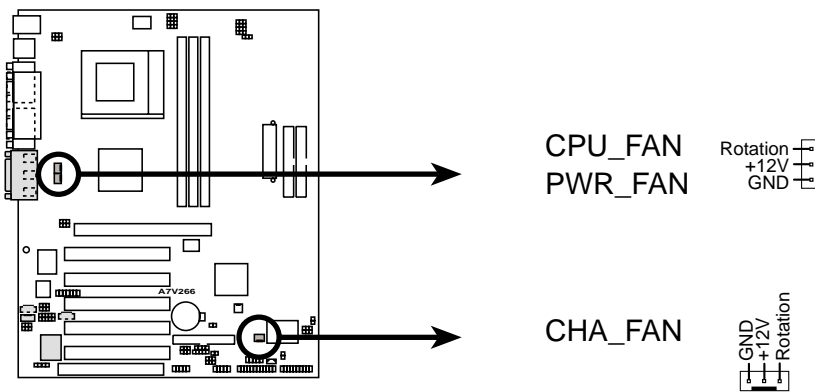

A7V266 12-Volt Cooling Fan Power

## 12) USB Headers (10-1 pin USB2\_3, USB4\_5)

If the USB port connectors on the back panel are inadequate, two USB headers are available for four additional USB port connectors. Connect a 2-port USB connector set to a USB header and mount the USB bracket to an open slot in the chassis. (The USB connector set is optional and does not come with the motherboard package.)

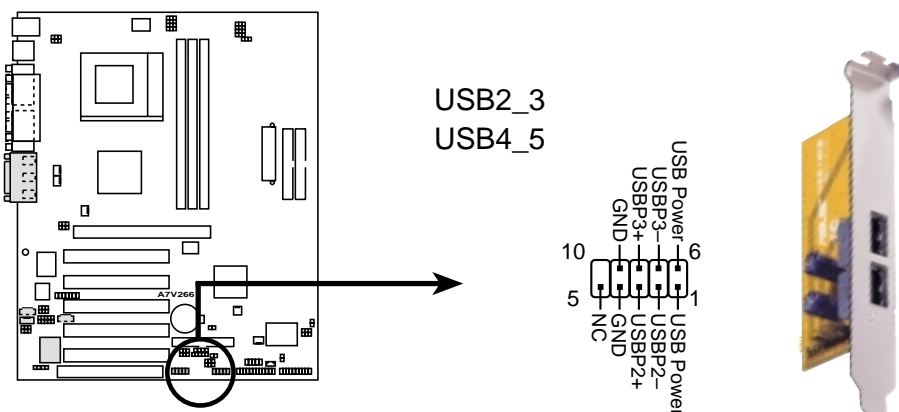

A7V266 Front Panel USB Headers

# 3. HARDWARE SETUP

## 13) Infrared Module Connector (10-1 pin IR\_CON)

This connector supports an optional wireless transmitting and receiving infrared module. This module mounts to a small opening on system cases that support this feature. You must also configure the setting through **UART2 Use Infrared** (see **4.4.2 I/O Device Configuration**) to select whether UART2 is directed for use with COM2 or IrDA. Use the five pins as shown in Back View and connect a ribbon cable from the module to the motherboard SIR connector according to the pin definitions. (NOTE: The SIR module does not come with the motherboard package. The CIR module is currently not available.)

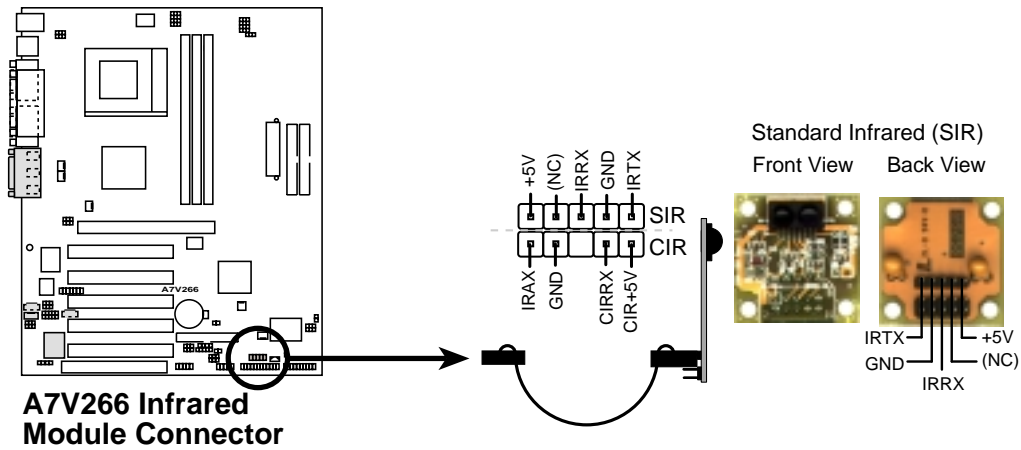

## 14) ASUS iPanel Connector (24-1 pin AFPANEL)

This connector allows you to install an optional ASUS iPanel, an easy to access drive bay with front I/O ports, status LEDs, and space reserved for a hard disk drive. If you are not using an ASUS iPanel, you can connect an optional wireless transmitting and receiving infrared module to the SIR connector or an optional consumer infrared connector set to the CIR and SIR connectors for both wireless transmitting and remote control functions through one external infrared module.

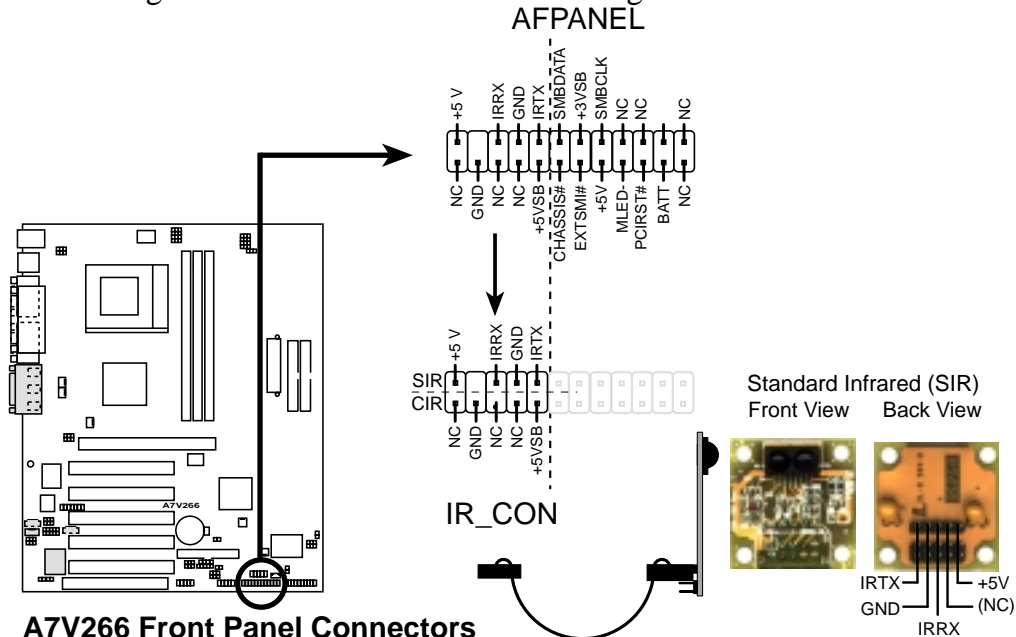

3. HW SETUP Connectors

# 3. HARDWARE SETUP

## 15) Power Supply Connectors (20-pin block ATXPWR)

This connector connects to an ATX 12V power supply. The plug from the power supply fits in only one orientation because of the different hole sizes. Find the proper orientation and push down firmly making sure that the pins are aligned.

**IMPORTANT:** Make sure that the ATX 12V power supply (minimum recommended wattage: 230W) can supply at least 10mA on the +5-volt standby lead (+5VSB). The system may become unstable and may experience difficulty powering up if the power supply is inadequate. For Wake-On-LAN support, the ATX power supply must supply at least 720mA +5VSB.

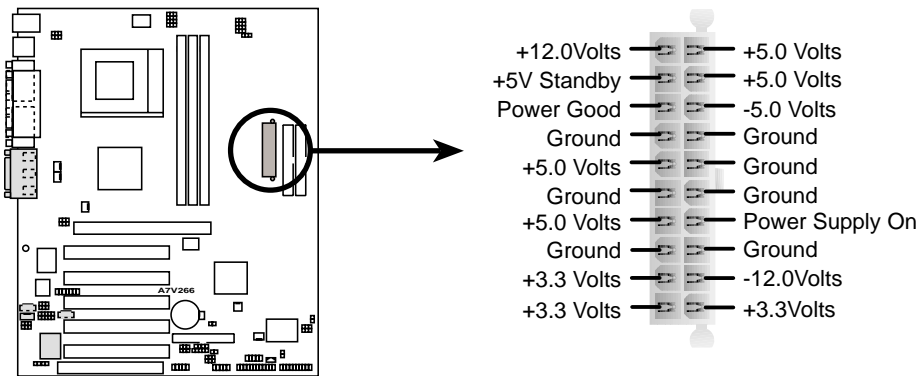

**A7V266 ATX Power Connector**

## 16) SMBus Connector (5-1 pin SMB)

This connector allows you to connect SMBus (System Management Bus) devices. SMBus devices communicate by means of the SMBus with an SMBus host and/or other SMBus devices. SMBus is a specific implementation of an I<sup>2</sup>C bus, a multi-device bus that allows multiple chips to connect to the same bus and enabling each one to act as a master by initiating data transfer.

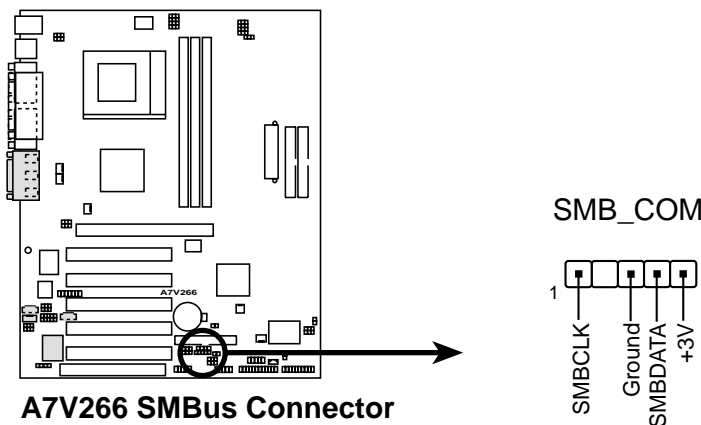

**A7V266 SMBus Connector**

# 3. HARDWARE SETUP

## 17) Internal Audio Connectors (4-1 pin CD, AUX, MODEM) (optional)

These connectors allow you to receive stereo audio input from sound sources as a CD-ROM, TV tuner, or MPEG card. The MODEM connector allows the onboard audio to interface with a voice modem card with a similar connector. It also allows the sharing of mono\_in (such as a phone) and a mono\_out (such as a speaker) between the audio and a voice modem card.

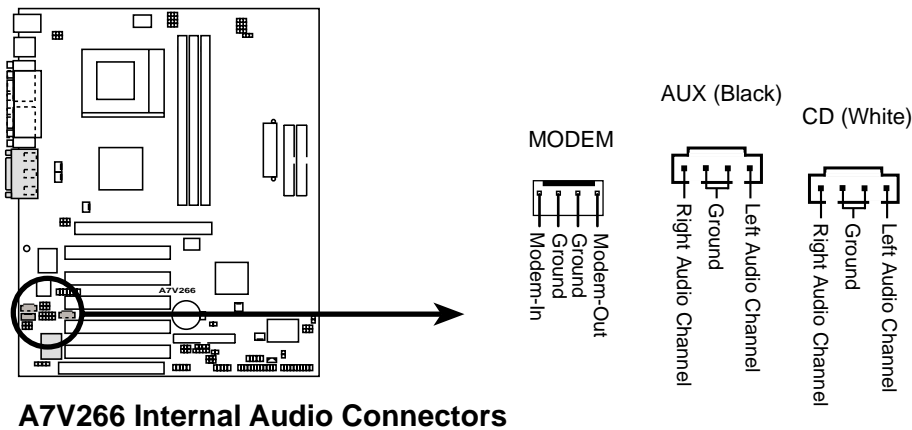

## 18) Internal Microphone Connector (3-pin MIC2) (optional)

This connector allows you to connect chassis-mounted microphone to the motherboard instead of connecting an external microphone to the ATX connector.

**NOTE:** The internal microphone does not work if there is an external microphone connected to the external Mic (pink) jack. You may only use one microphone at a time.

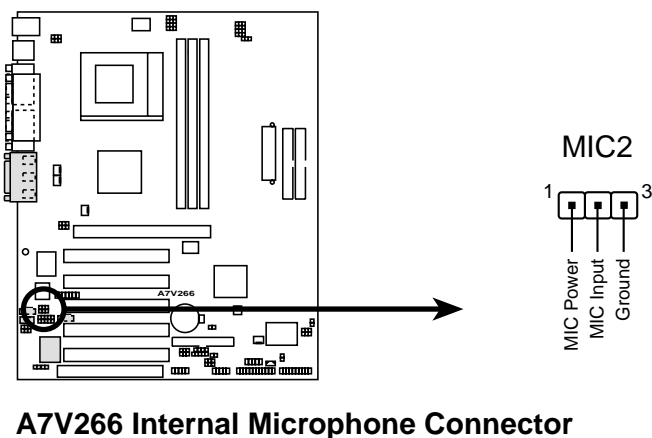

# 3. HARDWARE SETUP

## 19) Headphone True-level Line Out Header (3-pin HPHONE) *(optional)*

This connector allows you to connect chassis-mounted headphone to the motherboard instead of connecting an external headphone to the ATX connector.

**NOTE:** The internal microphone does not work if there is an external microphone connected to the external Mic (pink) jack. You may only use one microphone at a time.

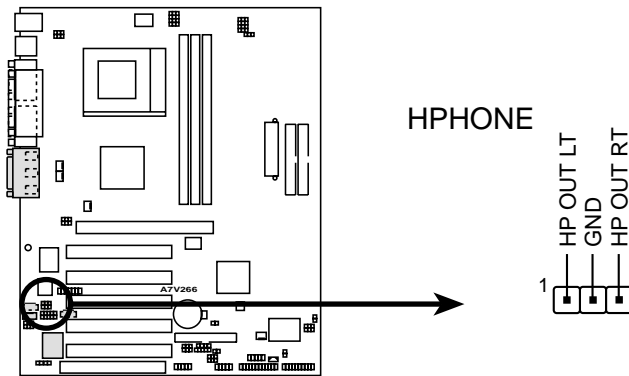

**A7V266 True-Level Line Out Header**

## 20) Power Supply Thermal Sensor Connector (2-pin JTPWR)

If you have a power supply with thermal monitoring, connect its thermal sensor cable to this connector.

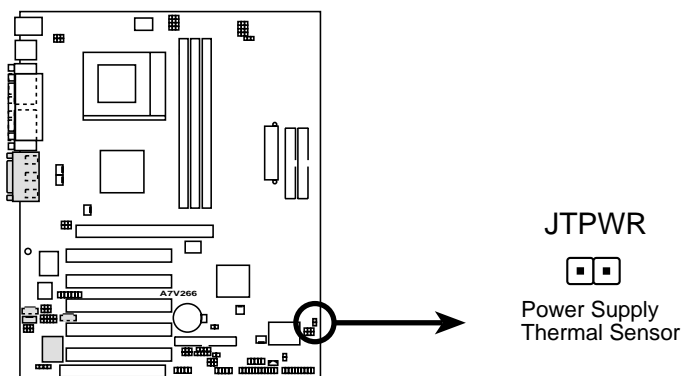

**A7V266 Thermal Sensor Connector**



# 3. HARDWARE SETUP

## 21) Digital Audio Interfaces (2-pin SPDIFOUT/CDSPDIFIN) *(optional)*

These connectors connect SPDIF audio cable that allows digital instead of analog sound output from CD-ROM, DVD-ROM, CD-RW, and advanced sound cards such as SoundBlaster. Live.

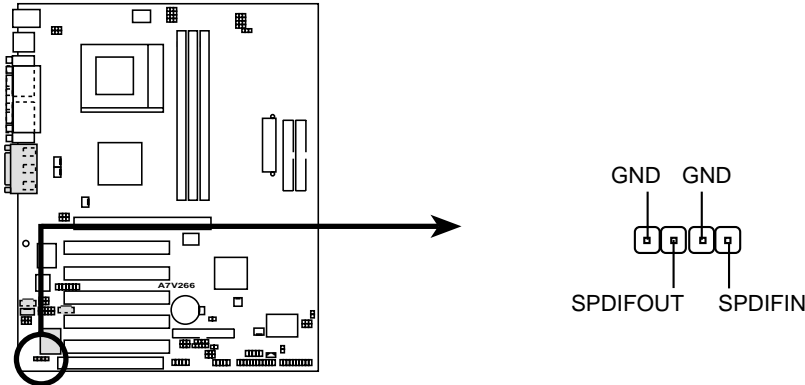

**A7V266 Digital Audio Interface**

## 22) Chassis Open Alarm Lead (4-pin CHASSIS)

This lead is for a chassis designed for chassis intrusion detection. This requires an external detection mechanism such as a chassis intrusion monitor/sensor or microswitch. When any chassis component is removed, the sensor is triggered and a high-level signal is sent to this lead to record a chassis intrusion event. The event is then be processed by software such as LDCM. When not using the chassis intrusion lead, place a jumper cap over the pins to close the circuit.

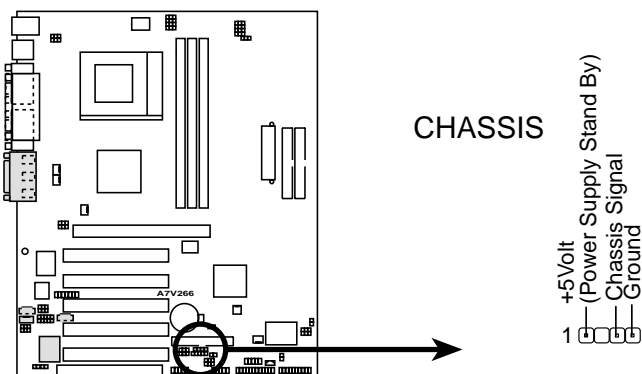

**A7V266 Chassis Open Alarm Lead**

# 3. HARDWARE SETUP

## 23) ASUS iPanel Audio Connector (10-1 pin AAPANEL)

Connect the audio cable from the optional ASUS iPanel to this for front panel audio control.

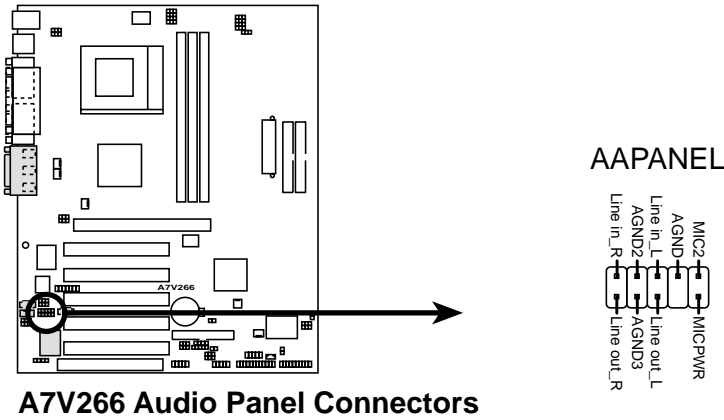

**A7V266 Audio Panel Connectors**

## 24) ASUS SmartCard Connector (14-1 pin SMARTCON)

This connector attaches to an optional SmartCard reader device. The SmartCard reader permits data access from the memory chip of PC/SC smart cards.

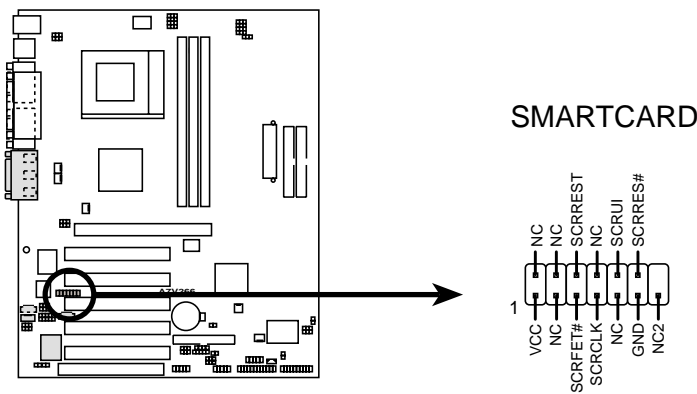

**A7V266 Smartcard**

# 3. HARDWARE SETUP

The following 20-pin PANEL illustration is for items 25-31.

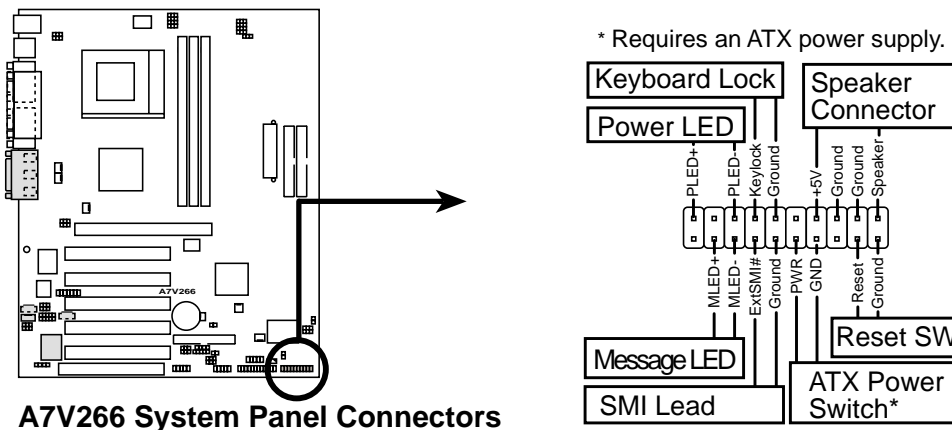

## 25) System Power LED Lead (3-1 pin PWR.LED)

This 3-1 pin connector connects to the system power LED. The LED lights up when you turn on the system power, and blinks when the system is in sleep or soft-off mode.

## 26) Keyboard Lock Switch Lead (2-pin KEYLOCK)

This 2-pin connector connects to the case-mounted key switch to allow keyboard locking.

## 27) System Warning Speaker Lead (4-pin SPEAKER)

This 4-pin connector connects to the case-mounted speaker and allows you to hear system beeps and warnings.

## 28) System Message LED Lead (2-pin MSG.LED)

This 2-pin connector is for the system message LED that indicates receipt of messages from a fax/modem. The normal status for this LED is ON, when there is no incoming data signal. The LED blinks when data is received. The system message LED feature requires an ACPI OS and driver support.

## 29) System Management Interrupt Lead (2-pin SMI)

This 2-pin connector allows you to manually place the system into a suspend mode, or “Green” mode, where system activity is instantly decreased to save power and to expand the life of certain system components. Attach the case-mounted suspend switch this 2-pin connector.

## 30) ATX Power Switch / Soft-Off Switch Lead (2-pin PWR.SW)

The system power is controlled by a momentary switch attached to this connector. Pressing the button switches the system between ON and SLEEP, or ON and SOFT OFF, depending on the BIOS or OS settings. Pressing the button while in the ON mode for more than 4 seconds turns the system off.

## 31) Reset Switch Lead (2-pin RESET)

This 2-pin connector connects to the case-mounted reset switch for rebooting the system without turning off the power switch. This is a preferred method.

# 3. HARDWARE SETUP

## 3.9 Starting Up the First Time

1. After making all the connections, replace the system case cover.
2. Be sure that all switches are off (in some systems, marked with ○).
3. Connect the AC cord to the power connector on the system chassis.
4. Connect the AC cord to an outlet equipped with a surge protector.
5. Turn on the devices in the following order:
  - a. Monitor
  - b. External SCSI devices (starting with the last device on the chain)
  - c. System power (For ATX power supplies, you need to switch on the power supply as well as press the ATX power switch on the front of the chassis.)
6. The power LED on the front panel of the system case lights up. For ATX power supplies, the system LED lights up when you press the ATX power switch. If the monitor complies with “green” standards or if it has a power standby feature, the monitor LED may light up or switch between orange and green after the system LED does. The system then runs the power-on tests. While the tests are running, the BIOS beeps or additional messages appear on the screen. If you do not see anything within 30 seconds from the time you turn on the power, the system may have failed a power-on test. Check the jumper settings and connections or call your retailer for assistance.

### Award BIOS Beep Codes

Beep	Meaning
One short beep when displaying logo	No error during POST
Long beeps in an endless loop	No DRAM installed or detected
One long beep followed by three short beeps	Video card not found or video card memory bad
High frequency beeps when system is working	CPU overheated System running at a lower frequency

7. At power on, hold down <Delete> to enter BIOS Setup. Follow the instructions in **4. BIOS SETUP**.

\* **Powering Off the computer:** You must first exit or shut down the system before switching off the power switch. For ATX power supplies, you can press the ATX power switch after exiting or shutting down the operating system. If you use Windows 9X, click the **Start** button, click **Shut Down**, then click **Shut down the computer?** The power supply should turn off after Windows shuts down.

**NOTE:** The message “You can now safely turn off your computer” does not appear when shutting down with ATX power supplies.

# 4. BIOS SETUP

## 4.1 Managing and Updating Your BIOS

### 4.1.1 Upon First Use of the Computer System

It is recommended that you save a copy of the original motherboard BIOS along with a Flash Memory Writer utility (AFLASH.EXE) to a bootable floppy disk in case you need to reinstall the BIOS later. **AFLASH.EXE** is a Flash Memory Writer utility that updates the BIOS by uploading a new BIOS file to the programmable flash ROM on the motherboard. This file works only in DOS mode. To determine the BIOS version of your motherboard, check the last four numbers of the code displayed on the upper left-hand corner of your screen during bootup. Larger numbers represent a newer BIOS file.

1. Type **FORMAT A:/S** at the DOS prompt to create a bootable system disk. **DO NOT** copy AUTOEXEC.BAT and CONFIG.SYS to the disk.
2. Type **COPY D:\AFLASH\AFLASH.EXE A:\** (assuming D is your CD-ROM drive) to copy AFLASH.EXE to the boot disk you created.  
**NOTE:** AFLASH works only in DOS mode. It does not work in the DOS prompt within Windows and does not work with certain memory drivers that may be loaded when you boot from the hard drive. It is recommended that you reboot using a floppy disk.
3. Reboot the computer from the floppy disk.

**NOTE:** BIOS setup must specify “Floppy” as the first item in the boot sequence.

4. In DOS mode, type **A:\AFLASH <Enter>** to run AFLASH.



```
ASUS ACPI BIOS
FLASH MEMORY WRITER V1.29
Copyright (C) 1994-99, ASUSTeK COMPUTER INC.

Flash Memory: Winbond W29C020 or SST 29EE020 or Intel B28H20E

Current BIOS Version: ASUS XXX-XX ACPI BIOS Revision 1BBX
BIOS Model          : XXX-XX
BIOS Built Date     : 00/25/98

Choose one of the followings:
1. Save Current BIOS To File
2. Update BIOS Including Boot Block and ESCD

Enter choice: [1]

Press ESC To Exit
```

**IMPORTANT!** If the word “unknown” appears after **Flash Memory:**, the memory chip is either not programmable or is not supported by the ACPI BIOS and therefore, cannot be programmed by the Flash Memory Writer utility.

## 4. BIOS SETUP

---

5. Select **1. Save Current BIOS to File** from the Main menu and press <Enter>. The **Save Current BIOS To File** screen appears.

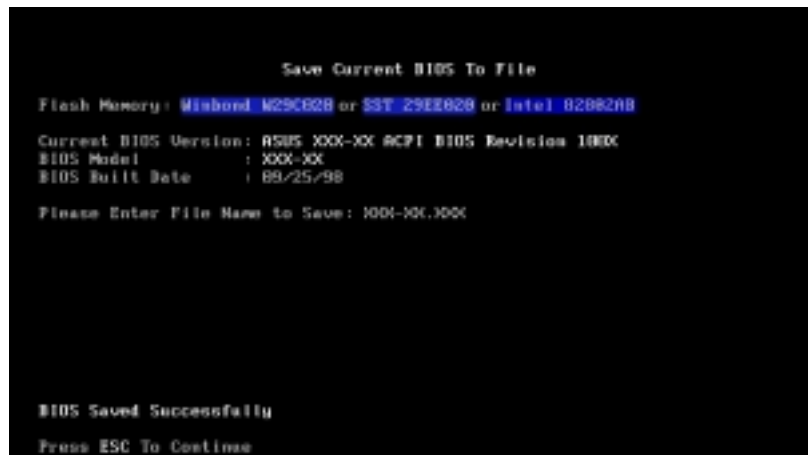

6. Type a filename and the path, for example, **A:\XXX-XX.XXX** and then press <Enter>.

# 4. BIOS SETUP

## 4.1.2 Updating BIOS Procedures

**WARNING!** Update the BIOS only if you have problems with the motherboard and you know that the new BIOS revision will solve your problems. Careless updating can result in your motherboard having more problems!

1. Download an updated ASUS BIOS file from the Internet (WWW or FTP) (see ASUS CONTACT INFORMATION on page 3 for details) and save to the boot floppy disk you created earlier.
2. Boot from the floppy disk.
3. At the “A:\” prompt, type **AFLASH** and then press <Enter>.
4. At the **Main Menu**, type **2** then press <Enter>. The **Update BIOS Including Boot Block and ESCD** screen appears.
5. Type the filename of your new BIOS and the path, for example, **A:\XXX-XX.XXX**, then press <Enter>.

**NOTE:** To cancel this operation, press <Enter>.

```
Update BIOS Including Boot Block and ESCD
Flash Memory: Winbond W29C02B or SST 29EE020 or Intel B28H28B
Current BIOS Version: ASUS XXX-XX ACPI BIOS Revision 188X
BIOS Model          : XXX-XX
BIOS Built Date     : 09/25/99
Please Enter File Name for NEW BIOS: A:\XXX-XX.XXX
```

6. When prompted to confirm the BIOS update, press **Y** to start the update.

```
Update BIOS Including Boot Block and ESCD
Flash Memory: Winbond W29C02B or SST 29EE020 or Intel B28H28B
BIOS Version
(CURRENT) ASUS XXX-XX ACPI BIOS Revision 188X
(test.ewd) ASUS XXX-XX ACPI BIOS Revision 188X
BIOS Model
(CURRENT) XXX-XX
(test.ewd) XXX-XX
Date of BIOS Built
(CURRENT) 09/25/99
(XXXX, XXXX) 05/29/99
Check sum of 1881,018 is F286.
Are you sure (Y/N) ? [Y]
Press ESC To Return to Main Menu
```

4. BIOS SETUP  
Updating BIOS

# 4. BIOS SETUP

- The utility starts to program the new BIOS information into the Flash ROM. The boot block is updated automatically only when necessary. This minimizes the possibilities of boot problems in case of update failures. When the programming is done, *Flashed Successfully* appears.

```
Update BIOS Including Boot Block and ESCD
Flash Memory: Winbond W29C020 or SST 29EE020 or Intel 028020B
BIOS Version
(CURRENT) ASUS XXX-XX ACPI BIOS Revision 100X
(TEST.AMD) ASUS XXX-XX ACPI BIOS Revision 100X
BIOS Model
(CURRENT) XXX-XX
(TEST.AMD) XXX-XX
Date of BIOS Built
(CURRENT) 05/29/99
(INFORM) XXXX 05/29/00
Check sum of 1001,010 is F266.
Are you sure (Y/N) ? [Y]
Block Erasing -- Done
Programming -- 3FFFF
Flashed Successfully
Press ESC To Continue
```

- Follow the onscreen instructions to continue.

```
ASUS ACPI BIOS
FLASH MEMORY WRITER V1.29
Copyright (C) 1994-99, ASUSTek COMPUTER INC.
Flash Memory: Winbond W29C020 or SST 29EE020 or Intel 028020B
Current BIOS Version: ASUS XXX-XX ACPI BIOS Revision 100X
BIOS Model : XXX-XX
BIOS Built Date : 05/29/99
Choose one of the followings:
1. Save Current BIOS To File
2. Update BIOS Including Boot Block and ESCD
Enter choice: [1]
You have flashed the EPROM; it is recommended that you turn off
the power, enter SETUP and Load Setup Defaults to have CMOS
updated with new BIOS when exits.
Press ESC To Exit
```

**WARNING!** If you encounter problems while updating the new BIOS, DO NOT turn off the system because this may cause boot problems. Just repeat the process, and if the problem still persists, load the original BIOS file you saved to the boot disk. If the Flash Memory Writer utility is not able to successfully update a complete BIOS file, the system may not boot. If this happens, call the ASUS service center for support.



# 4. BIOS SETUP

---

## 4.2 BIOS Setup Program

This motherboard supports a programmable EEPROM that you can update using the provided utility described in *4.1 Managing and Updating Your BIOS*.

The utility is used if you are installing a motherboard, reconfiguring your system, or prompted to “**Run Setup**”. This section describes how to configure your system using this utility.

Even if you are not prompted to use the Setup program, at some time in the future you may want to change the configuration of your computer. For example, you may want to enable the Security Password Feature or make changes to the power management settings. It will then be necessary to reconfigure your system using the BIOS Setup program so that the computer can recognize these changes and record them in the CMOS RAM of the EEPROM.

The EEPROM on the motherboard stores the Setup utility. When you start up the computer, the system provides you with the opportunity to run this program. This appears during the Power-On Self Test (POST). Press <Delete> to call up the Setup utility. If you are a little bit late in pressing the mentioned key, POST will continue with its test routines, thus preventing you from calling up Setup. If you still need to call Setup, restart the system by pressing <Ctrl> + <Alt> + <Delete>, or by pressing the Reset button on the system chassis. You can also restart by turning the system off and then back on again. But do so only if the first two methods fail.

The Setup program has been designed to make it as easy to use as possible. It is a menu-driven program, which means you can scroll through the various sub-menus and make your selections among the predetermined choices.

**To access the BIOS Setup program, press the <Delete> key after the computer has run through its POST.**

**NOTE:** Because the BIOS software is constantly being updated, the following BIOS setup screens and descriptions are for reference purposes only, and may not exactly match what you see on your screen.

# 4. BIOS SETUP

## 4.2.1 BIOS Menu Bar

The top of the screen has a menu bar with the following selections:

- MAIN** Use this menu to make changes to the basic system configuration.
- ADVANCED** Use this menu to enable and make changes to the advanced features.
- POWER** Use this menu to configure and enable Power Management features.
- BOOT** Use this menu to configure the default system device used to locate and load the Operating System.
- EXIT** Use this menu to exit the current menu or specify how to exit the Setup program.

To access the menu bar items, press the right or left arrow key on the keyboard until the desired item is highlighted.

## 4.2.2 Legend Bar

At the bottom of the Setup screen is a legend bar. The keys in the legend bar allow you to navigate through the various setup menus. The following table lists the keys found in the legend bar with their corresponding functions.

Navigation Key(s)	Function Description
<F1> or <Alt + H>	Displays the General Help screen from anywhere in the BIOS Setup
<Esc>	Jumps to the Exit menu or returns to the main menu from a sub-menu
← or → (keypad arrow)	Selects the menu item to the left or right
↑ or ↓ (keypad arrow)	Moves the highlight up or down between fields
- (minus key)	Scrolls backward through the values for the highlighted field
+ (plus key) or spacebar	Scrolls forward through the values for the highlighted field
<Enter>	Brings up a selection menu for the highlighted field
<Home> or <PgUp>	Moves the cursor to the first field
<End> or <PgDn>	Moves the cursor to the last field
<F5>	Resets the current screen to its Setup Defaults
<F10>	Saves changes and exits Setup

# 4. BIOS SETUP

---

## General Help

In addition to the Item Specific Help window, the BIOS setup program also provides a General Help screen. You may launch this screen from any menu by simply pressing <F1> or the <Alt> + <H> combination. The General Help screen lists the legend keys with their corresponding functions.

## Saving Changes and Exiting the Setup Program

See *4.7 Exit Menu* for detailed information on saving changes and exiting the setup program.

## Scroll Bar

When a scroll bar appears to the right of a help window, it indicates that there is more information to be displayed that will not fit in the window. Use <PgUp> and <PgDn> or the up and down arrow keys to scroll through the entire help document. Press <Home> to display the first page, press <End> to go to the last page. To exit the help window, press <Enter> or <Esc>.

## Sub-Menu

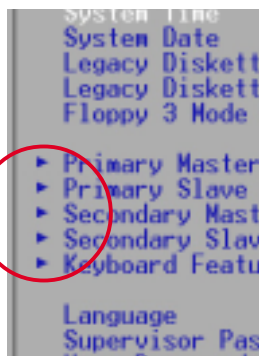

Note that a right pointer symbol (as shown in the left view) appears to the left of certain fields. This pointer indicates that you can display a sub-menu from this field. A sub-menu contains additional options for a field parameter. To display a sub-menu, move the highlight to the field and press <Enter>. The sub-menu appears. Use the legend keys to enter values and move from field to field within a sub-menu as you would within a menu. Use the <Esc> key to return to the main menu.

Take some time to familiarize yourself with the legend keys and their corresponding functions. Practice navigating through the various menus and sub-menus. If you accidentally make unwanted changes to any of the fields, use the set default hot key <F5> to load the Setup default values. While moving around through the Setup program, note that explanations appear in the Item Specific Help window located to the right of each menu. This window displays the help text for the currently highlighted field.

**NOTE:** The item heading in square brackets represents the default setting for that field.

# 4. BIOS SETUP

## 4.3 Main Menu

When you enter the Setup program, the following screen appears:

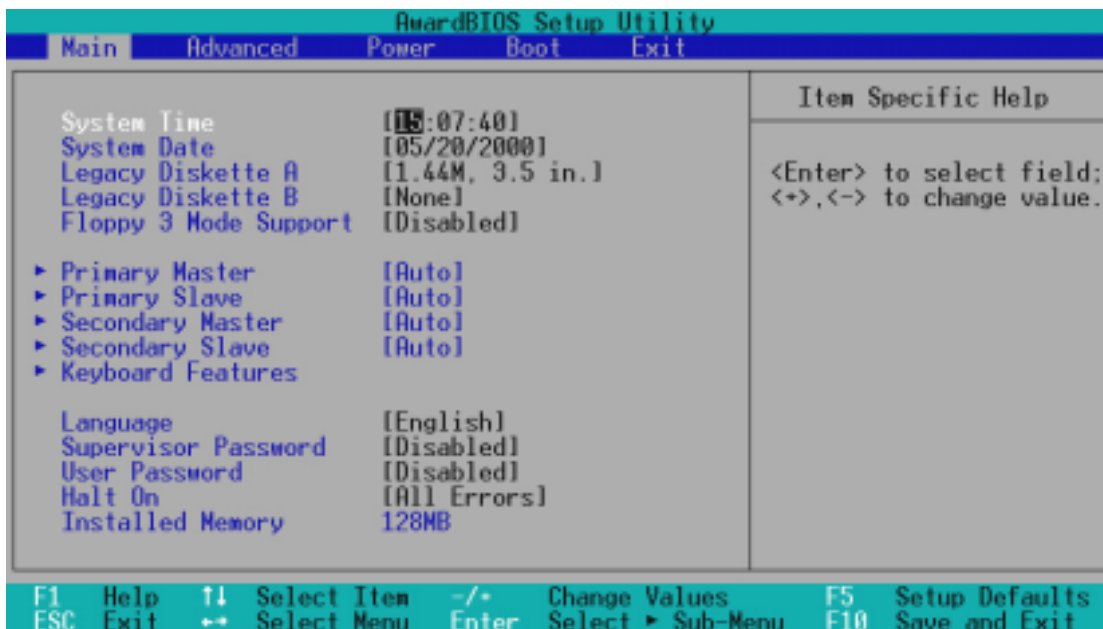

### System Time [XX:XX:XX]

Sets the system to the time that you specify (usually the current time). The format is hour, minute, second. Valid values for hour, minute and second are **Hour: (00 to 23)**, **Minute: (00 to 59)**, **Second: (00 to 59)**. Use the <Tab> or <Shift> + <Tab> keys to move between the hour, minute, and second fields.

### System Date [XX/XX/XXXX]

Sets the system to the date that you specify (usually the current date). The format is month, day, year. Valid values for month, day, and year are **Month: (1 to 12)**, **Day: (1 to 31)**, **Year: (100 year range)**. Use the <Tab> or <Shift> + <Tab> keys to move between the month, day, and year fields.

### Legacy Diskette A [1.44M, 3.5 in.], Legacy Diskette B [None]

Sets the type of floppy drives installed. Configuration options: [None] [360K, 5.25 in.] [1.2M, 5.25 in.] [720K, 3.5 in.] [1.44M, 3.5 in.] [2.88M, 3.5 in.]

### Floppy 3 Mode Support [Disabled]

This is required to support older Japanese floppy drives. The Floppy 3 Mode feature allows reading and writing of 1.2MB (as opposed to 1.44MB) on a 3.5-inch diskette. Configuration options: [Disabled] [Enabled]

# 4. BIOS SETUP

## 4.3.1 Primary & Secondary Master/Slave

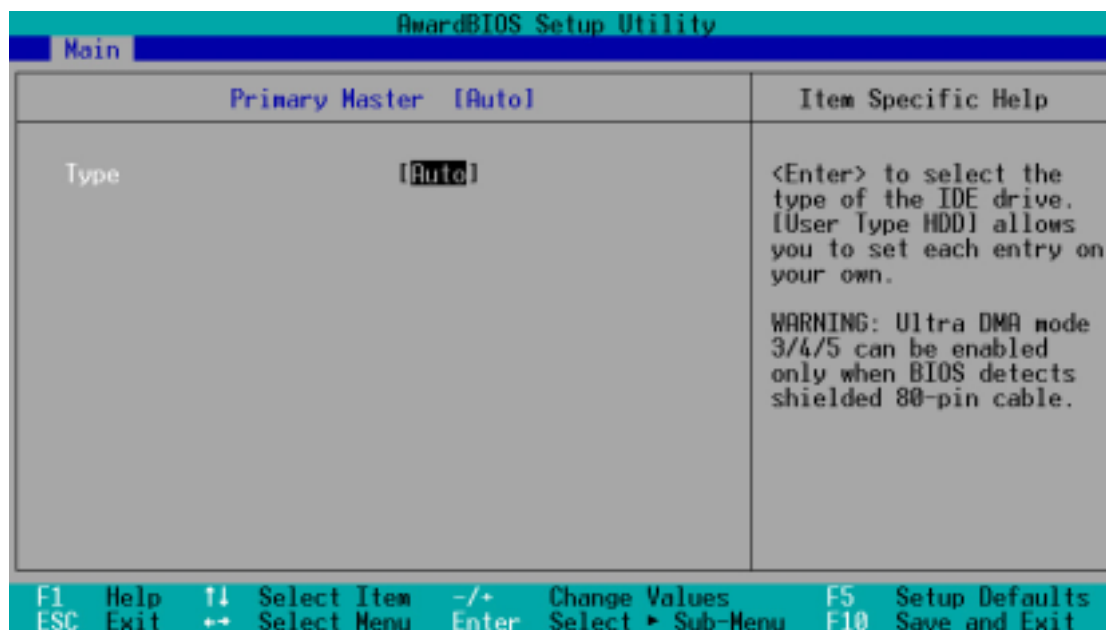

### Type [Auto]

Select [Auto] to automatically detect an IDE hard disk drive. If automatic detection is successful, Setup automatically fills in the correct values for the remaining fields on this sub-menu. If automatic detection fails, this may be because the hard disk drive is too old or too new. If the hard disk was already formatted on an older system, Setup may detect incorrect parameters. In these cases, select [User Type HDD] to manually enter the IDE hard disk drive parameters. Refer to the next section for details.

**NOTE:** After entering the IDE hard disk drive information into BIOS, use a disk utility, such as FDISK, to partition and format new IDE hard disk drives. This is necessary so that you can write or read data from the hard disk. Make sure to set the partition of the Primary IDE hard disk drives to active.

**CAUTION!** Before attempting to configure a hard disk drive, make sure you have the configuration information supplied by the drive manufacturer. Incorrect settings may cause the system to fail to recognize the installed hard disk.

# 4. BIOS SETUP

## [User Type HDD]

AwardBIOS Setup Utility		Item Specific Help
Main		
Primary Master [User Type HDD]		
Type	[User Type HDD]	<Enter> to select the type of the IDE drive. [User Type HDD] allows you to set each entry on your own.  WARNING: Ultra DMA mode 3/4/5 can be enabled only when BIOS detects shielded 80-pin cable.
Translation Method	[LBA]	
Cylinders	[ 1024]	
Head	[255]	
Sector	[63]	
CHS Capacity	8422MB	
Maximum LBA Capacity	25590MB	
Multi-Sector Transfers	[Maximum]	
SMART Monitoring	[Disabled]	
PIO Mode	[4]	
ULTRA DMA Mode	[Disabled]	
F1 Help   ↑↓ Select Item   +/- Change Values   F5 Setup Defaults ESC Exit   ++ Select Menu   Enter Select Sub-Menu   F10 Save and Exit		

Manually enter the number of cylinders, heads and sectors per track for the drive. Refer to the drive documentation or on the drive label for this information. If no drive is installed or if you are removing a drive and not replacing it, select [None].

### Translation Method [LBA]

Select the hard disk drive type in this field. When Logical Block Addressing (LBA) is enabled, 28-bit addressing of the hard drive disregarding cylinders, heads, or sectors. Note that LBA Mode is necessary for drives with more than 504MB storage capacity. Configuration options: [LBA] [LARGE] [Normal] [Match Partition Table] [Manual]

### Cylinders

This field configures the number of cylinders. Refer to the drive documentation to determine the correct value to enter into this field. **NOTE:** To make changes to this field, set the **Type** field to [User Type HDD] and the **Translation Method** field to [Manual].

### Head

This field configures the number of read/write heads. Refer to the drive documentation to determine the correct value to enter into this field. **NOTE:** To make changes to this field, set the **Type** field to [User Type HDD] and the **Translation Method** field to [Manual].

### Sector

This field configures the number of sectors per track. Refer to the drive documentation to determine the correct value to enter into this field. **NOTE:** To make changes to this field, set the **Type** field to [User Type HDD] and the **Translation Method** field to [Manual].

## 4. BIOS SETUP

---

### **CHS Capacity**

This field shows the drive's maximum CHS capacity as calculated by the BIOS based on the drive information you entered.

### **Maximum LBA Capacity**

This field shows the drive's maximum LBA capacity as calculated by the BIOS based on the drive information you entered.

### **Multi-Sector Transfers [Maximum]**

This option automatically sets the number of sectors per block to the highest number that the drive supports. Note that when this field is automatically configured, the set value may not always be the fastest value for the drive. You may also manually configure this field. Refer to the documentation that came with the hard drive to determine the optimum value and set it manually. **NOTE:** To make changes to this field, set the **Type** field to [User Type HDD]. Configuration options: [Disabled] [2 Sectors] [4 Sectors] [8 Sectors] [16 Sectors] [32 Sectors] [Maximum]

### **SMART Monitoring [Disabled]**

This field allows you to enable or disable the S.M.A.R.T. (Self-Monitoring, Analysis and Reporting Technology) system that utilizes internal hard disk drive monitoring technology. This parameter is normally disabled because the resources used in the SMART monitoring feature may decrease system performance. Configuration options: [Disabled] [Enabled]

### **PIO Mode [4]**

This option lets you set a PIO (Programmed Input/Output) mode for the IDE device. Modes 0 through 4 provide successively increased performance. Configuration options: [0] [1] [2] [3] [4]

### **Ultra DMA Mode [Disabled]**

Ultra DMA capability allows improved transfer speeds and data integrity for compatible IDE devices. Set to [Disabled] to suppress Ultra DMA capability.

**NOTE:** To make changes to this field, set the **Type** field to [User Type HDD]. Configuration options: [0] [1] [2] [3] [4] [5] [Disabled]

Other options for the **Type** field are:

**[CD-ROM]** - for IDE CD-ROM drives

**[LS-120]** - for LS-120 compatible floppy disk drives

**[ZIP-100]** - for ZIP-100 compatible disk drives

**[MO]** - for IDE magneto optical disk drives

**[Other ATAPI Device]** - for IDE devices not listed here

After making your selections on this sub-menu, press the <Esc> key to return to the Main menu. When the Main menu appears, the hard disk drive field displays the size for the hard disk drive that you configured.

# 4. BIOS SETUP

## 4.3.2 Keyboard Features

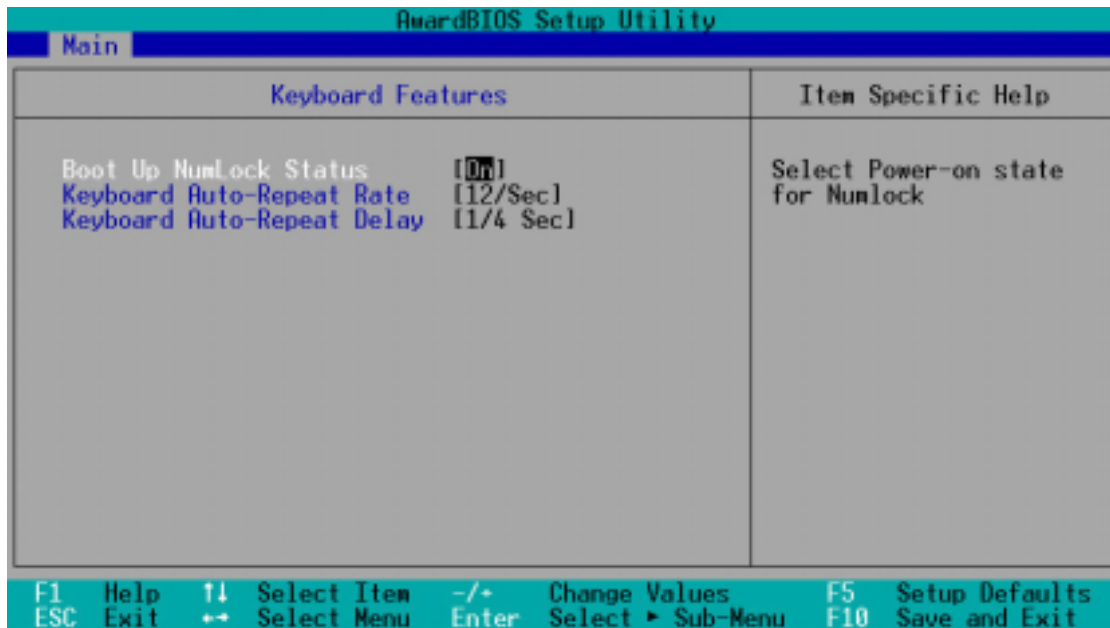

### Boot Up NumLock Status [On]

This field enables users to activate the Number Lock function upon system boot. Configuration options: [Off] [On]

### Keyboard Auto-Repeat Rate [12/Sec]

This controls the speed at which the system registers repeated keystrokes. Options range from 6 to 30 characters per second. Configuration options: [6/Sec] [8/Sec] [10/Sec] [12/Sec] [15/Sec] [20/Sec] [24/Sec] [30/Sec]

### Keyboard Auto-Repeat Delay [1/4 Sec]

This field sets the time interval for displaying the first and second characters. Configuration options: [1/4 Sec] [1/2 Sec] [3/4 Sec] [1 Sec]



## 4. BIOS SETUP

---

### **Language [English]**

This field displays the BIOS language version.

### **Supervisor Password [Disabled] / User Password [Disabled]**

These fields allow you to set passwords. To set a password, highlight the appropriate field and press <Enter>. Type in a password then press <Enter>. You can type up to eight alphanumeric characters. Symbols and other characters are ignored. To confirm the password, type the password again and press <Enter>. The password is now set to [Enabled]. This password allows full access to the BIOS Setup menus. To clear the password, highlight this field and press <Enter>. The same dialog box as above appears. Press <Enter>. The password is set to [Disabled].

### **A Note about Passwords**

The BIOS Setup program allows you to specify passwords in the Main menu. The passwords control access to the BIOS during system startup. Passwords are not case sensitive, meaning, it makes no difference whether you the password using uppercase or lowercase letters. The BIOS Setup program allows you to specify two different passwords: a Supervisor password and a User password. If you did not set a Supervisor password, anyone can access the BIOS Setup program. If you did, the Supervisor password is required to enter the BIOS Setup program and to gain full access to the configuration fields.

### **Forgot the Password?**

If you forget your password, you can clear it by erasing the CMOS Real Time Clock (RTC) RAM. The RAM data containing the password information is powered by the onboard button cell battery.

To erase the RTC RAM:

1. Turn OFF the computer and unplug the power cord.
2. Remove the battery.
3. Short the jumper.
4. Re-install the battery.
5. Plug the power cord and turn ON the computer.
6. Hold down the <Del> key during the boot process and enter BIOS setup to re-enter data.

### **Halt On [All Errors]**

This field specifies the types of errors that will cause the system to halt. Configuration options: [All Errors] [No Error] [All but Keyboard] [All but Disk] [All but Disk/Keyboard]

### **Installed Memory [XXX MB]**

This field automatically displays the amount of conventional memory detected by the system during the boot process.

# 4. BIOS SETUP

## 4.4 Advanced Menu

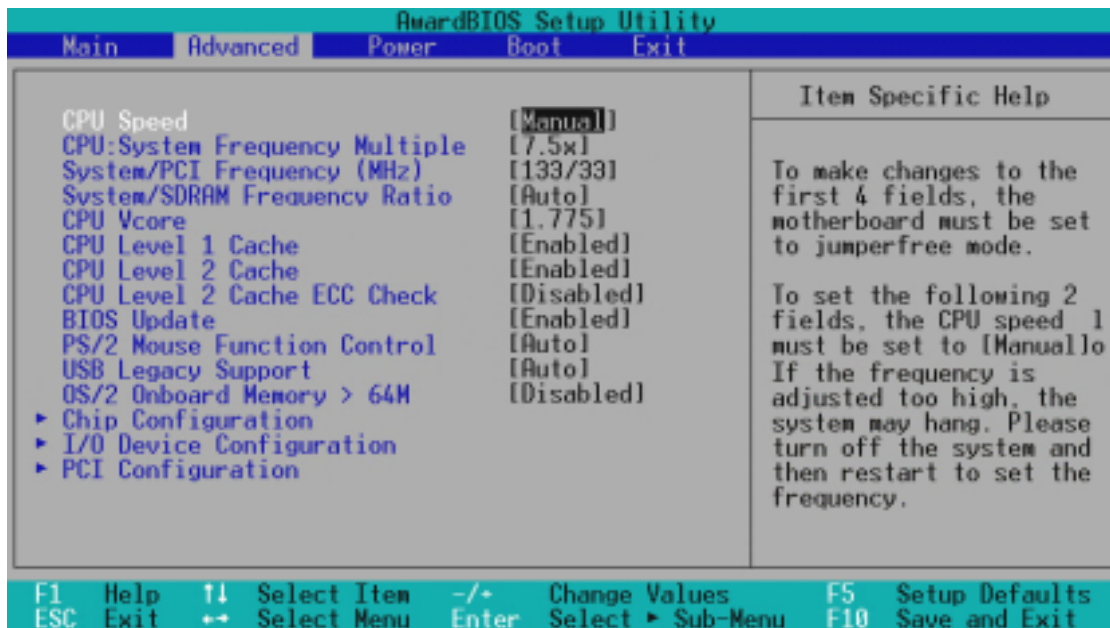

### CPU Speed [Manual]

When the motherboard is set to JumperFree™ mode, this field sets the internal frequency of your CPU. Select [Manual] if you want to make changes to the next two fields. Note that selecting a frequency higher than the CPU manufacturer recommends may cause the system to hang or crash. Configuration options: [Manual] [750MHz] [1000MHz]

### CPU : System Frequency Multiple, (if CPU Speed set to [Manual])

This field is for unlocked processors only and will not be available to standard AMD processors. If the processor frequency multiple is detected as being locked, you cannot access this field. For unlocked processors, this field sets the frequency multiple between the CPU's *internal* frequency (CPU speed) and the *external* frequency. Set this field in conjunction with the **System/PCI Frequency (MHz)** to match the speed of the CPU. Configuration options: [5x/14x] [5.5x] [6.0x]...[12.0x] [12.5x]

### System/PCI Frequency (MHz) (if CPU Speed set to [Manual])

This feature tells the clock generator what frequency to send to the system bus and PCI bus. The bus frequency (external frequency) multiplied by the bus multiple equals the **CPU speed**. Configuration ranges from 100/33 to 227/57.

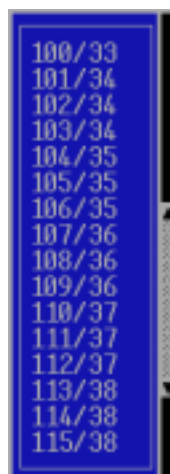

## 4. BIOS SETUP

---

### **System/SDRAM Frequency Ratio [Auto]**

This field determines whether the memory clock frequency is set to be in synchronous or asynchronous mode with respect to the system frequency. The options that appear in the popup menu vary according to the **System/PCI Frequency (MHz)**. Configuration options: [Auto] [100:100] [100:133]

### **Vcore [1.775V]**

This field determines the range of core voltage available to the Central Processing Unit. Configuration options: [1.800] [1.775] [1.750] [1.725] [1.700] [1.675] [1.625]

### **CPU Level 1 Cache, CPU Level 2 Cache [Enabled]**

These fields allow you to choose from the default of [Enabled] or choose [Disabled] to turn on or off the CPU Level 1 and Level 2 built-in cache. Configuration options: [Disabled] [Enabled]

### **CPU Level 2 Cache ECC Check [Disabled]**

This function controls the ECC capability in the CPU level 2 cache. Configuration options: [Disabled] [Enabled]

### **BIOS Update [Enabled]**

This field functions as an update loader integrated into the BIOS to supply the processor with the required data. When set to [Enabled], the BIOS loads the update on all processors during system bootup. Configuration options: [Disabled] [Enabled]

### **PS/2 Mouse Function Control [Auto]**

The default setting [Auto] allows the system to detect a PS/2 mouse at startup. If a mouse is detected, the BIOS assigns IRQ12 to the PS/2 mouse. Otherwise, IRQ12 can be used for expansion cards. When you set this field to [Enabled], BIOS always reserves IRQ12, whether or not a PS/2 mouse is detected at startup. Configuration options: [Enabled] [Auto]

### **USB Legacy Support [Auto]**

This motherboard supports Universal Serial Bus (USB) devices. The default of [Auto] allows the system to detect a USB device at startup. If detected, the USB controller is enabled. If not detected, the USB controller is disabled. When you set this field to [Disabled], the USB controller is disabled whether you are using a USB device or not. Configuration options: [Disabled] [Enabled] [Auto]

### **OS/2 Onboard Memory > 64M [Disabled]**

When using OS/2 operating systems with installed DRAM of greater than 64MB, you need to set this option to [Enabled]. Otherwise, leave to the default setting [Disabled]. Configuration options: [Disabled] [Enabled]

# 4. BIOS SETUP

## Notes for JumperFree Mode CPU Upgrade/Reinstallation

To ensure that the system can enter BIOS Setup after changing the processor, the system starts up running at a bus speed of 100MHz and a fail-safe CPU internal frequency. Then it automatically enters the Advanced menu with a popup display of all the possible CPU internal frequencies.

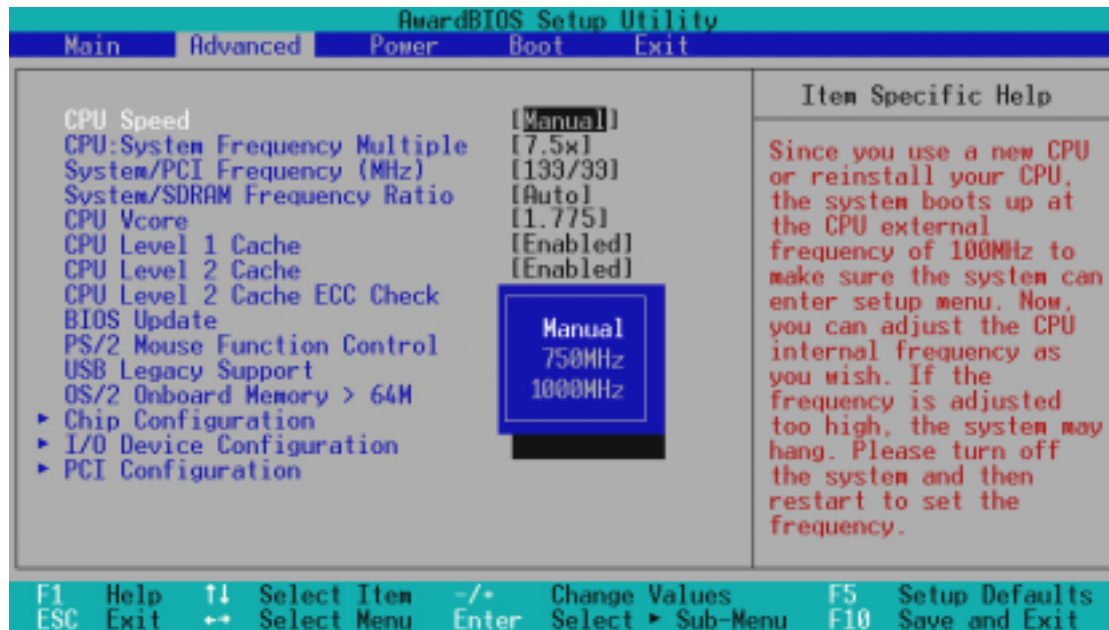

**For processors with locked frequency multiplier**

# 4. BIOS SETUP

## System Hangup

If the system crashes or hangs due to improper frequency settings, power OFF the system and restart. The system starts up in safe mode running at a bus speed of 100MHz and enters the BIOS Setup.

AwardBIOS Setup Utility				
Main	Advanced	Power	Boot	Exit
CPU Speed	[750MHz]			Item Specific Help
CPU: System Frequency Multiple	[7.5x]			During the last boot-up, your system hung for an
System/PCI Frequency (MHz)	[133/33]			
System/SDRAM Frequency Ratio	[Auto]			

**Cause for Hangup: Improper CPU Speed**

AwardBIOS Setup Utility				
Main	Advanced	Power	Boot	Exit
CPU Speed	[Manual]			Item Specific Help
CPU: System Frequency Multiple	[7.5x]			During the last boot-up, your system hung for
System/PCI Frequency (MHz)	[133/33]			
System/SDRAM Frequency Ratio	[Auto]			

**Cause for Hangup: Improper CPU: System Frequency Multiple  
(For processors with unlocked frequency multiplier only)**

AwardBIOS Setup Utility				
Main	Advanced	Power	Boot	Exit
CPU Speed	[Manual]			Item Specific Help
CPU: System Frequency Multiple	[7.5x]			During the last boot-up, your system hung for
System/PCI Frequency (MHz)	[ <del>133/33</del> ]			
System/SDRAM Frequency Ratio	[Auto]			

**Cause for Hangup: Improper System/SDRAM Frequency**

# 4. BIOS SETUP

## 4.4.1 Chip Configuration



(Scroll down to see more items as shown)

### SDRAM Configuration [By SPD]

This sets the optimal timings for items 2–5, depending on the memory modules that you are using. The default setting is [By SPD], which configures items 2–5 by reading the contents in the SPD (Serial Presence Detect) device. The EEPROM on the memory module stores critical parameter information about the module, such as memory type, size, speed, voltage interface, and module banks. Configuration options: [User Defined] [7ns (143MHz)] [8ns (125MHz)] [By SPD]

### SDRAM CAS Latency [DDR:2.ST;SDR:3]

This controls the latency between the SDRAM read command and the time that the data actually becomes available. **NOTE:** This field appears only when you set the **SDRAM Configuration** to [User Defined]. Configuration options: [DDR:2.ST;SDR:3T] [2T]

### SDRAM RAS Precharge Time [2T]

This controls the idle clocks after issuing a precharge command to the SDRAM. **NOTE:** This field appears only when you set the **SDRAM Configuration** to [User Defined]. Configuration options: [3T] [2T]

## 4. BIOS SETUP

---

### **SDRAM RAS to CAS Delay [3T]**

This controls the latency between the SDRAM active command and the read/write command. **NOTE:** This field appears only when you set the **SDRAM Configuration** to [User Defined]. Configuration options: [3T] [2T]

### **SDRAM Active to Precharge Time [6T]**

To make changes to this field, set the SDRAM Configuration field to [User Defined]. Configuration options: [6T] [5T]A7V

### **Bank Interleave [Auto]**

Configuration options: [None] [2 Banks] [4 Banks] [Auto]

### **DRAM 4K/8K Page Enable [Auto]**

Configuration options: [Auto] [4K page enable] [8K page enable]

### **DDR\_1T/2T\_ITEM [2T CMD]**

Configuration options: [1T CMD] [2T CMD] [Auto Mode]

### **Read Around Write [Enabled]**

Setting this field to [Enabled] allows the memory controller to store write data in its buffer whenever the CPU issues a write command. The next time the CPU needs the data, it retrieves the data from the memory buffer without accessing the SDRAM. Configuration options: [Disabled] [Enabled]

### **Delayed Transaction [Disabled]**

When set to [Enabled], this feature frees the PCI bus when the CPU is accessing 8-bit ISA cards. This process normally consumes about 50-60 PCI Clocks without PCI delayed transaction. Set this field to [Disabled] when using ISA cards that are not PCI 2.1 compliant. Configuration options: [Enabled] [Disabled]

### **PCI to DRAM Prefetch [Always prefetc]**

Configuration options: [Always Prefetch] [Prefetch disabled] [Prefetch only enhance command]

### **AGP Capability [4X Mode]**

This motherboard supports the AGP 4x interface that transfers video data at 1066MB/s. AGP 4x is backward-compatible, so you may leave the default [4X Mode] on even if you are using an AGP 1x or 2x video card. When set to [1X Mode], the AGP interface only provides a peak data throughput of 266MB/s even if you are using an AGP 2x/4x card. When set to [2X Mode], the AGP interface only provides a peak data throughput of 533MB/s even if you are using an AGP 4x card. Configuration options: [1X Mode] [2X Mode] [4X Mode]

## 4. BIOS SETUP

---

### **AGP Fast Write [Disabled]**

Configuration options: [Disabled] [Enabled]

### **AGP Drive Strength [Auto]**

Configuration options: [Auto] [Manual]

### **Graphics Aperture Size [32MB]**

This feature allows you to select the size of mapped memory for AGP graphic data. Configuration options: [4MB] [8MB] [16MB] [32MB] [64MB] [128MB] [256MB]

### **Video Memory Cache Mode [UC]**

USWC (uncacheable, speculative write combining) is a new cache technology for the video memory of the processor. It can greatly improve the display speed by caching the display data. You must set this to UC (uncacheable) if your display card does not support this feature, otherwise the system may not boot. Configuration options: [UC] [USWC]

### **Onboard PCI IDE Enable [Both]**

This field allows enable either the primary IDE channel or secondary IDE channel, or both. You can also set both channels to [Disabled]. Configuration options: [Both] [Primary] [Secondary] [Disabled]

### **Onboard ACR LAN Enable [Auto Detect]**

This field enables or disable the onboard Advanced Communication Riser (ACR) and Local Area Network (LAN) controller built-in the VT8233 chipset. Configuration options: [Enabled] [Auto Detect] [Disabled]

### **Onboard PCI Audio Enable [Enabled]**

This field enables PCI audio. Configuration options: [Enabled] [Disabled]

### **Memory Hole At 15M-16M [Disabled]**

This field reserves an address space for ISA expansion cards. Setting the address space to a particular setting makes that memory space unavailable to other system components. Expansion cards can only access memory up to 16MB. Configuration options: [Disabled] [Enabled]



# 4. BIOS SETUP

## 4.4.2 I/O Device Configuration

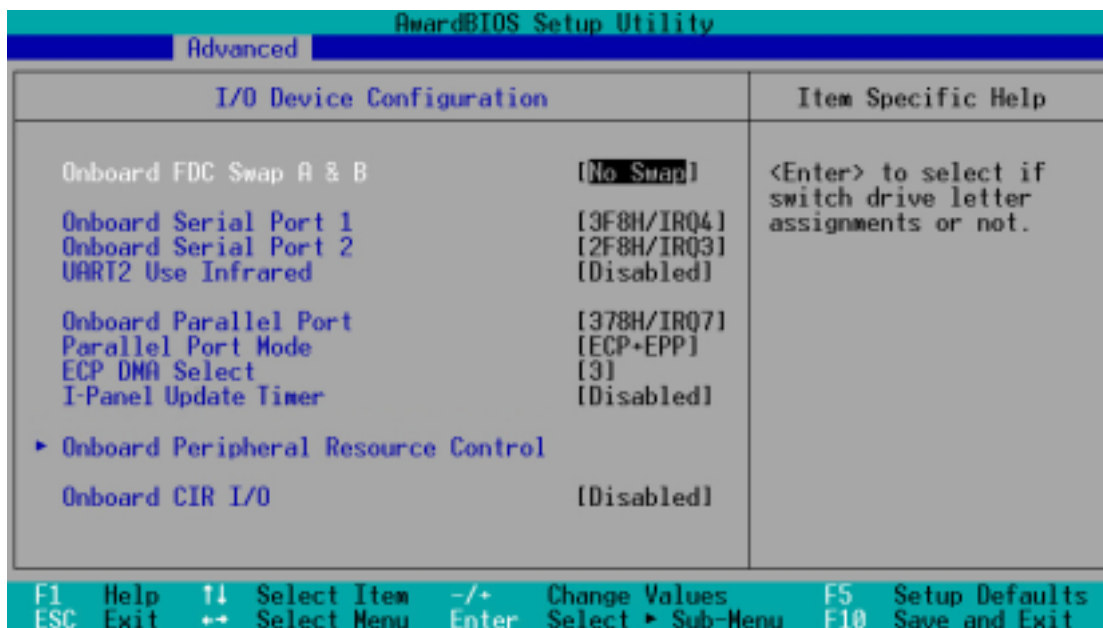

### Onboard FDC Swap A & B [No Swap]

This field allows you to reverse the hardware drive letter assignments of your floppy disk drives. Configuration options: [No Swap] [Swap AB]

### Onboard Serial Port 1 [3F8H/IRQ4]

### Onboard Serial Port 2 [2F8H/IRQ3]

These fields allow you to set the addresses for the onboard serial connectors. Serial Port 1 and Serial Port 2 must have different addresses. Configuration options: [3F8H/IRQ4] [2F8H/IRQ3] [3E8H/IRQ4] [2E8H/IRQ10] [Disabled]

### UART2 Use Standard Infrared [COM Port]

This field can activate the onboard standard infrared feature and sets the second serial UART to support the infrared module connector on the motherboard. It also may be used to configure another COM port or to support a serial smart card reader. See **IrDA-Compliant Infrared Module Connector** in **3.8 Connectors**. Configuration options: [COM Port] [IR] [Smart Card Reader]

### Onboard Parallel Port [378H/IRQ7]

This field sets the address of the onboard parallel port connector. If you disable this field, the **Parallel Port Mode** and **ECP DMA Select** configurations are not available. Configuration options: [Disabled] [378H/IRQ7] [278H/IRQ5]

# 4. BIOS SETUP

## Parallel Port Mode [ECP+EPP]

This field allows you to set the operation mode of the parallel port. [Normal] allows normal-speed operation but in one direction only; [EPP] allows bidirectional parallel port operation; [ECP] allows the parallel port to operate in bidirectional DMA mode; [ECP+EPP] allows normal speed operation in a two-way mode. Configuration options: [Normal] [EPP] [ECP] [ECP+EPP]

## ECP DMA Select [3]

This field allows you to configure the parallel port DMA channel for the selected **ECP** mode. This selection is available only if you select [ECP] or [ECP+EPP] in **Parallel Port Mode** above. Configuration options: [1] [3] [Disabled]

## I-Panel Update Timer [Disabled]

If you have the ASUS iPanel installed, and want the hardware monitoring function to be updated every 5 seconds, you may set this field to enable. I-Panel update timer. Configuration options: [Disable] [Enable]

## Onboard CIR I/O [Disabled]

This field allows you to select the I/O address and IRQ for consumer infrared device. Configuration options: [Disabled] [2E0-2E8H] [3E0-3E8H]

## Onboard Peripheral Resource Control

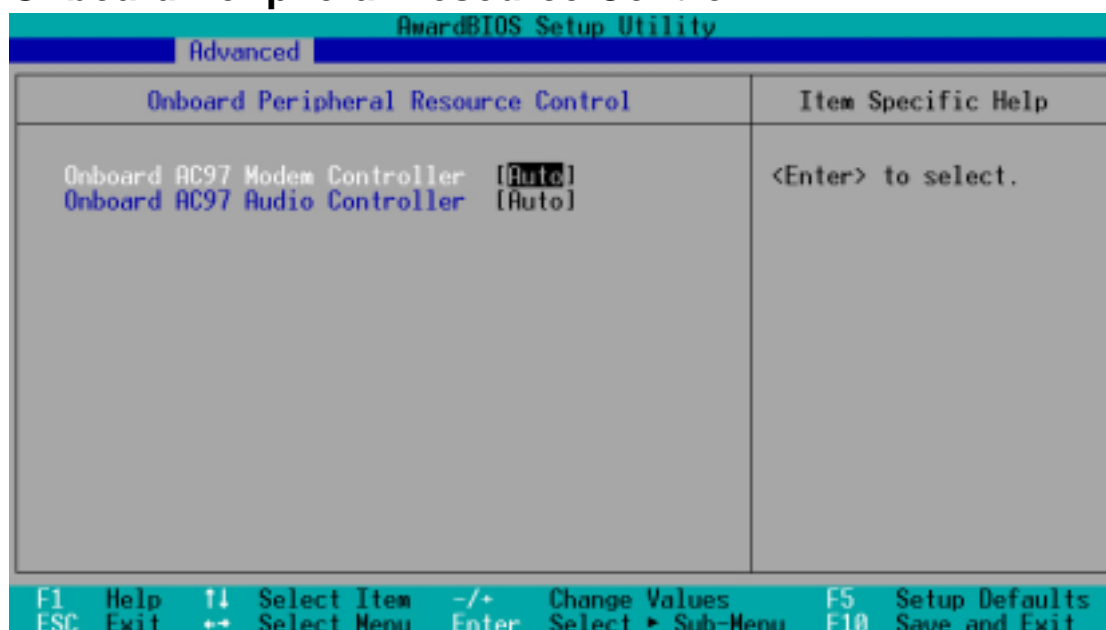

## Onboard AC97 Modem Controller [Auto]

## Onboard AC97 Audio Controller [Auto]

[Auto] allows the BIOS to detect whether you are using any modem/audio device. If a modem/audio device is detected, the onboard modem/audio controller is enabled; if no modem/audio device is detected, the controller is disabled. If there are conflicts with the onboard modem/audio controller, set the appropriate field to [Disabled]. Configuration options: [Disabled] [Auto]

# 4. BIOS SETUP

## 4.4.3 PCI Configuration

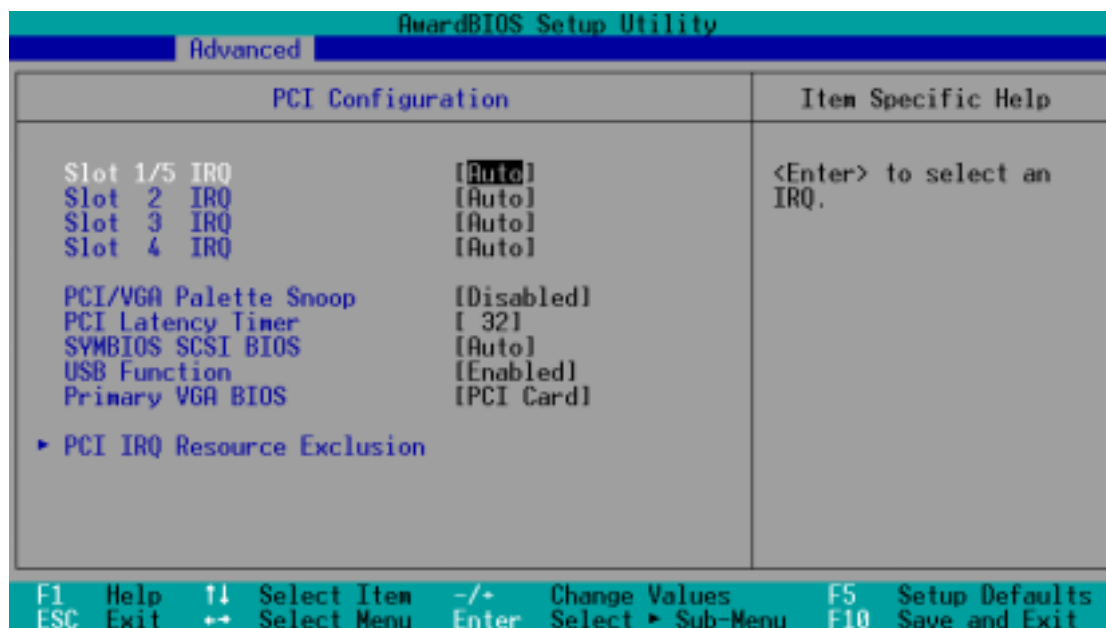

### Slot 1, Slot 2, Slot 3, Slot 4/5 IRQ [Auto]

These fields automatically assign the IRQ for each PCI slot. The default setting for each field is [Auto], which utilizes auto-routing to determine IRQ assignments. Configuration options: [Auto] [NA] [3] [4] [5] [7] [9] [10] [11] [12] [14] [15]

### PCI/VGA Palette Snoop [Disabled]

Some non-standard VGA cards, such as graphics accelerators or MPEG video cards, may not show colors properly. Setting this field to [Enabled] corrects this problem. If you are using standard VGA cards, leave this field to the default setting [Disabled]. Configuration options: [Disabled] [Enabled]

### PCI Latency Timer [32]

Leave this field to the default setting [32] for best performance and stability.

### SYMBIOS SCSI BIOS [Auto]

[Auto] allows the BIOS to detect whether you have a SYMBIOS SCSI card. If such card is detected, the SCSI BIOS is enabled. Otherwise, the onboard SCSI BIOS is disabled.

The setting [Disabled] disables the onboard SYMBIOS SCSI BIOS so that the BIOS on an add-on SYMBIOS SCSI card can be used. If the SYMBIOS SCSI card does not have a BIOS, the Symbios SCSI card will not work. Configuration options: [Auto] [Disabled]

# 4. BIOS SETUP

## USB Function [Enabled]

Set this field to [Enabled] if you want to use Universal Serial Bus (USB) devices. Configuration options: [Disabled] [Enabled]

## Primary VGA BIOS [PCI Card]

This field allows you to select the primary graphics card. Configuration options: [PCI Card] [AGP Card]

## PCI IRQ Resource Exclusion

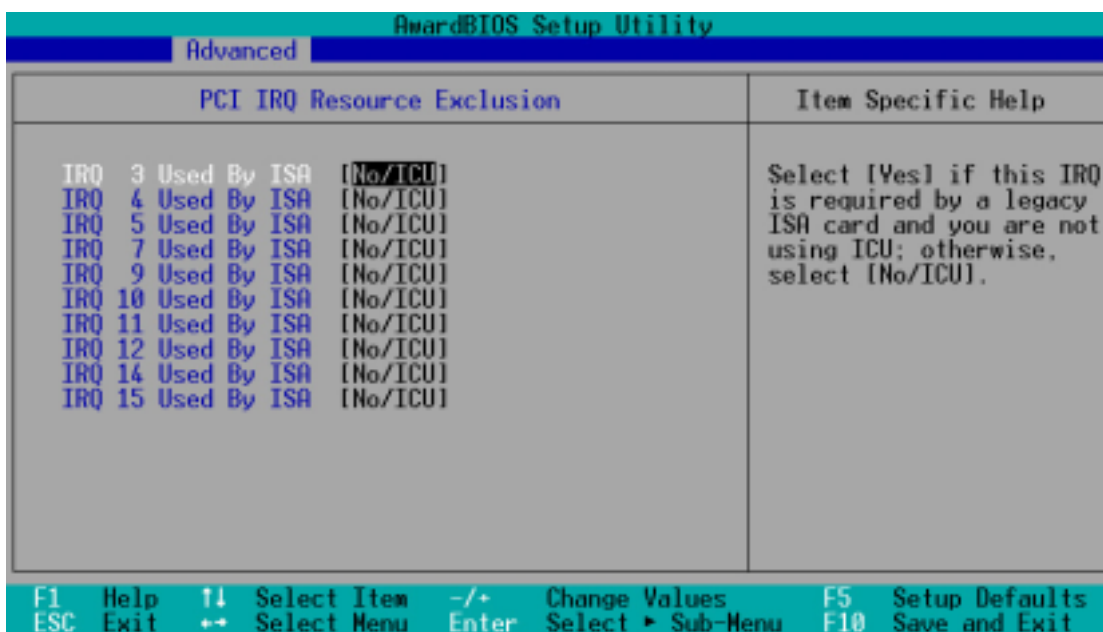

## IRQ XX Used By ISA [No/ICU]

These fields indicate whether or not the displayed IRQ for each field is being used by a legacy (non-PnP) ISA card. The setting [No/ICU] for an IRQ field indicates that you are using the ISA Configuration Utility (ICU), and that this particular IRQ is NOT required by a legacy ISA card. Set the IRQ field to [Yes] if you install a legacy ISA card that requires a unique IRQ and you are NOT using ICU. Configuration options: [No/ICU] [Yes]

# 4. BIOS SETUP

## 4.5 Power Menu

The Power menu allows you to reduce power consumption. This feature turns off the video display and shuts down the hard disk after a period of inactivity.

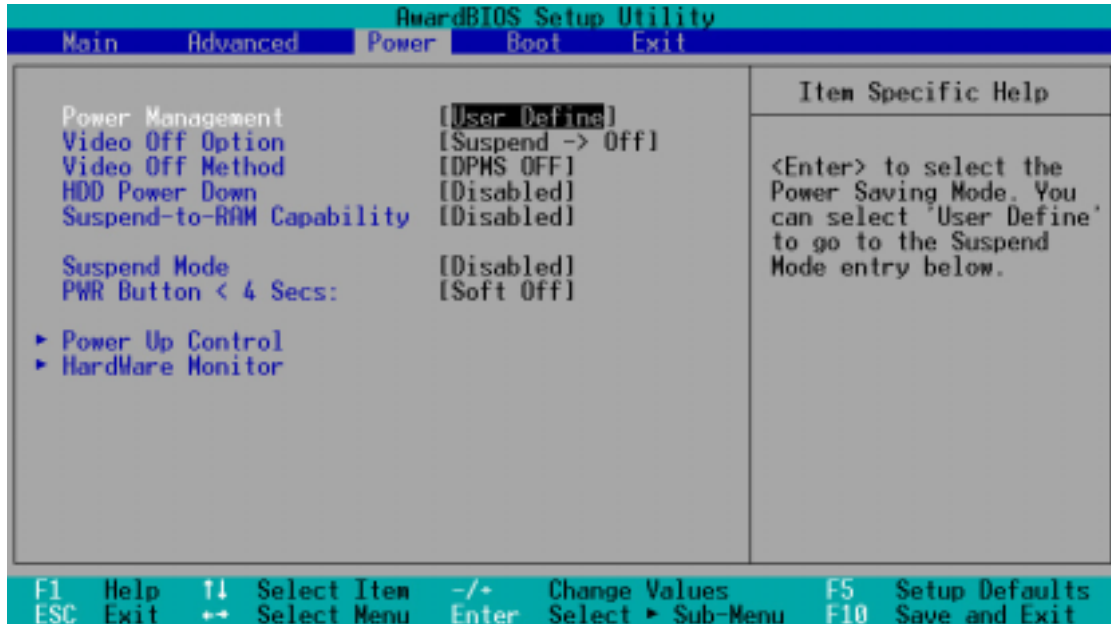

### Power Management [User Defined]

This field must be enabled to activate the automatic power saving features. When set to [Disabled], the power management features do not function regardless of the other settings on this menu. The [User Defined] option allows you to make your own selections in the Power menu. When set to [Max Saving], system power conserved to its greatest amount. The **Suspend Mode** field is then be set to a predefined value that ensures maximum power savings.

This field acts as the master control for the power management modes. [Max Saving] puts the system into power saving mode after a brief period of system inactivity. [Min Saving] is almost the same as [Max Saving] except that the system inactivity period is longer. [Disabled] deactivates the power saving features, [User Defined] allows you to set power saving options according to your preference. Configuration options: [User Defined] [Disabled] [Min Saving] [Max Saving]

**IMPORTANT:** You should install the Advanced Power Management (APM) utility to keep the system time updated even when the computer enters suspend mode. In DOS environment, you need to add the statement, DEVICE=C:\DOS\POWER.EXE, to the CONFIG.SYS file. In Windows 3.x and Windows 95, you need to install Windows with the APM feature. In Windows 98 or later, APM is automatically installed as indicated by a battery and power cord icon labeled “Power Management” in the “Control Panel.” Select the item “Advanced” in the Power Management Properties dialog box.

## 4. BIOS SETUP

---

### **Video Off Option [Suspend -> Off ]**

This field determines when to activate the video off feature for monitor power management. Configuration options: [Always On] [Suspend -> Off]

### **Video Off Method [DPMS OFF]**

This field defines the video off features. The DPMS (Display Power Management System) feature allows the BIOS to control the video display card if it supports the DPMS feature. [Blank Screen] only blanks the screen (use this for monitors without power management or “green” features. If set up in your system, your screen saver will not display with [Blank Screen] selected). [V/H SYNC+Blank] blanks the screen and turns off vertical and horizontal scanning. Configuration options: [Blank Screen] [V/H SYNC+Blank] [DPMS Standby] [DPMS Suspend] [DPMS OFF] [DPMS Reduce ON]

### **HDD Power Down [Disabled]**

Shuts down any IDE hard disk drives in the system after a period of inactivity as set in this user-configurable field. This feature does not affect SCSI hard drives. Configuration options: [Disabled] [1 Min] [2 Min] [3 Min]...[15 Min]

### **Suspend-to-RAM Capability [Disabled]**

This field lets you to enable or disable the Suspend-to-RAM (STR) feature allowing the system to go into suspend mode after the specified time in the Suspend Mode parameter. Configuration options: [Disabled] [enabled]

### **Suspend Mode [Disabled]**

Sets the time period before the system goes into suspend mode. Configuration options: [Disabled] [30 Sec] [1 Min] [2 Min]...[1 Hour]

### **PWR Button < 4 Secs [Soft Off]**

When set to [Soft off], the ATX switch can be used as a normal system power-off button when pressed for less than 4 seconds. [Suspend] allows the button to have a dual function where pressing less than 4 seconds will place the system in sleep mode. Regardless of the setting, holding the ATX switch for more than 4 seconds will power off the system. Configuration options: [Soft off] [Suspend]

# 4. BIOS SETUP

## 4.5.1 Power Up Control

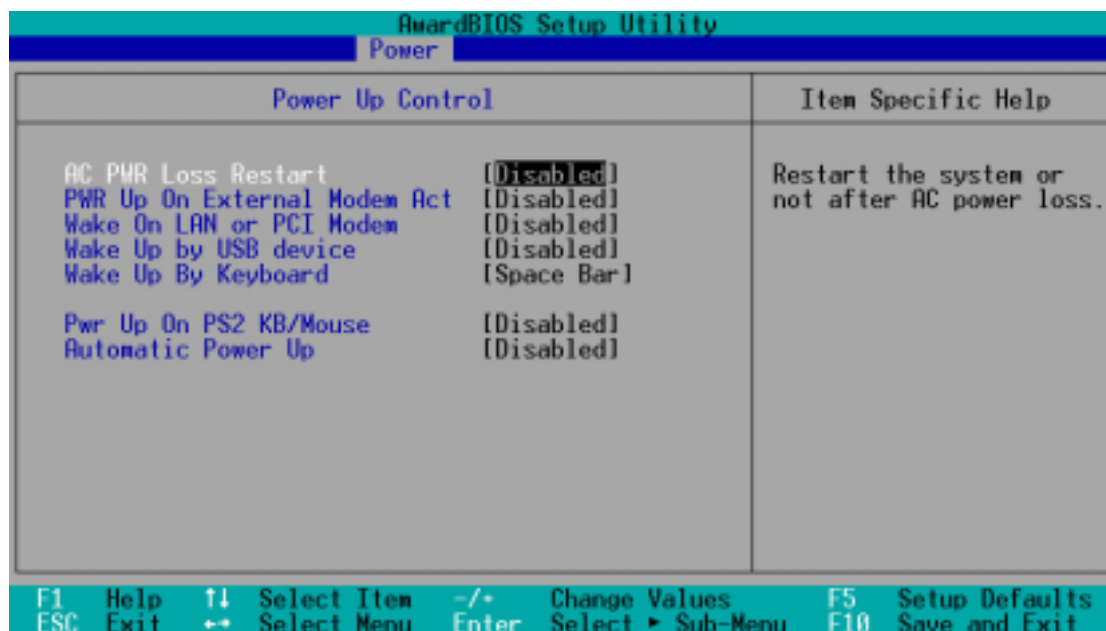

### AC PWR Loss Restart [Disabled]

This allows you to set whether you want your system to reboot after the power has been interrupted. [Disabled] leaves your system off and [Enabled] reboots your system. [Previous State] sets your system back to the state it is before the power interruption. Configuration options: [Disabled] [Enabled] [Previous State]

### PWR Up On External Modem Act [Disabled]

This allows either settings of [Enabled] or [Disabled] for powering up the computer when the external modem receives a call while the computer is in Soft-off mode. **NOTE:** The computer cannot receive or transmit data until the computer and applications are fully running. Thus connection cannot be made on the first try. Turning an external modem off and then back on while the computer is off causes an initialization string that will also cause the system to power on. Configuration options: [Disabled] [Enabled]

### Wake On LAN or PCI Modem [Disabled]

Wake-On-LAN/PCI Modem allows your computer to be booted from another computer via a network by sending a wake-up frame or signal. Configuration options: [Disabled] [Enabled]

**IMPORTANT:** This feature requires an optional network interface with Wake-On-LAN and an ATX power supply with at least 720mA +5V standby power.

## 4. BIOS SETUP

---

### **Wake Up by USB Device [Disabled]**

When set to [Enabled], this field allows you to wake up the system by a USB device activity. This feature requires an ATX power supply that can supply at least 1A on the +5VSB lead. The default is [Disabled] because not all computer have the appropriate power supply. A computer without the correct power supply will power up if you set this field to [Enabled]. Configuration options: [Disabled] [Enabled]

### **Wake Up by Keyboard [Space Bar]**

This parameter allows you to use specific keys on the keyboard to power up the computer. Configuration options: [Space Bar] [Ctrl-Esc] [Power Key]

### **Power Up on PS2 KB/Mouse [Disabled]**

Set this field to [Enabled] if you want to use your PS/2 keyboard or PS/2 mouse to power up the computer. This feature requires an ATX power supply that can supply at least 300mA on the +5VSB lead. The default is [Disabled] because not all computer have the appropriate power supply. Configuration options: [Disabled] [Enabled]

### **Automatic Power Up [Disabled]**

This allows an unattended or automatic system power up. You may configure your system to power up at a certain time of the day by selecting [Everyday] or at a certain time and day by selecting [By Date]. Configuration options: [Disabled] [Everyday] [By Date]



# 4. BIOS SETUP

## 4.5.2 Hardware Monitor

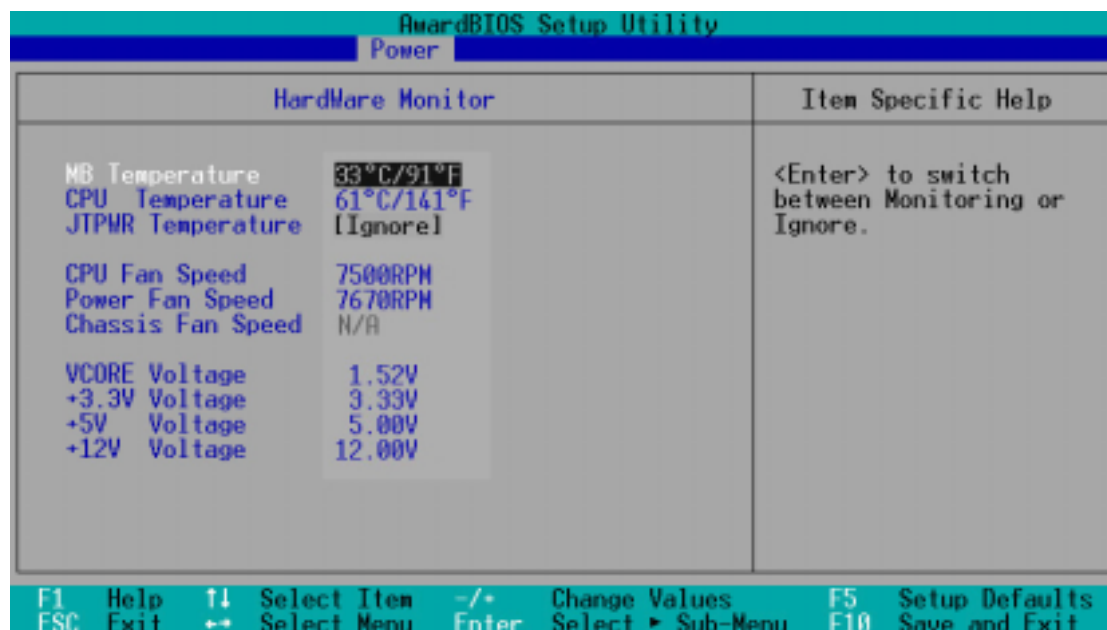

### MB Temperature [xxxC/xxxF]

### CPU1/CPU2 Temperature [xxxC/xxxF]

### JTPWR Temperature [xxxC/xxxF]

The onboard hardware monitor automatically detects the MB (motherboard), CPU, and JTPWR (power supply) temperatures.

### CPU Fan Speed [xxxxRPM]

### Power Fan Speed [xxxxRPM]

### Chassis Fan Speed [N/A]

The onboard hardware monitor automatically detects the speeds of the CPU fan, chassis fan, and chassis fan measured in rotations per minute (RPM).

### Vcore1/Vcore2 Voltage

### +3.3V Voltage, +5V Voltage, +12V Voltage

The onboard hardware monitor automatically detects the voltage output through the onboard voltage regulators.

**NOTE:** If any of the monitored items is out of range, the following error message appears: “Hardware Monitor found an error. Enter Power setup menu for details”. You will then be prompted to “Press **F1** to continue or **DEL** to enter SETUP”.

# 4. BIOS SETUP

## 4.6 Boot Menu

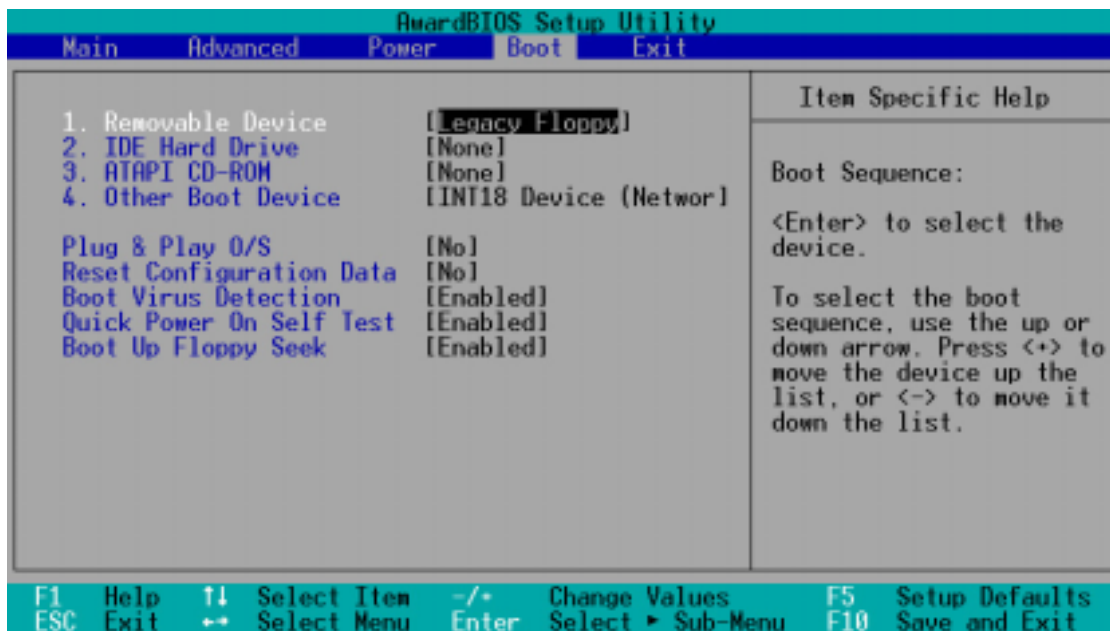

### Boot Sequence

The Boot menu allows you to select among the four possible types of boot devices listed using the up and down arrow keys. By using the <+> or <Space> key, you can promote devices and by using the <-> key, you can demote devices. Promotion or demotion of devices alters the priority which the system uses to search for a boot device on system power up. Configuration fields include **Removable Devices**, **IDE Hard Drive**, **ATAPI CD-ROM**, and **Other Boot Device**.

#### Removable Device [Legacy Floppy]

Configuration options: [Disabled] [Legacy Floppy] [LS120] [ZIP] [ATAPI MO]

#### IDE Hard Drive

This field allows you to select which IDE hard disk drive to use in the boot sequence. Pressing [Enter] will show the product IDs of all connected IDE hard disk drives.

#### ATAPI CD-ROM

This field allows you to select which ATAPI CD-ROM drive to use in the boot sequence. Pressing [Enter] will show the product IDs of all your connected ATAPI CD-ROM drives.

#### Other Boot Device Select [INT18 Device (Network)]

Configuration options: [Disabled] [SCSI Boot Device] [INT18 Device (Network)]

## 4. BIOS SETUP

---

### **Plug & Play O/S [No]**

This field allows you to use a Plug-and-Play (PnP) operating system to configure the PCI bus slots instead of using the BIOS. When [Yes] is selected, interrupts may be reassigned by the OS. When a non-PnP OS is installed or you want to prevent reassigning of interrupt settings, select the default setting of [No]. Configuration options: [No] [Yes]

### **Reset Configuration Data [No]**

The Extended System Configuration Data (ESCD) contain information about non-PnP devices. It can also hold the complete record of how the system was configured the last time it was booted. Select [Yes] only if you want to clear these data during the Power-On Self Test (POST). Configuration options: [No] [Yes]

### **Boot Virus Detection [Enabled]**

This field allows you to set boot virus detection, ensuring a virus-free boot sector. The system halts and displays a warning message when it detects a virus. If this occurs, you can either allow the operation to continue or use a virus-free bootable floppy disk to restart and investigate your system. Configuration options: [Disabled] [Enabled]

### **Quick Power On Self Test [Enabled]**

This field speeds up the Power-On-Self Test (POST) routine by skipping retesting a second, third, and fourth time. Configuration options: [Disabled] [Enabled]

### **Boot Up Floppy Seek [Enabled]**

When enabled, the BIOS will seek the floppy disk drive to determine whether the drive has 40 or 80 tracks. Configuration options: [Disabled] [Enabled]

# 4. BIOS SETUP

## 4.7 Exit Menu

When you have made all of your selections from the various menus in the Setup program, save your changes and exit Setup. Select **Exit** from the menu bar to display the following menu:

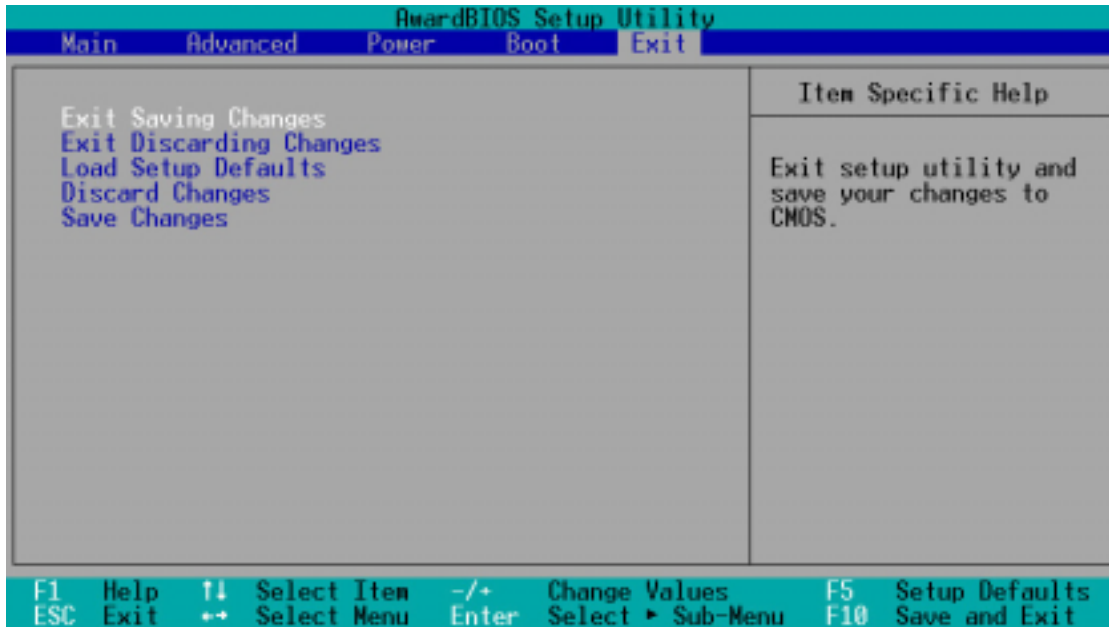

**NOTE:** Pressing <Esc> does not immediately exit this menu. Select one of the options from this menu or <F10> from the legend bar to exit this menu.

### Exit Saving Changes

Once you are finished making your selections, choose this option from the Exit menu to ensure the values you selected are saved to the CMOS RAM. The CMOS RAM is sustained by an onboard backup battery and stays on even when the PC is turned off. When you select this option, a confirmation window appears. Select [Yes] to save changes and exit.

**NOTE:** If you attempt to exit the Setup program without saving your changes, the program prompts you with a message asking if you want to save your changes before exiting. Pressing <Enter> saves the changes while exiting.

### Exit Discarding Changes

Select this option only if you do not want to save the changes that you made to the Setup program. If you made changes to fields other than system date, system time, and password, the BIOS asks for a confirmation before exiting.

# 4. BIOS SETUP

---

## **Load Setup Defaults**

This option allows you to load the default values for each of the parameters on the Setup menus. When you select this option or if you press <F5>, a confirmation window appears. Select [Yes] to load default values. Select **Exit Saving Changes** or make other changes before saving the values to the non-volatile RAM.

## **Discard Changes**

This option allows you to discard the selections you made and restore the previously saved values. After selecting this option, a confirmation appears. Select [Yes] to discard any changes and load the previously saved values.

## **Save Changes**

This option saves your selections without exiting the Setup program. You can then return to other menus and make further changes. After you select this option, a confirmation window appears. Select [Yes] to save any changes to the non-volatile RAM.

## 4. BIOS SETUP

---

*(This page was intentionally left blank.)*

# 5. SOFTWARE SETUP

---

## 5.1 Install Operating System

You should always use the latest operating system and updates when using new hardware to ensure full compliancy. You may use any version of Windows 98/2000/Millennium, but for Windows 95, you must use OSR 2.0 or later. For Windows NT 4.0, you must use Service Pack 3.0 or later.

## 5.2 Start Windows

When you start Windows for the first time after installing your motherboard, Windows will detect all plug-and play devices. Follow the Add New Hardware Wizard to install all necessary device drivers. When prompted to restart, select **No** and then follow the setup procedures in this section.

**NOTE:** Because there are various motherboard settings, options, and expansion cards, the following can only be used as a general reference and may not reflect exactly the screen contents displayed on your screen.

# 5. SOFTWARE SETUP

## 5.3 A7V266 Series Motherboard Support CD

**NOTE:** The support CD contents are subject to change at any time without notice.

To begin using your support CD disc, just insert it into your CD-ROM drive and the support CD installation menu should appear. If the menu does not appear, double-click or run **D:\ASSETUP.EXE** (assuming that your CD-ROM drive is drive **D:**).

### 5.3.1 Installation Menu



- **VIA 4 in 1 drivers:** Installs Bus Master PCI IDE Driver, AGP VxD Driver, VIA Chipset Functions Registry, and IRQ Routing Miniport Driver.
- **C-Media PCI Audio Driver and Application:** Installs the drivers for the C-Media Audio Driver and its program applications to set-up multi-channel audio features.
- **Windbond Smart Manager Application:** Installs the Smart Manager program, base components and drivers to read smart cards for system security and file encryption.
- **ASUS PC Probe Vx.xx:** Installs a smart utility to monitor your computer's fan, temperature, and voltages.
- **ASUS Update Vx.xx:** Installs a program that can help you update BIOS or download a BIOS image file.
- **Microsoft DirectX Driver:** Installs basic drivers to enable compatibility with audio and other special functions.
- **PC-Cillin 2000 Vx.xx:** Installs the PC-cillin virus protection software. View online help for more information.
- **ADOBE Acrobat Reader Vx.xx:** Installs the Adobe Acrobat Reader software necessary to view user's manuals saved in PDF format. Updated or other language versions of this motherboard's manual is available in PDF format at any of our web sites.
- **Cyberlink Video and Audio Applications:** Installs Cyberlink PowerPlayer SE, PowerDVD Trial, and Cyberlink VideoLive Mail.
- **ASUS Screen Saver:** Installs a nifty ASUS screen saver.

(TO SEE THE FOLLOWING ITEMS, CLICK RIGHT ARROW ON THE LOWER-RIGHT CORNER OF THE MAIN MENU)



## 5. SOFTWARE SETUP

---

- **E-Color 3Deep:** Installs graphical driver and an application for tuning the quality of color output from CRT and LCD monitors.
- **Show Motherboard Information:** Allows you to view information about your motherboard, such as product name, BIOS version, and CPU.
- **Browse Support CD:** Allows you to view the contents of the CD.
- **ReadMe:** Allows you to view the support CD file list and contact information.
- **Exit:** Exits the CD installation menu.

( RETURN TO THE MAIN MENU, CLICK LEFT ARROW ON THE LOWER-RIGHT CORNER )

# 5. SOFTWARE SETUP

---

(This page was intentionally left blank.)

# 6. SOFTWARE REFERENCE

## 6.1 Winbond Smart Manager

The *Winbond Smart Manager* is a clever utility that helps secure the PC with a *Read2-IN-01 Smart Card Reader* (see page 7) and a smart card containing a mini-chip insert, like a *GSM cell phone SIM card*. Once a smart card reader is configured, set up the *Smart Manager* software utility for “boot up” or “always on” system security.

### 6.1.1 Setting Up Smart Manager

**Connect** the *smart card reader* to the A7V266; (refer to *Section 3.8.13 in Hardware Setup* for the *connector* location.) **Boot up** the PC and enter **BIOS** (press <del>) to change the configuration to accept smart card hardware: in the *Advanced BIOS* menu select the *I/O Device Configuration* sub-menu, go to *UART2* and select **Smart Card Read**, save and exit.

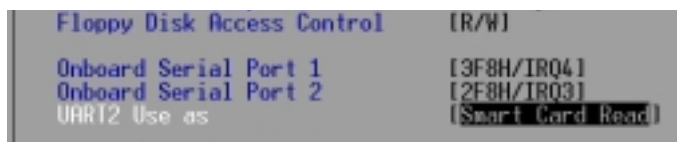

Finish booting up. Insert the ASUS Support CD and click on the selection: *Winbond Smart Manager Application*. The auto-installer prompts to install the *Base Components* and after doing show displays a *readme* file. Next, immediately install the *Smart Card Driver Library* as prompted. Finally, install the *Winbond Smart Manager* application as prompted.

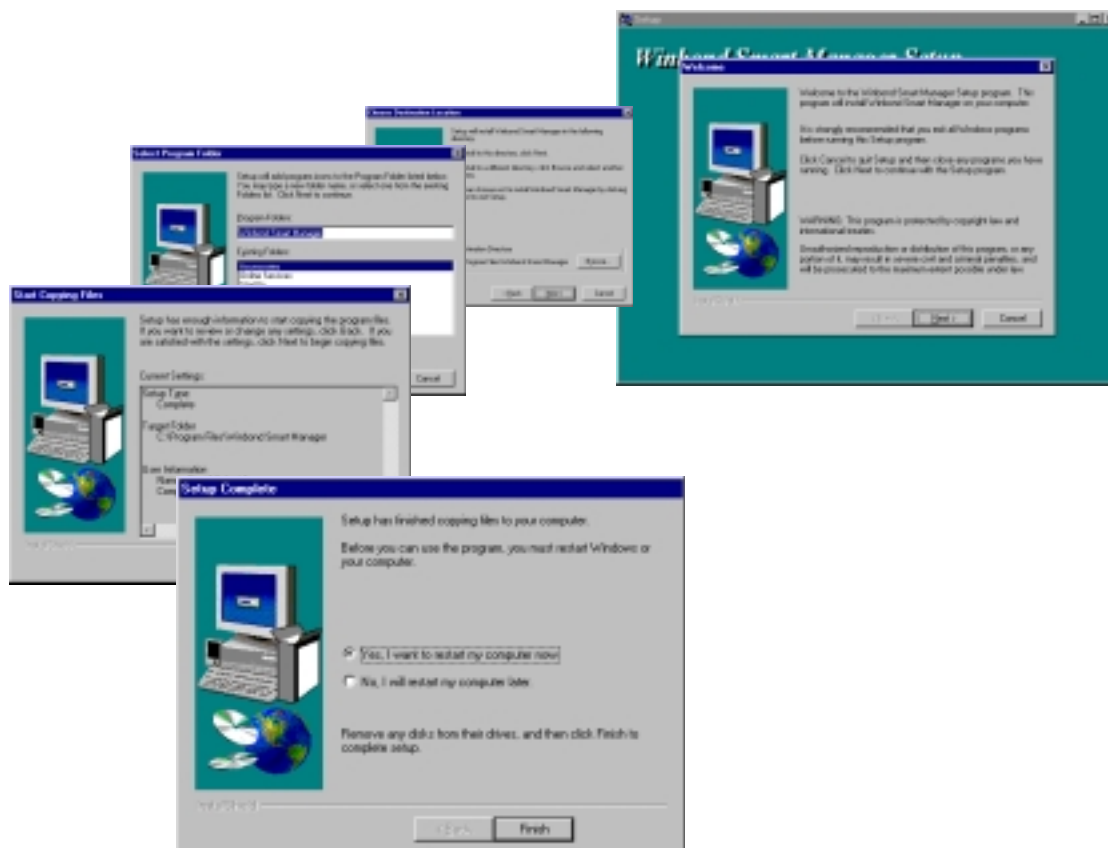

## 6. SOFTWARE REFERENCE

The auto-installer implements all of the drivers, base components and displays the *Winbond Smart Manager* program groups. **Restart.** *Windows* should auto-detect the *smart card reader* and install its system drivers.



**NOTE:** Do not install system components or *Winbond* applications *unless* you install a smart card *reader*, (see page 7). Smart card system software components support various types of smart card applications; all system components are compatible with *Windows 98, ME* and *2000*. However, the *Winbond Smart Manager* application is readily compatible *only* with *Windows 98* and *ME*.

# 6. SOFTWARE REFERENCE

## 6.1.2 Starting to Use Smart Manager

After installing the software, start *Windbond Smart Manager* for the first time: select the **Programs** menu from the **Start** bar and select the **Windbond** program group. When you click the program application, an **icon** is created for the **Logon Smart Card** software in the bottom right hand corner of the screen.

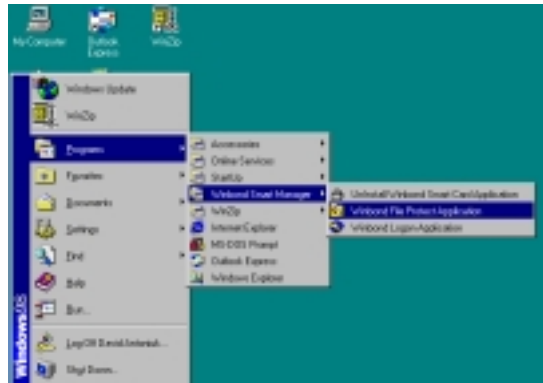

The new **icon** resembles a key.

**Right click** on the icon and select **Setting Logon Smart Card**.

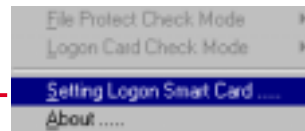

Click the **Add New** button and then select the type of card you are using. Insert the **smart card** into the card reader, then enter your name and any remarks into the fields. Click **OK**.

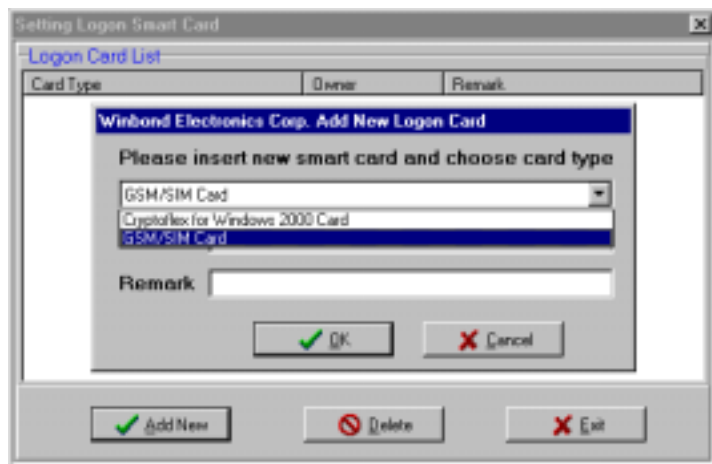

The card reader detects the smart card ID. *Smart Manager* registers the smart card for security capability and prompts to click **OK**. The card's **security status** is displayed in the main program window.

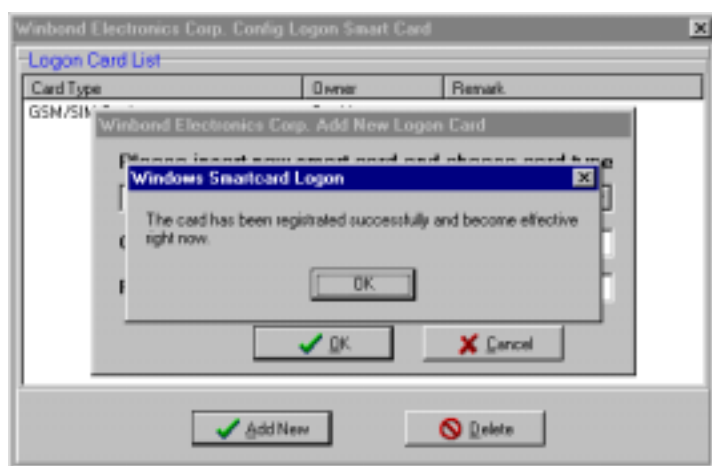

## 6. SOFTWARE REFERENCE

### 6.1.3 Smart Manager Modes

Return to the *Windbond Smart Manager* icon on the bottom right hand corner of the *Windows* screen. Select the **Logon Card Check Mode** to choose the security mode. Three basic modes are available:

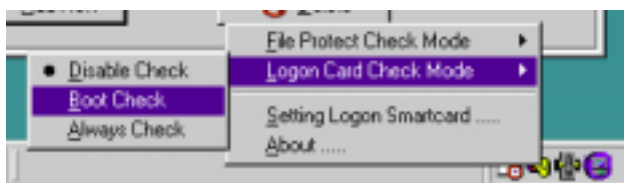

1. **Disable Check** renders the *Smart Manager* security system inoperative.
2. **Boot Check** enables the *Smart Manager* security system for start up. The user must insert the smart card into the reader during start up in order to complete the *Windows* boot up process. In this mode, the user may remove the smart card and continue to use the PC after the start cycle is complete. If no smart card, or the wrong one, is inserted during boot up, the PC displays the *Smart Manager Protection Screen*:

Whenever the *Smart Manager Protection Screen* is displayed, the computer is secured and impenetrable.



3. **Always Check** configures the *Smart Manager* to require that the user insert the smart card during start up; then, if the card is removed at any time during the operation of the PC, the *Smart Manager* protection screen will automatically pop up and the PC is secure until the card is reinserted.

**File Protect Check Mode:** This is a sub-program used to encrypt and decode individual files stored in the system using a smart card as a key.

**NOTE:** Do take care **not to lose** your smart card or you may not be able to restart the PC or decode encrypted files. Test each new smart card to ensure that it is completely compatible with the card reader; the *Read2-In-01 Smart Card Reader* is designed only to read cards with the standard PC/SC mini-chip configuration.

# 6. SOFTWARE REFERENCE

## 6.2 ASUS PC Probe

ASUS PC Probe is a convenient utility to continuously monitor your computer system's vital components, such as fan rotations, Voltages, and temperatures. It also has a utility that lets you review useful information about your computer, such as hard disk space, memory usage, and CPU type, CPU speed, and internal/external frequencies through the DMI Explorer.

### 6.2.1 Starting ASUS PC Probe

When ASUS PC Probe starts, a splash screen appears allowing you to select whether or not to show the screen the next time you open PC Probe. To bypass this startup screen, clear the **Show up in next execution** check box.

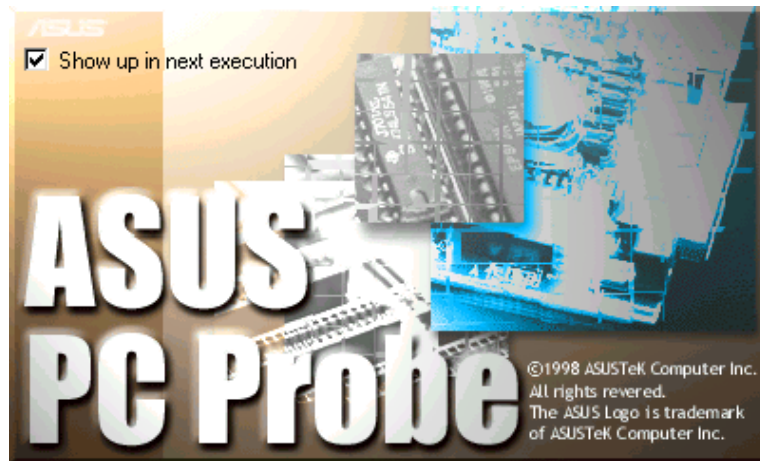

To start **ASUS PC Probe**, click the Windows **Start** button, point to **Programs**, and then **ASUS Utility**, and then click **Probe Vx.xx**.

The PC Probe icon  will appear on the taskbar's system tray indicating that ASUS PC Probe is running. Clicking the icon will allow you to see the status of your PC.

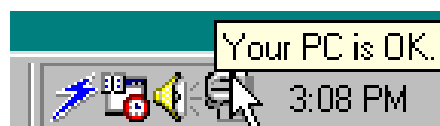



# 6. SOFTWARE REFERENCE

## 6.2.2 Using ASUS PC Probe Monitoring

### Monitor Summary

Shows a summary of the items being monitored.



### Temperature Monitor

Shows the PC's temperature.

Temperature Warning threshold adjustment  
(Move the slider up to increase the threshold level or down to decrease the threshold level)



### Fan Monitor

Shows the PC's fan rotation.

Fan Warning threshold adjustment  
(Move the slider up to increase the threshold level or down to decrease the threshold level)

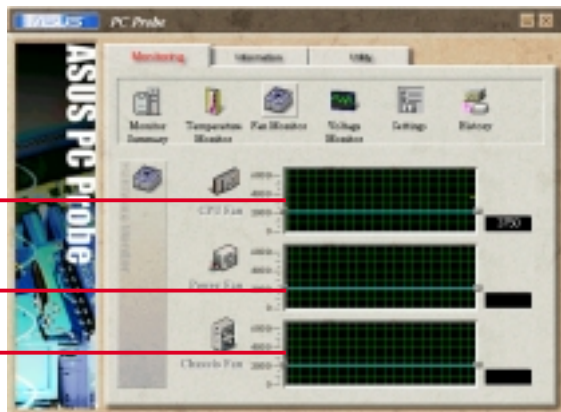

### Voltage Monitor

Shows the PC's voltages.

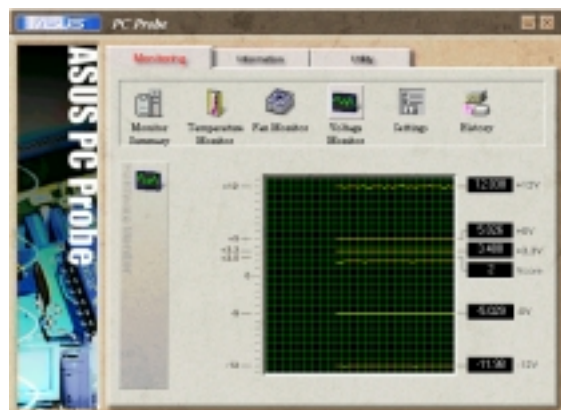



# 6. SOFTWARE REFERENCE

## Settings

Lets you set threshold levels and polling intervals or refresh times of the PC's temperature, fan rotation, and voltages.



## CPU Cooling System Setup

Lets you select when to enable software CPU cooling. When **When CPU Overheated** is selected, the CPU cooling system is enabled whenever the CPU temperature reaches the threshold value.

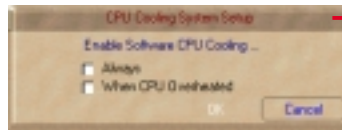

## History

Lets you record the current monitoring activity of a certain component of your PC for future reference.



## Information

### Hard Drives

Shows the used and free space of the PC's hard disk drives and the file allocation table or file system used.



# 6. SOFTWARE REFERENCE

## Memory

Shows the PC's memory load, memory usage, and paging file usage.



## Device Summary

Shows a summary of devices in your PC.



## DMI Explorer

Shows information pertinent to the PC, such as CPU type, CPU speed, and internal/external frequencies, and memory size.



## Utility

Lets you run programs outside of the ASUS Probe modules. To run a program, click **Execute Program**.



# 6. SOFTWARE REFERENCE

## 6.2.3 ASUS PC Probe Task Bar Icon

Right-clicking the PC Probe icon will bring up a menu to open or exit ASUS PC Probe and pause or resume all system monitoring.



When the ASUS PC Probe senses a problem with your PC, portions of the ASUS PC Probe icon changes to red, the PC speaker beeps, and the ASUS PC Probe monitor is displayed.

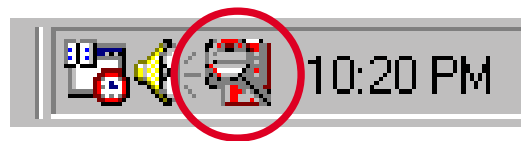

## 6. SOFTWARE REFERENCE

### 6.3 Multi-Channel Audio Feature Setup

The C-Media PCI Audio Driver and Applications are located on the Support CD. Installing the programs enables the multi-channel audio feature. **Note:** You must use 4 or 6 channel speakers for this setup.

#### 6.3.1 The C-Media Audio Mixer

##### 1. The C-Media Mixer

**Icon** appears on the bottom right of the screen, or the **Mixer** may be turned on from the **PCI Audio Applications & Audio Rack** groups on the **Main Program** menu using the Windows **Start** button:  Click on the **icon** to display the C-Media **Audio Mixer**:

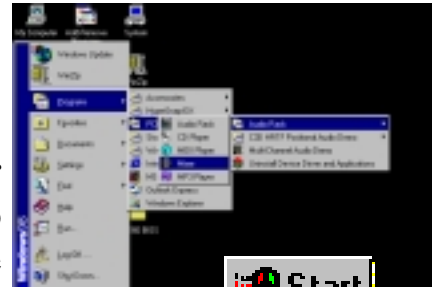

2. The **Advanced** button activates the **Speaker, Volume, Sound Effects** and **Options** menus. The **Speaker** menu offers various configurations for your speaker system. This menu enables the **Line-In** and **Mic-In audio jacks** on the back panel to setup additional speakers for 4 and 6-Channel Audio.



#### 6.3.2 The C-Media Audio Demo Program

1. The Audio Demo program offers an easy way to test and tune your new speaker system. Activate the **Multi-Channel Audio Demo** program from the **PCI Audio Applications** group on the **Main Program** menu using the Windows **Start** button:

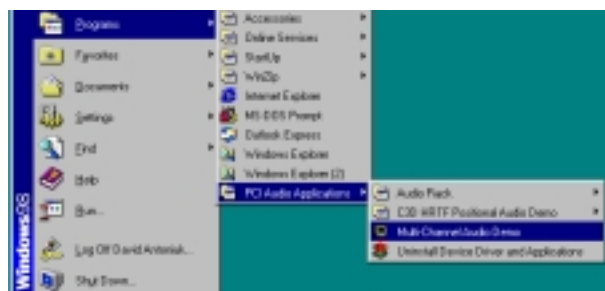

## 6. SOFTWARE REFERENCE

2. The **PCI Multi-Channel Audio Demo** has several **Demos** to help fine tune your PC speaker system. The **Help** menu features several pages of instructions and hardware diagrams to help configure and test the system. To activate the **Speaker Channel Configuration Menu**, point your mouse arrow and click on the **TV box**.



3. The **Speaker Channel Configuration Menu** displays all the options available to help tune the multi-channel audio system even more precisely.

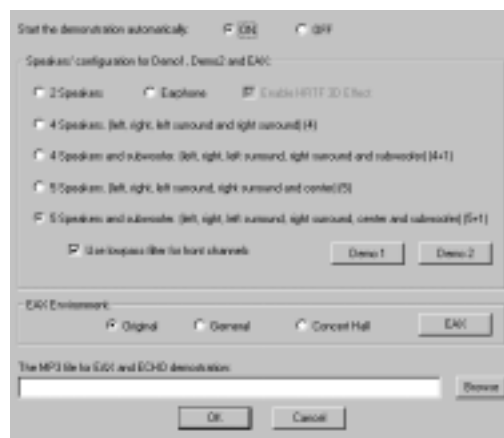

### 6.3.3 Connector Configuration

The **chart** below displays the configurations for the line connectors on the yellow MIDI/Game/Audio connector port located on the back panel. The three female connectors are available for use in the 6-Channel audio system.

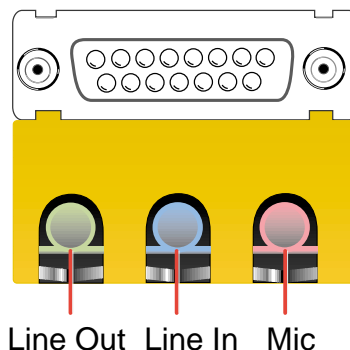

### Connector Settings and Functions

	Headphone/ 2-Speaker	4-Speaker	6-Speaker
Lime	Line Out/ Front Spkr Out	Line Out/ Front Spkr Out	Line Out/ Front Spkr Out
Light Blue	Line In	Rear Speaker Out	Rear Speaker Out
Pink	Mic In	Mic In	Center Speaker Out, Sub-woofer

**Note:** See 7 in Section 3, *Motherboard settings* for the Bass/Center Jumper settings to fine tune the output signals.



# 6. SOFTWARE REFERENCE

## 6.4 ASUS LiveUpdate

ASUS LiveUpdate is a utility that allows you to update your motherboard's BIOS and drivers. The use of this utility requires that you are properly connected to the Internet through an **Internet Service Provider (ISP)**.

1. Start ASUS Update.

Launch the utility from **Start | Programs | ASUS Utility | ASUS LiveUpdate**.

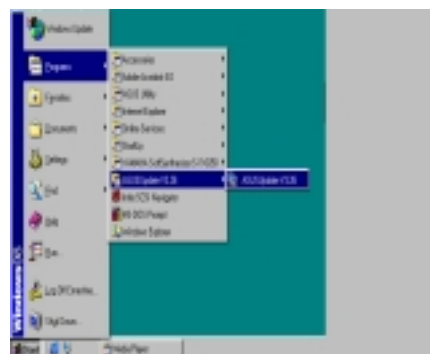

2. Select an update method.



3. If you selected updating/downloading from the Internet, you will need to select an Internet site. Choose the site that is closest to you or click **Auto Select**.



If you selected **Update from a file**, you will be prompted to locate the file.



## 6. SOFTWARE REFERENCE

### 6.5 3Deep Color Tuner

The 3-Deep color tuner is designed to match your CRT or LCD color monitor to maximize the color quality of all graphical applications. Users may also tune their internet applications to match “true” internet source colors with the color displayed on the monitor.

Simply run the setup program from the start menu and follow the instructions on the various setup/test screens.

#### 6.5.1 3Deep Color Tuning

1. Select the type of monitor connected to the computer, either **CRT** or **LCD**.



2. Follow the instructions to manually adjust the **brightness** level of the monitor.



3. Select the faintest of the three colors: **blue**, **red** and **green**.



## 6. SOFTWARE REFERENCE

4. Select the color squares which most closely blend and match with the background.
5. The next step repeats the color matching process to achieve full color quality.

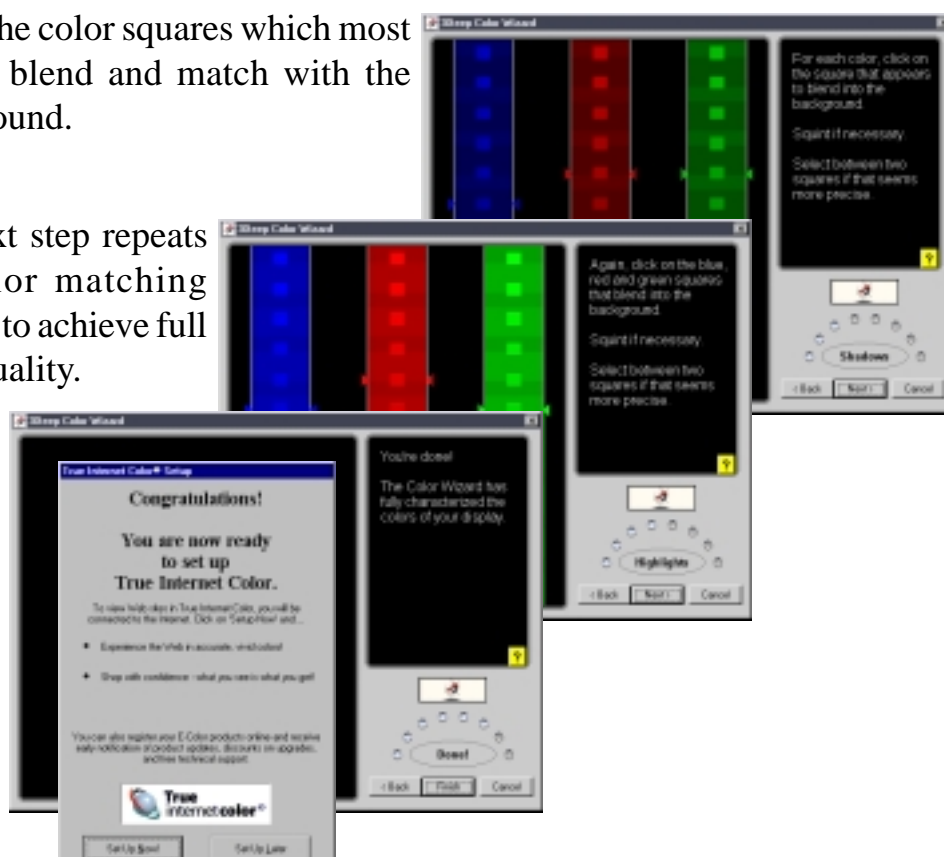

6. The tuning process is complete. Click on the bottom left button to connect to the internet and follow the instructions.

### 6.5.2 The 3Deep Control Panel

Using the Windows **Start button**, activate the **3Deep Control Panel** program from the **3Deep Applications** group on the **Main Program** menu. The control panel offers access to the **Color Wizard** tuning program, a **Game Gamma** setting and a **Tweak** slider for brightness adjustment.

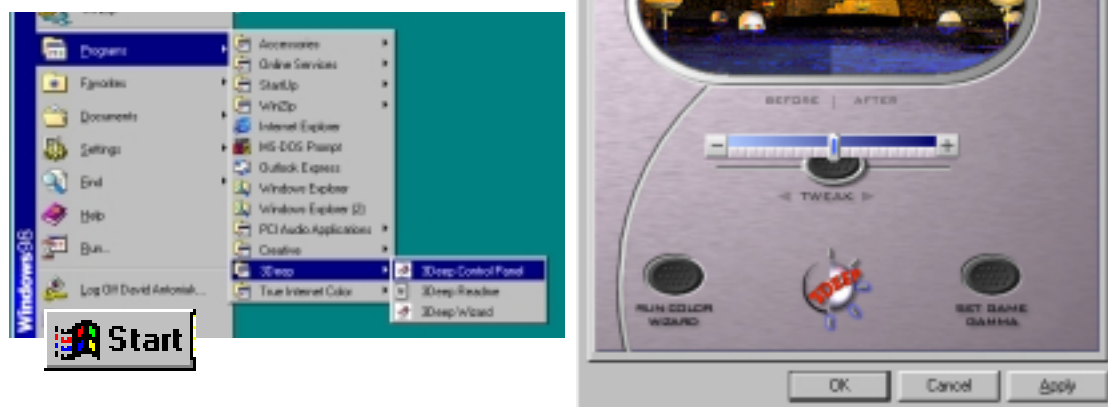



# 6. SOFTWARE REFERENCE

## 6.6 CyberLink PowerPlayer SE

CyberLink PowerPlayer SE is an intelligent software player that can automatically detect and playback all kinds of video/audio files, CD and MP3 files as well. This is the only software you need for all types of video and audio files. No need to waste time identifying your file types.

### 6.6.1 Starting CyberLink PowerPlayer SE

To start **CyberLink Power Player**, click the Windows **Start** button, point to **Programs**, and then **CyberLink PowerPlayer SE**, and then click **PowerPlayer**.

### 6.6.2 CyberLink PowerPlayer Control Panel

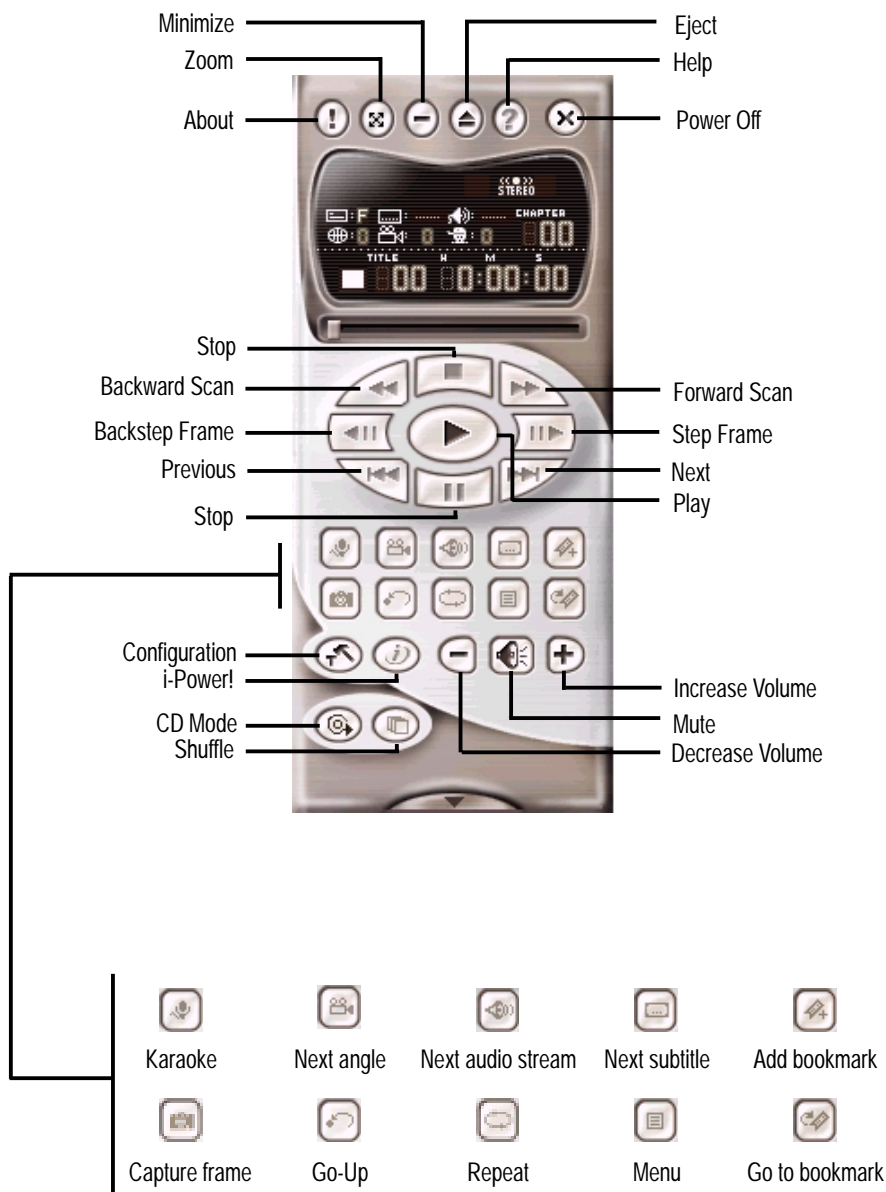

## 6. SOFTWARE REFERENCE

### 6.7 CyberLink PowerDVD

CyberLink PowerDVD is the flagship of CyberLink's complete range of video and audio software products. It features unrivaled functions allowing users to view high quality video and media-rich DVD contents on the personal computer. With the i-Power Internet Enabling feature, PowerDVD opens DVD enthusiasts to on-line DVD resources via the PowerDVD Desktop Portal Page.

#### 6.7.1 Starting CyberLink PowerDVD

To start **CyberLink PowerDVD**, click the Windows **Start** button, point to **Programs**, and then **CyberLink PowerDVD**, and then click **PowerDVD**.

#### 6.7.2 CyberLink PowerDVD User Interface

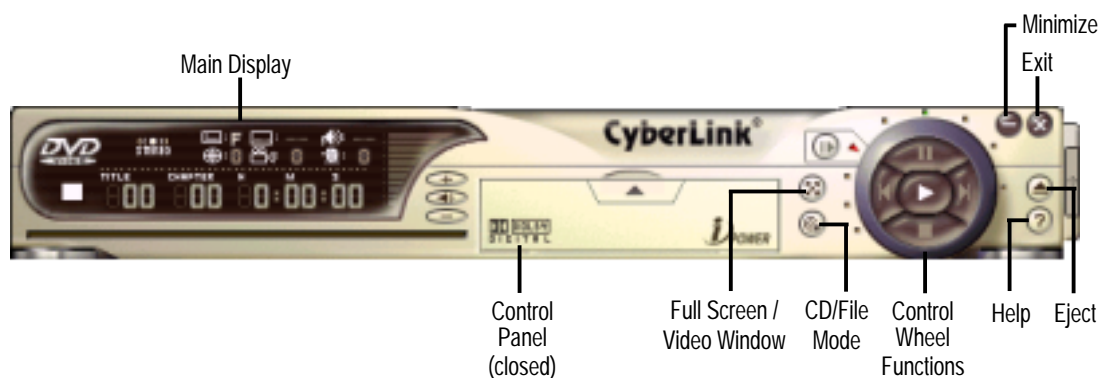

## 6. SOFTWARE REFERENCE

---

### 6.8 CyberLink VideoLive Mail

CyberLink's VideoLive Mail Plus Ver 3.0 (a.k.a. VLM 3) is a convenient and excellent way to create professional quality video mails from PC video/audio input devices and to send the mails to any recipients via VLM 3's built-in e-mail system through the Internet. VLM 3's mails comprise video, sound, or snapshot information; and thus may convey the most profound information to target audiences. It is very convenient for mail recipients who do not need to install additional software component in order to view VLM 3 mails.

VLM 3 works as a very applicant sales tool. It efficiently delivers profound and live product information to your target customers without costing a fortune. VLM 3 also helps corporate managers easily give vivid speeches and broadcast through corporate E-mail system. For personal or home users, VLM 3 easily records live video clips allowing users to send them to friends or family members across the Internet.

VLM 3 loads video messages from PC cameras, digital camcorders, analog camcorder via video capture cards, or from an existing AVI video clips, and captures audio messages from PC microphones. Video and audio messages are encoded at a very high compressed rate in a real-time mode. From data input, data conversion, to sending video mails via Internet, or saving data to disks, the whole procedure is done in an easy and continuous process.

VLM 3's video clip compression rate is up to 1:900, and its playback rate is up to 30 frame per second. VLM 3 provides CIF (352 x 288 pixel) display resolution, and support true color configuration. A one-minute video mail with QCIF (176 x 144) resolution takes up less than 500KB of memory, making it easy to transmit and save mail. Users may always adjust resolution and recording parameters for different purpose.

VLM 3 supports all the hardware devices that are compliant with Video for Windows standard. Video for Windows is a well-accepted and well-tested standard. Thus, users do not have to worry about compatibility issues.

## 6. SOFTWARE REFERENCE

### 6.8.1 Starting VideoLive Mail

To start **VideoLive Mail**, click the Windows **Start** button, point to **Programs**, and then **CyberLink VideoLive Mail**, and then click **VideoLive Mail x.x**. VLM 3's Setup Wizard will start and guide you through configuring the video and audio input peripherals and to setup the e-mail environment.

1. Setup Wizard first will prompt a dialog to confirm that you want to configure the hardware and E-mail setting. Click **Yes** to continue the system parameter configuration.
2. The e-mail configuration screen appears. You will need to enter your name and the e-mail address. Click **Next** to continue.
3. The Internet e-mail configuration screen appears. You may choose to use the VLM 3 built-in E-mail functionality (SMTP mail), or use MAPI compliant e-mail system. Consult your ISP or MIS staff for the E-mail server IP address if you are not sure. Click **Next** to continue.
4. Then the Video Configuration screen shows up. You may have to specify the video driver for VLM 3, if there are several video-input devices installed. Then configure the number of video frames to be captured per second. Note that the more frames you choose, the bigger the file size will be. Click **Next** to continue.
5. Then the Setup Wizard will then search for the GSM CODECS module for audio compression, and prompt you with the result. Click **Next** to continue.
6. Setup Wizard then tests the audio volume during playing and recording. Click **Next** when ready.
7. Configuration done. Click **Finish** to complete the environmental setting procedure.

### 6.8.2 CyberLink VideoLive Mail User Interface



# 7. APPENDIX

## 7.1 Modem Riser

### 7.1.1 56K Software Modem

The Modem Riser (MR) is a high-speed PC communication peripheral which works with AMC'97/MC'97 compliant codecs. With this software modem, you can connect your computer to a remote location, receiving data at up to 56 Kbps in V.90 or K56flex modes.

### 7.1.2 Primary/Secondary MR

There are two types of modem risers: primary MR and secondary MR. In appearance, the primary MR has a crystal onboard but the secondary MR does not. If your motherboard has an audio codec and no PCI audio chipset onboard, you may use the secondary MR; otherwise, you should use the primary MR.

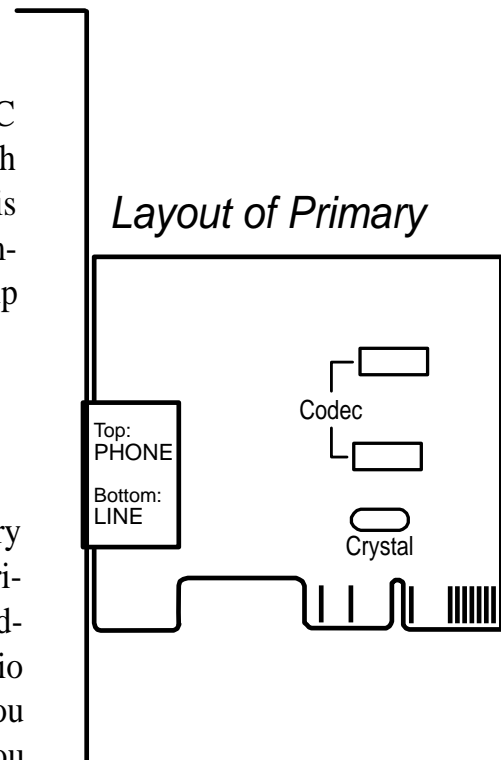

7. APPENDIX  
Modem Riser

### 7.1.3 Hardware Installation Procedure



1. Power OFF your computer.
2. Open the computer chassis and remove the metal plate on the AMR expansion slot.
3. Carefully align the MR card's connector to the AMR slot and press firmly.
4. Secure the MR card onto the chassis with the screw removed in step 2.
5. Connect the MR card's **LINE** connector to a telephone wall jack. Connect the **PHONE** connector to a telephone (optional).
6. Replace the computer chassis.

# 7. APPENDIX

## 7.1.4 Software Setup in Windows 98

The Modem Riser supports the Plug and Play feature. It allows your computer to automatically set the optimal configurations for the MR and communication software. Follow the procedure below to install the modem driver.

1. Power ON the computer after the hardware installation is completed.
2. Windows 98 will automatically detect the modem and display a “PCI Card” message under “Add New Hardware Found”.
3. Select **Search for the best driver for your device** and click **Next**.
4. Insert the Support CD that came with your motherboard into your CD-ROM drive. Enter the path **E:\Modem\Win98** (assuming that your CD-ROM drive is drive E:) for the MR driver.
5. After the driver is located, click **Next** and then click **Finish**.
6. Restart your computer. Double click the modem icon at the bottom-right corner of the window. 
7. Click the **Settings** tab. Select your country and language. Click **OK**.
8. Click **Start**, point to **Settings**, click **Control Panel**, double click **Modems**, click the **General** tab, and click **Motorola SM56 AC-L Modem**.
9. Click **Diagnostic** and then click the designated COM port as shown.
10. Click **More Info...**. If the computer system successfully communicates with the modem, responses will be displayed as shown.

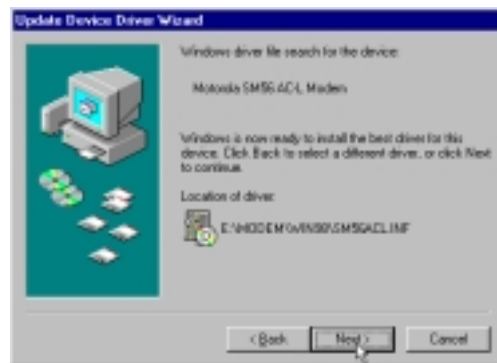
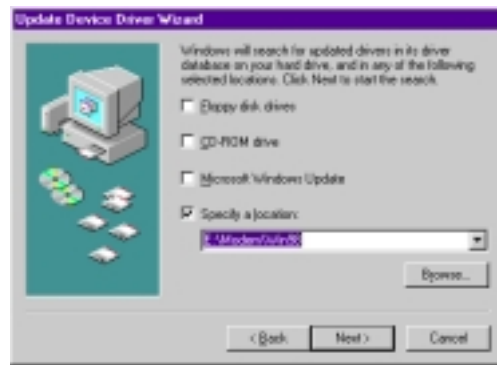

# 7. APPENDIX

## 7.2 Glossary

### 1394

1394 is the IEEE designation for the high performance serial bus at 12.5, 25 or 50MBytes/sec speeds. This serial bus defines both a back plane physical layer and a point-to-point cable-connected virtual bus. The primary application of the cable version is the integration of I/O connectivity at the back panel of personal computers using a low-cost, scalable, high-speed serial interface. The 1394 standard also provides new services such as live connect/disconnect capability for external devices including disk drives, printers and hand-held peripherals such as scanners and cameras. This is a new standard to complement the slower USB interface and to compete with the more expensive SCSI interface.

### AC'97 (Audio Codec '97)

AC '97 is the next step in enabling PCs with audio quality comparable to consumer electronics devices. The specification defines new cost-effective options to help integrate the components necessary to support next-generation auto-intensive PC applications such as DVD, 3-D multiplayer gaming and interactive music. The specification also defines new extensions supporting modem and docking to help both desktop and mobile manufacturers adopt these new technologies more quickly and cost-effectively. This specification uses software emulation to compete with the PCI SoundBlaster specification.

### ACPI (Advanced Configuration and Power Interface)

The ACPI specification defines a cross-platform interface designed to support many operating systems. ACPI defines a flexible and abstract hardware interface that provides a standard way to integrate power management features throughout a PC system, including hardware, operating system and application software. This enables the system to automatically turn ON and OFF peripherals such as CD-ROMs, network cards, hard disk drives, and printers, as well as consumer devices connected to the PC such as VCRs, TVs, phones, and stereos. With this technology, peripherals will also be able to activate the PC. For example, inserting a tape into a VCR can turn on the PC, which could then activate a large-screen TV and high-fidelity sound system.

### AGP (Accelerated Graphics Port)

An interface specification that enables high-performance 3D graphics on mainstream PCs. AGP was designed to offer the necessary bandwidth and latency to perform texture mapping directly from system memory.

Bus	Bus Frequency	Bandwidth	Data Transfer Rate
PCI	33MHz	33MHz	133MByte/sec
AGP 1X	66MHz	66MHz	266MByte/sec
AGP 2X	66MHz	133MHz	512MByte/sec
AGP 4X	66MHz	266MHz	1024MByte/sec

### BIOS (Basic Input/Output System)

BIOS is a set of routines that affect how the computer transfers data between computer components, such as memory, disks, and the display adapter. The BIOS instructions are built into the computer's read-only memory. BIOS parameters can be configured by the user through the BIOS Setup program. The BIOS can be updated using the provided utility to copy a new BIOS file into the EEPROM.

### Bit (Binary Digit)

Represents the smallest unit of data used by the computer. A bit can have one of two values: 0 or 1.



# 7. APPENDIX

---

## **Boot**

Boot means to start the computer operating system by loading it into system memory. When the manual instructs you to “boot” your system (or computer), it means to turn ON your computer. “Reboot” means to restart your computer. When using Windows 95 or later, selecting “Restart” from “Start | Shut Down...” will reboot your computer.

## **Bus Master IDE**

PIO (Programmable I/O) IDE requires that the CPU be involved in IDE access and waiting for mechanical events. Bus master IDE transfers data to/from the memory without interrupting the CPU. Bus master IDE driver and bus master IDE hard disk drives are required to support bus master IDE mode.

## **Byte (Binary Term)**

One byte is a group of eight contiguous bits. A byte is used to represent a single alphanumeric character, punctuation mark, or other symbol.

## **COM Port**

COM is a logical device name used by to designate the computer serial ports. Pointing devices, modems, and infrared modules can be connected to COM ports. Each COM port is configured to use a different IRQ and address assignment.

## **Concurrent PCI**

Concurrent PCI maximizes system performance with simultaneous CPU, PCI and ISA bus activities. It includes multi-transaction timing, enhanced write performance, a passive release mechanism and support for PCI 2.1 compliant delayed transactions. Concurrent PCI provides increased bandwidth, reduced system latencies, improves video and audio performance, and improves processing of host based applications.

## **CPU (Central Processing Unit)**

The CPU, sometimes called “Processor,” actually functions as the “brain” of the computer. It interprets and executes program commands and processes data stored in memory. Currently, there are socket 370 (for Pentium III FC-PGA and Celeron-PPGA), socket 7 (for Pentium, AMD, Cyrix, IBM), slot 1 (for Pentium II and III), slot 2 (for Xeon), and slot A (for AMD) processors.

## **Device Driver**

A device driver is a special set of instructions that allows the computer’s operating system to communicate with devices such as VGA, audio, printer, or modem.

## **DOS (Disk Operating System)**

DOS is the foundation on which all other programs and software applications operate, including Windows. DOS is responsible for allocating system resources such as memory, CPU time, disk space, and access to peripheral devices. For this reason, DOS constitutes the basic interface between you and your computer.

## **DRAM (Dynamic Random Access Memory)**

There are several different types of DRAM such as, EDO DRAM (Extended Data Output DRAM), SDRAM (Synchronous DRAM), and RDRAM (Rambus DRAM).

## **Flash ROM**

The flash ROM is designed to be a resident program and can be updated by a specific programming method. Normally, the flash ROM is used for system BIOS which initiates hardware devices and sets up necessary parameters for the OS. Since the contents of flash ROM can be modified, users are able to update the BIOS by themselves.

## **IDE (Integrated Drive Electronics)**

IDE devices integrate the drive control circuitry directly on the drive itself, eliminating the need for a separate adapter card (in the case for SCSI devices). UltraDMA/33 IDE devices can achieve up to 33MB/Sec transfer.



# 7. APPENDIX

---

## **LPT Port (Line Printer Port)**

Logical device name reserved by DOS for the computer parallel ports. Each LPT port is configured to use a different IRQ and address assignment.

## **MMX**

A set of 57 new instructions based on a technique called Single Instruction, Multiple Data (SIMD), which is built into the new Intel Pentium PP/MT (P55C) and Pentium II (Klamath) CPU as well as other x86-compatible microprocessors. The MMX instructions are designed to accelerate multimedia and communications applications, such as 3D video, 3D sound, video conference.

## **OnNow**

The OnNow design initiative is a comprehensive, system-wide approach to system and device power control. OnNow is a term for PC that is always ON but appears OFF and responds immediately to user or other requests. The OnNow design initiative involves changes that will occur in the Microsoft Windows operating system, device drivers, hardware, and applications, and also relies on the changes defined in the Advanced Configuration and Power Interface (ACPI) specification.

## **PC100**

SDRAM is Intel's goal is to ensure that memory subsystems continue to support evolving platform requirements and to assure that memory does not become a bottleneck to system performance. It is especially important to ensure that the PC memory roadmap evolves together with the performance roadmaps for the processors, I/O and graphics.

## **PCI Bus (Peripheral Component Interconnect Local Bus)**

PCI bus is a specification that defines a 32-bit data bus interface. PCI is a standard widely used by expansion card manufacturers.

## **PCI Bus Master**

The PCI Bus Master can perform data transfer without local CPU help and furthermore, the CPU can be treated as one of the Bus Masters. PCI 2.1 supports concurrent PCI operation to allow the local CPU and bus master to work simultaneously.

## **Plug and Play BIOS**

The ISA bus architecture requires the allocation of memory and I/O address, DMA channels and interrupt levels among multiple ISA cards. However, configuration of ISA cards is typically done with jumpers that change the decode maps for memory and I/O space and steer the DMA and interrupt signals to different pins on the bus. Further, system configuration files may need to be updated to reflect these changes. Users typically resolve sharing conflicts by referring to documentation provided by each manufacturer. For the average user, this configuration process can be unreliable and frustrating. Plug and play (PnP) BIOS eliminates the ISA add-on card hardware conflict problem. The PnP BIOS uses a memory block to define and remember each card's configuration, which allows the user to change the card's IRQs and DMA in BIOS either automatically or manually.

## **POST (Power On Self Test)**

When you turn ON the computer, it will first run through the POST, a series of software-controlled diagnostic tests. The POST checks system memory, the motherboard circuitry, the display, the keyboard, the diskette drive, and other I/O devices.

## **PS/2 Port**

PS/2 ports are based on IBM Micro Channel Architecture. This type of architecture transfers data through a 16-bit or 32-bit bus. A PS/2 mouse and/or keyboard may be used on ATX motherboards.

## **RDRAM (Rambus DRAM)**

Developed by Rambus, Inc., this type of memory can deliver up to 1.6GB of data per second. RDRAM is the first interface standard that can be directly implemented on high performance VLSI components such as, CMOS DRAMs, memory controllers, and graphics/video ICs.

# 7. APPENDIX

---

## **ROM (Read Only Memory)**

ROM is nonvolatile memory used to store permanent programs (called firmware) used in certain computer components. Flash ROM (or EEPROM) can be reprogrammed with new programs (or BIOS).

## **SCSI (Small Computer System Interface)**

High speed multi-threaded I/O interface defined by the X3T9.2 committee of the American National Standards Institute (ANSI) for connecting many peripheral devices. The standard started from 10MBytes/sec to 160MBytes/sec available today.

## **SDRAM (Synchronous DRAM)**

The SDRAM features a fully synchronous operation referenced to a positive edge clock whereby all operations are synchronized at a clock input which enables the coexistence of high performance and a simple user interface. SDRAM takes memory access away from the CPU's control; internal registers in the chips accept the request, and let the CPU do something else while the data requested is assembled for the next time the CPU talks to the memory. As they work on their own clock cycle, the rest of the system can be clocked faster. There is a version optimized for video cards, and main memory for motherboards.

## **SPD for SDRAM module**

Serial Presence Detect (SPD) is most like an ID detect for SDRAM module, it using a EEPROM component on DIMM module for storing module configuration information inside. The Serial Presence Detect function is implemented using a 2048 bit EEPROM component. This nonvolatile storage device contains data programmed by the DIMM manufacturer that identifies the module type and various SDRAM organization and timing parameters.

## **SSE (Streaming SIMD Extensions)**

A set of new instructions added to existing architectures that enables a better visual experience with an accelerated 3D geometry pipeline and support for new applications, such as real-time video encoding and speech recognition.

## **System Disk**

A system disk contains the core file of an operating system and is used to boot up the operating system.

## **UltraDMA**

Ultra DMA/33 is a "synchronous DMA" protocol designed by Intel. This function is included into Intel's PIIX4 chipset. The traditional IDE transfer only uses one edge of the data stroke as the data transfer. Ultra DMA/33 uses both edges of data strobe when the data is transferred. Hence, the data transfer rate is double of the PIO mode 4 or DMA mode 2 (16.6MB/s x2 = 33MB/s) on ATA-2 devices.

Ultra ATA/66, also known as Ultra DMA/66, is an extension of current Ultra ATA/33 interface. This new high-speed interface has doubled the Ultra ATA/33 burst data transfer rate to 66.6 Mbytes/sec and maximized disk performance under current PCI local bus environment

## **USB (Universal Serial Bus)**

A 4-pin serial cable bus that allows up to 127 plug and play computer peripherals such as keyboard, mouse, joystick, scanner, printer, modem, and monitor to share a bandwidth through a host scheduled token based protocol. This allows attaching or detaching while the host and other peripherals are in operation. Supports synchronous and asynchronous transfer types over the same set of wires up to 12Mbit/sec. USB 2.0 provides twice the transfer rate compared to USB 1.0 and competes with the 1394 standard.

## **Wake-On-LAN**

The computer automatically wakes up upon receiving a wake-up packet through a Network interface when it is under power soft-off, suspend or sleep mode.

# INDEX

---

## Symbols

3Deep Color Tuner  
Using 95

## A

Accelerated Graphics Port 8  
AGP Capability 63  
AGP Pro Slot 30  
Accessories  
Modem Riser 101  
AGP. *See* Accelerated Graphics Port  
ASUS PC Probe  
Using 87  
ATAPI CD-ROM 74  
Automatic Power Up 72

## B

BIOS  
Advanced Menu 58  
Beep Codes 44  
Boot Menu 74  
Boot Sequence 74  
Exit Menu 76  
Language 57  
Legend Bar 50  
Main Menu 52  
Menu Bar 50  
Power Menu 69  
Setup Defaults, loading 77  
Setup Program 49  
Smart BIOS 9  
Sub-menu launching 51  
Updating 45  
Boot Device  
Selection 74  
Boot Up NumLock Status 56  
Boot Virus Detection 75

## C

C-Media Audio Setup 92  
Central Processing Unit 27  
Central Processing Unit (CPU)

External Frequency 19  
Level 1/Level 2 Cache 59  
Speed 58  
Upgrade/Reinstallation 60

Chassis Intrusion 41  
Chip Configuration 62  
Connectors  
Audio 33  
Chassis Fan 36  
CPU Fan 36  
External 31  
Floppy Disk Drive 34  
Game/MIDI 33  
IDE 35  
Infrared Module 37  
Internal Audio 39  
Panel 43  
Parallel Port 32  
Power Supply Thermal Sensor 43  
PS/2 Keyboard 31  
PS/2 Mouse 31  
Serial Port 32  
SMBus 36, 38  
USB 32

CPU. *See* Central Processing Unit

CyberLink  
PowerDVD 98  
PowerPlayer SE 97  
VideoLive Mail 99  
CyberLink PowerDVD  
Using 98  
CyberLink PowerPlayer SE  
Using 97  
CyberLink VideoLive Mail  
Using 99

## D

DIMMs. *See* Dual Inline Memory  
Modules  
DIP Switches 18

# INDEX

---

## E

- Expansion Cards
  - Assigning IRQs 29
  - Installing 28
- Expansion Slots 9

## F

- Floppy 3 Mode 52
- Floppy Disk Drive Connector 34

## H

- Hard Disk Drives (HDDs)
  - CHS Capacity 55
  - Cylinders 54
  - Heads 55
  - LBA Capacity 55
  - Primary/Secondary Master 53
  - Primary/Secondary Slave 53
  - Sectors 54
  - Translation Method 54
  - Types 53
- Hardware Monitor 73
- Hardware Setup
  - CPU Installation 27
  - Memory Installation 26
  - Procedure 17
- Headers
  - USB 36

## I

- IDE Activity LED 34
- IDE Connectors 35
- IDE Hard Disks.
  - See* Hard Disk Drives (HDDs)
- Infrared Module Connector 37
- Installation
  - CPU 27

- Interrupt Request (IRQ)
  - Standard Assignments 29

## J

- JumperFree Mode
  - Notes for 60
- JumperFree™ Mode 18

## K

- Keyboard
  - Auto-Repeat Delay 56
  - Auto-Repeat Rate 56
  - Connector 31
  - Features 56
- Keyboard Lock Switch Lead 43

## L

- LAN
  - Jumper Setting 23
- Legacy Diskette 52
- LiveUpdate
  - Using 94

## M

- Memory Hole 64
- Memory Installation 26
- Modem Riser 101
- Motherboard
  - Components 12, 13
  - IRQ Table 29
  - Layout 14
  - Settings 17
  - Specifications 8
- Mouse
  - Connector 31
- Multi-Channel Audio
  - Using 92
- Multi-Sector Transfers 55

# INDEX

---

## P

- Parallel Port 65
  - Modes 66
- Parallel Port Connector 32
- Password
  - If You Forget 57
  - Notes 57
  - Supervisor 57
  - User 57
- PC Probe
  - Using 87
- PCI Configuration 67
- PCI Latency Timer 67
- PCI/VGA Palette Snoop 67
- PIO Mode 55
- Plug & Play O/S 75
- Ports. *See* Connectors
- Power Management 69
- Power On Self Test 75
- PowerDVD 98
  - Using 98
- PowerPlayer SE
  - Using 97
- Procedure
  - CPU Installation 27
- Procedures
  - Modem Riser Installation 101
- PS/2 Keyboard 31
- PS/2 Mouse 31
  - Function Control 59

## R

- RTC RAM
  - Clearing 24

## S

- SCSI BIOS 67
- SDRAM
  - Active to Precharge Time 63
  - CAS Latency 62

- Configuration 62
- RAS Precharge Time 62
- RAS to CAS Delay 63
- Read Around Write 63
- Serial Ports 65
  - Connectors 32
- Smart Manager 83
  - Modes 86
  - Using 85
- SMART Monitoring 55
- SMBus Connector 38
- Suspend Mode 70
- System Chipset 8
- System Date 52
- System Frequency Multiple 58
- System Hangup 61
- System Start Up 44
- System Time 52
- System/PCI Frequency 58

## T

- Thermal Sensor Connector 40

## U

- UART2 65
- Ultra DMA Mode 55
- Universal Serial Bus (USB) 32
  - Headers 36
  - Ports 32
- USB Legacy Support 59
- Using
  - 3Deep Color Tuner 95
  - LiveUpdate 94, 95
  - Multi-Channel Audio Feature 92
  - PC Probe 87
  - PowerPlayer SE 97
  - Windbond Smart Manager 83
- USWC 64

# INDEX

---

## V

Video Memory 64

VideoLive Mail 99  
Using 99

## W

Winbond Smart Manager 83

Windbond Smart Manager  
Modes 86  
Using 85