

Subminiature Toggle Switch

A9T

Double-sided clip contact mechanism combined with see-saw action.

- Gold-plated clip contact and cleaning mechanisms ensure high reliability.
- Specially designed to prevent grease entry into the contact portion.
- Sealed against flux entry.
- Washable, equivalent to IP64 (IEC-60529).

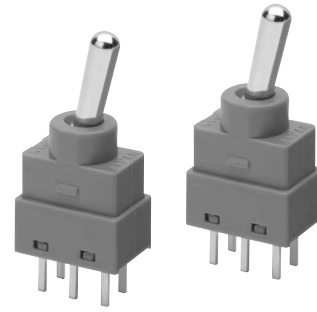





RoHS Compliant

Typical Applications





Security Control Boards
Electric Power Instrumentation
Program Controllers

■ List of Models





● DIP Terminal Models

Actuator Shapes			Standard		Quantity per bag
Switching Functions					
					
ON	—	ON	A9T11-0011	A9T21-0011	100
ON	OFF	ON	A9T12-0011	A9T22-0011	
(ON)	—	ON	A9T13-0011	A9T23-0011	
(ON)	OFF	(ON)	A9T14-0011	A9T24-0011	
(ON)	OFF	ON	A9T15-0011	A9T25-0011	

● Right Angle Terminal Models

Actuator Shapes			Standard		Quantity per bag
Switching Functions					
					
ON	—	ON	A9T11-0012	A9T21-0012	100
ON	OFF	ON	A9T12-0012	A9T22-0012	
(ON)	—	ON	A9T13-0012	A9T23-0012	
(ON)	OFF	(ON)	A9T14-0012	A9T24-0012	
(ON)	OFF	ON	A9T15-0012	A9T25-0012	

● Vertical Mount Terminal Models

Actuator Shapes			Standard		Quantity per bag
Switching Functions					
			SPDT	DPDT	
ON	—	ON	A9T11-0013	A9T21-0013	100
ON	OFF	ON	A9T12-0013	A9T22-0013	
(ON)	—	ON	A9T13-0013	A9T23-0013	
(ON)	OFF	(ON)	A9T14-0013	A9T24-0013	
(ON)	OFF	ON	A9T15-0013	A9T25-0013	

- Note:** 1. (ON) shows Momentary.
 2. Switching Functions show the view from the side of Type and Brand name marking.
 3. Actuator does not stop at "-" position.

■ Ratings/Characteristics

Ratings	50 mA at 60 VAC/DC, 1 μA (minimum current) at 20 mVAC/DC	
Ambient operating temperature	-20 to +80 °C 60% RH max. (with no icing or condensation)	
Ambient operating humidity	45 to 85%RH (at +5 to +35 °C)	
Insulation resistance	1,000 MΩ min. (Initial value)	
Contact resistance	50 mΩ max. (Initial value)	
Dielectric strength	500 VAC for 1 min between terminals, between terminals and ground	
Vibration resistance	Malfunction	10 to 55 Hz, 1.5-mm double amplitude
Shock resistance	Malfunction	500 m/s ² min.
Durability	Mechanical	50,000 operations min.
	Electrical	50,000 operations min.
Operating force	0.49 to 3.43 N {50 to 350 gf}	
Weight	DIP Terminal	Standard: 0.8 g
	Right Angle Terminal	Standard: 1 g
	Vertical Mount Terminal	Standard: 1 g

■ Dimensions (Unit: mm)

● DIP Terminal Models

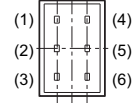
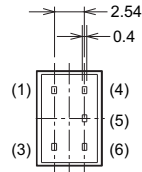
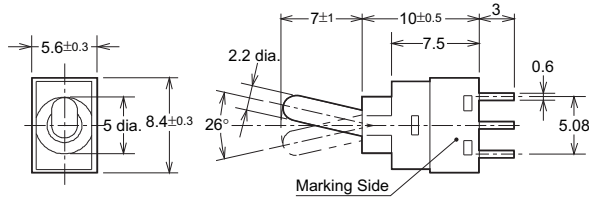
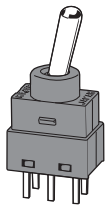

Single Pole Type Double Pole Type
PCB Dimensions (Top View)

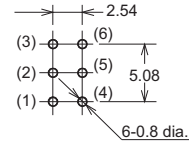
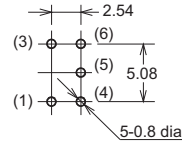

Single Pole Type Double Pole Type

Note: No. (1) and (3) terminals in the SPDT models are dummies to support the Switch case.

● Right Angle Terminal Models

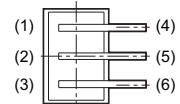
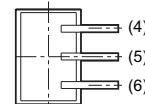
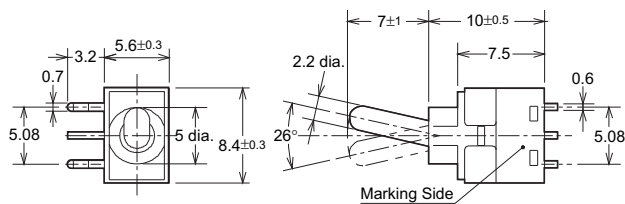
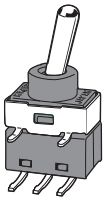

Single Pole Type Double Pole Type

PCB Dimensions (Top View)

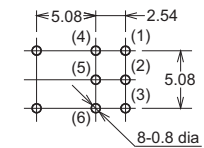
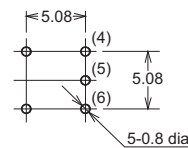

Single Pole Type Double Pole Type

● Vertical Mount Terminal Models

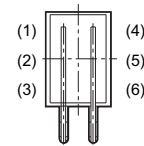
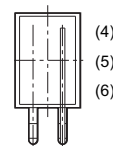
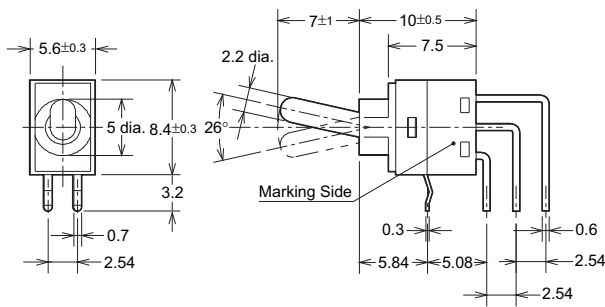
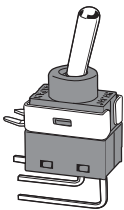

Single Pole Type Double Pole Type



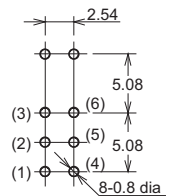
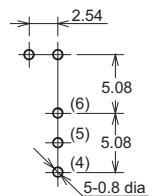









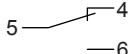

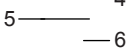
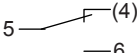

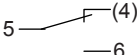
PCB Dimensions (Top View)

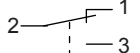

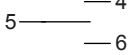
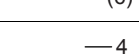
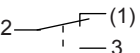
Single Pole Type Double Pole Type

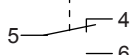
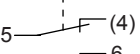
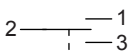
Note: Unless otherwise specified, a tolerance of ±0.4 mm applies to all dimensions.

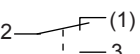
■ Switching Function / Internal Connections

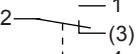
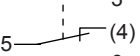
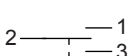
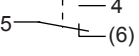
	Switching Functions			Contact Forms		
						
SPDT Models	ON	—	ON		—	
	ON	OFF	ON			
	(ON)	—	ON		—	
	(ON)	OFF	(ON)			
	(ON)	OFF	ON			
DPDT Models	ON	—	ON		—	
	ON	OFF	ON			
	(ON)	—	ON		—	
	(ON)	OFF	(ON)			
	(ON)	OFF	ON			

Note: (ON) shows Momentary.

■ Safety Precautions

Be sure to read the Safety precautions common to all PCB-mount Manual Switches for correct use.

- Application examples provided in this document are for reference only. In actual applications, confirm equipment functions and safety before using the product.
- Consult your OMRON representative before using the product under conditions which are not described in the manual or applying the product to nuclear control systems, railroad systems, aviation systems, vehicles, combustion systems, medical equipment, amusement machines, safety equipment, and other systems or equipment that may have a serious influence on lives and property if used improperly. Make sure that the ratings and performance characteristics of the product provide a margin of safety for the system or equipment, and be sure to provide the system or equipment with double safety mechanisms.

Note: Do not use this document to operate the Unit.