

PMIC Solution for 12V Adapter Systems
with 2-Output High Performance Step-Down Converters

General Description

The AAT2689 provides two independently regulated DC outputs, consisting of a high voltage step-down (Buck) regulator and a low input voltage low dropout (LDO) regulator. The PMIC is optimized for low cost 12V adapter inputs, making the device the ideal system-on-a-chip power solution for consumer communications equipment.

Channel 1 is a step-down (Buck) regulator with an input voltage range of 6V to 24V providing up to 2500mA output current. 490kHz fixed switching frequency allows small L/C filtering components. Channel 1 utilizes voltage mode control configured for optimum performance across the entire output voltage and load range.

Channel 2 is a low-dropout (LDO) regulator providing up to 600mA output current. The device provides extremely low output noise, low quiescent current and excellent transient response.

The controller includes integrated cycle-by-cycle over-current protection, soft-start and over-temperature disable features. Independent input and enable pins provide maximum design flexibility.

The AAT2689 is available in the Pb-free 3x4mm 16-pin TDFN package. The rated operating temperature range is -40°C to 85°C.

Features

- 2-Output Step-Down Converters:
 - Channel 1 (Buck): $V_{IN1} = 6V$ to $24V$
 - V_{OUT1} adjustable from $1.5V$ to $5.5V$
 - I_{OUT1} up to $2.5A$
 - High Switching Frequency
 - Voltage Mode Control
 - PWM Fixed Frequency for Low-Ripple
 - Channel 2 (LDO): $V_{IN2} = 2.7V$ to $5.5V$
 - I_{OUT2} up to $600mA$
 - $1V$ Dropout Voltage at $600mA$
 - High Accuracy $\pm 1.5\%$
- Small Solution Size
 - System on a Chip
 - Ultra-small External L/C
- Shutdown Current $< 35\mu A$
- Independent Enable Pins
- Adjustable Over-Current Protection
- Over-Temperature Protection
- Internal Soft Start
- 3x4mm 16-Pin TDFN Low Profile Thermally Enhanced Package
- -40°C to 85°C Temperature Range

Applications

- DSL and Cable Modems
- Notebook Computers
- Satellite Settop Box
- Wireless LAN Systems

Typical Application

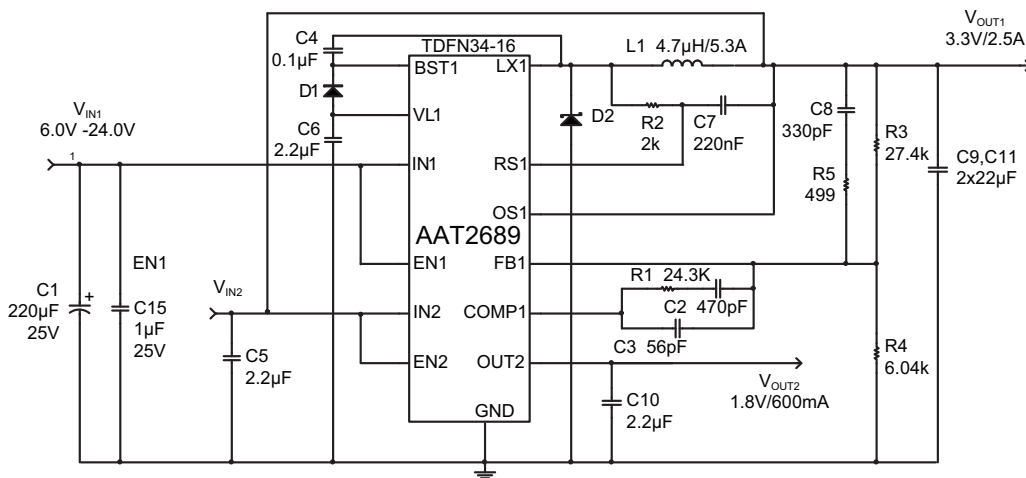

**PMIC Solution for 12V Adapter Systems
with 2-Output High Performance Step-Down Converters**

Pin Descriptions

Pin #	Symbol	Function
1	IN1	Input supply voltage pin for Channel 1 step-down (Buck) regulator. Connect both IN1 pins together. Connect the input capacitor close to this pin for best noise performance.
2	BST1	Channel 1 step-down (Buck) regulator boost drive input pin. Connect the cathode of fast rectifier from this pin and connect a 100nF capacitor from this pin to the Channel 1 switching node (LX) for internal hi-side MOSFET gate drive.
3	EN1	Channel 1 step-down (Buck) regulator enable input pin. Active high enables internal linear regulator and Channel 1 output.
4	RS1	Channel 1 output current sense pin. Connect a small signal resistor from this pin to the Channel 1 switching node (LX) to enable over-current sense for step-down (Buck) converter.
5	OS1	Channel 1 output sense voltage pin. Connect to the output capacitor to enable over-current sense for step-down (Buck) converter.
6	COMP1	Compensation pin for Channel 1 step-down (Buck) regulator. Connect a series resistor and capacitor network to compensate for the voltage mode control loop.
7	FB1	Feedback input pin for Channel 1 step-down (Buck) converter. Connect an external resistor divider to this pin to program the output voltage to the desired value.
8	EN2	Channel 2 linear low dropout (LDO) enable input pin. Active high.
9	IN2	Input supply voltage pin for Channel 2 linear low dropout (LDO) regulator. Connect a 2.2μF ceramic input capacitor close to this pin.
10	OUT2	Output of Channel 2 of linear low dropout (LDO) regulator. Connect a 2.2μF ceramic capacitor from this pin to the GND pin.
11	AGND	Analog ground pin for LDO and Buck (step-down) controller. Tie to PCB ground plane.
12	VL1	Internal linear regulator for Channel 1 step-down (Buck) converter. Connect a 2.2μF/6.3V capacitor from this pin to the GND pin.
13	GND	Ground pin for both channels. Power return pin for both channels. Connect returns of both channels input and output capacitors close to this pin for best noise performance.
14	IN1	Input supply voltage pin for Channel 1 step-down (Buck) regulator. Connect both IN1 pins together. Connect the input capacitor close to this pin for best noise performance.
15	LX1	Channel 1 step-down (Buck) converter switching pin. Connect output inductor to this pin. Connect both LX1 pins together.
16	LX1	Channel 1 step-down (Buck) converter switching pin. Connect output inductor to this pin. Connect both LX1 pins together.
EP1	GND	Exposed paddle 1 tied to ground. Connect to PCB heatsink for optimum thermal performance of internal LDO device.
EP2	IN1	Exposed paddle 2 tied to drain of internal high side MOSFET. Connect to PCB heatsink for optimum thermal performance of step-down (Buck) regulator.

Pin Configuration

**TDFN34-16 Dual Paddle
(Top View)**

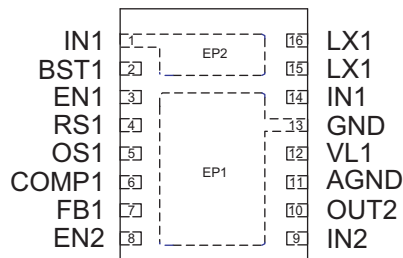

**PMIC Solution for 12V Adapter Systems
with 2-Output High Performance Step-Down Converters**

Absolute Maximum Ratings¹

Symbol	Description	Value	Units
$V_{IN(HI)}, V_{EN1}$	IN1, LX, EN1 to GND	-0.3 to 30.0	V
$V_{IN(LO)}$	IN2, VL1 to GND	-0.3 to 6.0	V
$V_{BST1-LX1}$	BST1 to LX1	-0.3 to 6.0	V
$V_{CONTROL}$	FB1, COMP1, RS1, OS1, OUT2 to GND	-0.3 to $V_{IN(LO)} + 0.3$	V
V_{EN2}	EN2 to GND	-0.3 to $V_{IN2} + 0.3$	V
$I_{IN(PULSED)}$	IN to LX	12.0	A
T_J	Operating Junction Temperature Range	-40 to 150	°C
T_{LEAD}	Maximum Soldering Temperature (at leads, 10 sec)	300	°C

Thermal Information

Symbol	Description	Value	Units
Θ_{JA}	Thermal Resistance ²	50	°C/W
P_D	Maximum Power Dissipation ³	2.0	W

1. Stresses above those listed in Absolute Maximum Ratings may cause permanent damage to the device. Functional operation at conditions other than the operating conditions specified is not implied. Only one Absolute Maximum Rating should be applied at any one time.
2. Mounted on an FR4 board with exposed paddle connected to ground plane.
3. Derate 20mW/°C above 25°C ambient temperature.

**PMIC Solution for 12V Adapter Systems
with 2-Output High Performance Step-Down Converters**

Electrical Characteristics¹

$V_{IN1} = 12.0V$, $V_{IN2} = 3.3V$; $T_A = -40^{\circ}C$ to $85^{\circ}C$, unless noted otherwise. Typical values are at $T_A = 25^{\circ}C$.

Symbol	Description	Conditions	Min	Typ	Max	Units
Channel 1: Step-Down (Buck) Converter						
V_{IN1}	Input Voltage		6.0		24.0	V
V_{UVLO1}	UVLO Threshold	V_{IN1} Rising			5.0	V
		V_{IN1} Hysteresis		300		mV
		V_{IN1} Falling	3.0			V
V_{OUT1}	Output Voltage Range		1.5		5.5	V
V_{FB1}	Feedback Pin Voltage		0.591	0.600	0.609	V
V_{OUT1}	Output Voltage Accuracy	$I_{OUT1} = 0$ to 2.5A	-3.0		+3.0	%
$(\Delta V_{OUT1}/V_{OUT1}) / \Delta V_{IN1}$	Line Regulation	$V_{IN1} = 6V$ to 24V, $V_{OUT1} = 3.3V$, $I_{OUT1} = 0V$ to 2.5A		0.014		%/V
$(\Delta V_{OUT1}/V_{OUT1}) / \Delta I_{OUT1}$	Load Regulation	$V_{IN1} = 6V$ to 24V, $V_{OUT1} = 3.3V$, $I_{OUT1} = 0A$ to 2.5A		0.1		%/A
I_{Q1}	Quiescent Current	$V_{EN1} = \text{High}$, No load		0.6		mA
I_{SHDN1}	Shutdown Current	$V_{EN1} = \text{Low}$, $V_{L1} = 0V$			35.0	μA
V_{OCP1}	Over-Current Offset Voltage	$V_{EN1} = \text{High}$, $V_{IN1} = 6V$ to 24V, $T_A = 25^{\circ}C$	80	100	120	mV
I_{LX1}	LX Pin Leakage Current	$V_{IN1} = 24.0V$, $V_{EN1} = \text{Low}$	-1.0		1.0	μA
D_{MAX}	Maximum Duty Cycle			85		%
$T_{ON(MIN)}$	Minimum On-Time	$V_{IN1} = 6V$ to 24V		100		ns
$R_{DSON(H)}$	Hi Side On-Resistance	$V_{L1} = 4.5V$		70		$m\Omega$
F_{OSC1}	Oscillator Frequency		350	490	650	kHz
$F_{FOLDBACK1}$	Short Circuit Foldback Frequency	Current Limit Triggered		100		kHz
T_{S1}	Start-Up Time	From Enable Channel 1 to Output Regulation		2.5		ms
Channel 2: 600mA Linear Low Dropout (LDO) Regulator						
V_{IN2}	Input Voltage		2.7		5.5	V
V_{DO2}	Dropout Voltage	$98\% \times V_{OUT2(NOM)}$, $I_{OUT2} = 600mA$		1000	1300	mV
I_{Q2}	Quiescent (Ground) Current	No load		70	125	μA
I_{SHDN2}	Shutdown Current	$V_{EN2} = \text{GND}$			1.0	μA
$V_{OUT2(TOL)}$	Output Voltage Tolerance	$I_{OUT2} = 1$ to 600mA, $V_{IN2} = 2.7V$ to 5.5V, $T_A = 25^{\circ}C$	-2.0		+2.0	%
		$I_{OUT2} = 1$ to 600mA, $V_{IN2} = 2.7V$ to 5.5V, $T_A = -40^{\circ}C$ to $85^{\circ}C$	-3.5		+3.5	%
e_N	Output Noise	BW = 300Hz to 50kHz		250		μV_{RMS}
PSRR	Power Supply Rejection Ratio	$I_{OUT2} = 10mA$	1kHz	67		dB
			10kHz	47		
			1MHz	45		
I_{LIMIT2}	Current Limit		700	800		mA
T_{S2}	Enable Start-Up Delay	From Enable Channel 2 to Output Regulation		15		μs
Over-Temperature, EN Logic						
$T_{SD1,2}$	Over-Temperature Shutdown Threshold			135		$^{\circ}C$
	Over-Temperature Shutdown Hysteresis			15		$^{\circ}C$
$V_{EN1,EN2(L)}$	Enable Threshold Low				0.6	V
$V_{EN1(H)}$	Enable Threshold High		2.5			V
$V_{EN2(H)}$	Enable Threshold High		1.4			V
$I_{EN1,EN2}$	Input Low Current		-1.0		1.0	μA

1. The AAT2689 is guaranteed to meet performance specifications over the $-40^{\circ}C$ to $+85^{\circ}C$ operating temperature range and is assured by design, characterization and correlation with statistical process controls.

AAT2689

PMIC Solution for 12V Adapter Systems with 2-Output High Performance Step-Down Converters

Typical Characteristics

Step-Down Converter Efficiency vs. Load
($V_{OUT1} = 3.3V$; $L = 4.7\mu H$)

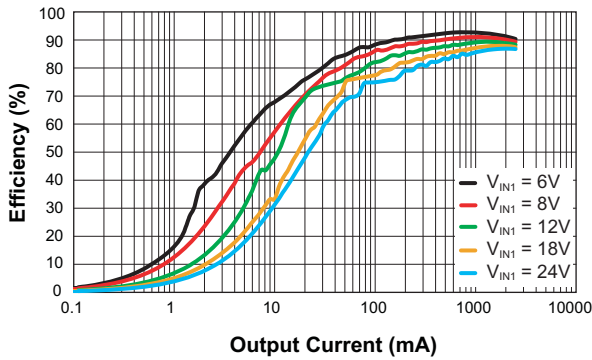

Step-Down Converter DC Regulation
($V_{OUT1} = 3.3V$; $L = 4.7\mu H$)

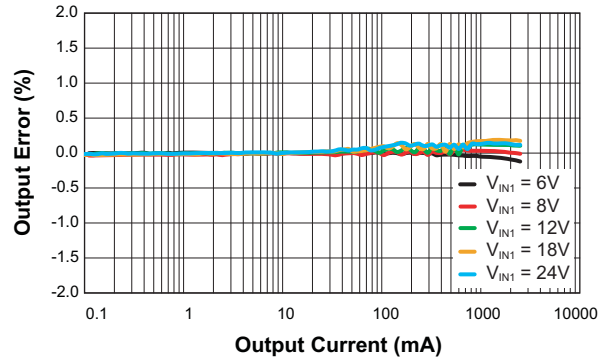

Step-Down Converter Line Regulation
($V_{OUT1} = 3.3V$; $L = 4.7\mu H$)

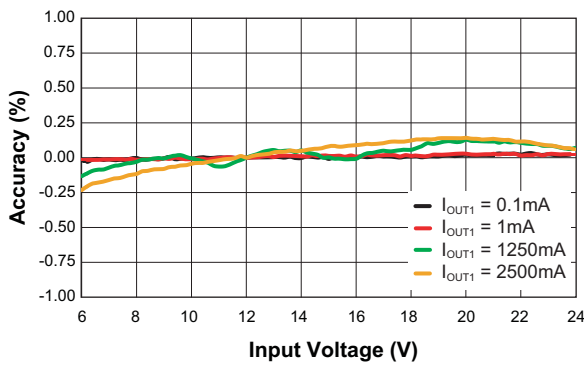

Step-Down Converter Output Ripple
($V_{IN1} = 12V$; $V_{OUT1} = 3.3V$; $I_{OUT1} = 1mA$)

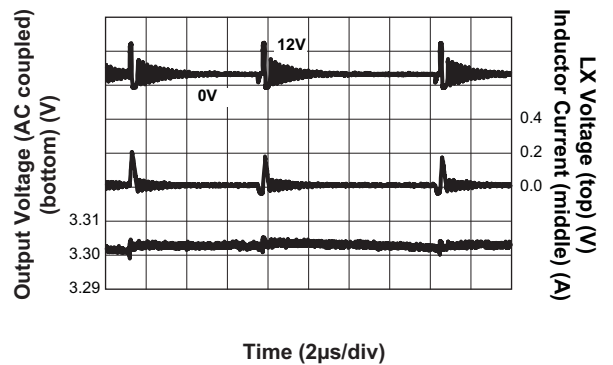

Step-Down Converter Output Ripple
($V_{IN1} = 12V$; $V_{OUT1} = 3.3V$; $I_{OUT1} = 2.5A$)

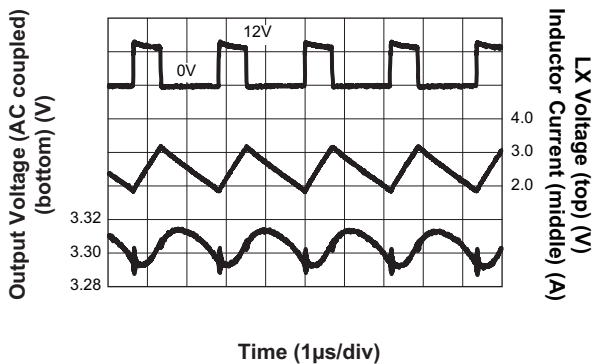

Step-Down Converter Load Transient Response

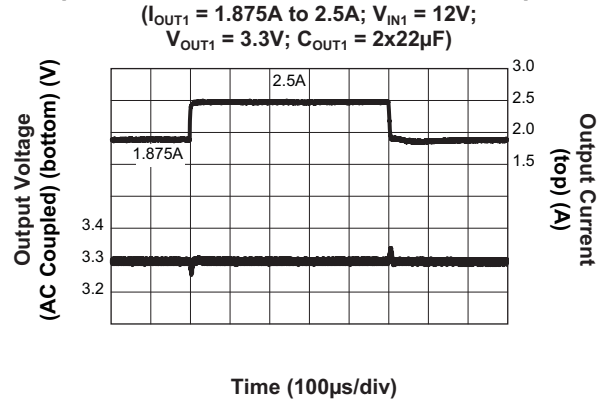

AAT2689

PMIC Solution for 12V Adapter Systems with 2-Output High Performance Step-Down Converters

Typical Characteristics

Step-Down Converter Load Transient Response

($I_{OUT1} = 1.25A$ to $2.5A$; $V_{IN1} = 12V$;
 $V_{OUT1} = 3.3V$; $C_{OUT1} = 2x22\mu F$)

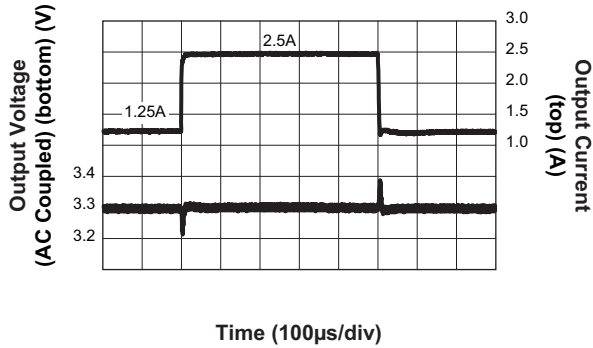

Step-Down Converter Line Transient Response

($V_{IN1} = 6V$ to $10V$; $V_{OUT1} = 3.3V$; $I_{OUT1} = 2.5A$)

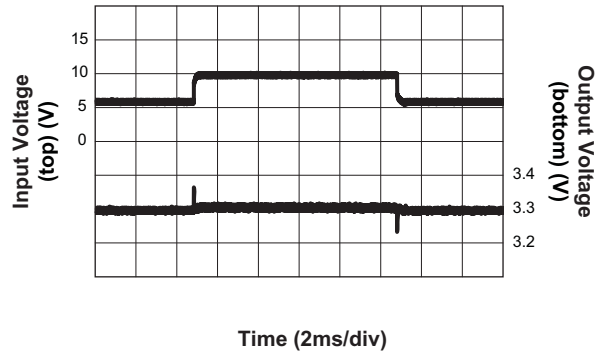

Step-Down Converter Soft Start

($V_{IN1} = 12V$; $V_{EN1} = 10V$; $V_{OUT1} = 3.3V$; $I_{OUT1} = 2.5A$)

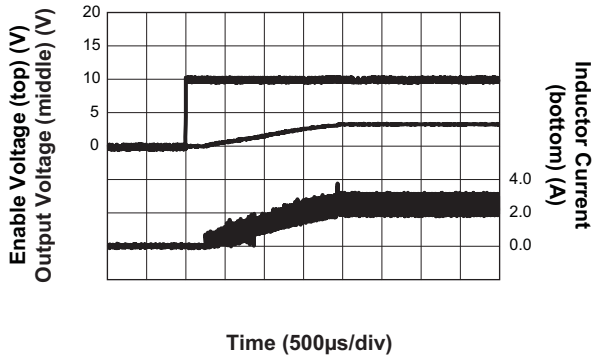

Step-Down Converter Output Voltage Error vs. Temperature

($V_{IN1} = 12V$; $V_{OUT1} = 3.3V$)

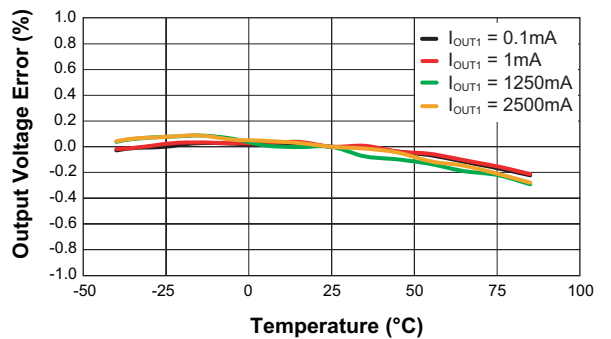

Step-Down Converter Switching Frequency vs. Temperature

($V_{IN1} = 12V$; $I_{OUT1} = 2.5A$)

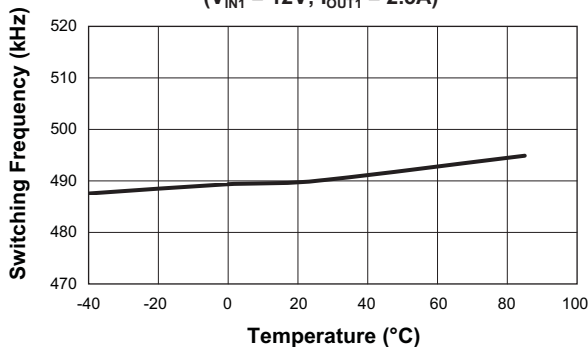

Step-Down Converter Switching Frequency vs. Input Voltage

($V_{OUT1} = 3.3V$; $I_{OUT1} = 2.5A$)

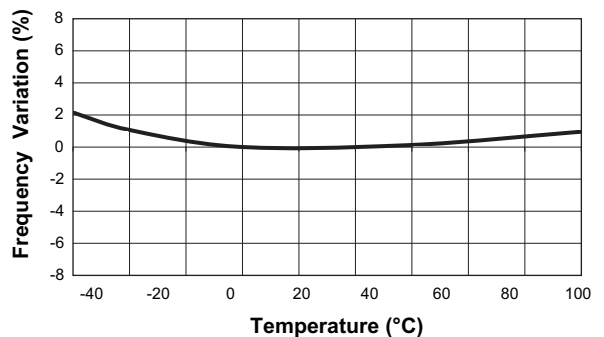

PMIC Solution for 12V Adapter Systems with 2-Output High Performance Step-Down Converters

Typical Characteristics

Step-Down Converter Input Current vs. Input Voltage
($V_{EN1} = V_{IN1}$)

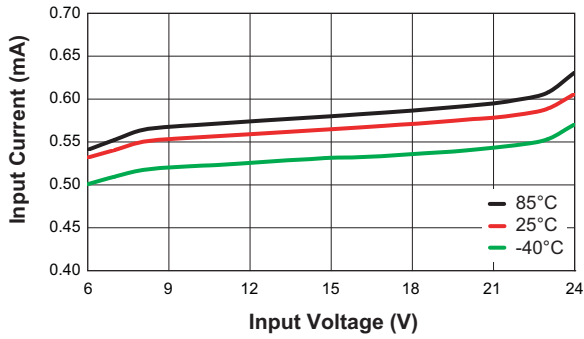

LDO Dropout Voltage vs. Temperature

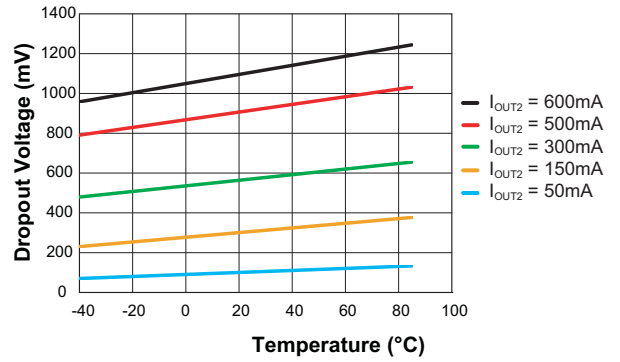

LDO Dropout Characteristics
($V_{OUT2} = 1.8V$)

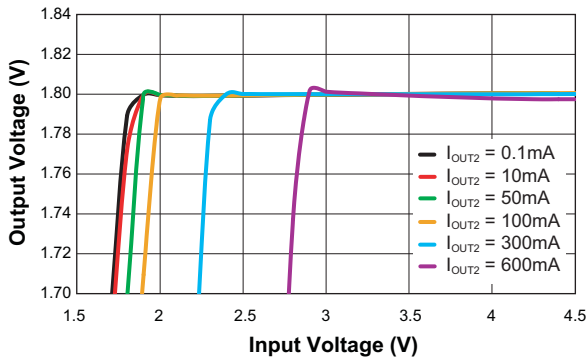

LDO Dropout Voltage vs. Output Current

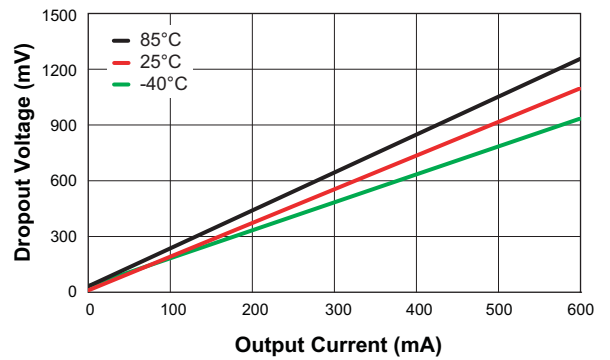

LDO Input Current vs. Input Voltage
($V_{EN1} = 0V$; $V_{EN2} = V_{IN2}$)

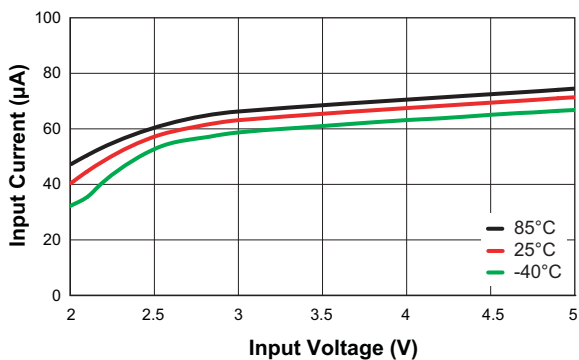

LDO V_{IH} and V_{IL} vs. Input Voltage

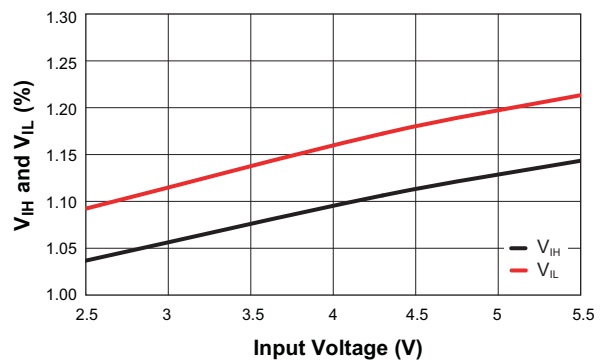

AAT2689

PMIC Solution for 12V Adapter Systems with 2-Output High Performance Step-Down Converters

Typical Characteristics

LDO Turn-Off Response Time

($V_{IN2} = 3.3V$; $V_{EN2} = 3.3V$; $V_{OUT2} = 1.8V$; $I_{OUT2} = 600mA$)

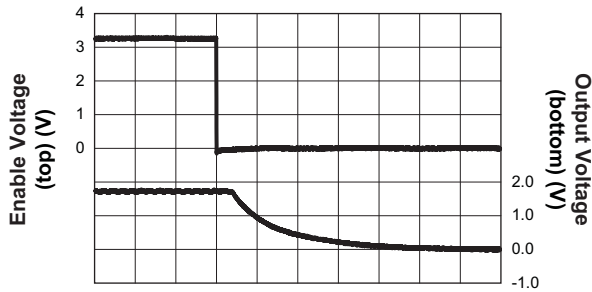

Time (5µs/div)

LDO Turn-On Time from Enable

($V_{IN2} = 3.3V$; $V_{EN2} = 3.3V$; $V_{OUT2} = 1.8V$; $I_{OUT2} = 600mA$)

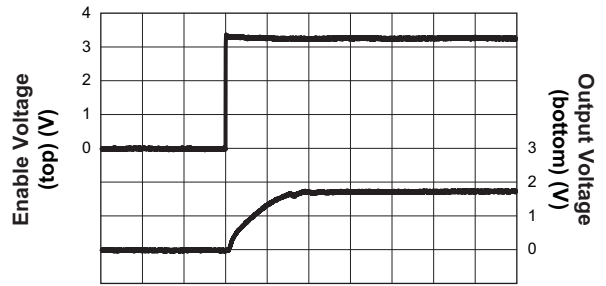

Time (5µs/div)

LDO Output Voltage Error vs. Temperature

($V_{IN2} = 3.3V$; $V_{OUT2} = 1.8V$)

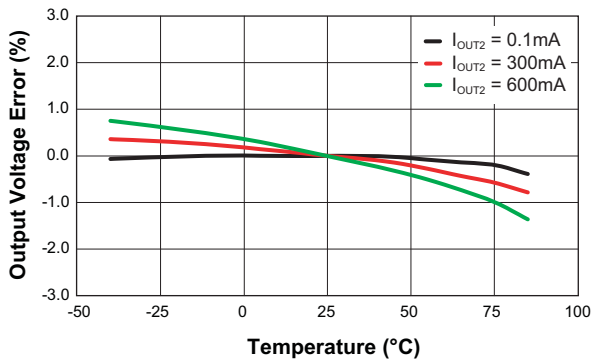

LDO Load Transient Response

($I_{OUT2} = 0.3A$ to $0.6A$; $V_{IN2} = 3.3V$; $V_{OUT2} = 1.8V$; $C_{OUT2} = 2.2µF$)

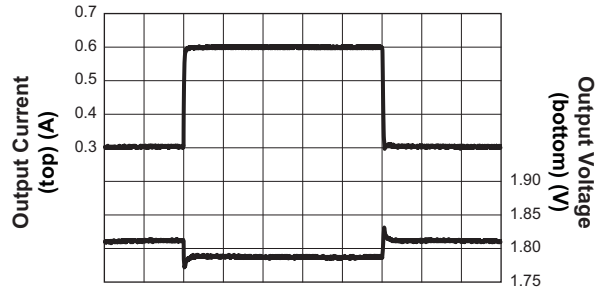

Time (40µs/div)

LDO Load Transient Response

($I_{OUT2} = 0.06A$ to $0.6A$; $V_{IN2} = 3.3V$; $V_{OUT2} = 1.8V$; $C_{OUT2} = 2.2µF$)

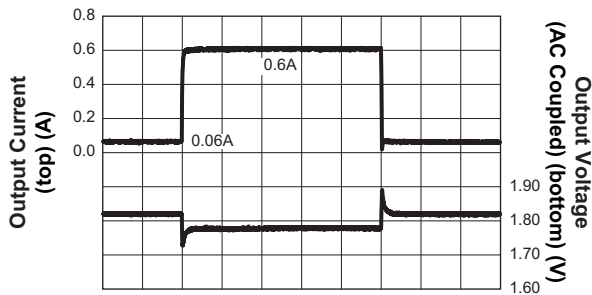

Time (40µs/div)

LDO Line Transient Response

($V_{IN2} = 3V$ to $4V$; $V_{OUT2} = 1.8V$; $I_{OUT2} = 600mA$; $C_{OUT2} = 2.2µF$)

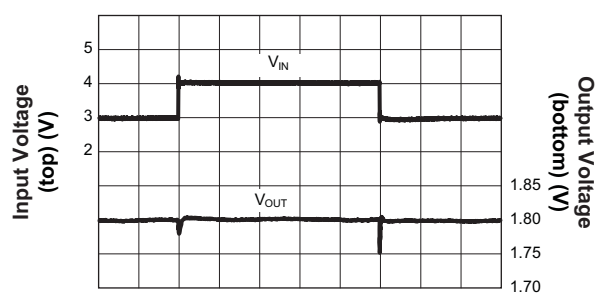

Time (200µs/div)

AAT2689

*PMIC Solution for 12V Adapter Systems
with 2-Output High Performance Step-Down Converters*

Typical Characteristics

LDO Output Voltage Noise
($I_{OUT2} = 10\text{mA}$; Power BW: 300~50KHz)

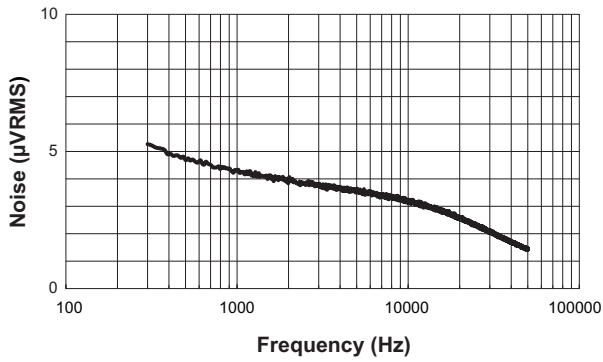

LDO Power Supply Rejection Ratio, PSRR
($I_{OUT2} = 10\text{mA}$; BW: 100KHz to 300KHz)

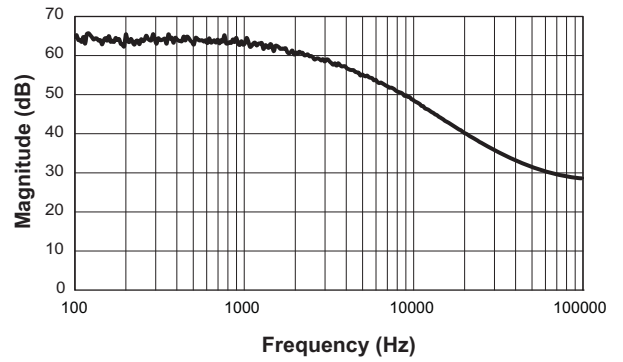

**PMIC Solution for 12V Adapter Systems
with 2-Output High Performance Step-Down Converters**

Functional Block Diagram

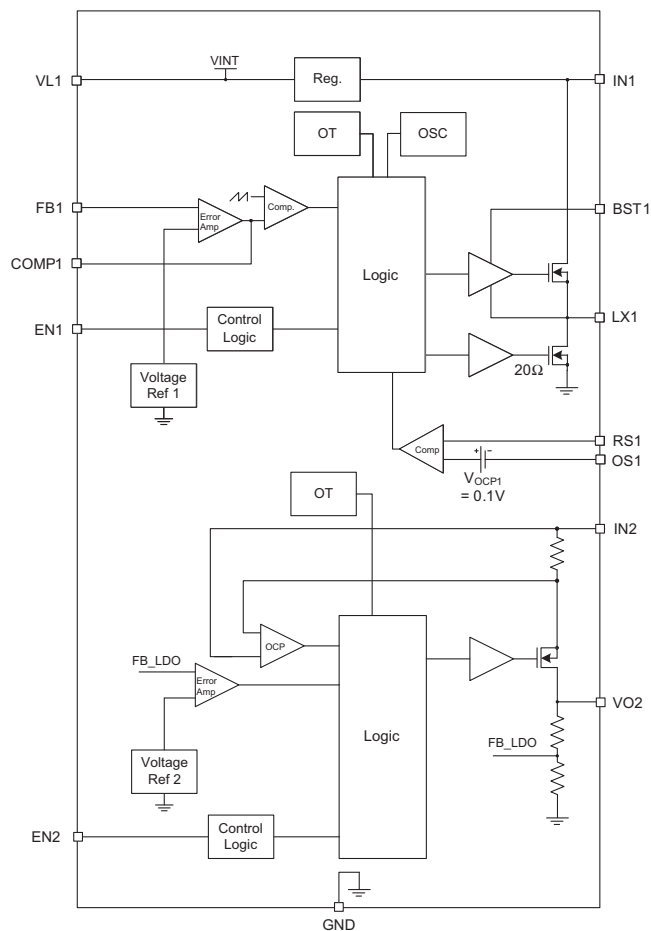

Functional Description

The AAT2689 provides two independently regulated DC outputs; consisting of a high voltage step-down (Buck) regulator and a low input voltage linear low dropout (LDO) regulator. The PMIC is optimized for low cost 12V adapter inputs, making the device an ideal system-on-a-chip power solution for consumer communications equipment.

Channel 1 is a step-down (Buck) regulator with an input voltage range 6.0 to 24V; providing up to 2500mA output current. 490kHz fixed switching frequency allows small L/C filtering components.

Channel 1 utilizes voltage mode control configured for optimum performance across the entire output voltage and load range. The controller includes integrated over-current, soft-start and over-temperature protection. Over-

current is sensed through the output inductor DC winding resistance (DCR). An external resistor network adjusts the current limit according to the DCR of the desired inductor and the desired output current limit. Frequency reduction limits over-current stresses during short-circuit events. The operating frequency returns to the nominal setting when over-current conditions are removed.

Channel 2 is a linear low-dropout (LDO) regulator providing up to 600mA output current at a factory set output voltage. The device provides extremely low output noise, low quiescent current and excellent transient response.

The controllers include integrated over-current, soft-start and over-temperature protection. Independent input and enable pins provide maximum design flexibility. The AAT2689 is available in the Pb-free 3x4mm 16-pin TDFN package. The rated operating temperature range is -40°C to 85°C.

PMIC Solution for 12V Adapter Systems with 2-Output High Performance Step-Down Converters

Applications Information

Output 1 is a high voltage DC/DC Buck (step-down) converter providing an output voltage from 1.5V to 5.5V. The integrated high-side N-channel MOSFET device provides up to 2.5A output current. Input voltage range is 6.0V to 24.0V. The step-down converter utilizes constant frequency (PWM-mode) voltage mode control to achieve high operating efficiency while maintaining extremely low output noise across the operating range. High 490kHz (nominal) switching frequency allows small external filtering components, achieving minimum cost and solution size. External compensation allows the designer to optimize the transient response while achieving stability across the operating range.

Output 2 is a low voltage, low dropout (LDO) linear regulator providing 1.8V with up to 600mA output current. The input voltage range is 2.7V to 5.5V. The LDO provides very low noise output which can be derived directly from the Output 1 channel.

Output Voltage and Current

Output 1 is set using an external resistor divider as shown in Table 1. Minimum output voltage is 1.5V and maximum output voltage is 5.5V. Typical maximum duty cycle is 85%.

$V_{OUT}(V)$	$R_4 = 6.04k\Omega$ $R_3 (k\Omega)$
1.5	9.09
1.8	12.1
1.85	12.4
2.0	14.0
2.5	19.1
3.0	24.3
3.3	27.4
5.0	44.2

Table 1: Feedback Resistor Values

Alternately, the feedback resistor may be calculated using the following equation:

$$R_3 = \frac{(V_{OUT} - 0.6) \cdot R_4}{0.6}$$

R3 is rounded to the nearest 1% resistor value.

Channel 1 Regulator Output Capacitor Selection

Two 22 μ F ceramic output capacitors are required to filter the inductor current ripple and supply the load transient current for $I_{OUT} = 2.5A$. The 1206 package with 10V minimum voltage rating is recommended for the output capacitors to maintain a minimum capacitance drop with DC bias.

Channel 1 Output Inductor Selection

The step-down converter utilizes constant frequency (PWM-mode) voltage mode control. A 4.7 μ H inductor value is selected to maintain the desired output current ripple and minimize the converter's response time to load transients. The peak switch current should not exceed the inductor saturation current, the MOSFET or the external Schottky rectifier peak current ratings.

Channel 1 Rectifier Selection

When the high-side switch is on, the input voltage will be applied to the cathode of the Schottky diode. The rectifier's rated reverse breakdown voltage must be chosen at least equal to the maximum input voltage of the step-down regulator.

When the high-side switch is off, the current will flow from the power ground to the output through the Schottky diode and the inductor. The power dissipation of the Schottky diode during the time-off can be determined by the following equation:

$$P_D = I_{OUT} \cdot V_D \cdot \left(1 - \frac{V_{OUT}}{V_{IN}}\right)$$

Where V_D is the voltage drop across the Schottky diode.

Channel 1 Input Capacitor Selection

For low cost applications, a 100 μ F/25V electrolytic capacitor is selected to control the voltage overshoot across the high side MOSFET. A small ceramic capacitor with voltage rating at least 1.05 times greater than the maximum input voltage is connected as close as possible to the input pin (Pin 14) for high frequency decoupling.

PMIC Solution for 12V Adapter Systems with 2-Output High Performance Step-Down Converters

Channel 1 Feedback and Compensation Networks

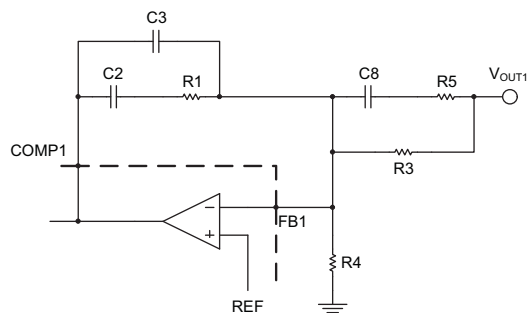

Figure 1: AAT2689 Feedback and Compensation Networks for Type III Voltage-Mode Control Loop.

The transfer function of the error amplifier is dominated by the DC gain and the L_{C_{OUT}} output filter of the regulator. This output filter and its equivalent series resistor (ESR) create a double pole at F_{LC} and a zero at F_{ESR} in the following equations:

$$\text{Eq. 1: } F_{LC} = \frac{1}{2 \cdot \pi \cdot \sqrt{L} \cdot C_{OUT}}$$

$$\text{Eq. 2: } F_{ESR} = \frac{1}{2 \cdot \pi \cdot ESR \cdot C_{OUT}}$$

The feedback and compensation networks provide a closed loop transfer function with the highest 0dB crossing frequency and adequate phase margin for system stability. Equation 3, 4, 5 and 6 relate the compensation network's poles and zeros to the components R1, R3, R5, C2, C3, and C8:

$$\text{Eq. 3: } F_{z1} = \frac{1}{2 \cdot \pi \cdot R_1 \cdot C_2}$$

$$\text{Eq. 4: } F_{z2} = \frac{1}{2 \cdot \pi \cdot (R_3 + R_5) \cdot C_8}$$

$$\text{Eq. 5: } F_{p1} = \frac{1}{2 \cdot \pi \cdot R_1 \cdot \left(\frac{C_2 \cdot C_3}{C_2 + C_3} \right)}$$

$$\text{Eq. 6: } F_{p2} = \frac{1}{2 \cdot \pi \cdot R_5 \cdot C_8}$$

Components of the feedback, feed-forward, compensation, and current limit networks need to be adjusted to maintain the systems stability for different input and output voltages applications as shown in Table 2.

Network	Components	V _{OUT} = 3.3V V _{IN} = 12V fixed	V _{OUT} = 3.3V V _{IN} = 6V to 24V	V _{OUT} = 5.0V V _{IN} = 6V to 24V
Feedback	R3	6.04kΩ	6.04kΩ	6.04kΩ
	R4	27.4kΩ	27.4kΩ	44.2kΩ
Feed-forward	C8	470pF	330pF	330pF
	R5	1.37kΩ	499Ω	499Ω
Compensation	C2	1nF	470pF	220pF
	C3	56pF	56pF	56pF
	R1	11.8kΩ	24.3kΩ	24.3kΩ
Current Limit	C7	22nF	220nF	220nF
	R2	10kΩ	2kΩ	2kΩ
	R6	Open	Open	Open
	R7	11kΩ	2kΩ	2kΩ
	R8	600kΩ	133kΩ	133kΩ

Table 2: AAT2689 Feedback, Feed-Forward, Compensation, and Current Limit Components for V_{OUT} = 3.3V and V_{OUT} = 5.0V.

PMIC Solution for 12V Adapter Systems with 2-Output High Performance Step-Down Converters

Channel 1 Thermal Protection

The AAT2689 has an internal thermal protection circuit which will turn on when the device die temperature exceeds 135°C. The internal thermal protection circuit will actively turn off the high side regulator output device to prevent the possibility of over temperature damage. The Buck regulator output will remain in a shutdown state until the internal die temperature falls back below the 135°C trip point. The combination and interaction between the short circuit and thermal protection systems allows the Buck regulator to withstand indefinite short-circuit conditions without sustaining permanent damage.

Over-Current Protection

The Output 1 controller provides true-load DC output current sensing which protects the load and limits component stresses. The output current is sensed through the DC resistance in the output inductor (DCR). The controller reduces the operating frequency when an over-current condition is detected; limiting stresses and preventing inductor saturation. This allows the smallest possible inductor for a given output load. A small resistor divider may be necessary to adjust the over-current threshold and compensate for variation in inductor DCR.

The preset current limit threshold is triggered when the differential voltage from RS1 to OS1 exceeds 100mV (nominal).

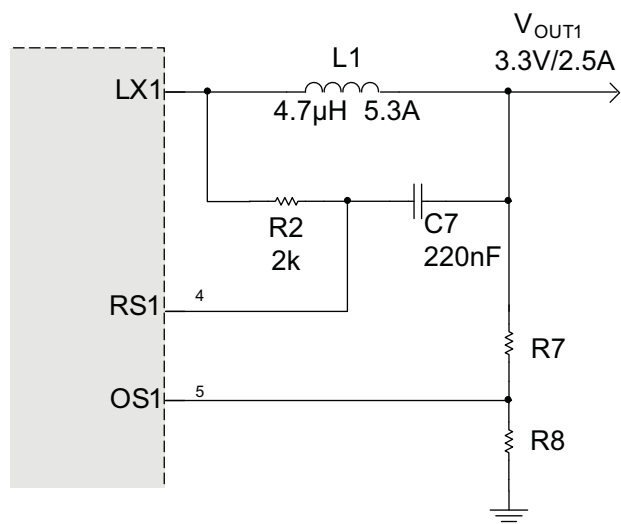

Figure 2: Resistor Network to Adjust the Current Limit Less than the Pre-Set Over-Current Threshold (Add R7, R8).

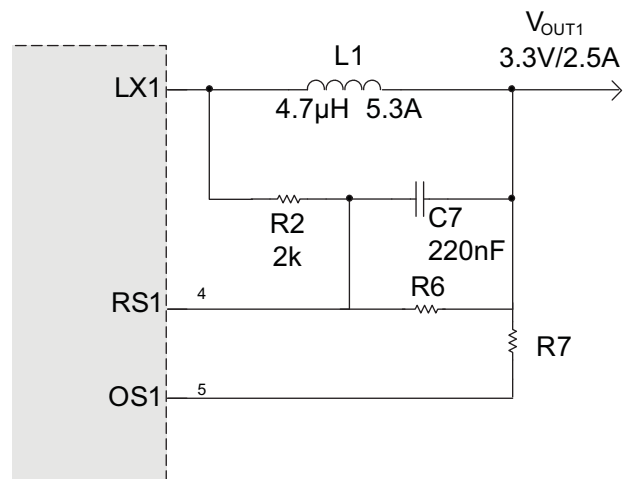

Figure 3: Resistor Network to Adjust the Current Limit Greater than the Pre-Set Over-Current Level (Add R6, R7).

Channel 2 Input Capacitor

Typically, a 1µF or larger capacitor is recommended for C_{IN} in most applications. A C_{IN} capacitor is not required for basic LDO regulator operation. However, if the AAT2689 is physically located more than three centimeters from an input power source, a C_{IN} capacitor will be needed for stable operation.

C_{IN} should be located as close to the device V_{IN} pin as possible. C_{IN} values greater than 1µF will offer superior input line transient response and will assist in maximizing the highest possible power supply ripple rejection. Ceramic, tantalum, or aluminum electrolytic capacitors may be selected for C_{IN} . There is no specific capacitor ESR requirement for C_{IN} . However, for 150mA LDO regulator output operation, ceramic capacitors are recommended for C_{IN} due to their inherent capability over tantalum capacitors to withstand input current surges from low impedance sources, such as batteries in portable devices.

Channel 2 Output Capacitor

For proper load voltage regulation and operational stability, a capacitor is required between pins VOUT and GND. The C_{OUT} capacitor connection to the LDO regulator ground pin should be connected as close as possible for maximum device performance. The AAT2689 LDO has been specifically designed to function with very low ESR ceramic capacitors. For best performance, ceramic capacitors are recommended.

PMIC Solution for 12V Adapter Systems with 2-Output High Performance Step-Down Converters

Typical output capacitor values for maximum output current conditions range from 1 μ F to 10 μ F. Applications utilizing the exceptionally low output noise and optimum power supply ripple rejection characteristics of channel 2 should use 2.2 μ F or greater for C_{OUT}. If desired, C_{OUT} may be increased without limit. In low output current applications where output load is less than 10mA, the minimum value for C_{OUT} can be as low as 0.47 μ F.

Channel 2 Enable Function

The AAT2689 features an LDO regulator enable/disable function. This pin (EN) is active high and is compatible with CMOS logic. To assure the LDO regulator will switch on, the EN turn-on control level must be greater than 1.5V. The LDO regulator will go into disable shutdown mode when the voltage on the EN pin falls below 0.6V. If the enable function is not needed in a specific application, it may be tied to V_{IN} to keep the LDO regulator in a continuously on state. When the LDO regulator is in shutdown mode, an internal 1.5k Ω resistor is connected between V_{OUT} and GND. This is intended to discharge C_{OUT} when the LDO regulator is disabled. The internal 1.5k Ω has no adverse effect on device turn-on time.

Channel 2 Short-Circuit Protection

The AAT2689 LDO contains an internal short-circuit protection circuit that will trigger when the output load current exceeds the internal threshold limit. Under short-circuit conditions, the output of the LDO regulator will be current limited until the short-circuit condition is removed from the output or LDO regulator package power dissipation exceeds the device thermal limit.

Channel 2 Thermal Protection

The AAT2689 LDO has an internal thermal protection circuit which will turn on when the device die temperature exceeds 150°C. The internal thermal protection circuit will actively turn off the LDO regulator output pass device to prevent the possibility of over temperature damage. The LDO regulator output will remain in a shutdown state until the internal die temperature falls back below the 150°C trip point. The combination and interaction between the short circuit and thermal protection systems allows the LDO regulator to withstand indefinite short-circuit conditions without sustaining permanent damage.

Channel 2 No-Load Stability

The AAT2689 is designed to maintain output voltage regulation and stability under operational no load conditions. This is an important characteristic for applications where the output current may drop to zero.

Channel 2 Reverse Output-to-Input Voltage Conditions and Protection

Under normal operating conditions, a parasitic diode exists between the output and input of the LDO regulator. The input voltage should always remain greater than the output load voltage, maintaining a reverse bias on the internal parasitic diode. Conditions where V_{OUT} might exceed V_{IN} should be avoided since this would forward bias the internal parasitic diode and allow excessive current flow into the V_{OUT} pin, possibly damaging the LDO regulator. In applications where there is a possibility of V_{OUT} exceeding V_{IN} for brief amounts of time during normal operation, the use of a larger value C_{IN} capacitor is highly recommended. A larger value of C_{IN} with respect to C_{OUT} will effect a slower C_{IN} decay rate during shutdown, thus preventing V_{OUT} from exceeding V_{IN}. In applications where there is a greater danger of V_{OUT} exceeding V_{IN} for extended periods of time, it is recommended to place a Schottky diode across V_{IN} to V_{OUT} (connecting the cathode to V_{IN} and anode to V_{OUT}). The Schottky diode forward voltage should be less than 0.45V.

Thermal Calculations

There are three types of losses associated with the AAT2689 step-down converter: switching losses, conduction losses, and quiescent current losses. Conduction losses are associated with the R_{DS(ON)} characteristics of the power output switching devices. Switching losses are dominated by the gate charge of the power output switching devices. At full load, assuming continuous conduction mode (CCM), a simplified form of the synchronous step-down converter and LDO losses is given by:

$$P_{\text{TOTAL}} = \frac{I_{\text{OUT1}}^2 \cdot (R_{\text{DS(ON)H}} \cdot V_{\text{OUT1}} + R_{\text{DS(ON)L}} \cdot [V_{\text{IN1}} - V_{\text{OUT1}}])}{V_{\text{IN1}}} + (t_{\text{SW}} \cdot F_{\text{S}} \cdot I_{\text{OUT1}} + I_{\text{Q1}}) \cdot V_{\text{IN1}} + (V_{\text{IN2}} - V_{\text{OUT2}}) \cdot I_{\text{OUT2}}$$

I_{Q1} and I_{Q2} are the step-down converter and LDO quiescent currents respectively. The term t_{SW} is used to estimate the full load step-down converter switching losses.

PMIC Solution for 12V Adapter Systems with 2-Output High Performance Step-Down Converters

For asynchronous step-down converter operation, the power dissipation is only in the internal high side MOSFET during the on time. When the switch is off, the power dissipates on the external Schottky diode. Total package loss for AAT2689 reduces to the following equation:

$$P_{\text{TOTAL}} = I_{\text{OUT1}}^2 \cdot R_{\text{DS(ON)H}} \cdot D + (t_{\text{SW}} \cdot F_{\text{S}} \cdot I_{\text{OUT1}} + I_{\text{Q1}}) \cdot V_{\text{IN1}} + (V_{\text{IN2}} - V_{\text{OUT2}}) \cdot I_{\text{OUT2}}$$

where $D = \frac{V_{\text{OUT}}}{V_{\text{IN}}}$ is the duty cycle.

Since $R_{\text{DS(ON)}}$, quiescent current, and switching losses all vary with input voltage, the total losses should be investigated over the complete input voltage range.

Given the total losses, the maximum junction temperature can be derived from the θ_{JA} for the TDFN34-16 package, which is 50°C/W.

$$T_{\text{J(MAX)}} = P_{\text{TOTAL}} \cdot \theta_{\text{JA}} + T_{\text{AMB}}$$

Layout Considerations

The suggested PCB layout for the AAT2689 is shown in Figures 4, 5, and 6. The following guidelines should be used to help ensure a proper layout.

1. The power input capacitors (C1 and C15) should be connected as close as possible to high voltage input pin (IN1) and power ground.
2. C1, L1, D2, C9 and C11 should be placed as close as possible to minimize any parasitic inductance in the switched current path which generates a large voltage spike during the switching interval. The connection of inductor to switching node should be as short as possible.
3. The feedback trace or FB1 pin should be separated from any power trace and connected as close as possible to the load point. Sensing along a high-current load trace will degrade DC load regulation.
4. The resistance of the trace from the load returns to PGND should be kept to a minimum. This will help to minimize any error in DC regulation due to differences in the potential of the internal signal ground and the power ground.
5. Connect unused signal pins to ground to avoid unwanted noise coupling.
6. The critical small signal components include feedback components, and compensation components should be placed close to the FB1 and COMP1 pins. The feedback resistors should be located as close as possible to the FB1 pin with its ground tied straight to the signal ground plane which is separated from power ground plane.
7. C7 should be connected close to the RS1 and OS1 pins, while R2 should be connected directly to the output pin of the inductor. For the best current limit performance, C7 and R2 should be placed on the bottom layer to avoid noise coupling from the inductor.
8. For good thermal coupling, PCB vias are required from exposed pad 1 (EP1) to the bottom ground plane and from exposed pad 2 (EP2) to the bottom VIN plane.

AAT2689

PMIC Solution for 12V Adapter Systems with 2-Output High Performance Step-Down Converters

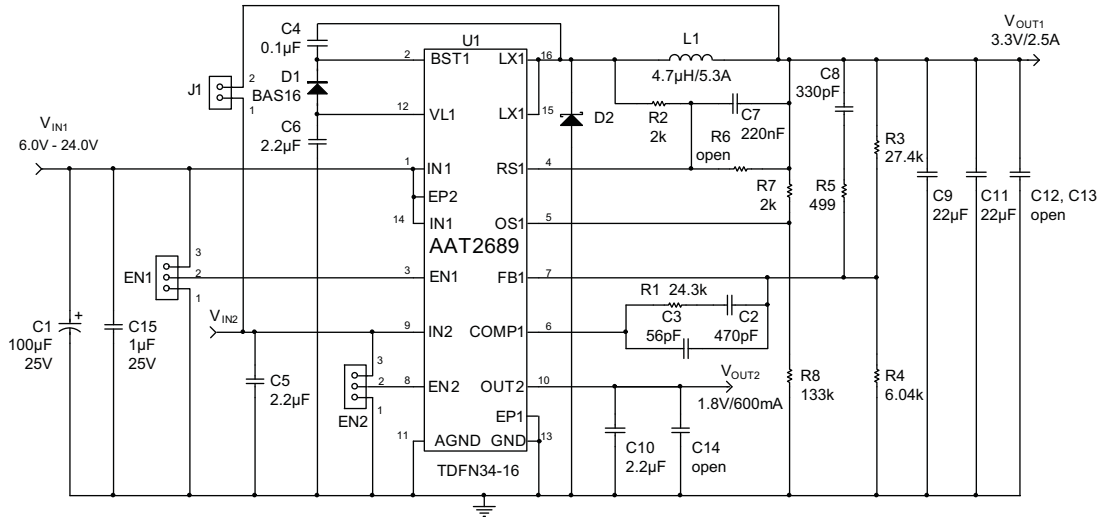

- | | |
|----------------|--|
| U1 | AAT2689 Skyworks, Hi-Voltage Buck/LDO, TDFN34-16 |
| C1 | Cap, MLC, 100µF/25V, Electrolytic cap |
| C5, C6, C10 | Cap, MLC, 2.2µF, 6.3V, 0805 |
| C4 | Cap, MLC, 0.1µF/6.3V, 0603 |
| C2, C3, C7, C8 | Cap, MLC, misc., 0603 |
| C9, C11 | Cap, MLC, 22µF/10V, 1206 |
| D1 | BAS16, Generic, Rectifier, 0.2A/85V, Ultrafast, SOT23 |
| D2 | B340A, Generic, Schottky Rectifier, 3A/40V, SMA |
| L1 | RCH108NP-4R7M, 4.7µH, I _{SAT} = 5.3A, DCR = 11.7mΩ or Würth 744 778 900 4, 4.7µH, I _{SAT} = 3.9A, DCR = 35mΩ |
| R1 - R8 | Carbon film resistor, 0402 |
| C15 | Cap, MLC, 1µF/25V, 0603 |

Figure 4: AAT2689IRN Evaluation Board Schematic For $V_{IN} = 6V$ to $24V$ and $V_{OUT} = 3.3V$.

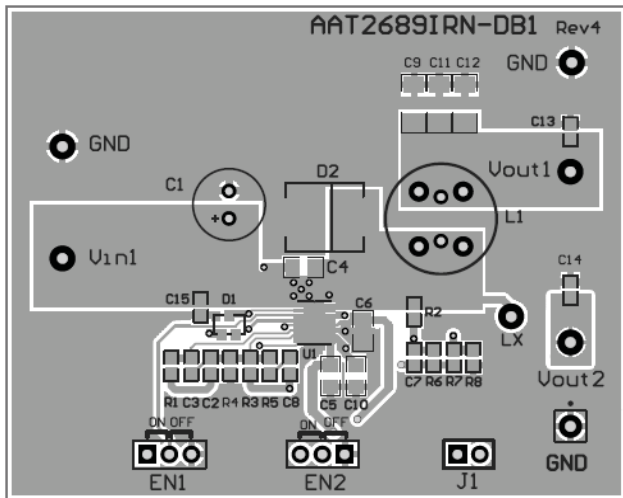

Figure 5: AAT2689IRN Evaluation Board Top Layer.

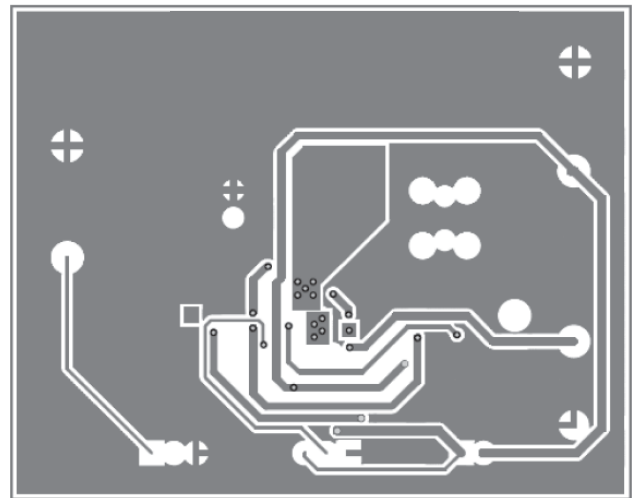

Figure 6: AAT2689IRN Evaluation Board Bottom Layer.

**PMIC Solution for 12V Adapter Systems
with 2-Output High Performance Step-Down Converters**

AAT2689 Design Example

Specifications

$$V_{O1} = 3.3V @ 2.5A, \text{ Pulsed Load } \Delta I_{LOAD} = 2.5A$$

$$V_{O2} = 1.8V @ 600mA$$

$$V_{IN1} = 12V$$

$$F_S = 490kHz$$

$$T_{AMB} = 85^\circ C \text{ in TDFN34-16 Package}$$

Channel 1 Output Inductor

For Sumida inductor RCH108NP-4R7M, 4.7 μ H, DCR = 11.7m Ω max.

$$\Delta I = \frac{V_{OUT1}}{L_1 \cdot F_S} \cdot \left(1 - \frac{V_{OUT1}}{V_{IN}}\right) = \frac{3.3V}{4.7\mu H \cdot 490kHz} \cdot \left(1 - \frac{3.3V}{12V}\right) = 1A$$

$$I_{PK1} = I_{OUT1} + \frac{\Delta I}{2} = 2.5A + 1A = 3.5A$$

$$P_{L1} = I_{OUT1}^2 \cdot DCR = 3.5A^2 \cdot 11.7m\Omega = 143mW$$

Channel 1 Output Capacitor

$$V_{DROOP} = 0.33V \text{ (10\% Output Voltage)}$$

$$C_{OUT} = \frac{3 \cdot \Delta I_{LOAD}}{V_{DROOP} \cdot F_S} = \frac{3 \cdot 2.5A}{0.33V \cdot 490kHz} = 46.4\mu F; \text{ use } 2 \times 22\mu F$$

$$I_{RMS(MAX)} = \frac{1}{2 \cdot \sqrt{3}} \cdot \frac{V_{OUT1} \cdot (V_{IN(MAX)} - V_{OUT1})}{L \cdot F_S \cdot V_{IN1(MAX)}} = \frac{1}{2 \cdot \sqrt{3}} \cdot \frac{3.3V \cdot (24V - 3.3V)}{4.7\mu H \cdot 490kHz \cdot 24V} = 357mA_{RMS}$$

$$P_{RMS} = ESR \cdot I_{RMS}^2 = 11.7m\Omega \cdot (357mA)^2 = 1.5W$$

Channel 1 Input Capacitor

$$\text{Input Ripple } V_{PP} = 25mV$$

$$C_{IN1} = \frac{1}{\left(\frac{V_{PP1}}{I_{OUT1}} - ESR\right) \cdot 4 \cdot F_S} = \frac{1}{\left(\frac{25mV}{2.5A} - 5m\Omega\right) \cdot 4 \cdot 490kHz} = 102\mu F$$

For low cost applications, 100 μ F/25V electrolytic capacitor in parallel with 1 μ F/25V ceramic capacitor are used to reduce the ESR.

$$I_{RMS} = \frac{I_{OUT1}}{2} = 1.25A$$

$$P = ESR \cdot (I_{RMS})^2 = 5m\Omega \cdot (1.25A)^2 = 7.8mW$$

**PMIC Solution for 12V Adapter Systems
with 2-Output High Performance Step-Down Converters**

Channel 1 Current Limit

Voltage sense $V_S = 100\text{mV}$

Total trace parasitic resistor and inductor DCR is $10\text{m}\Omega$

$$I_{\text{LIM}} = \frac{V_S}{\text{DCR}} = \frac{100\text{mV}}{10\text{m}\Omega} = 10\text{A} > 5\text{A}$$

$$R_8 = \frac{V_{\text{OUT1}} \cdot R_2}{V_{\text{OCP}} - I_{\text{LIMIT}} \cdot \text{DCR}} = \frac{3.3\text{V} \cdot 2\text{k}\Omega}{0.1\text{V} - 5\text{A} \cdot 10\text{m}\Omega} = 133\text{k}\Omega$$

$$R_7 = \frac{R_2 \cdot R_8}{R_8 - R_2} = \frac{2\text{k}\Omega \cdot 133\text{k}\Omega}{133\text{k}\Omega - 2\text{k}\Omega} = 2\text{k}\Omega$$

AAT2689 Losses

All values assume a 25°C ambient temperature and thermal resistance of $50^\circ\text{C}/\text{W}$ in the TDFN34-16 package.

$$P_{\text{TOTAL}} = I_{\text{OUT1}}^2 \cdot R_{\text{DS(ON)H}} \cdot D + (t_{\text{SW}} \cdot F_S \cdot I_{\text{OUT1}} + I_{\text{Q1}}) \cdot V_{\text{IN1}} + (V_{\text{IN2}} - V_{\text{OUT2}}) \cdot I_{\text{OUT2}}$$

$$P_{\text{TOTAL}} = \frac{2.5\text{A}^2 \cdot 70\text{m}\Omega \cdot 3.3\text{V}}{12\text{V}} + (5\text{ns} \cdot 490\text{kHz} \cdot 2.5\text{A} + 70\mu\text{A}) \cdot 12\text{V} \cdot (3.3\text{V} - 1.8\text{V}) \cdot 600\text{mA}$$

$$P_{\text{TOTAL}} = 1.1\text{W}$$

$$T_{\text{J(MAX)}} = T_{\text{AMB}} + \Theta_{\text{JA}} \cdot P_{\text{LOSS}} = 25^\circ\text{C} + (50^\circ\text{C}/\text{W}) \cdot 1.1\text{W} = 80^\circ\text{C}$$

AAT2689

PMIC Solution for 12V Adapter Systems with 2-Output High Performance Step-Down Converters

Ordering Information

Package	Voltage		Marking ¹	Part Number (Tape and Reel) ²
	Channel 1	Channel 2		
TDFN34-16	Adj (0.6)	1.8	3PXY	AAT2689IRN-AI-T1



Skyworks Green™ products are compliant with all applicable legislation and are halogen-free.

For additional information, refer to *Skyworks Definition of Green™*, document number

SQ04-0074.

Legend	
Voltage	Code
Adjustable (0.6)	A
1.8	I

1. XYY = assembly and date code.

2. Sample stock is generally held on part numbers listed in **BOLD**.

PMIC Solution for 12V Adapter Systems with 2-Output High Performance Step-Down Converters

Package Information¹

TDFN34-16

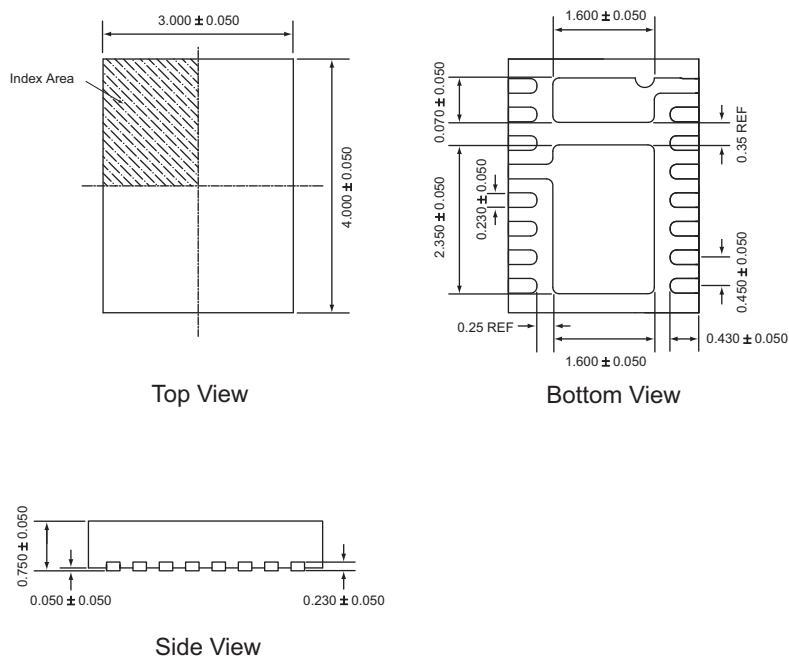

All dimensions in millimeters.

- The leadless package family, which includes QFN, TQFN, DFN, TDFN and STDFN, has exposed copper (unplated) at the end of the lead terminals due to the manufacturing process. A solder fillet at the exposed copper edge cannot be guaranteed and is not required to ensure a proper bottom solder connection.

Copyright © 2012 Skyworks Solutions, Inc. All Rights Reserved.

Information in this document is provided in connection with Skyworks Solutions, Inc. ("Skyworks") products or services. These materials, including the information contained herein, are provided by Skyworks as a service to its customers and may be used for informational purposes only by the customer. Skyworks assumes no responsibility for errors or omissions in these materials or the information contained herein. Skyworks may change its documentation, products, services, specifications or product descriptions at any time, without notice. Skyworks makes no commitment to update the materials or information and shall have no responsibility whatsoever for conflicts, incompatibilities, or other difficulties arising from any future changes.

No license, whether express, implied, by estoppel or otherwise, is granted to any intellectual property rights by this document. Skyworks assumes no liability for any materials, products or information provided hereunder, including the sale, distribution, reproduction or use of Skyworks products, information or materials, except as may be provided in Skyworks Terms and Conditions of Sale.

THE MATERIALS, PRODUCTS AND INFORMATION ARE PROVIDED "AS IS" WITHOUT WARRANTY OF ANY KIND, WHETHER EXPRESS, IMPLIED, STATUTORY, OR OTHERWISE, INCLUDING FITNESS FOR A PARTICULAR PURPOSE OR USE, MERCHANTABILITY, PERFORMANCE, QUALITY OR NON-INFRINGEMENT OF ANY INTELLECTUAL PROPERTY RIGHT; ALL SUCH WARRANTIES ARE HEREBY EXPRESSLY DISCLAIMED. SKYWORKS DOES NOT WARRANT THE ACCURACY OR COMPLETENESS OF THE INFORMATION, TEXT, GRAPHICS OR OTHER ITEMS CONTAINED WITHIN THESE MATERIALS. SKYWORKS SHALL NOT BE LIABLE FOR ANY DAMAGES, INCLUDING BUT NOT LIMITED TO ANY SPECIAL, INDIRECT, INCIDENTAL, STATUTORY, OR CONSEQUENTIAL DAMAGES, INCLUDING WITHOUT LIMITATION, LOST REVENUES OR LOST PROFITS THAT MAY RESULT FROM THE USE OF THE MATERIALS OR INFORMATION, WHETHER OR NOT THE RECIPIENT OF MATERIALS HAS BEEN ADVISED OF THE POSSIBILITY OF SUCH DAMAGE.

Skyworks products are not intended for use in medical, lifesaving or life-sustaining applications, or other equipment in which the failure of the Skyworks products could lead to personal injury, death, physical or environmental damage. Skyworks customers using or selling Skyworks products for use in such applications do so at their own risk and agree to fully indemnify Skyworks for any damages resulting from such improper use or sale.

Customers are responsible for their products and applications using Skyworks products, which may deviate from published specifications as a result of design defects, errors, or operation of products outside of published parameters or design specifications. Customers should include design and operating safeguards to minimize these and other risks. Skyworks assumes no liability for applications assistance, customer product design, or damage to any equipment resulting from the use of Skyworks products outside of stated published specifications or parameters.

Skyworks, the Skyworks symbol, and "Breakthrough Simplicity" are trademarks or registered trademarks of Skyworks Solutions, Inc., in the United States and other countries. Third-party brands and names are for identification purposes only, and are the property of their respective owners. Additional information, including relevant terms and conditions, posted at www.skyworksinc.com, are incorporated by reference.