

# IoT OPTIMIZED LOW PROFILE QUARTZ CRYSTAL

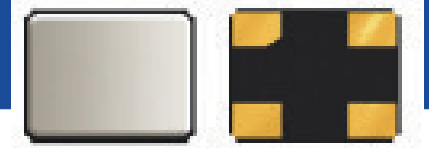

2.5 x 2.0 x 0.6mm

RoHS/RoHS II Compliant

MSL = N/A: NOT APPLICABLE

## ABM10W SERIES

### FEATURES

- Optimized for energy saving wearables and IoT applications
- Plated at exceptionally low plating capacitance, as low as 4pF, with optimized ESR
- 0.6 mm max height ideally suited for height constrained designs
- Seam sealed for longterm reliability

### APPLICATIONS

- Wearables
- Internet of Things (IoT)
- Bluetooth/Bluetooth Low Energy (BLE)
- Wireless modules
- Machine-to-machine (M2M) connectivity
- Ultra-low power MCU
- Near Field Communication (NFC)
- ISM Band

### STANDARD SPECIFICATIONS

Parameters	Minimum	Typical	Maximum	Units	Notes
Frequency Range	16.0000		50.0000	MHz	
Operation Mode	Fundamental				
Operating Temperature Range	-40		+125	°C	See options
Storage Temperature	-55		+125	°C	
Frequency Tolerance @ +25°C	-10		+10	ppm	See options
Frequency Stability over the Operating Temperature ( ref. to +25°C)	-10		+10	ppm	See options
Equivalent series resistance (R1) (over -40°C to +125°C)		< 70	100	Ω	16.0000 – 19.9999MHz
		< 50	80		20.0000 – 29.9999MHz
		< 40	60		30.0000 – 39.9999MHz
		< 25	40		40.0000 – 50.0000MHz
Shunt capacitance (C0)		< 1.0	2.0	pF	
Load capacitance (CL)		4.0		pF	See options
Drive Level		10	100	μW	
Aging (1 year)	-2		+2	ppm	@ 25°C±3°C
Insulation Resistance	500			MΩ	@ 100Vdc ± 15V

# IoT OPTIMIZED LOW PROFILE QUARTZ CRYSTAL

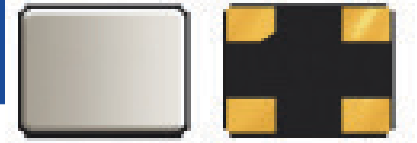

2.5 x 2.0 x 0.6mm



RoHS/RoHS II Compliant

MSL = N/A: NOT APPLICABLE

## ABM10W SERIES

### OPTIONS AND PART IDENTIFICATION (NOTE 1)

Note 1: Contact Abracon for part number requests with carrier frequency callouts up to 5 & 6 digit accuracy after the decimal.

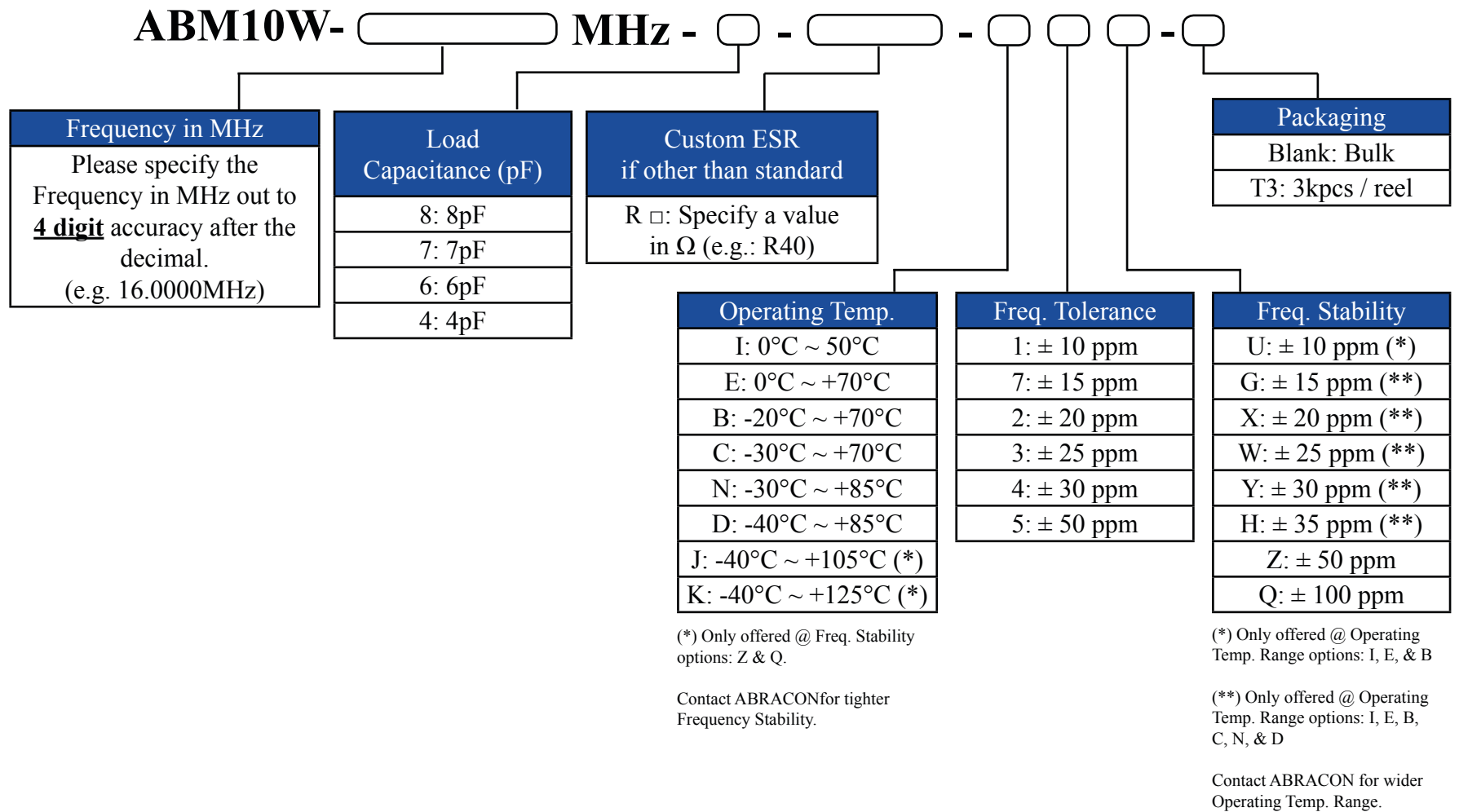

# IoT OPTIMIZED LOW PROFILE QUARTZ CRYSTAL

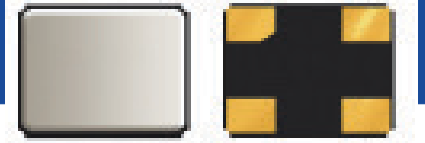

2.5 x 2.0 x 0.6mm



RoHS/RoHS II Compliant

MSL = N/A: NOT APPLICABLE

## ABM10W SERIES

### TYPICAL FREQUENCY Vs. TEMPERATURE CHARACTERISTICS

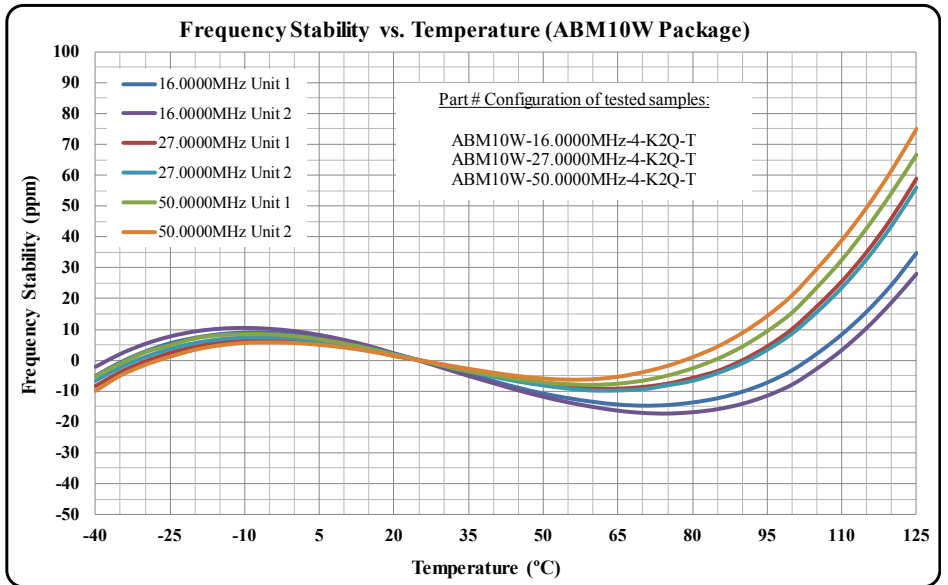
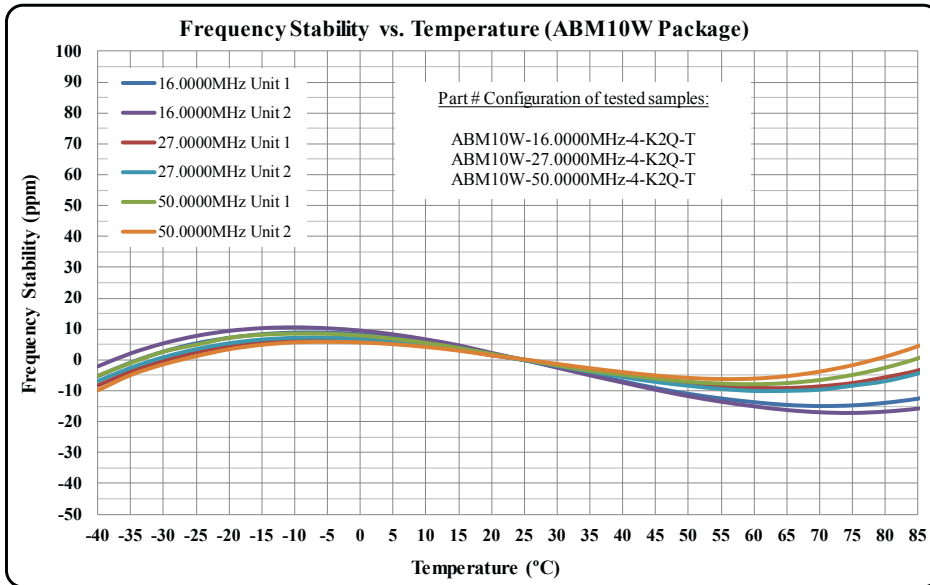

### TYPICAL ESR (EQUIVALENT SERIES RESISTANCE) Vs. TEMPERATURE CHARACTERISTICS

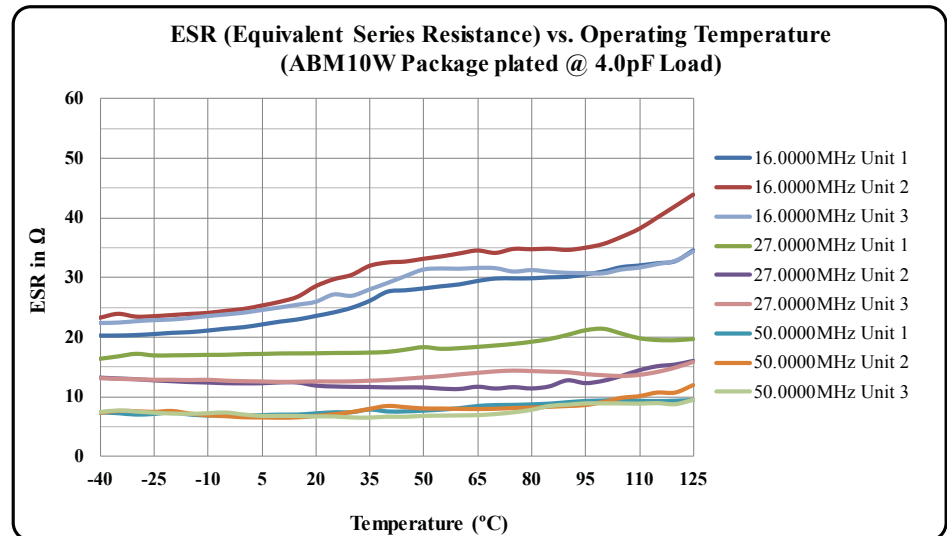
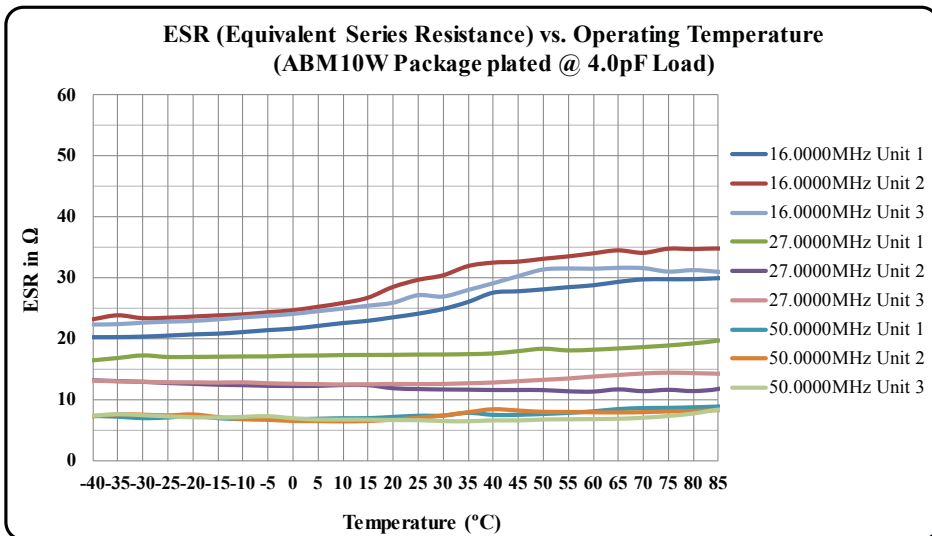

# IoT OPTIMIZED LOW PROFILE QUARTZ CRYSTAL



ABM10W SERIES

2.5 x 2.0 x 0.6mm



RoHS/RoHS II Compliant

MSL = N/A: NOT APPLICABLE

## TYPICAL FREQUENCY TOLERANCE DISTRIBUTION (AT 25°C ± 3°C)

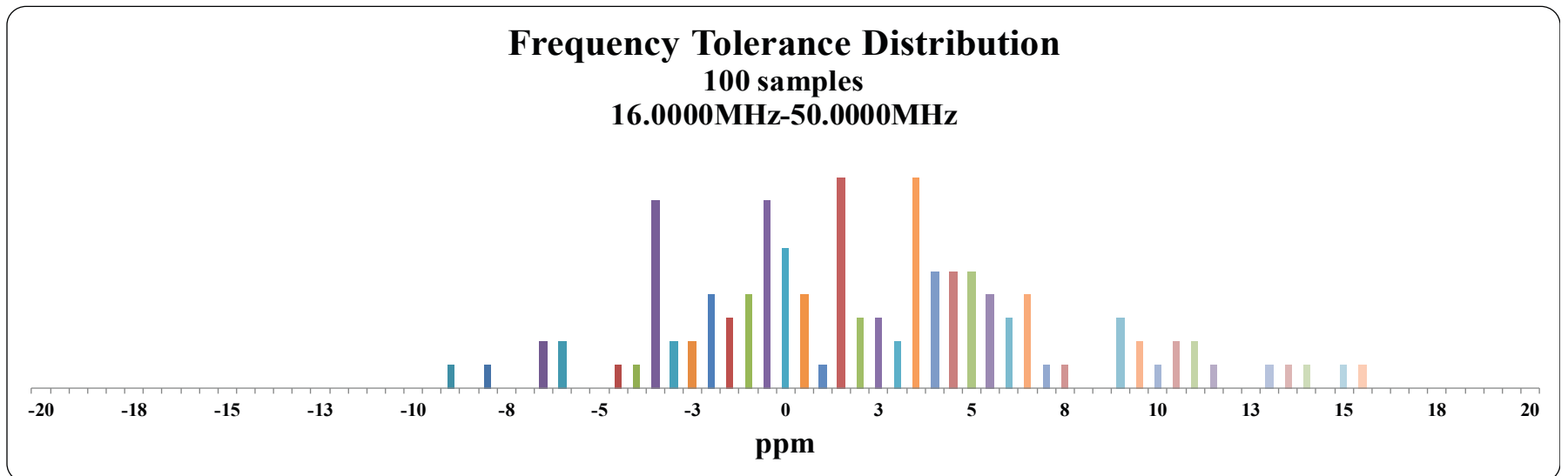

## TYPICAL ESR DISTRIBUTION (AT 25°C ± 3°C)

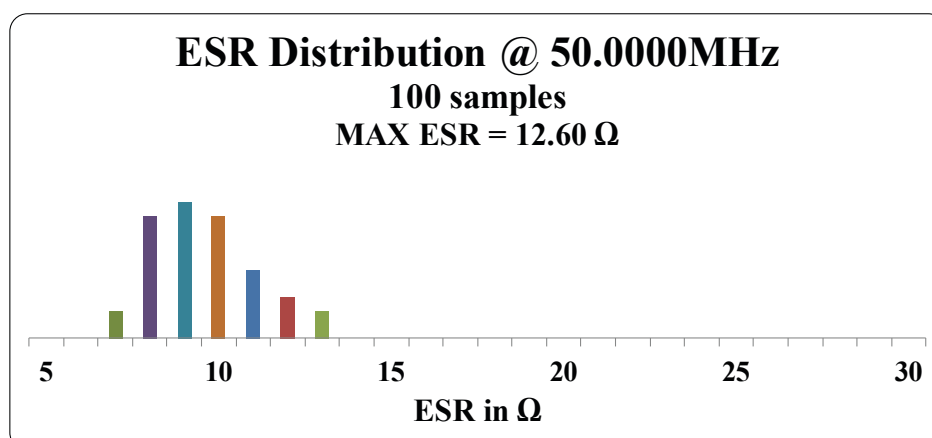
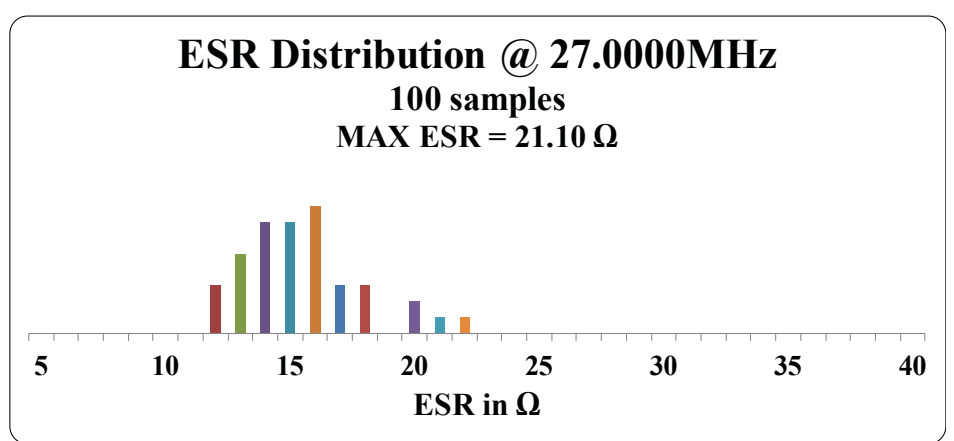
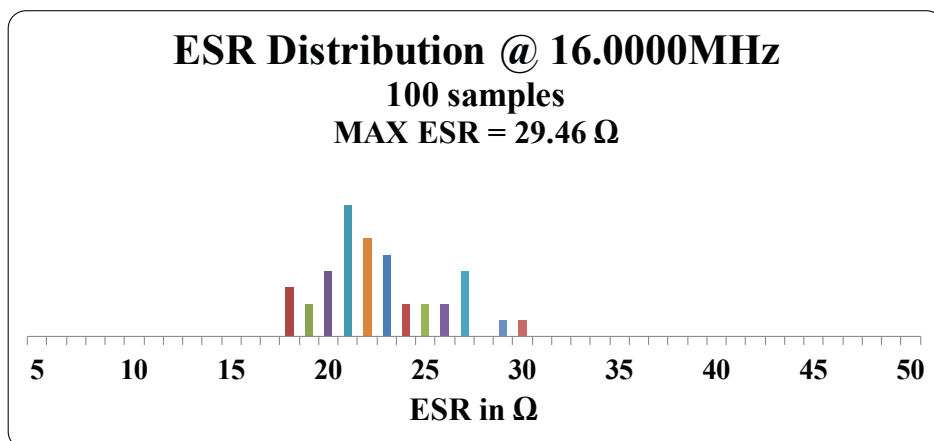

# IoT OPTIMIZED LOW PROFILE QUARTZ CRYSTAL

ABM10W SERIES



2.5 x 2.0 x 0.6mm



RoHS/RoHS II Compliant

MSL = N/A: NOT APPLICABLE

## SPICE MODELS (BASED ON TYPICAL VALUES AT 25°C ± 3°C)

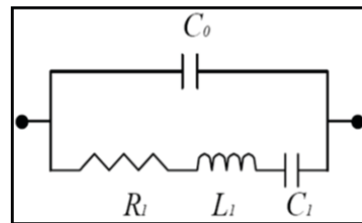

<b>Frequency: 16.0000MHz</b> <b>Plating Load: 4pF</b>		<b>Frequency: 16.0000MHz</b> <b>Plating Load: 6pF</b>	
C0	= 0.65 pF	C0	= 0.65 pF
R1	= 22.77 Ω	R1	= 21.43 Ω
L1	= 70.34 mH	L1	= 70.13 mH
C1	= 1.41 fF	C1	= 1.41 fF
<b>Frequency: 27.0000MHz</b> <b>Plating Load: 4pF</b>		<b>Frequency: 27.0000MHz</b> <b>Plating Load: 6pF</b>	
C0	= 0.65 pF	C0	= 0.66 pF
R1	= 14.39 Ω	R1	= 17.38 Ω
L1	= 16.51 mH	L1	= 16.56 mH
C1	= 2.11 fF	C1	= 2.10 fF
<b>Frequency: 50.0000MHz</b> <b>Plating Load: 4pF</b>		<b>Frequency: 50.0000MHz</b> <b>Plating Load: 6pF</b>	
C0	= 0.89 pF	C0	= 0.87 pF
R1	= 8.40 Ω	R1	= 8.03 Ω
L1	= 3.24 mH	L1	= 3.19 mH
C1	= 3.13 fF	C1	= 3.18 fF

## MECHANICAL DIMENSIONS

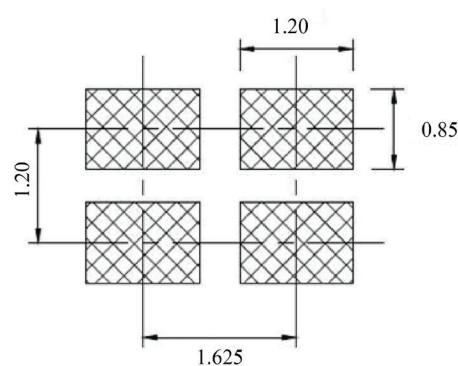
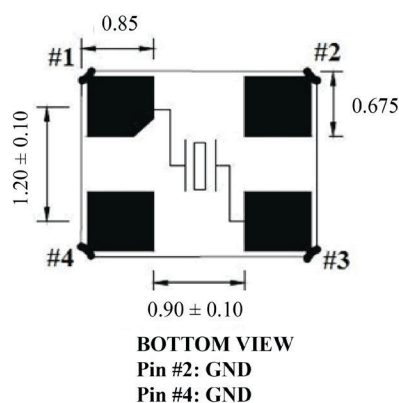
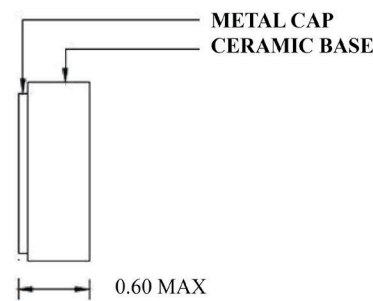
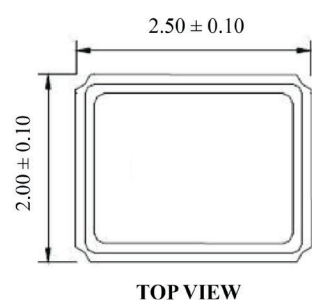

DIMENSIONS: mm

DIMENSIONS: mm

### Note:

Due to material availability the Chamfer could be located on pin #1, 2 or 4. Be advised that the Chamfer location has no impact on the electrical performance of the device.

# IoT OPTIMIZED LOW PROFILE QUARTZ CRYSTAL



ABM10W SERIES

2.5 x 2.0 x 0.6mm

RoHS/RoHS II Compliant  
MSL = N/A: NOT APPLICABLE

## REFLOW PROFILE

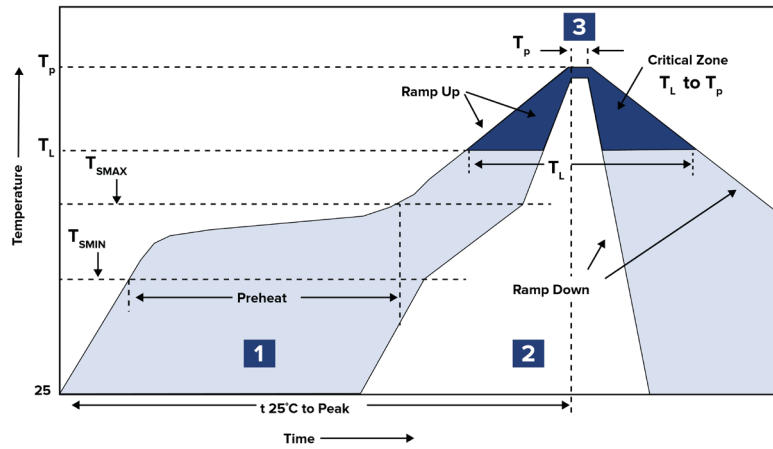

Zone	Description	Temperature	Time
1	Preheat	$T_{SMIN} \sim T_{SMAX}$ 150°C ~ 180°C	60 ~ 120 sec.
2	Reflow	$T_L$ 217°C	45 ~ 90 sec.
3	Peak Heat	$T_P$ 260°C MAX	10 sec.

## PACKAGING

T3: Tape and reel (3,000 pcs/reel)

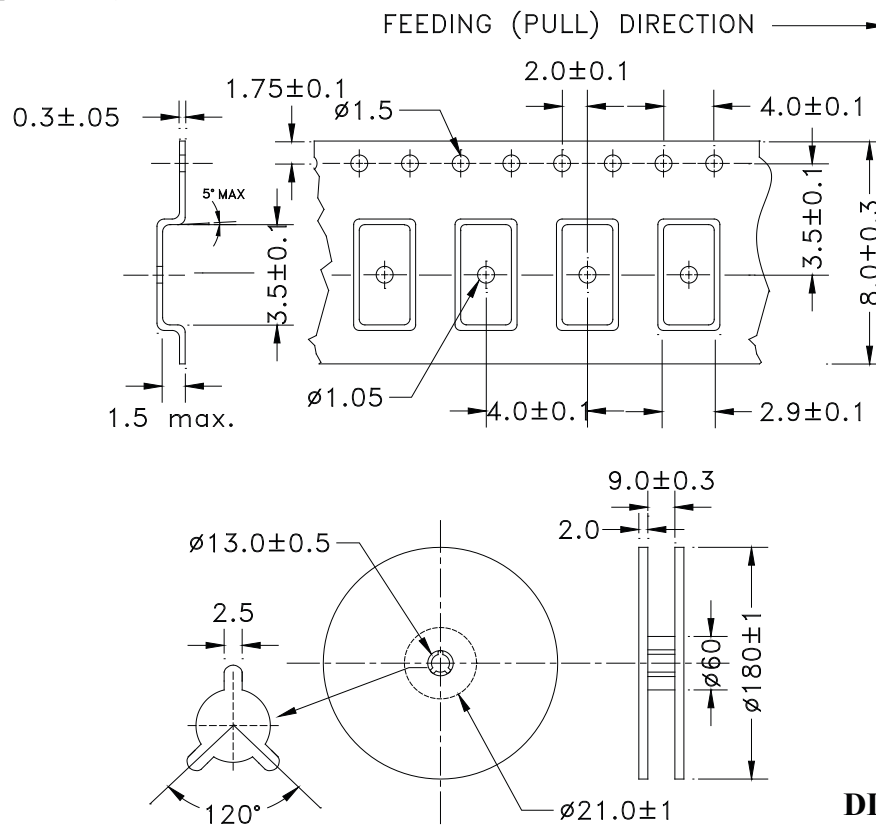

DIMENSIONS: mm

REVISED: 08.09.2018

**ABRACON**<sup>®</sup>  
LLC  
The Heartbeat of the IoT™

5101 Hidden Creek Ln Spicewood TX 78669  
Phone: 512-371-6159 | Fax: 512-351-8858  
For terms and conditions of sales, please visit:  
www.abracon.com

ABRACON IS  
ISO9001-2015  
CERTIFIED