

**ABS2U THRU ABS10U**  
**SINGLE PHASE 1.0AMP SURFACE MOUNT GLASS PASSIVATED BRIDGE RECTIFIER**

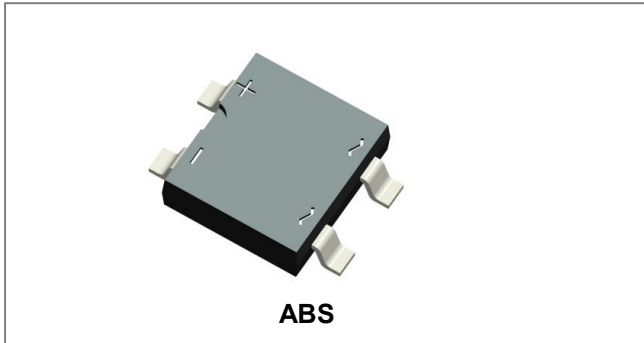

**Features**

- Glass passivated die construction
- Low forward voltage drop
- High current capability
- High surge current capability
- Designed for surface mount application
- Plastic material-UL flammability 94V-0
- This is a Pb – Free Device
- “-HF” suffix is for Halogen Free Device
- All SMC parts are traceable to the wafer lot
- Additional testing can be offered upon request

**Circuit Diagram**

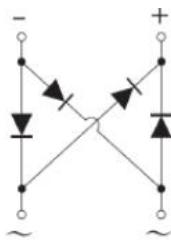

**Mechanical Data**

- Case: SOPA-4, Molded plastic ABS
- Terminals: Plated leads solderable per MIL-STD-202, Method 208
- Polarity: as marked on case
- Mounting Position: Any

**Maximum Ratings and Electrical Characteristics @T<sub>A</sub>=25°C unless otherwise specified**

Single Phase half wave 60Hz, resistive or inductive load. For capacitive load current derate by 20%.

Type Number	Symbol	ABS2U	ABS4U	ABS6U	ABS8U	ABS10U	Units	
ABS2U-HF THRU ABS10U-HF Marking Code		ABS2UH	ABS4UH	ABS6UH	ABS8UH	ABS10UH	Units	
Peak Repetitive Reverse Voltage Working Peak Reverse Voltage DC Blocking Voltage	V <sub>RRM</sub> V <sub>RWM</sub> V <sub>DC</sub>	200	400	600	800	1000	V	
RMS Reverse Voltage	V <sub>RMS</sub>	140	280	420	560	700	V	
Maximum Average Rectified Output Current @T <sub>A</sub> =30°C	I <sub>(AV)</sub>	1						V
Non-Repetitive Peak Forward Surge Current 8.3ms Single half sine-wave superimposed on rated load (JEDEC Method)	I <sub>FSM</sub>	35						A

**Electrical Characteristics @  $T_A=25^\circ\text{C}$  unless otherwise specified**

Type Number	Symbol	ABS2U	ABS4U	ABS6U	ABS8U	ABS10U	Units
ABS2U-HF THRU ABS10U-HF Marking Code		ABS2UH	ABS4UH	ABS6UH	ABS8UH	ABS10UH	Units
Maximum Forward Voltage (per element) @ $I_F = 1\text{A}$	$V_F$	1.1					V
Maximum Peak Reverse Current @ $T_A = 25^\circ\text{C}$ At Rated DC Blocking Voltage @ $T_A = 125^\circ\text{C}$	$I_R$	5.0 500					$\mu\text{A}$

\* Pulse width < 300  $\mu\text{s}$ , duty cycle < 2%

**Thermal-Mechanical Specifications @  $T_A=25^\circ\text{C}$  unless otherwise specified**

Type Number	Symbol	ABS2U	ABS4U	ABS6U	ABS8U	ABS10U	Units
ABS2U-HF THRU ABS10U-HF Marking Code		ABS2UH	ABS4UH	ABS6UH	ABS8UH	ABS10UH	Units
Typical Thermal Resistance(Note 1)	$R_{\theta JA}$ $R_{\theta JL}$	62.5 25					$^\circ\text{C/W}$
Operating and Storage Temperature Range	$T_J, T_{STG}$	-55 to +150					$^\circ\text{C}$

Note: 1. Thermal resistance from junction to ambient and junction to lead mounted on P.C.B. with 0.2X0.2"(5X5mm) copper pads.

**Ratings and Characteristics Curves**

FIG. 1 MAXIMUM FORWARD CURRENT DERATING CURVE

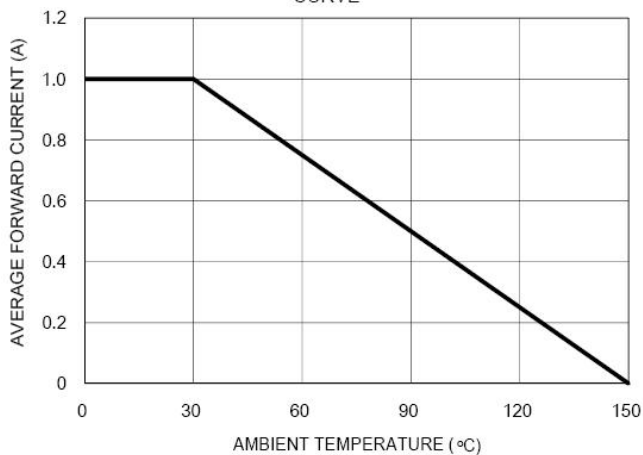
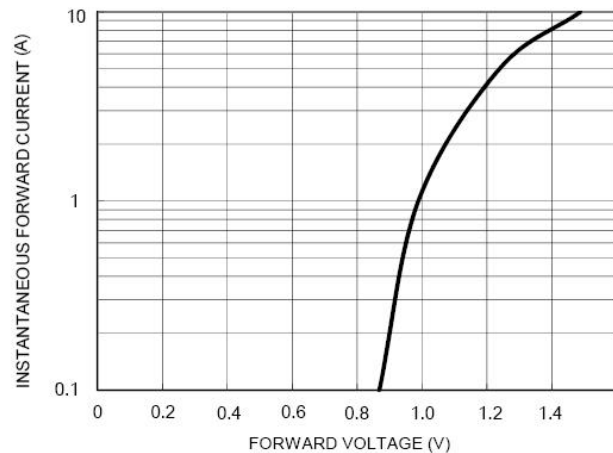
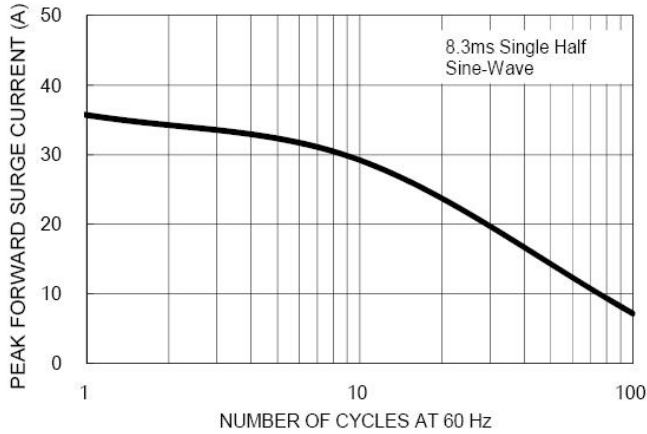

FIG. 2 TYPICAL FORWARD CHARACTERISTIC



**FIG. 3 MAXIMUM NON-REPETITIVE FORWARD SURGE CURRENT**



**FIG. 4 TYPICAL REVERSE CHARACTERISTICS**

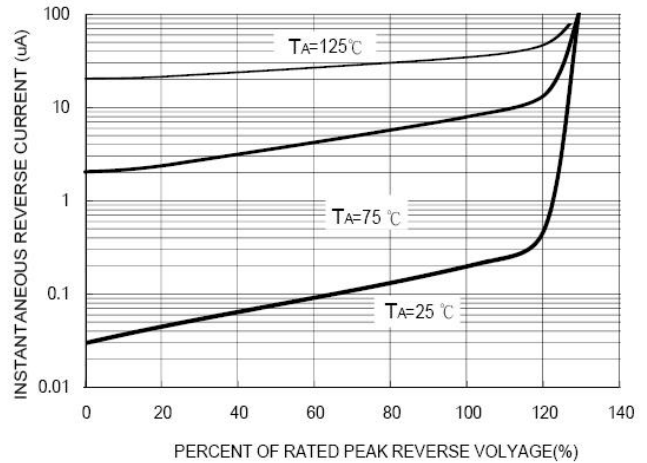

**Mechanical Dimensions ABS(Inches/Millimeters)**

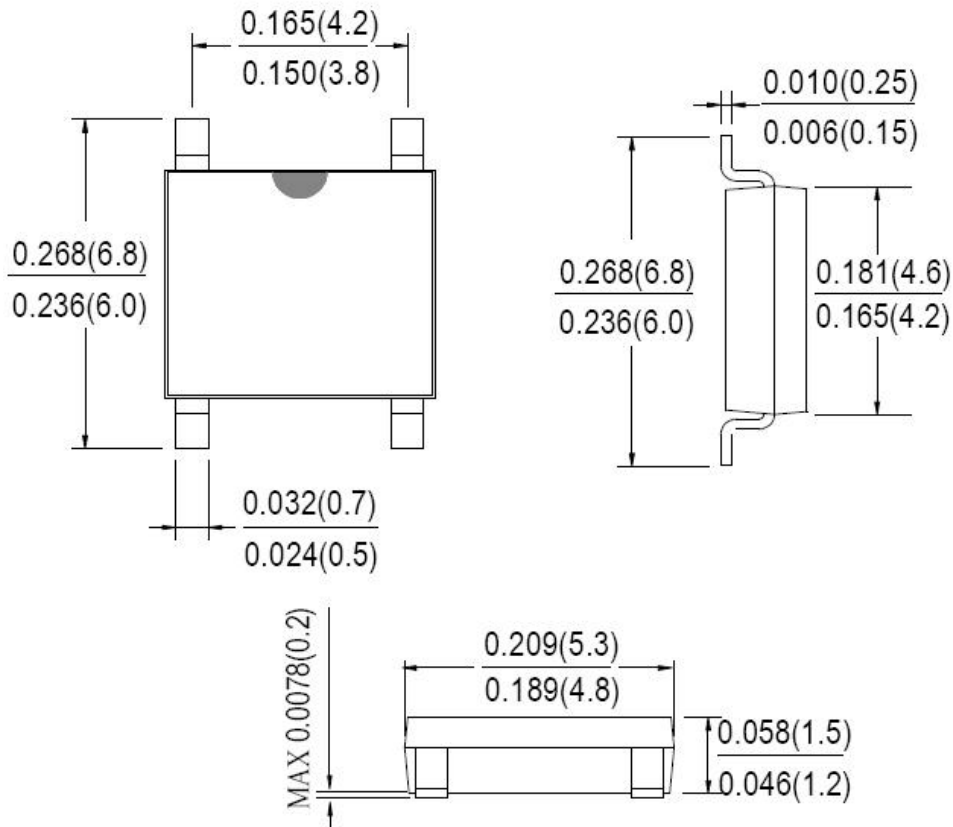

## Ordering Information

Device	Package	Plating	Shipping
ABS2U THRU ABS10U	ABS	Pure Sn	5000pcs / reel
ABS2UTR THRU ABS10UTR	ABS	Pure Sn	5000pcs / reel

For information on tape and reel specifications, including part orientation and tape sizes, please refer to our tape and reel packaging specification.

## Marking Diagram

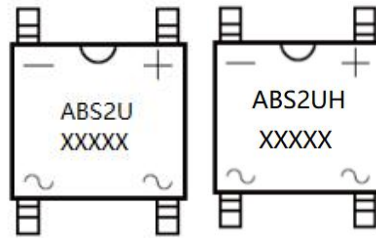

ABS2U

ABS2U-HF

Where XXXXX is YYWWL

ABS2U = Type Number  
ABS2UH = Marking Code  
YY = Year  
WW = Week  
L = Lot Number

**Cautions:** Molding resin  
Epoxy resin UL:94V-0

## Carrier Tape Specification ABS

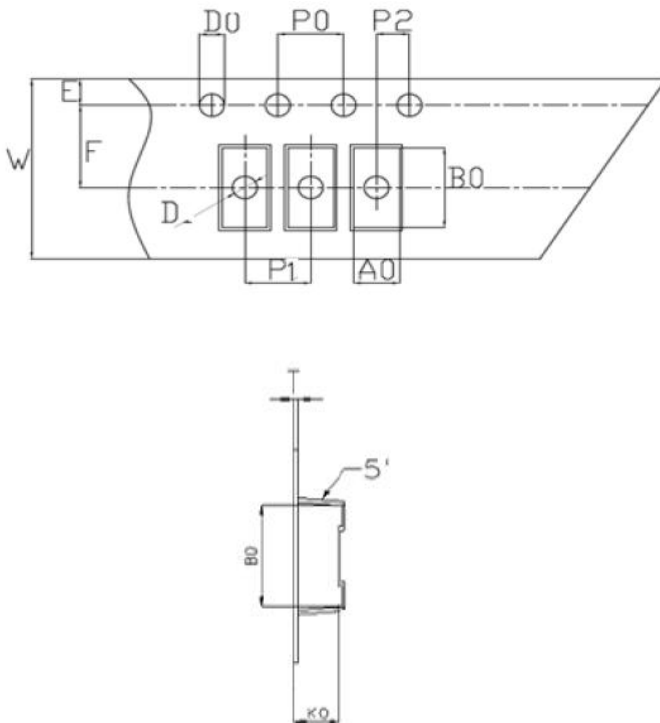

SYMBOL	Millimeters	
	Min.	Max.
A0	5.21	5.41
B0	7.10	7.30
D0	1.50	1.60
D1	1.40	1.60
P0	3.90	4.10
P1	7.90	8.10
P2	1.95	2.05
E	1.65	1.85
K0	1.55	1.75
F	5.45	5.55
W	11.90	12.10
T	0.24	0.30
10P0	39.80	40.20

**DISCLAIMER:**

1- The information given herein, including the specifications and dimensions, is subject to change without prior notice to improve product characteristics. Before ordering, purchasers are advised to contact the SMC Diode Solutions sales department for the latest version of the datasheet(s).

2- In cases where extremely high reliability is required (such as use in nuclear power control, aerospace and aviation, traffic equipment, medical equipment, and safety equipment), safety should be ensured by using semiconductor devices that feature assured safety or by means of users' fail-safe precautions or other arrangement.

3- In no event shall SMC Diode Solutions be liable for any damages that may result from an accident or any other cause during operation of the user's units according to the datasheet(s). SMC Diode Solution assumes no responsibility for any intellectual property claims or any other problems that may result from applications of information, products or circuits described in the datasheets.

4- In no event shall SMC Diode Solutions be liable for any failure in a semiconductor device or any secondary damage resulting from use at a value exceeding the absolute maximum rating.

5- No license is granted by the datasheet(s) under any patents or other rights of any third party or SMC Diode Solutions.

6- The datasheet(s) may not be reproduced or duplicated, in any form, in whole or part, without the expressed written permission of SMC Diode Solutions.

7- The products (technologies) described in the datasheet(s) are not to be provided to any party whose purpose in their application will hinder maintenance of international peace and safety nor are they to be applied to that purpose by their direct purchasers or any third party. When exporting these products (technologies), the necessary procedures are to be taken in accordance with related laws and regulations..