



# ACE4101

## Max. 1.6A Li-ion Switching Charger IC

### Description

The ACE4101 is a 1.6A Li-Ion battery switching charger intended for 5V adapters. Low power dissipation, an internal MOSFET and its compact package with minimum external components requirement makes the ACE4101 ideal for portable applications. The ACE4101 includes complete charge termination circuitry, automatic recharge and a  $\pm 1\%$  4.2V/4.35V float voltage.

External sense resistor and Reverse diode is not need. Build-in thermal feedback mechanism regulates the charge current to control the die temperature during high power operation or at elevated ambient temperature.

Battery charge current, charge timeout and end-of-charge indication parameters can program by external components. Additional features include shorted cell detection and overvoltage protection.

### Features

- Very Low Power Dissipation
- 1.6A Maximum Charge Current
- Standalone Capability with no Requirement of External MOSFET, Sense Resistor or Blocking Diode
- Constant-Current/Constant-Voltage Operation with Thermal Regulation to Maximize Charge Rate Without Risk of Overheating
- Charges Single Cell Li-Ion Batteries Directly from USB Port
- Drainage Charge Current Thermal Regulation Status Outputs for LED or System Interface
- Preset 4.2V/4.35V float Voltage with  $\pm 1\%$  Accuracy
- Automatic Recharge

### Application

- Cellular Telephones, PDA, MP3 Players
- Charging Docks and Cradles
- Handheld Battery-Powered Devices
- Handheld Computers

### Typical Application

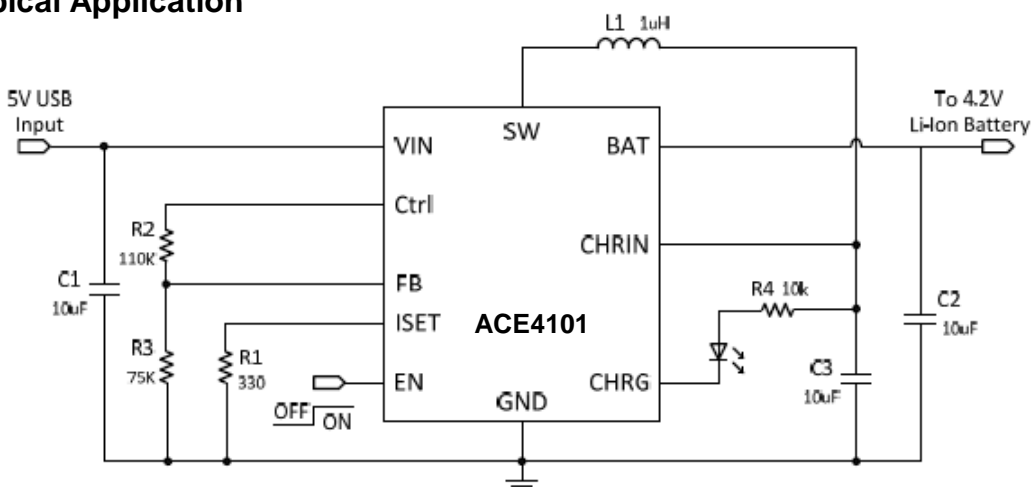

Device parameter should be select as typical application



# ACE4101

Max. 1.6A Li-ion Switching Charger IC

## Absolute Maximum Ratings

Parameter	Symbol	Max	Unit
Input voltage	$V_{IN}$	6.5	V
Operating Junction Temperature	$T_J$	125	$^{\circ}C$
Ambient Temperature	$T_A$	-40 ~ 85	$^{\circ}C$
Storage temperature	$T_S$	- 55 ~ 150	$^{\circ}C$
ESD (HBM)		>2000	V

Note: Exceed these limits to damage to the device. Exposure to absolute maximum rating conditions may affect device reliability.

## Packaging Type

DFN3\*3-10

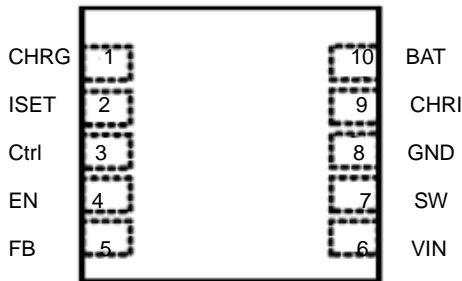

DFN3*3-10	Description	Function
1	CHRG	Open-Drain Charge Status Output. When the battery is charging, the CHRG pin is pulled low by an internal N-channel MOSFET. When the charge cycle is completed, hen the ACE4101 detects an under voltage lockout condition, CHRG is forced high impedance
2	ISET	Charge Current Program, Monitor the charge current and Shutdown. This pin set to 1V in constant-current mode. The charge current is programmed by connecting a 1% resistor, RISET, to GND pin
3	Ctrl	Sense Feedback Voltage Pin
4	EN	Enable Input Pin. Pulling the EN pin high places the ACE4101 into a low power state where the BAT drain current drops to less than 3 $\mu$ A and the supply current is reduced to less than 50 $\mu$ A. For normal operation, pull the pin low
5	FB	Battery Feedback Voltage
6	VIIN	Positive Supply Voltage Input. This pin connects to the power devices inside the chip. VIN ranges from 4V to 5.5V for normal operation. Operation down to the under-voltage lockout threshold is allowed with current limited wall adapters. Decouple with a 10 $\mu$ F or larger surface mounted ceramic capacitor
7	SE	Switch Node Connection. This pin connects to the drains of the internal main and synchronous power MOSFET switches. Connect to external inductor
8	GND	Ground
9	CHRIN	Power Path Output Voltage
10	BAT	Battery Charger Output Terminal. Connect a 22 $\mu$ F ceramic chip capacitor between BAT and PGND to keep the ripple voltage small



# ACE4101

Max. 1.6A Li-ion Switching Charger IC

## Ordering information

ACE4101 XX XX + H

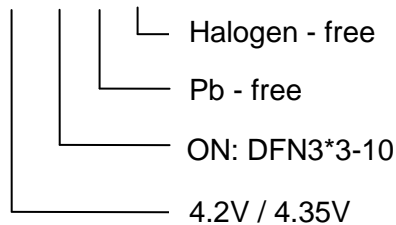

## Recommended Work Conditions

Item	Min	Max	Unit
Input Voltage Range		6	V
Operating Junction Temperature (T <sub>J</sub> )	-40	85	°C

## Electrical Characteristics (V<sub>DD</sub>=5V, T<sub>A</sub>=25°C)

Parameter	Symbol	Conditions	Min	Typ	Max	Units
Adapter/USB Voltage Range	V <sub>IN</sub>		2.6		6	V
Input Supply Current	I <sub>CC</sub>	Charge Mode, R <sub>ISET</sub> =10k, Standby Mode (Charge Terminated) (Note)		300	2000	uA
		Shutdown Mode (R <sub>ISET</sub> Not Connected)		200	500	
		V <sub>CC</sub> <V <sub>BAT</sub> , or V <sub>CC</sub> <V <sub>UV</sub> )		30	50	
Regulated Output (Float) Voltage	V <sub>FLOAT</sub>	0°C ≤ T <sub>A</sub> ≤ 85°C, I <sub>BAT</sub> =40mA	4.158	4.2	4.242	V
			4.3065	4.35	4.3935	
BAT Pin Current	I <sub>BAT</sub>	R <sub>ISET</sub> =10k, Current Mode	85	100	115	mA
		R <sub>ISET</sub> =0.33k, Current Mode	1.35	1.5	1.65	A
		Standby Mode, V <sub>BAT</sub> =4.2V Shutdown Mode (R <sub>ISET</sub> Not Connected) Sleep Mode, V <sub>CC</sub> =0V	0	-2.5	-6	uA
		1	5			
Trickle Charge Current	I <sub>THIKL</sub>	V <sub>BAT</sub> <V <sub>TRIKL</sub> , R <sub>ISET</sub> =2k	20	45	70	mA
Trickle Charge Threshold Voltage	V <sub>TRIKL</sub>	R <sub>ISET</sub> =10k, V <sub>BAT</sub> Rising	2.8	2.9	3	V
Trickle Charge Hysteresis Voltage	V <sub>TRHYS</sub>	R <sub>ISET</sub> =10k	60	85	110	mV
ISET Pin Voltage	V <sub>ISET</sub>	R <sub>ISET</sub> =10k, Current Mode	0.93	1	1.07	V
CHRG Pin Output Low Voltage	V <sub>CHRG</sub>	I <sub>CHRG</sub> =5mA		0.315	0.6	V
Recharge Battery Threshold Voltage	ΔV <sub>RECHRG</sub>	V <sub>FLOAT</sub> -V <sub>RECHRG</sub>	100	160	200	mV



# ACE4101

## Max. 1.6A Li-ion Switching Charger IC

Note : Supply current includes ISET pin current (approximately 100 $\mu$ A) but does not include any current delivered to the battery through the BAT pin (approximately 100mA).

### Block Diagram

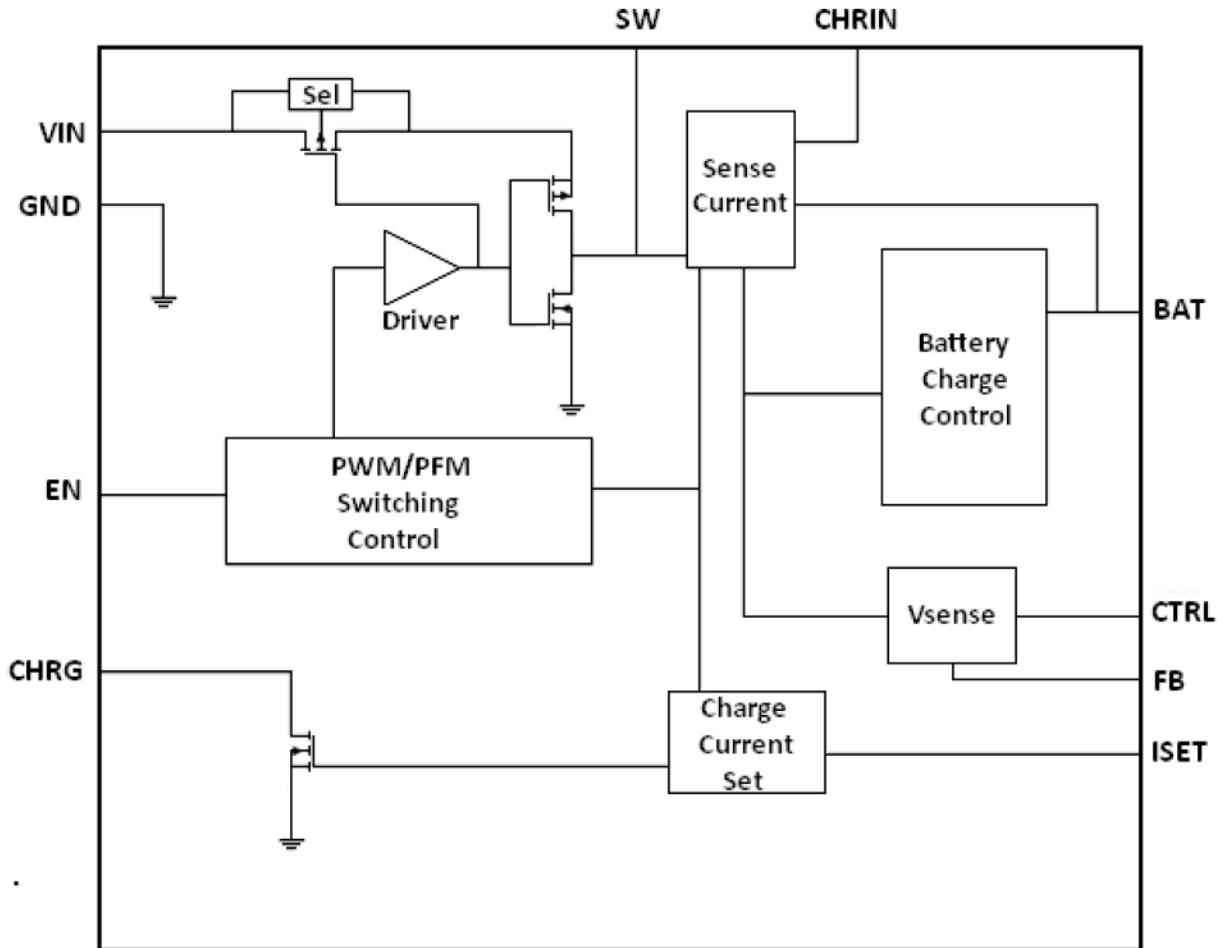

### Electrical Performance (Tested under $T_A=25^{\circ}\text{C}$ , unless otherwise specified)

IBAT vs. VBAT

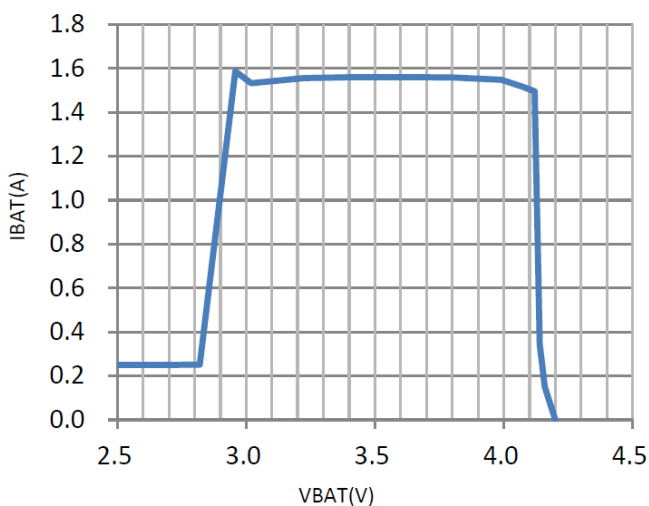

Efficiency vs. VBAT

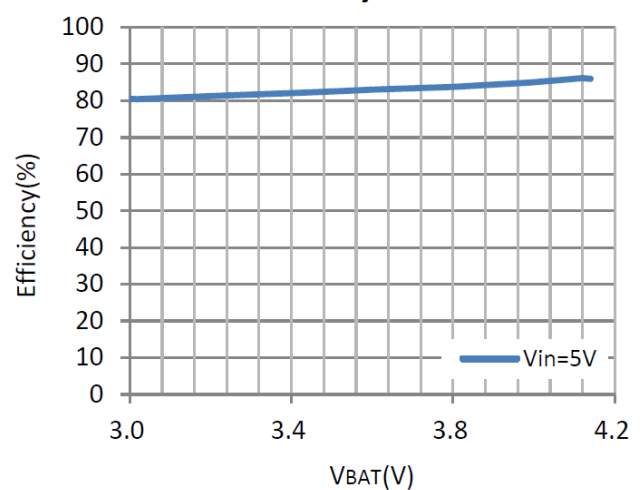



# ACE4101

## Max. 1.6A Li-ion Switching Charger IC

**Electrical Performance** (Tested under  $T_A=25^\circ\text{C}$ , unless otherwise specified)

**IBAT vs. RISET**

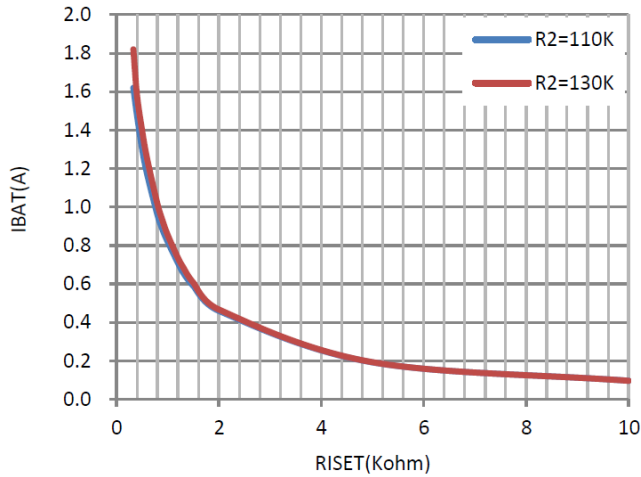

**ISET Pin Pull-up Current vs. Temperature and VIN**

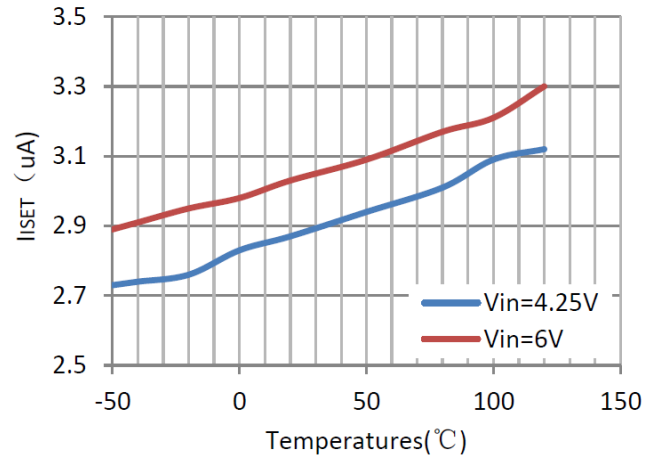

**Regulated Output (Float) Voltage vs. Temperature**

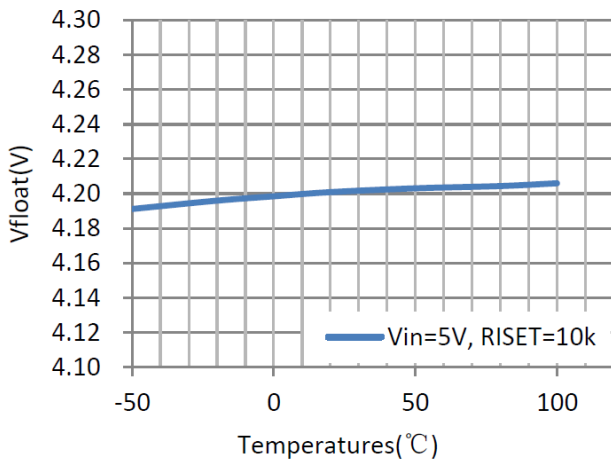

**CHRG pin Current vs. Temperature (strong Pull-down State)**

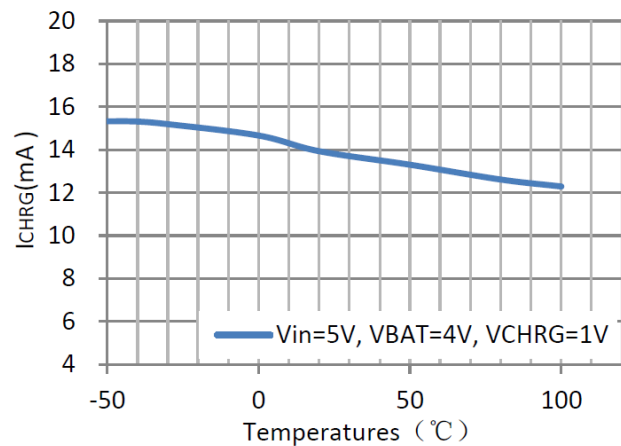

**CHRG Current vs. Temperature**

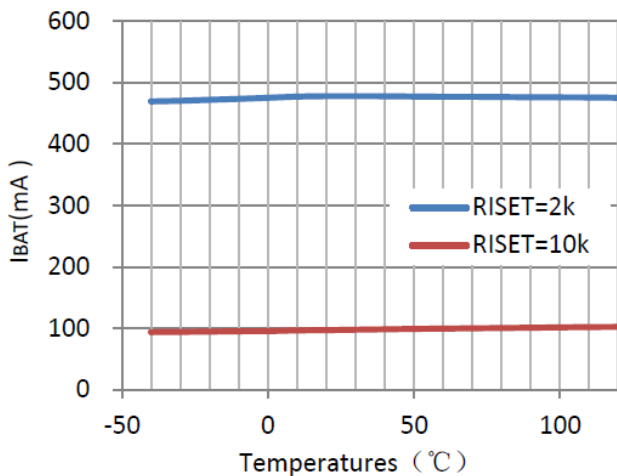

**VISET vs. Temperature**

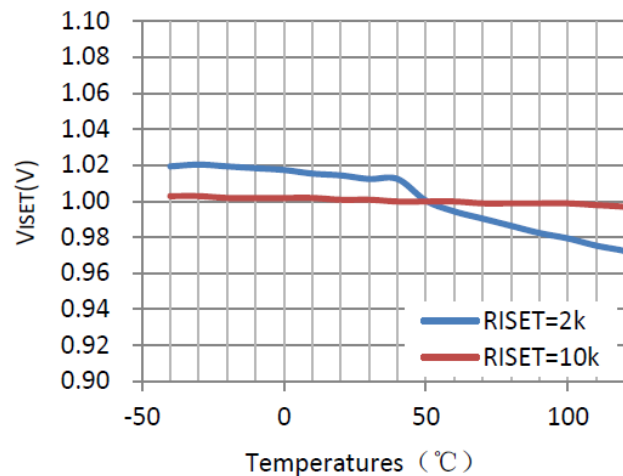



# ACE4101

## Max. 1.6A Li-ion Switching Charger IC

### Detailed Description

#### General description

The ACE4101 is a constant current, constant voltage Li-Ion battery switching charger controller. The charge current is set by an external sense resistor (R<sub>ISET</sub>) across the ISET and GND pins. The final battery float voltage is internally set to 4.2V/4.35V per cell. For batteries like lithium-ion that require accurate final float voltage, the internal reference, voltage amplifier and the resistor divider provide regulation with ±1% accuracy.

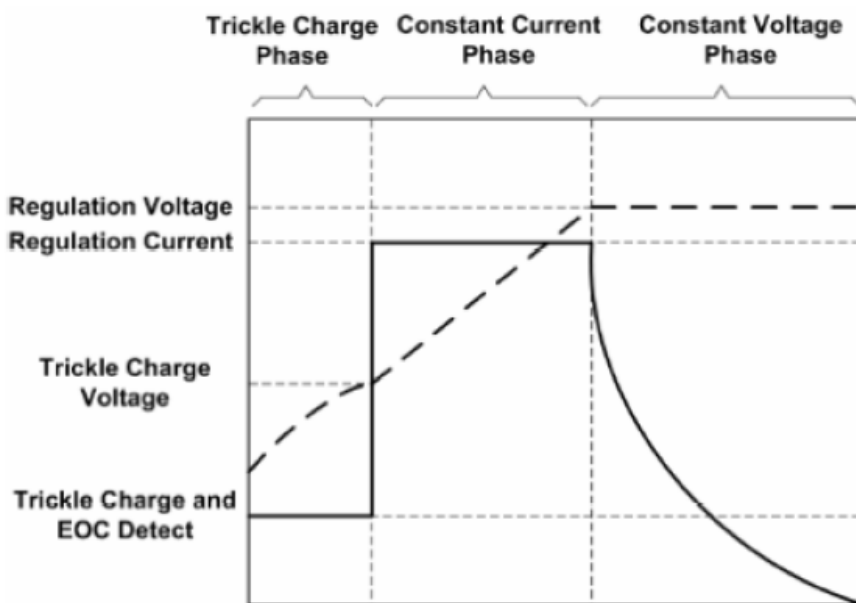

A charge cycle begins when the voltage at the VCC pin rises above the UVLO level and is 250mV or more greater than the battery voltage. At the beginning of the charge cycle, if the battery voltage is less than the trickle charge threshold, 2.9V for the 4.2 version, the charger goes into trickle charge mode. The trickle charge current is internally set to 10% of the full-scale current. The charge current is programmable by setting the value of a precision resistor connected from the ISET pin to ground. The charge current is 1000 times of the current out of the ISET pin. The program resistor and the charge current are calculated using the following equations:

$$R_{ISET} \approx \frac{1000V}{I_{BAT}}$$

The charge current out of the BAT pin can be determined at any time by monitoring the ISET pin voltage using the following equation:

$$I_{BAT} \approx \frac{V_{ISET}}{R_{ISET}} \cdot 1000$$



# ACE4101

## Max. 1.6A Li-ion Switching Charger IC

When the battery voltage approaches the programmed float voltage, the charge current will start to decrease. It terminates the charge cycle when the charge current falls to 10% of the full-scale value after the final float voltage is reached. When the ISET pin voltage falls below 100mV for longer than tTERM (typically 1ms), charging is terminated. The charge current is latched off and the ACE4101 enters standby mode, where the input supply current drops to 200µA. (Note: C/10 termination is disabled in trickle charging and thermal limiting modes).

### Manual Shutdown

Floating the ISET pin by removing the resistor from ISET pin to ground can put the device in shutdown mode. The battery drain current is thus reduced to less than 5µA and the supply current to less than 50µA. Reconnecting the resistor back will restart a new charge cycle.

Once manually shutdown, the CHRГ pin is in a weak pull-down state if VIN is above UVLO voltage. The CHRГ pin is in a high impedance state if the ACE4101 is in under voltage lockout mode.

### Automatic Recharge

After the termination of the charge cycle, the ACE4101 constantly monitors the BAT pin voltage and starts a new charge cycle when the battery voltage falls below 4.05V, keeping the battery at fully charged condition. CHRГ output enters a strong pull-down state during recharge cycles.

### Inductor Selection

The peak-to-peak ripple is limited to 30% of the maximum output current. This places the peak current far enough from the minimum over current trip level to ensure reliable operation while providing enough current ripples for the current mode converter to operate stably. In this case, for 1.6A maximum output current, the maximum inductor ripple current is 667 mA. The inductor size is estimated as following equation:

$$I_{IDEAL} = \frac{(V_{IN(MAX)} - V_{BAT}) \cdot D_{MIN}}{I_{RIPPLE} \cdot F_{OSC}}$$

### Layout Considerations

C<sub>IN</sub> must be close to Pins VIN and GND, the loop area formed by C<sub>IN</sub> and GND must be minimized. Place C<sub>CHRIN</sub> as close to Pins CHRIN and GND. The PCB copper area associated with SW pin must be minimized to avoid the potential noise problem. FB Resistors and the traces connecting to the FB pin must not adjacent to the SW net on the PCB layout to avoid the noise problem. ISET resistor must be as far away with the SW net as possible. The thermal pad under the IC must be tied to the ground area on the top layer, and use via to connect this ground area to any internal ground planes.



# ACE4101

Max. 1.6A Li-ion Switching Charger IC

## Packing Information

DFN3\*3-10

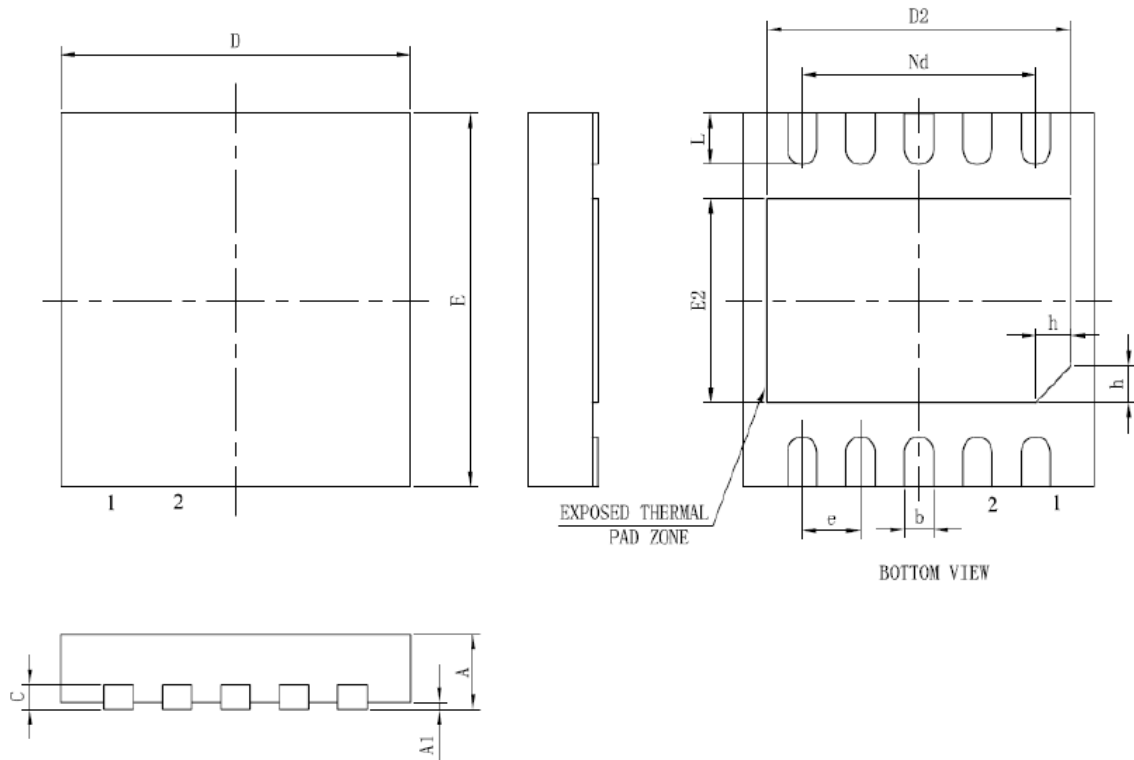

Symbol	Dimensions in millimeters		
	Min.	Nom.	Max.
A	0.70	0.75	0.80
A1	-	0.02	0.05
b	0.18	0.25	0.30
c	0.18	0.20	0.25
D	2.90	3.00	3.10
D2	2.4	2.50	2.60
e	0.50BSC		
Nd	2.00BSC		
E	2.90	3.00	3.10
E2	1.45	1.55	1.65
L	0.30	0.40	0.50
h	0.20	0.25	0.30
L/F (mil)	106*75		





# ACE4101

Max. 1.6A Li-ion Switching Charger IC

## Notes

ACE does not assume any responsibility for use as critical components in life support devices or systems without the express written approval of the president and general counsel of ACE Electronics Co., LTD. As sued herein:

1. Life support devices or systems are devices or systems which, (a) are intended for surgical implant into the body, or (b) support or sustain life, and whose failure to perform when properly used in accordance with instructions for use provided in the labeling, can be reasonably expected to result in a significant injury to the user.
2. A critical component is any component of a life support device or system whose failure to perform can be reasonably expected to cause the failure of the life support device or system, or to affect its safety or effectiveness.

ACE Technology Co., LTD.  
<http://www.ace-ele.com/>