

## Data Sheet

### Description

The Avago Technologies' ACFM-7102 is a quintplexer that combines PCS and Cellular duplexer functions with a GPS filter. This device simplifies handset applications that are designed for simultaneous voice service and GPS positioning.

The ACFM-7102 is designed with Avago Technologies' Film Bulk Acoustic Resonator (FBAR) technology. The ACFM-7102 also utilizes Avago Technologies' innovative Microcapbonded-wafer, chipscale packaging technology. This process allows the filters to be assembled in a module that is less than 1.2 mm high with a footprint of only 5 mm x 8 mm.

Low Tx Insertion Loss reduces power amplifier current, extending battery life and talk time. The ACFM-7102 enhances receiver sensitivity and dynamic range with low Rx Insertion Loss and high rejection of Tx signals at the Rx ports.

The excellent power handling capability of Avago Technologies' FBAR bulk-mode resonators supports the high Tx output power levels needed in handsets while adding virtually no distortion.

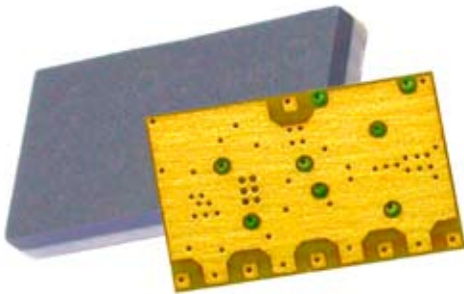

### Functional Block Diagram

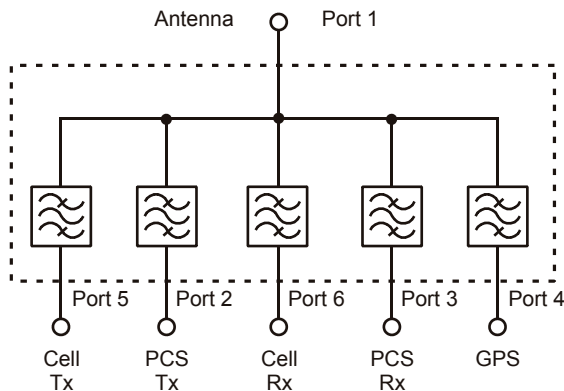

### Features

- Single Antenna connection for PCS duplexer, Cellular duplexer, and GPS filter
- Miniature size
  - 5 x 8 mm footprint
  - 1.2 mm Max height
- High Power Rating
  - +33 dBm Max Tx Power
- Lead-Free Construction

### Specifications

- Performance guaranteed –30 to +85°C
- GPS Filter (1574.4–1576.4 MHz)
  - Insertion Loss: 2.0 dB Max
  - Isolation in PCS/Cell Tx: 45 dB Min
- Cellular Duplexer Rx (869 – 894 MHz)
  - Insertion Loss: 3.6 dB Max
  - Noise Blocking: 40 dB Min
- Cellular Duplexer Tx (824 – 849 MHz)
  - Insertion Loss: 2.6 dB Max
  - Interferer Blocking: 55 dB Min
- PCS Duplexer Rx (1930.5 – 1989.5 MHz)
  - Insertion Loss: 4.4 dB Max
  - Noise Blocking: 40 dB Min
- PCS Duplexer Tx (1850.5 – 1909.5 MHz)
  - Insertion Loss: 3.9 dB Max
  - Interferer Blocking: 53 dB Min

### Applications

- Handsets or data terminals operating in the PCS and Cellular frequency bands with simultaneous GPS positioning capability

**ACFM-7102 Electrical Specifications,  $Z_0=50\Omega$ ,  $T_C^{[1][2]}$  as indicated**

Symbol	Parameter	Unit	-30°C			+25°C			+85°C		
			Min	Typ <sup>[3]</sup>	Max	Min	Typ <sup>[3]</sup>	Max	Min	Typ <sup>[3]</sup>	Max
<b>GPS Filter Performance</b>											
<b>Antenna Port to GPS Receive Port</b>											
S41	Insertion Loss in GPS Band (L1) (1574.4–1576.4 MHz)	dB			1.9		1.0	1.9			2.0
S41	Insertion Loss Ripple (p-p) in GPS Band	dB			1.0		0.7	1.0			1.0
S44	Return Loss of GPS Port in GPS Band	dB	9			9	26			9	
S11	Return Loss of Antenna Port in GPS Band	dB	9			9	19			9	
<b>Isolation-Cellular Transmit Port to GPS Port</b>											
S45	Isolation in Cellular Tx Band (824–849 MHz)	dB	50			50	55			50	
S45	Isolation in GPS Band (1574.4–1576.4 MHz)	dB	38			38	42			38	
<b>Isolation-PCS Transmit Port to GPS Port</b>											
S42	Isolation in PCS Tx Band (1850.5 – 1909.5 MHz)	dB	45			45	55			45	
S42	Isolation in GPS Band (1574.4–1576.4 MHz)	dB	40			40	48			40	
<b>Cellular Duplexer Performance</b>											
<b>Antenna Port to Cellular Receive Port</b>											
S61	Insertion Loss in Rx band (869–894 MHz)	dB			3.6		1.8	3.4			3.6
S61	Insertion Loss Ripple (p-p) in Rx Band	dB			1.8		1.2	1.8			1.8
S61	Attenuation in Tx band (824–849 MHz)	dB	55			55	64			50	
S61	Attenuation 0–804 MHz	dB	25			25	36			25	
S61	Attenuation in Tx 2nd harmonic band (1648–1698 MHz)	dB	30			30	64			30	
S61	Attenuation in Tx 3rd harmonic band (2472–2547 MHz)	dB	19			19	42			19	
S66	Return Loss of Rx Port in Rx Band (869–894 MHz)	dB	9			9	16			9	
S11	Return Loss of Antenna Port in Rx Band (869–894 MHz)	dB	9	12		9	13			9	12
<b>Cellular Transmit Port to Antenna Port</b>											
S15	Insertion Loss in Tx band (824–849 MHz)	dB			2.6		1.4	2.6			2.6
S15	Insertion Loss Ripple (p-p) in Tx Band	dB			1.6		1.4	1.6			1.6
S15	Attenuation in Rx band (869–894 MHz)	dB	39			40	50			37	
S15	Attenuation, 0–804 MHz	dB	20			20	38			20	
S15	Attenuation in GPS band (1574.4–1576.4 MHz)	dB	37			37	41			37	
S15	Attenuation in Tx 2nd harmonic band (1648–1698 MHz)	dB	15			15	29			15	
S15	Attenuation in Tx 3rd harmonic band (2472–2547 MHz)	dB	8			8	17			8	
S55	Return Loss of Tx Port in Tx band (824–849 MHz)	dB	9			9	15			9	
S11	Return Loss of Antenna port in Tx Band (824–849 MHz)	dB	9	12		9	16			9	12
<b>Isolation, Cellular Transmit Port to Cellular Receive Port</b>											
S65	Isolation, Tx to Rx port in Rx Band (869–894 MHz)	dB	40			40	52			40	
S65	Isolation, Tx to Rx port in Tx Band (824–849 MHz)	dB	55			55	68			55	

**ACFM-7102 Electrical Specifications,  $Z_0=50\Omega$ ,  $T_C^{[1][2]}$  as indicated (cont)**

Symbol	Parameter	Unit	-30°C			+25°C			+85°C		
			Min	Typ <sup>[3]</sup>	Max	Min	Typ <sup>[3]</sup>	Max	Min	Typ <sup>[3]</sup>	Max
<b>PCS Duplexer Performance</b>											
<b>Antenna Port to PCS Receive Port</b>											
S31	Insertion Loss in Rx Band (1930.5–1989.5 MHz)	dB			4.4		2.0	4.2			4.4
S31	Insertion Loss Ripple (p-p) in Rx Band	dB			3.0		1.9	3.0			3.0
S31	Attenuation in Tx Band (1850.5–1909.5 MHz)	dB	50			50	59			50	
S31	Attenuation 0.03–1770 MHz	dB	20			20	43			20	
S31	Attenuation 2020–3700 MHz	dB	30			30	53			30	
S31	Attenuation 3820–4000 MHz	dB	30			30	38			30	
S33	Return Loss of Rx Port in Rx Band (1930.5–1989.5 MHz)	dB	9			9	17			9	
S11	Return Loss of Antenna Port in Rx Band (1930.5–1989.5 MHz)	dB	9	12		9	17			9	12
<b>PCS Transmit Port to Antenna Port</b>											
S12	Insertion Loss in Tx Band (1850.5–1909.5 MHz)	dB			3.9		1.8	3.9			3.9
S12	Insertion Loss Ripple (p-p) in Tx Band	dB			2.8		1.3	2.8			2.8
S12	Attenuation in Rx Band (1930.5–1989.5 MHz)	dB	40			40	50			40	
S12	Attenuation 0.03–1570 MHz	dB	20			20	44			20	
S12	Attenuation in GPS Band (1574.4–1576.4 MHz)	dB	37			37	42			37	
S12	Attenuation 1580 – 1700 MHz	dB	25			25	44			25	
S12	Attenuation in Tx 2nd harmonic band (3701–3819 MHz)	dB	10			10	23			10	
S12	Attenuation in Tx 3rd harmonic band (5551.5–5728.5 MHz)	dB	8			8	22			8	
S22	Return Loss of Tx Port in Tx band (1850.5–1909.5 MHz)	dB	9.5			9.5	16			9.5	
S11	Return Loss of Antenna port in Tx Band (1850.5–1909.5 MHz)	dB	9	12		9	17			9	12
<b>Isolation, PCS Transmit Port to PCS Receive Port</b>											
S32	Isolation, Tx to Rx port in Rx Band (1930.5–1909.5 MHz)	dB	40			40	47			40	
S32	Isolation, Tx to Rx port in Tx Band (1850.5–1855 MHz)	dB	53			53	62			53	
	(1855–1909.5 MHz)		54			54	60			54	

Notes:

- 1)  $T_C$  is the case temperature and is defined as the temperature of the underside of the quintplexer where it makes contact with the circuit board.
- 2) Min/Max specifications are guaranteed at the indicated temperature with the input power to the Tx ports equal to or less than +29 dBm over all Tx frequencies unless otherwise noted.
- 3) Typical data is the arithmetic mean value of the parameter over its indicated frequency range at the specified temperature. Typical values may vary over time.

## Absolute Maximum Ratings<sup>[1]</sup>

Parameter	Unit	Value
Storage temperature	°C	-65 to +125
Maximum RF Input Power to Tx Ports	dBm	+33

## Maximum Recommended Operating Conditions<sup>[2]</sup>

Parameter	Unit	Value
Operating temperature, $T_c$ <sup>[3]</sup> , Tx Power $\leq$ 29 dBm	°C	-40 to +100
Operating temperature, $T_c$ <sup>[3]</sup> , Tx Power $\leq$ 30 dBm	°C	-40 to +85

Notes:

- 1) Operation in excess of any one of these conditions may result in permanent damage to the device.
- 2) The device will function over the recommended range without degradation in reliability or permanent change in performance, but is not guaranteed to meet electrical specifications.
- 3)  $T_c$  is defined as case temperature, the temperature of the underside of the quintplexer where it makes contact with the circuit board.

## Characterization

A test circuit similar to that shown in Figure 1 was used to measure device performance. This circuit is designed to interface with Air Coplanar (ACP), Ground-Signal-Ground (GSG) RF probes of the type commonly used to test semiconductor wafers.

The test circuit is a 17 x 14 mm PCB with a well-grounded pad to which the device under test (DUT) is solder-mounted.

Short lengths of 50-ohm microstripline connect the DUT to ACP probe patterns on the board.

A test circuit with an ACFM-7102 mounted in place is shown in Figure 2. S-parameters are measured using a vector network analyzer and calibrated ACP probe set.

Phase data for s-parameters measured with ACP probe circuits are adjusted to place the reference plane at the edge of the quintplexer package.

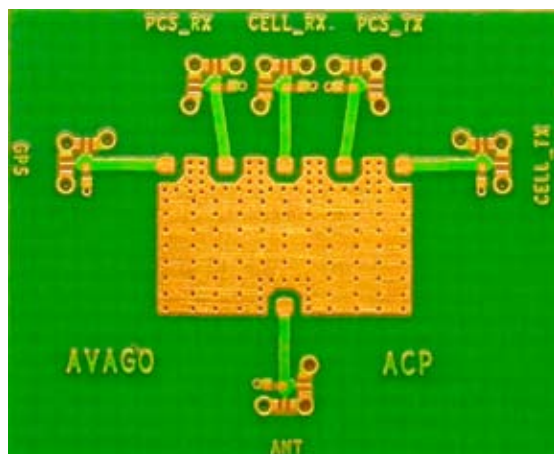

Figure 1. ACP Probe Test Circuit.

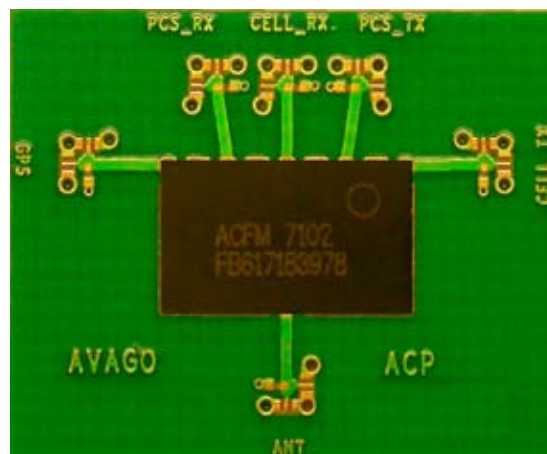
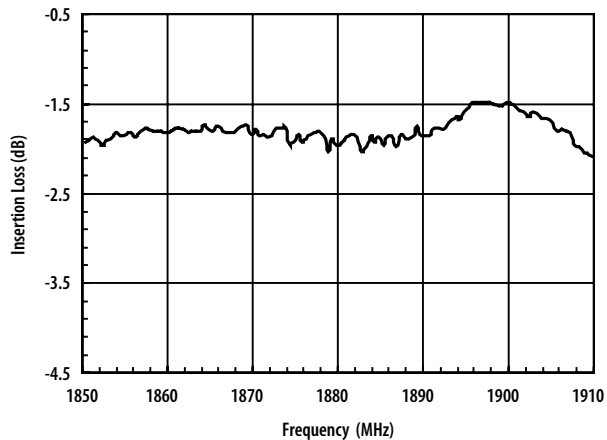
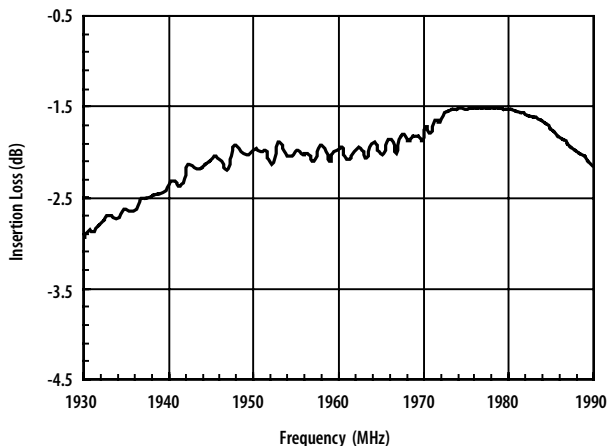

Figure 2. Test Circuit with ACFM-7102 Quintplexer.

**ACFM-7102 Typical Performance at  $T_C=25^\circ\text{C}$**



**Figure 3. PCS Tx Band Insertion Loss.**



**Figure 4. PCS Rx Band Insertion Loss.**

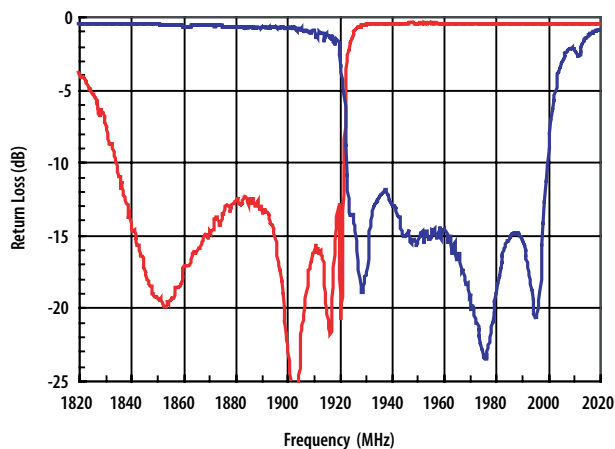

**Figure 5. PCS Tx and Rx Port Return Loss.**

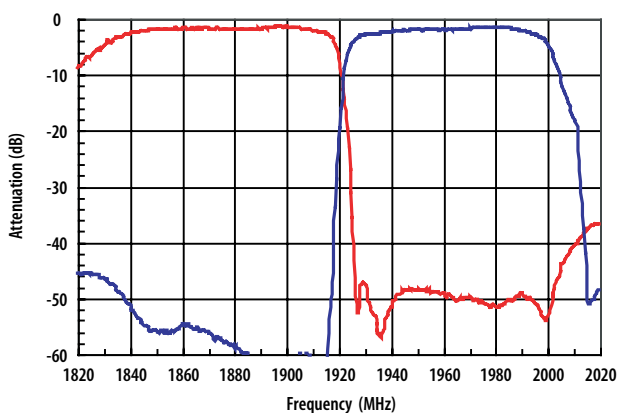

**Figure 6. PCS Tx Rejection in Rx Band and Rx Rejection in Tx Band.**

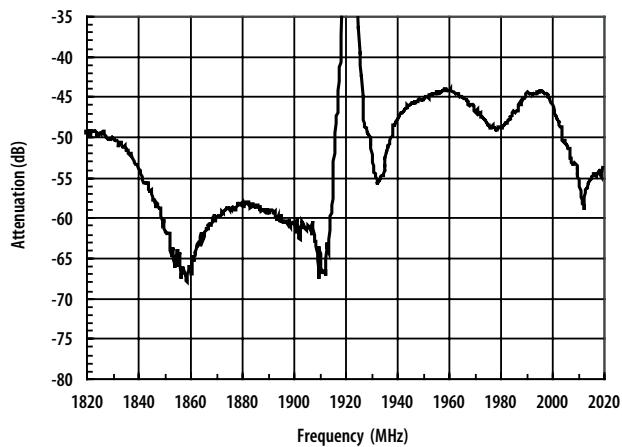

**Figure 7. PCS Tx-Rx Isolation.**

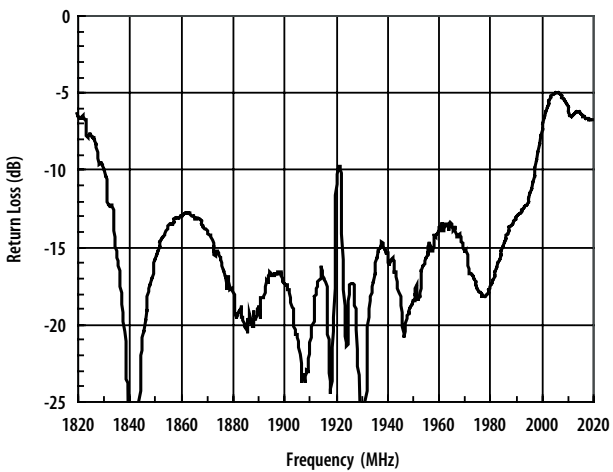

**Figure 8. PCS Antenna Port Return Loss.**

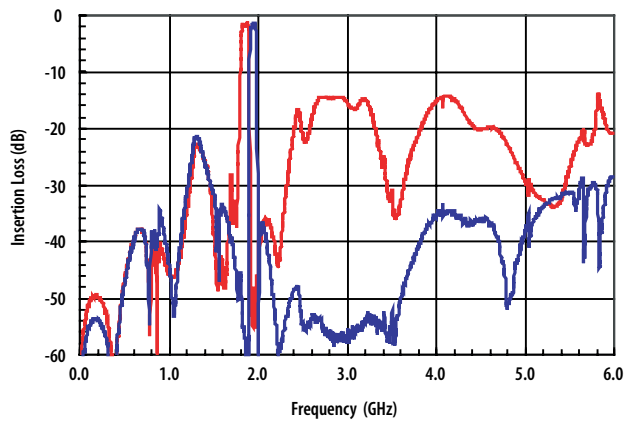

Figure 9. PCS Tx and Rx Wideband Insertion Loss.

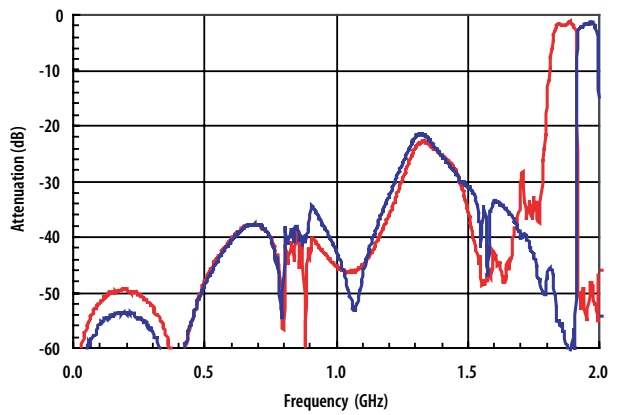

Figure 10. PCS Tx and Rx Low Frequency Rejection.

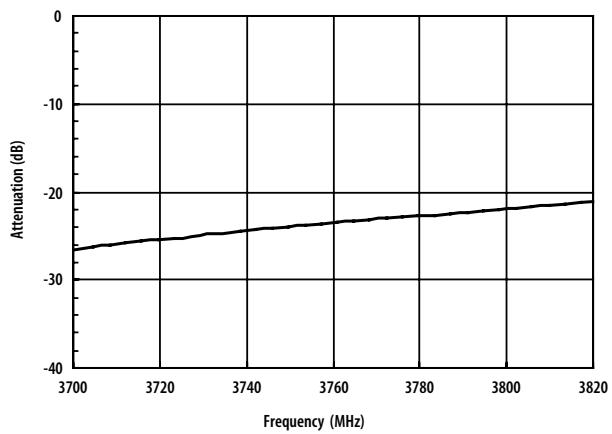

Figure 11. PCS Tx-Ant Rejection at Tx Second Harmonic.

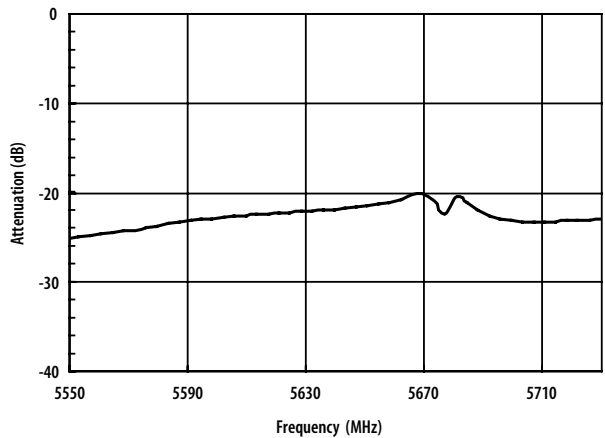

Figure 12. PCS Tx-Ant Rejection at Tx Third Harmonic.

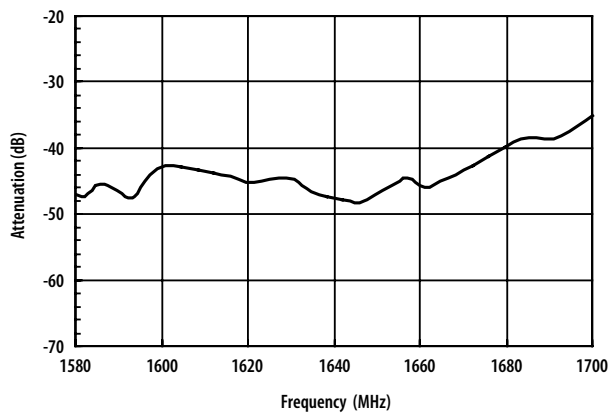

Figure 13. PCS Tx-Ant Rejection, 1580-1700 MHz.

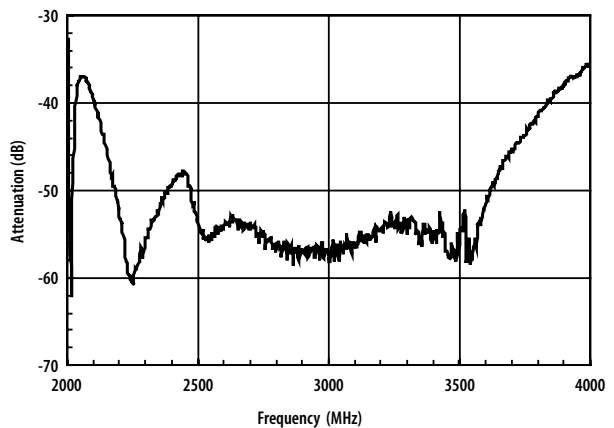

Figure 14. PCS Rx-Ant Rejection, 2000-4000 MHz.

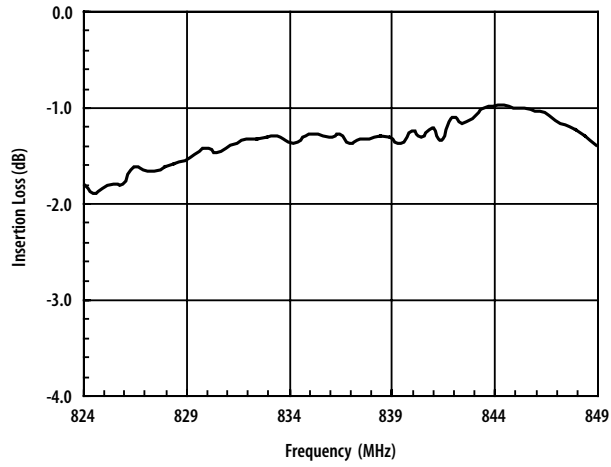

Figure 15. Cellular Tx Insertion Loss.

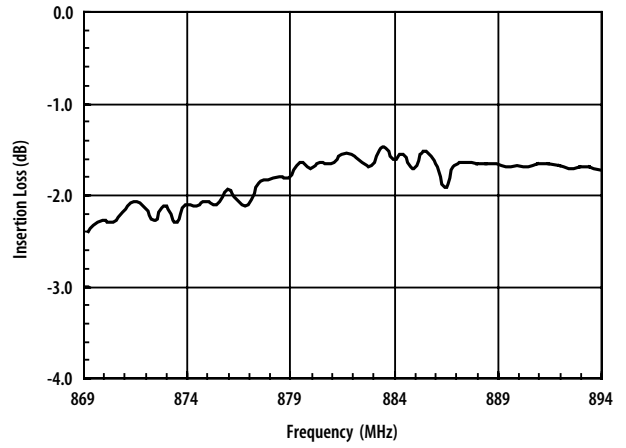

Figure 16. Cellular Rx Insertion Loss.

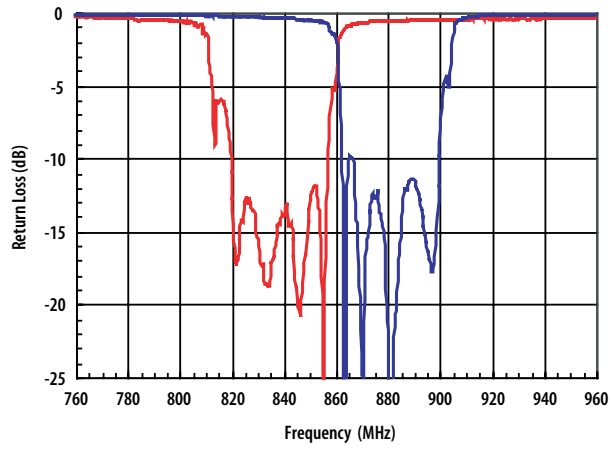

Figure 17. Cellular Tx and Rx Return Loss

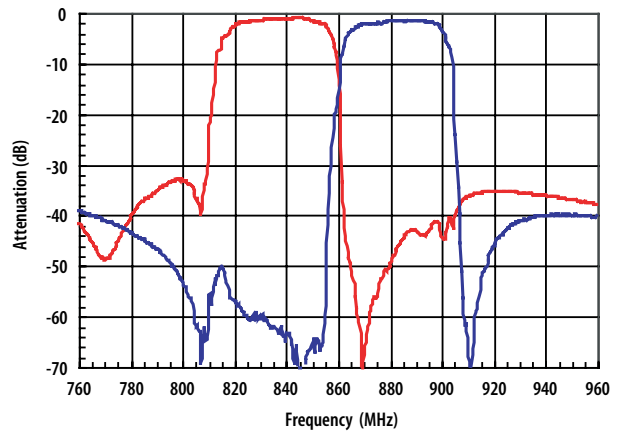

Figure 18. Cellular Tx Rejection in Rx Band and Rx Rejection in Tx Band.

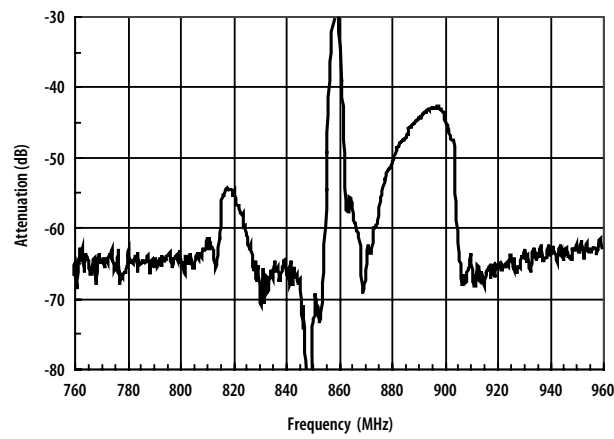

Figure 19. Cellular Tx-Rx Isolation.

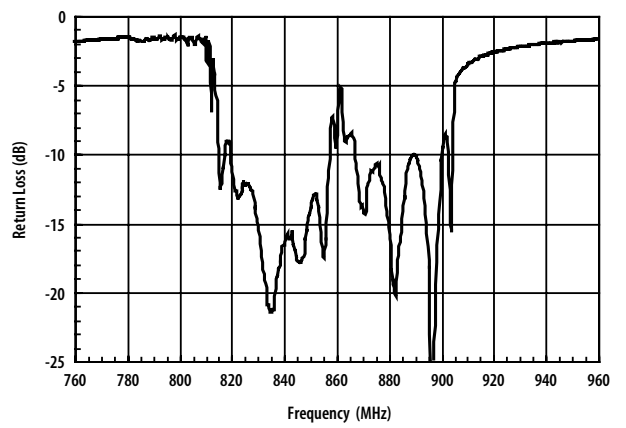

Figure 20. Cellular Band Antenna Return Loss.

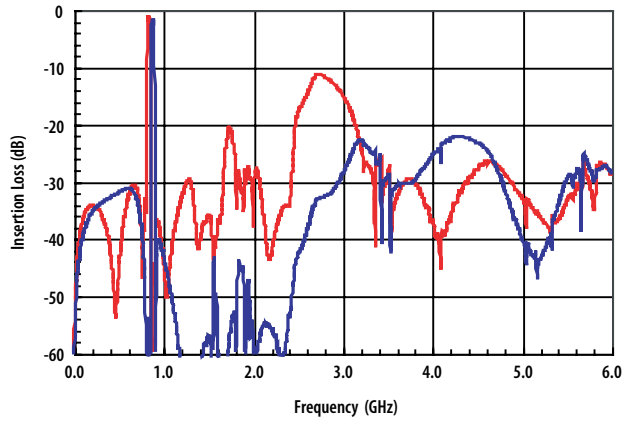

Figure 21. Cellular Tx-Ant and Rx-Ant Wideband Insertion Loss.

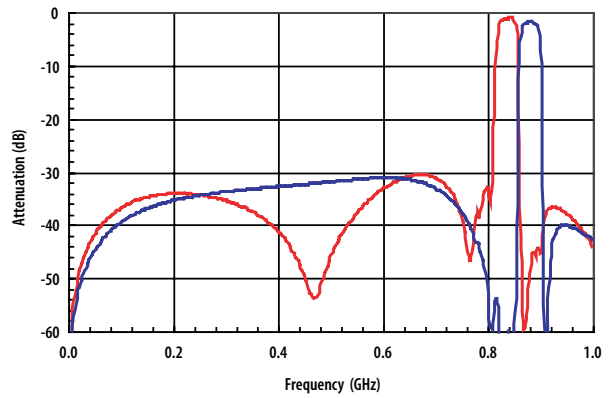

Figure 22. Cellular Tx-Ant and Rx-Ant Low Frequency Rejection.

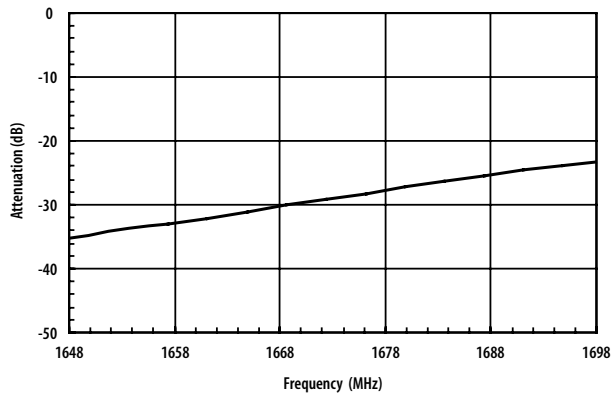

Figure 23. Cellular Tx-Ant Rejection at Tx Second Harmonic.

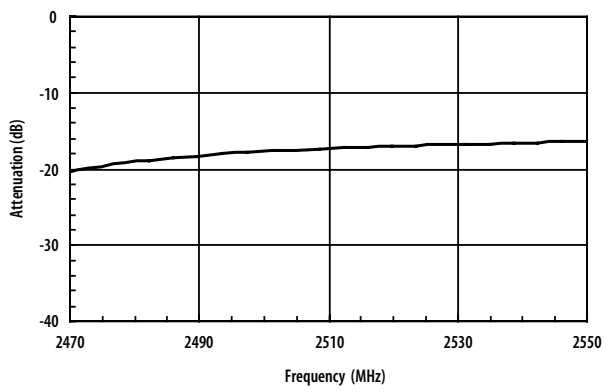

Figure 24. Cellular Tx-Ant Rejection at Tx Third Harmonic.

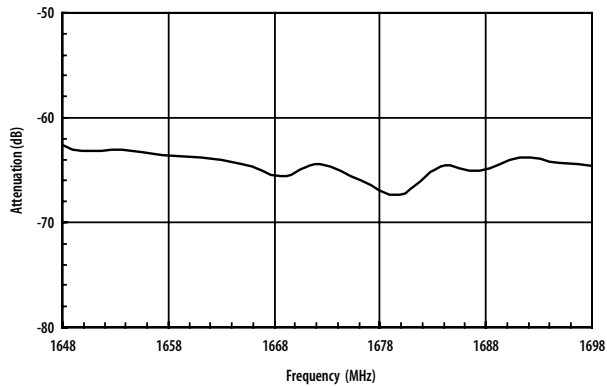

Figure 25. Cell Ant-Rx Rejection at Tx Second Harmonic.

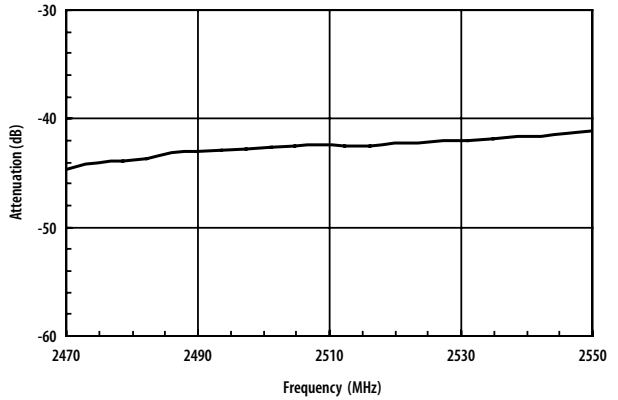

Figure 26. Cellular Ant-Rx Rejection at Tx Third Harmonic.



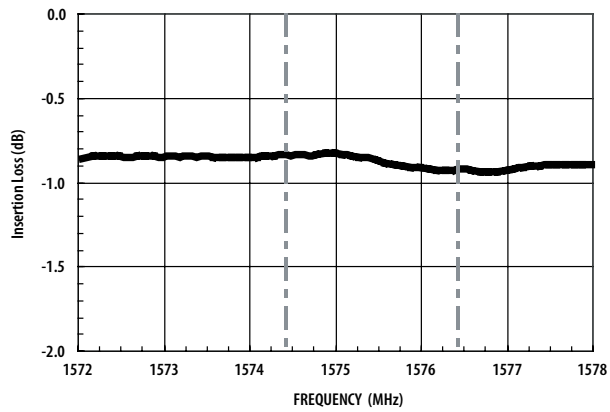

Figure 27. Ant-GPS Port Insertion Loss.

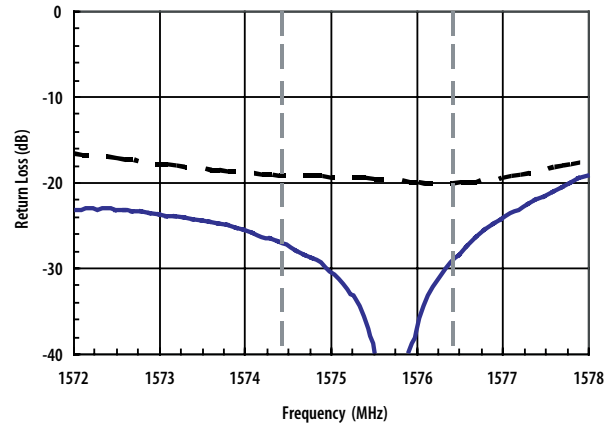

Figure 28. Return Loss, GPS Port (solid), Ant Port (dash).

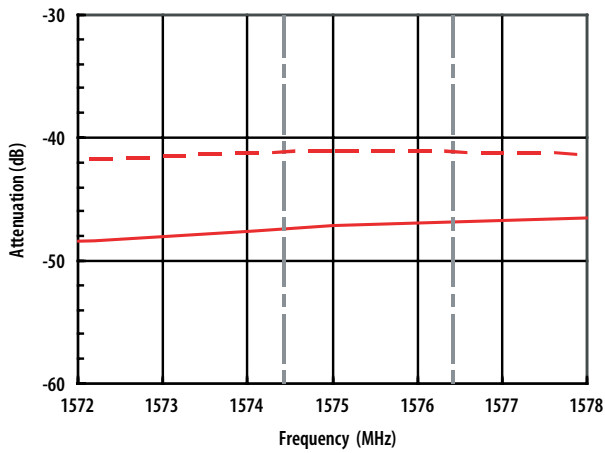

Figure 29. PCS Tx-Ant (solid) and Cell Tx-Ant (dash) Rejection in GPS Band.

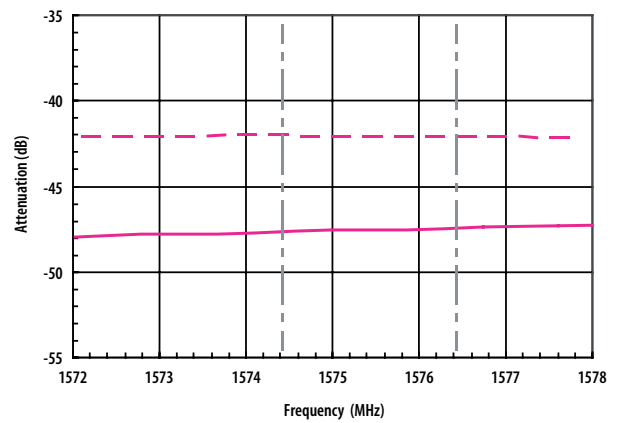

Figure 30. Isolation, PCS Tx (solid) and Cellular Tx (dash) Ports to GPS Port in GPS Band.

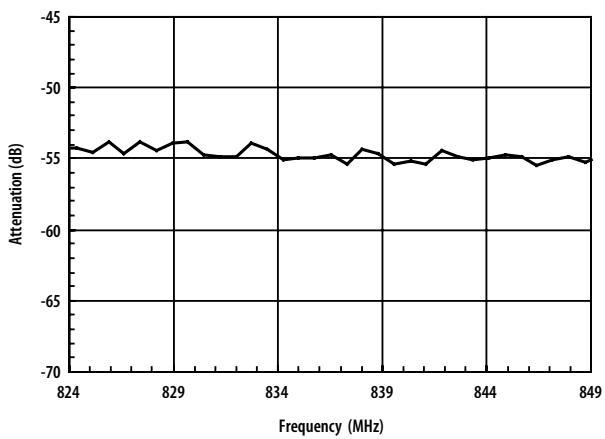

Figure 31. Isolation, Cellular Tx Port to GPS Port in Cellular Tx Band.

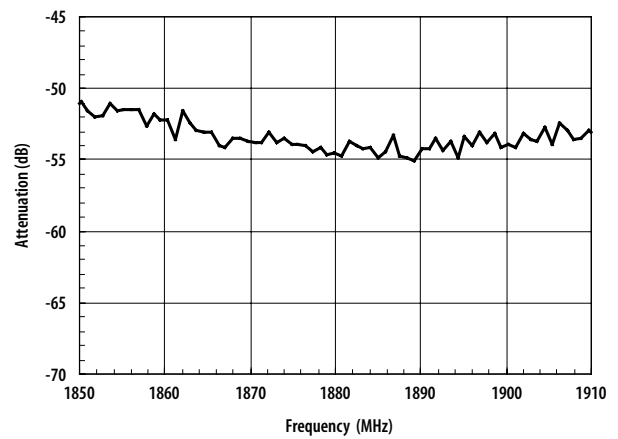

Figure 32. Isolation, PCS Tx Port to GPS Port in PCS Tx Band.

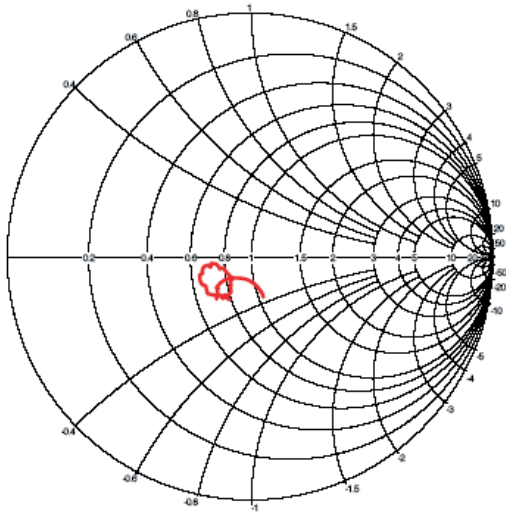

Figure 33. Cell Tx Impedance (S55) in Cell Tx Band.

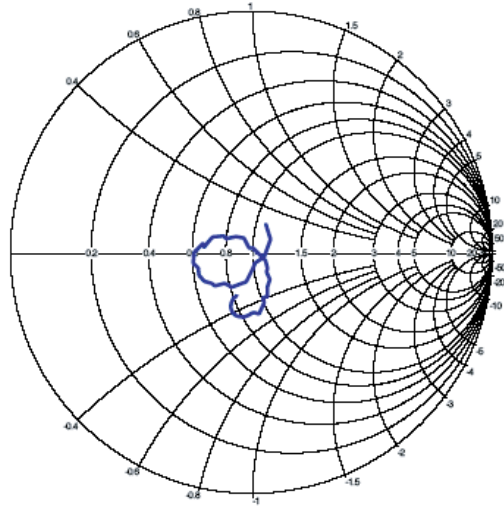

Figure 34. Cell Rx Impedance (S66) in Cell Rx Band.

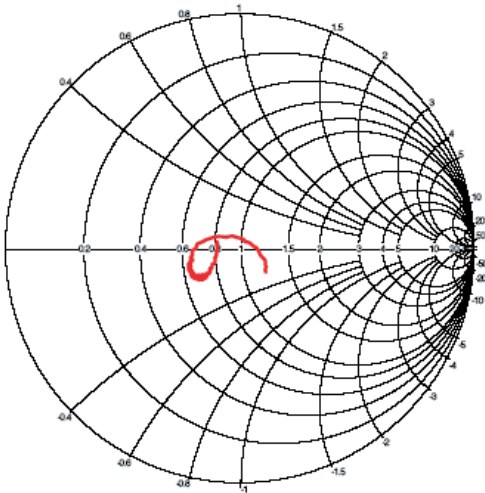

Figure 35. PCS Tx Impedance (S22) in PCS Tx Band.

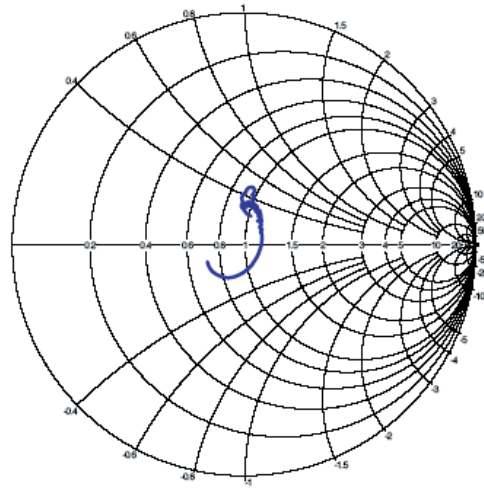

Figure 36. PCS Rx Impedance (S33) in PCS Rx Band.

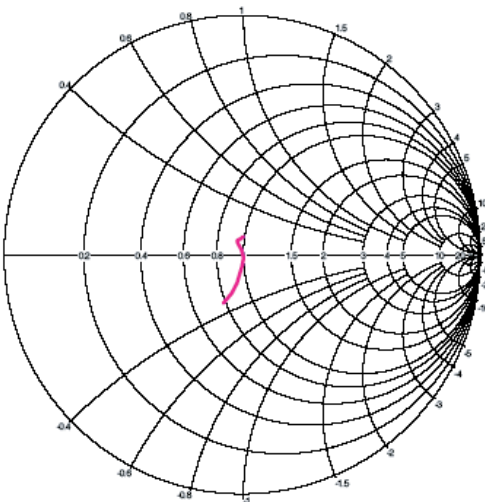
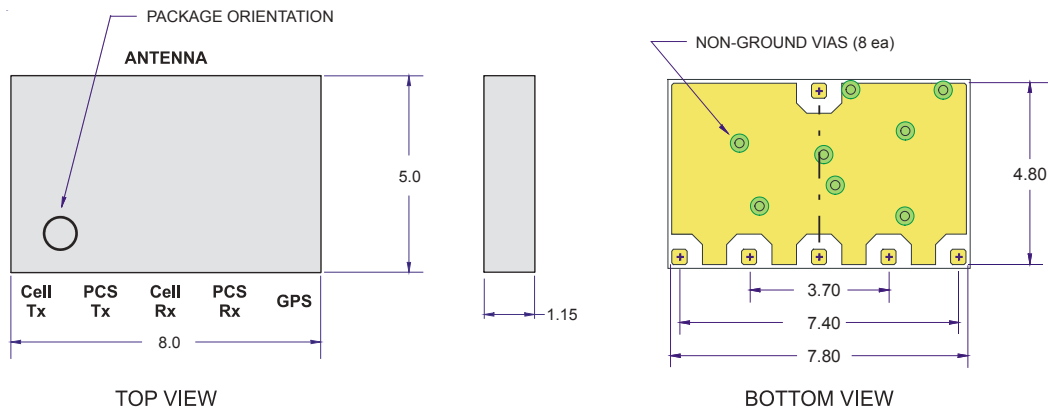
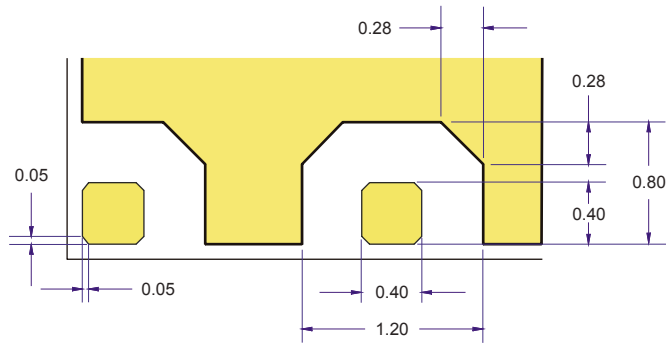

Figure 37. GPS Port Impedance (S44), 1570–1580 MHz.



Notes:

1. Dimensions in mm
2. Tolerance: X.X ± 0.1, X.XX ± 0.05
3. Height = 1.2 mm Max
4. IO pads (6 ea): 0.40 x 0.40, corner chamfer 0.05 x 0.05, pad to ground plane spacing = 0.40
5. Non-ground vias are covered with 0.4 Ø solder mask and are shown for reference only  
Note: PCB metal under non-ground vias does not need to be voided
6. Contact areas are gold plated



DETAIL OF IOPAD AREAS

Figure 38. Package Outline Drawing.

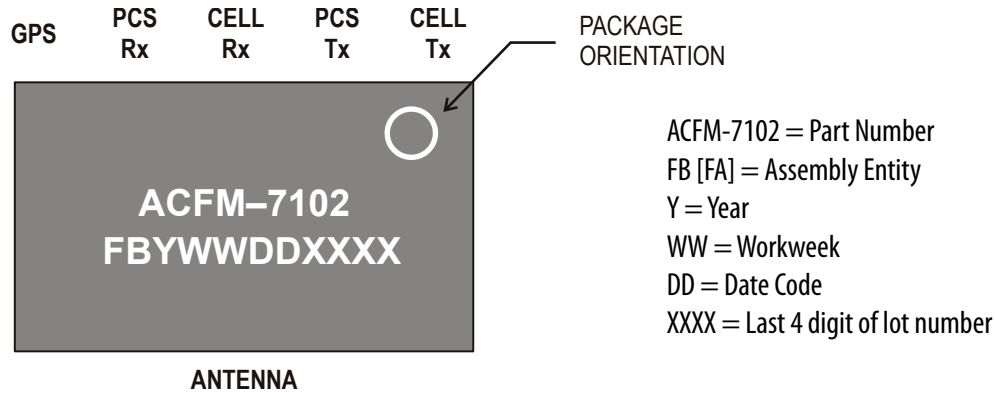
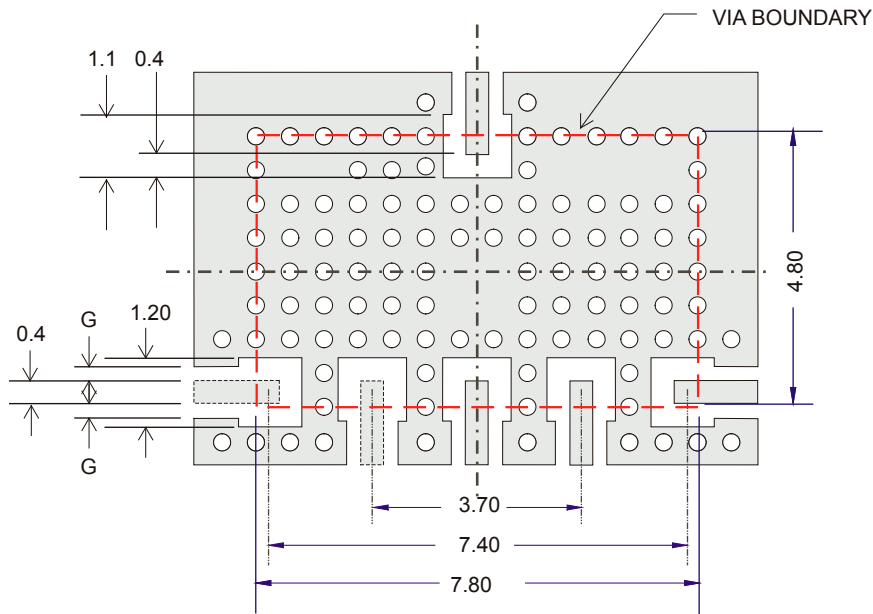

Figure 39. Package Marking.



Notes:

1. Dimensions in mm
2. Gap, G, adjusted so  $Z_0 = 50$  ohms
3. Ground vias are  $\varnothing 0.30$ , aligned to  $0.60 \times 0.60$  grid
4. Via Boundary rectangle  $7.80 \times 4.80$  centered on device location
5. Ground vias positioned for optimum RF performance, port-to-port isolation, and heat sinking
6. Length of lines extending from all ports, especially Ports 2, 3, and 6, should be minimized to maintain port-to-port isolation
7. Lines extending from Ports 4 and 5 should preferably be oriented at  $90^\circ$  relative to Ports 2 and 3 to maintain port-to-port isolation

**Figure 40. Recommended PCB Land Print.**

A PCB layout implementing design features similar to Figure 40 is recommended to optimize performance of the ACFM-7102.

It is particularly important to maximize isolation between the Tx connections to the duplexer and the Rx ports. High isolation is achieved by (1) maintaining a continuous ground plane around the duplexer mounting area, (2) surrounding the I/O ports with sufficient ground vias to enclose the connections in a "Faraday cage", and (3) preferably routing the Tx traces in a different metal layer than the Rx traces.

The latter is especially useful, not only to maintain Tx-Rx isolation of the duplexer, but also to prevent leakage of the Tx signals into other components that could result in the creation of intermodulation products and degradation of overall system performance.

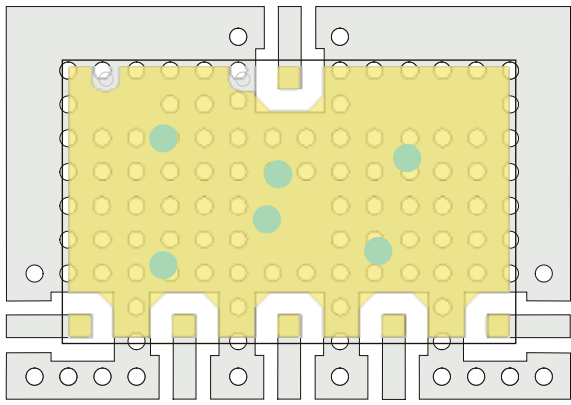

**Figure 41. ACFM-7102 Outline and Bottom Metal Superposed on PCB Land Print.**

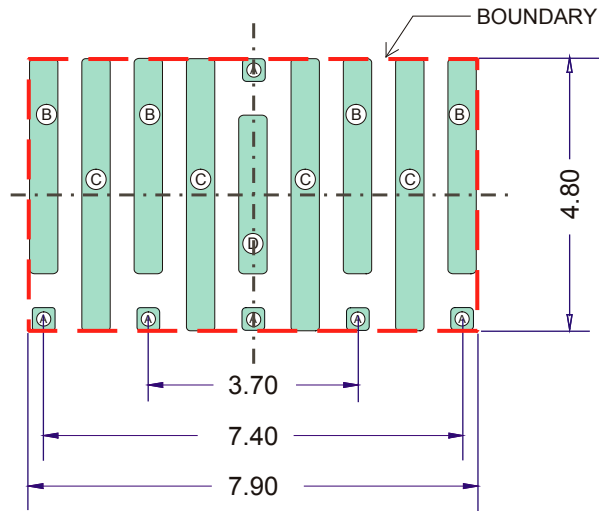

Stencil Opening ID	Qty	Width (mm)	Length (mm)
A (I/O pad areas)	6	0.4	0.4
B	4	0.5	3.8
C	4	0.5	4.8
D	1	0.5	2.8

Notes:

1. Chamfer or radius all corners 0.05 mm min
2. Stencil openings aligned to Boundary rectangle or center lines
3. Stencil openings B-D equally spaced horizontally (spacing = 0.425 mm)

**Figure 43. Recommended Solder Stencil.**

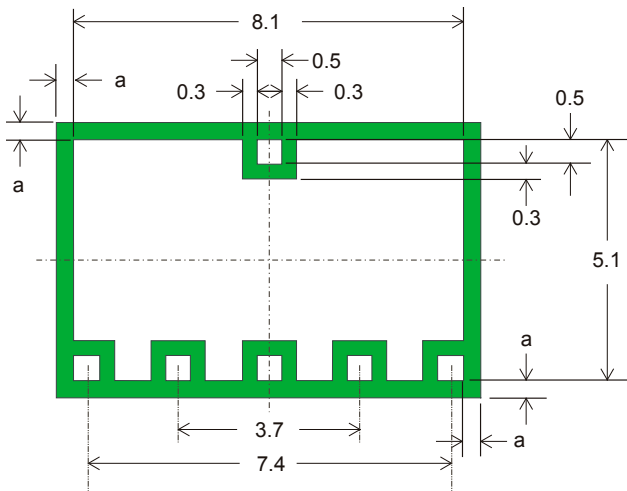

Notes:

1. Dimensions in mm
2.  $a \geq 0.3$  (typ)

**Figure 42. Recommended Solder Mask.**

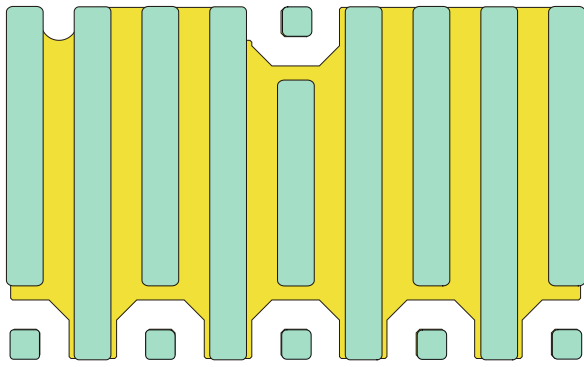

Figure 44. Solder Stencil Overlaid on ACFM-7102 Bottom Metal Pattern.

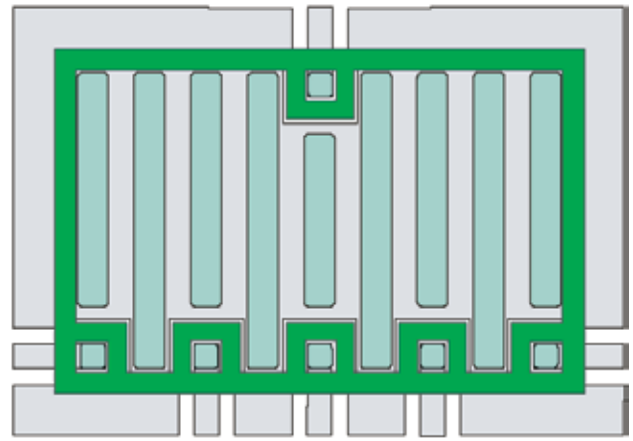

Figure 45. Solder Stencil and Solder Mask Overlaid on PCB Land Print.

### Package Moisture Sensitivity

Feature	Test Method	Performance
Moisture Sensitivity Level (MSL) at 260°C	J-STD-20C	Level 3

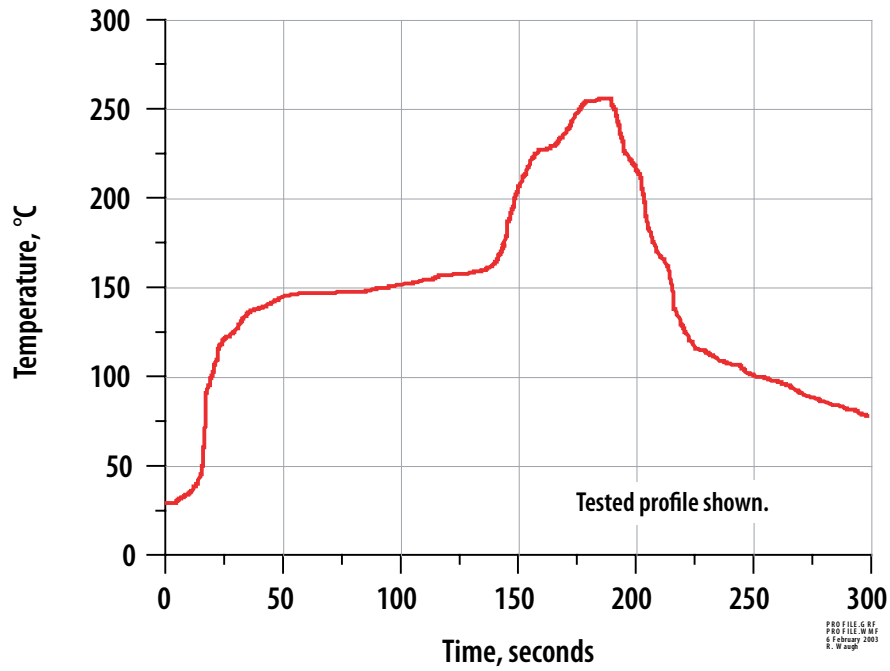

Figure 46. Verified SMT Solder Profile.

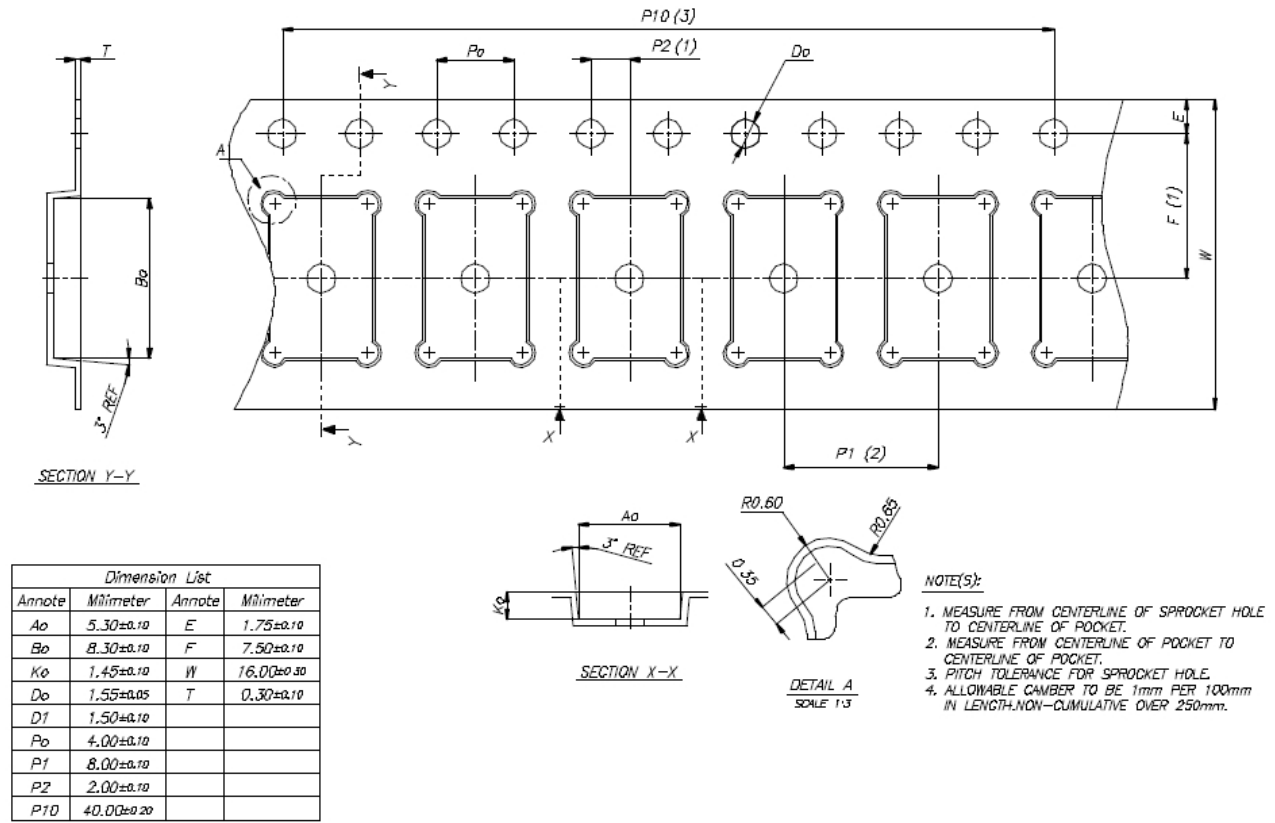

Figure 47. SMT Tape Packing.

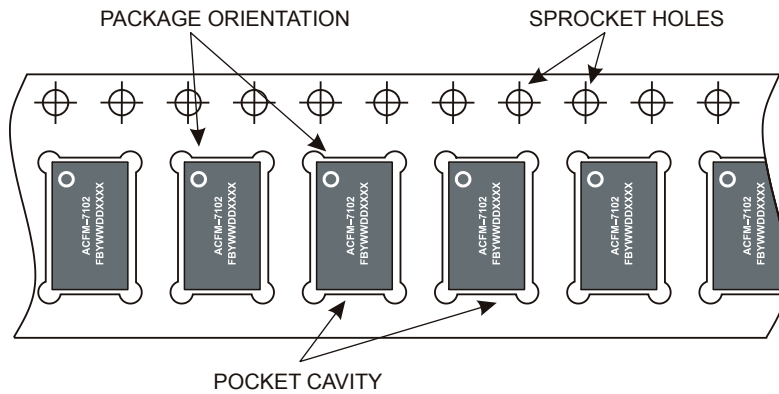

Figure 48. Orientation in Tape.

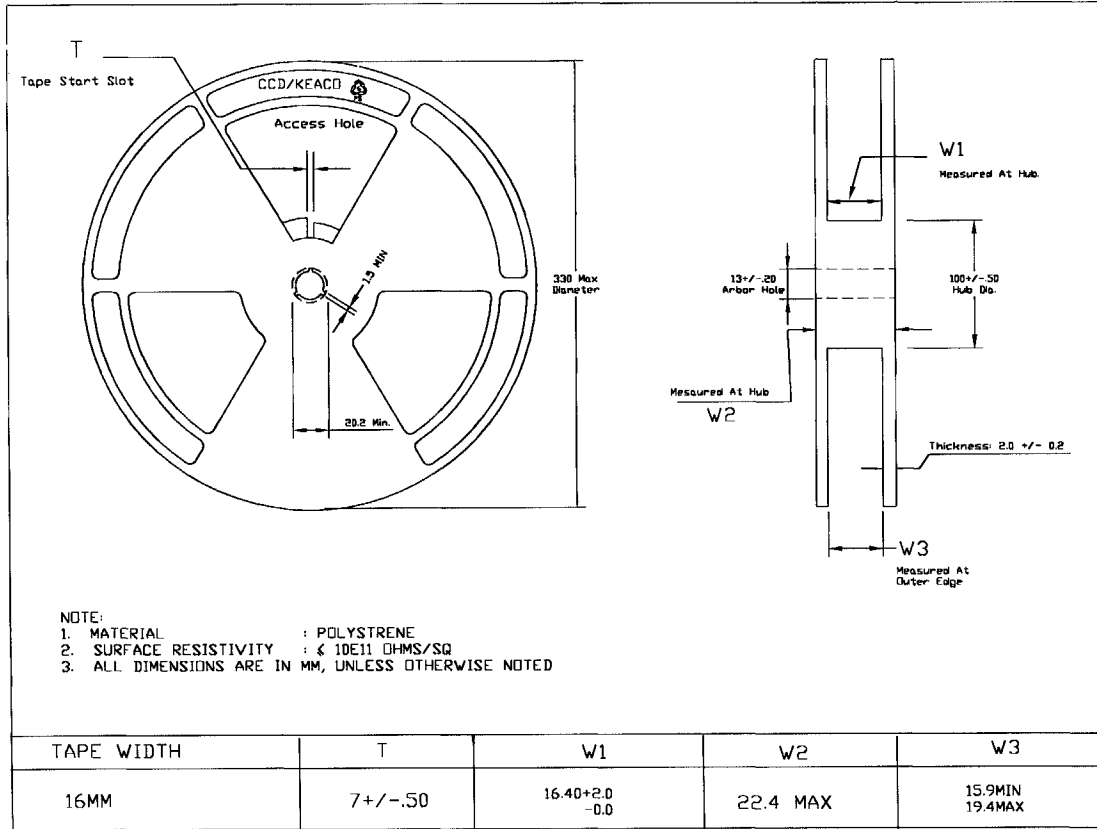

Figure 49. Reel Information.

### ACFM-7102 Ordering Information

Part Number	No. of Devices	Container
ACFM-7102-BLK	25	Anti-static Bag
ACFM-7102-TR1	1000	7-inch Reel

For product information and a complete list of distributors, please go to our web site: [www.avagotech.com](http://www.avagotech.com)

Avago, Avago Technologies, and the A logo are trademarks of Avago Technologies, Limited in the United States and other countries. Data subject to change. Copyright © 2007 Avago Technologies Limited. All rights reserved. AV02-0471EN - June 11, 2007

**AVAGO**  
TECHNOLOGIES