

ACFM-7325

Band Class 14 PCS /

Band Class 10 Cellular Band Quadplexer



Data Sheet

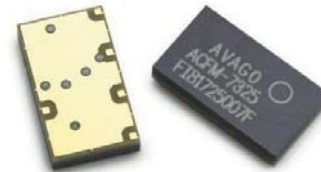

Description

The Avago Technologies' ACFM-7325 is an extended frequency range quadplexer that combines a PCS (Band Class 14) and Cellular (Band Class 10) duplexer into a single, miniature package.

The ACFM-7325 features a single antenna connection, eliminating the need for antenna switching.

The ACFM-7325 is designed with Avago Technologies' Film Bulk Acoustic Resonator (FBAR) technology. The ACFM-7325 also utilizes Avago Technologies' innovative Microcap bonded-wafer, chip scale packaging technology. This process allows the filters to be assembled in a module with a footprint of only 4 x 7 mm with a maximum height of 1.2 mm.

Low Tx Insertion Loss of the ACFM-7325 reduces power amplifier current, extending battery life and talk time. The ACFM-7325 enhances receiver sensitivity and dynamic range with low Rx Insertion Loss and high rejection of Tx signals at the Rx ports.

The excellent power handling capability of Avago Technologies' FBAR bulk-mode resonators supports the high Tx output power levels needed in handsets while adding virtually no distortion

Functional Block Diagram

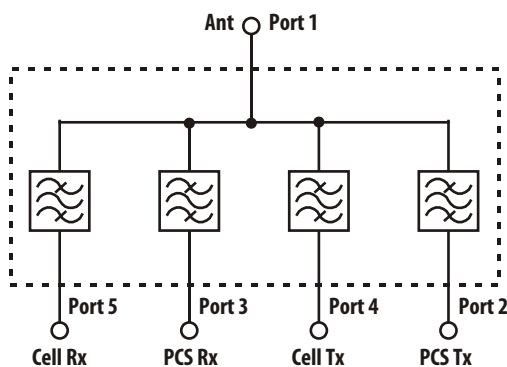

Features

- Extended frequency ranges
 - Band Class 14 PCS
 - Band Class 10 Cellular
- Single Antenna
- Miniature size
 - 4 x 7 mm footprint
 - 1.2 mm Max height
- High Power Rating
 - +33 dBm Max Tx Power
- Environmental
 - RoHS 6 Compliant
 - Halogen Free
 - TBBPA Free

Specifications

- Performance guaranteed -10 to +85° C
- Cellular Duplexer Rx (862 – 894 MHz)
 - Insertion Loss: 3.9 dB Max
 - Noise Blocking: 45 dB Min
- Cellular Duplexer Tx (817 – 849 MHz)
 - Insertion Loss: 2.9 dB Max
 - Interferer Blocking: 55 dB Min
- PCS Duplexer Rx (1930.5 – 1994.45 MHz)
 - Insertion Loss: 4.0 dB Max
 - Noise Blocking: 40 dB Min
- PCS Duplexer Tx (1850.5 – 1914.4 MHz)
 - Insertion Loss: 4.1 dB Max
 - Interferer Blocking: 53 dB Min

Applications

- Handsets or data terminals operating in Band Class 14 PCS and Band Class 10 Cellular frequency bands

ACFM-7325 Electrical Specifications, $Z_0 = 50 \Omega$, TC ^{[1][2][4]} as indicated

Band 10 Class (Cell) Duplexer Performance

Symbol	Parameter	Units	-10° C		+25° C			+85° C	
			Min	Max	Min	Typ ^[3]	Max	Min	Max
Antenna Port to Cellular Receive Port									
S51	Insertion Loss in Rx band (862 – 894 MHz)	dB		3.6		1.5	3.6		3.6
S51	Attenuation in Transmit Band (817 – 849 MHz)	dB	49		49	66		49	
S51	Attenuation, 0 – 772 MHz	dB	25		25	36		25	
S51	Attenuation, 772 – 804 MHz	dB	30		30	47		30	
S51	Attenuation, 1679 – 1743 MHz	dB	30		30	63		30	
S51	Attenuation in Bluetooth Band (2400 – 2500 MHz)	dB	20		20	67		20	
S51	Attenuation, 2496 – 2592 MHz	dB	20		20	48		20	
S55	Return Loss (SWR) of Rx Port in Rx Band (862 – 894 MHz)	dB	8	(2.3)	8	14 (1.5)	(2.3)	8	(2.3)
S11	Return Loss (SWR) of Ant Port in Rx Band (862 – 894 MHz)	dB	8	(2.3)	8	15 (1.4)	(2.3)	8	(2.3)
Cellular Transmit Port to Antenna Port									
S14	Insertion Loss in Transmit Band (817 – 849 MHz)	dB		2.9		1.3	2.9		2.9
S14	Attenuation in Receive Band (862 – 894 MHz)	dB	40		40	57		40	
S14	Attenuation, 0 – 800 MHz	dB	20		20	39		20	
S14	Attenuation in GPS Band (1574.42 – 1576.42 MHz)	dB	35		35	43		35	
S14	Attenuation in Tx 2 nd harmonic Band (1634 – 1698 MHz)	dB	30		30	41		30	
S14	Attenuation in Bluetooth Band (2400 – 2500 MHz)	dB	15		15	25		15	
S14	Attenuation in Tx 3 rd harmonic Band (2451 – 2547 MHz)	dB	15		15	22		15	
S44	Return Loss (SWR) of Tx Port in Tx Band (817 – 849 MHz)	dB	9	(2.1)	9	14 (1.5)	(2.1)	9	(2.1)
S11	Return Loss (SWR) of Ant Port in Tx Band (817 – 849 MHz)	dB	9	(2.1)	9	12 (1.6)	(2.1)	9	(2.1)
Isolation, Cellular Transmit Port to Cellular Receive Port									
S54	Isolation, Tx to Rx port in Rx Band (862–894 MHz)	dB	45		45	58		45	
S54	Isolation, Tx to Rx port in Tx Band (817 – 849 MHz)	dB	55		55	64		55	

ACFM-7325 Electrical Specifications, $Z_0 = 50 \Omega$, T_C [1][2][4] as indicated

Band 14 Class (PCS) Duplexer Performance

Symbol	Parameter	Units	-10° C		+25° C			+85° C	
			Min	Max	Min	Typ ^[3]	Max	Min	Max
Antenna Port to PCS Receive Port									
S31	Insertion Loss in Rx band (1930.5 – 1994.4 MHz)	dB		4.0		1.8	3.6		3.7
S31	Attenuation in Transmit Band (1850.5 – 1914.4 MHz)	dB	50		50	61		50	
S31	Attenuation, 0.03 – 1770 MHz	dB	20		20	40		20	
S31	Attenuation, 2025 – 3700 MHz	dB	27		27	57		27	
S33	Return Loss (SWR) of Rx Port in Rx Band (1930.5 – 1994.4 MHz)	dB	8	(2.3)	8	16 (1.4)	(2.3)	8	(2.3)
S11	Return Loss (SWR) of Ant Port in Rx Band (1930.5 – 1994.4 MHz)	dB	8	(2.3)	8	17 (1.3)	(2.3)	8	(2.3)
PCS Transmit Port to Antenna Port									
S12	Insertion Loss in Transmit Band (1850.5 – 1914.4 MHz)	dB		3.1		1.4	3.1		4.1
S12	Attenuation in Receive Band (1930.5 – 1994.4 MHz)	dB	37		39	49		39	
S12	Attenuation, 0.03 – 1570 MHz	dB	15		15	43		15	
S12	Attenuation in GPS Band (1574.42 – 1576.42 MHz)	dB	27		27	30		27	
S12	Attenuation, 1580 – 1700 MHz	dB	25		25	35		25	
S12	Attenuation in Tx 2 nd harmonic Band (3701 – 3829 MHz)	dB	10		10	23		10	
S12	Attenuation in Tx 3 rd harmonic Band (5551.5 – 5743.5 MHz)	dB	8		8	23		8	
S22	Return Loss (SWR) of Tx Port in Tx Band (1850.5 – 1914.4 MHz)	dB	9.5	(2.0)	9.5	16 (1.4)	(2.0)	9.5	(2.0)
S11	Return Loss (SWR) of Ant Port in Tx Band (1850.5 – 1914.4 MHz)	dB	9	(2.1)	9	16 (1.4)	(2.1)	9	(2.1)
Isolation, PCS Transmit Port to PCS Receive Port									
S32	Isolation, Tx to Rx port in Rx Band (1930.5 – 1994.4 MHz)	dB	40		40	49		40	
S32	Isolation, Tx to Rx port in Tx Band (1850.5 – 1914.4 MHz)	dB	53		53	63		53	

Notes:

1. T_C is defined as Case Temperature, the temperature of the bottom mounting surface of the quadplexer where it makes contact with the circuit board.
2. Min/Max specifications are guaranteed at the indicated temperature with the input power to the Tx ports equal to or less than +29 dBm over all Tx frequencies unless otherwise noted.
3. Typical data is the arithmetic mean value of the parameter over its indicated frequency range at the specified temperature. Typical values may vary over time.
4. Specifications are for circuit shown in Figure 1 and include effect of 5.1 nH inductor and 1.0 pF capacitor added to Port 1 (Ant) via simulation.

Absolute Maximum Ratings^[1]

Parameter	Unit	Value
Storage temperature	°C	-65 to +125
Maximum RF Input Power to Tx Ports	dBm	+33

Maximum Recommended Operating Conditions^[2]

Parameter	Unit	Value
Operating temperature, T_c ^[3] , Tx Power \leq 29 dBm	°C	-40 to +100
Operating temperature, T_c ^[3] , Tx Power \leq 30 dBm	°C	-40 to +85

Notes:

1. Operation in excess of any one of these conditions may result in permanent damage to the device.
2. The device will function over the recommended range without degradation in reliability or permanent change in performance, but is not guaranteed to meet electrical specifications.
3. T_c is defined as Case Temperature, the temperature of the bottom mounting surface of the quadplexer where it makes contact with the circuit board.

ACFM-7325

Applications Information

The ACFM-7325 quadplexer has a single antenna connection common to the both the Cellular and PCS Band duplexers.

Operation

A two-element series-L, shunt-C network is used to match the impedance of the Ant port to 50 ohms as shown in Figure 1.

Matching Components

The nominal values for L and C shown here were selected to match the ACFM-7325 to 50 ohms. Since every application is different, these nominal values may need to be adjusted to provide the best impedance match for the user's particular circuit board, performance requirements, and interface to related components.

The L and C matching components should be located in close proximity to the quadplexer as shown in the recommended PCB layout.

The maximum tolerance for the matching components should be $\pm 5\%$ for the inductor and ± 0.2 pF for the capacitor. The inductor should be of the high Q type (e.g., Murata LQW15AN5N1D00D).

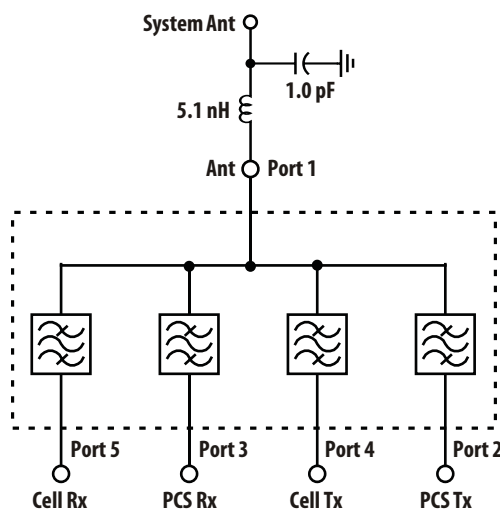

Figure1. Typical Application.

ACFM-7325 Typical Performance at $T_c = 25^\circ\text{C}$. Includes Ant matching, refer to Note 1.

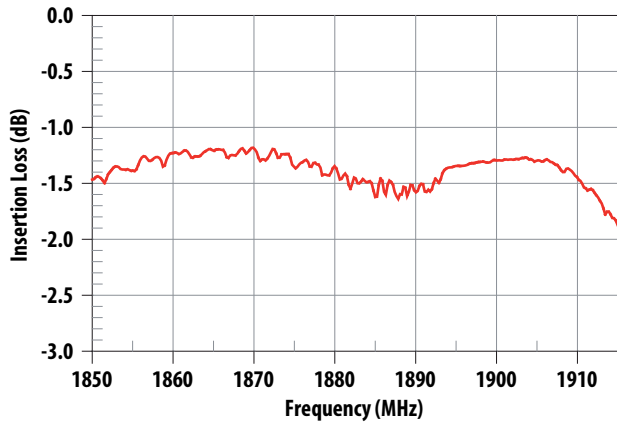

Figure 2. PCS Tx Band Insertion Loss.

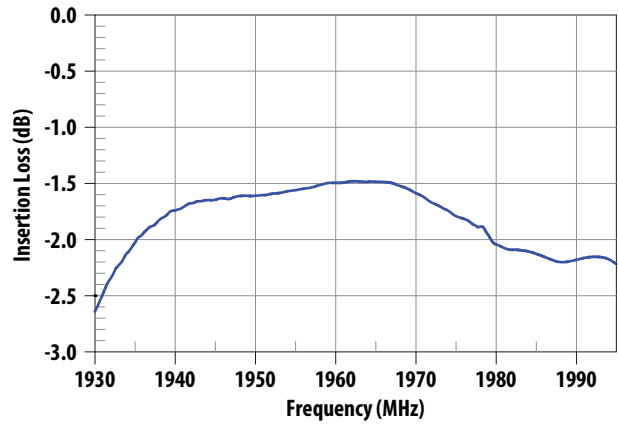

Figure 3. PCS Rx Band Insertion Loss.

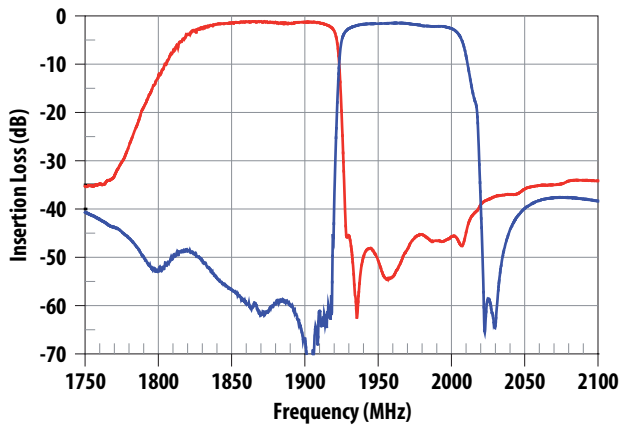

Figure 4. PCS Tx Rejection in Rx Band and Rx Rejection in Tx Band.

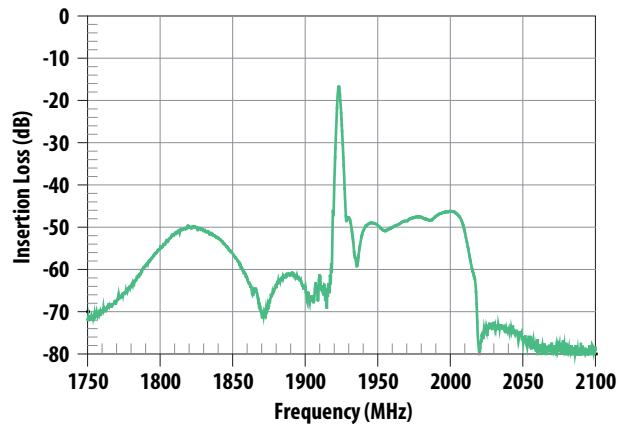

Figure 5. PCS Tx-Rx Isolation.

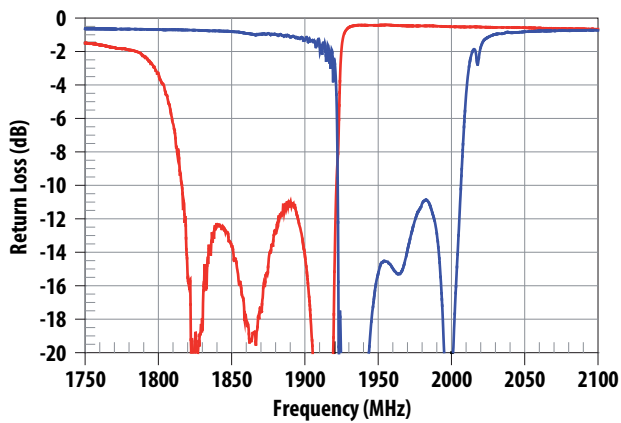

Figure 6. PCS Tx and Rx Port Return Loss.

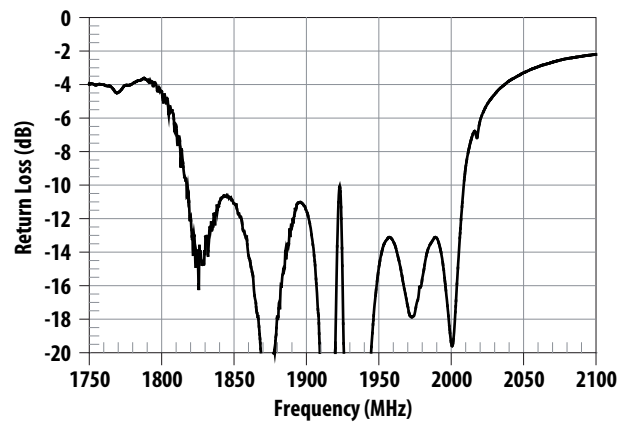

Figure 7. PCS Antenna Port Return Loss.

ACFM-7325 Typical Performance at $T_c = 25^\circ\text{C}$. Includes Ant matching, refer to Note 1.

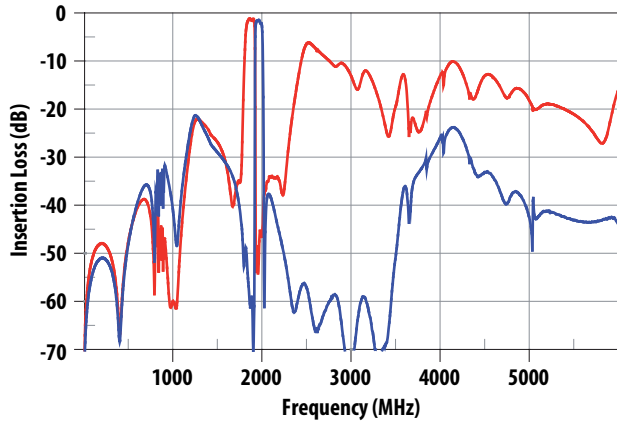

Figure 8. PCS Tx-Ant and Ant-Rx Wideband Insertion Loss.

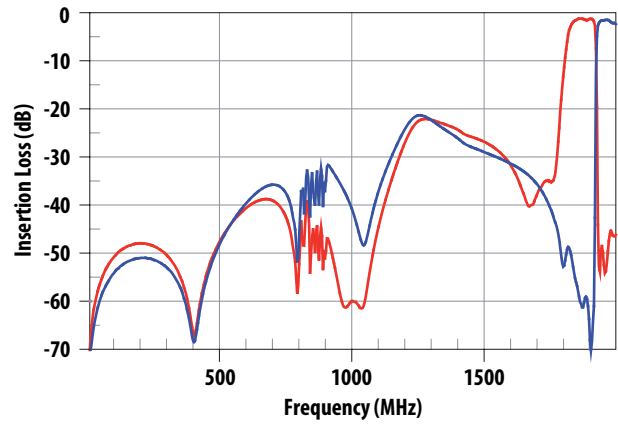

Figure 9. PCS Tx-Ant and Ant-Rx Low Frequency Insertion Loss.

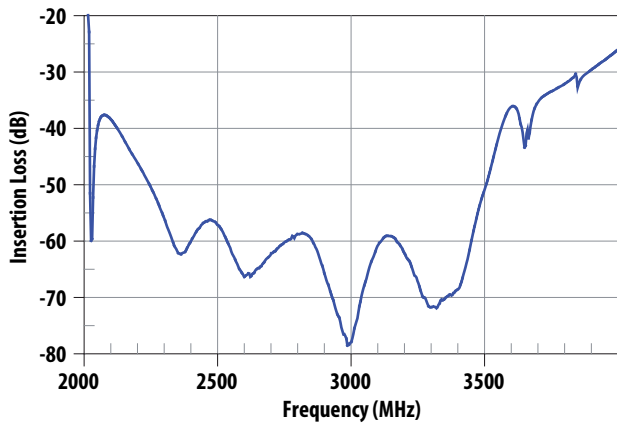

Figure 10. PCS Ant-Rx Rejection, 2000-4000 MHz.

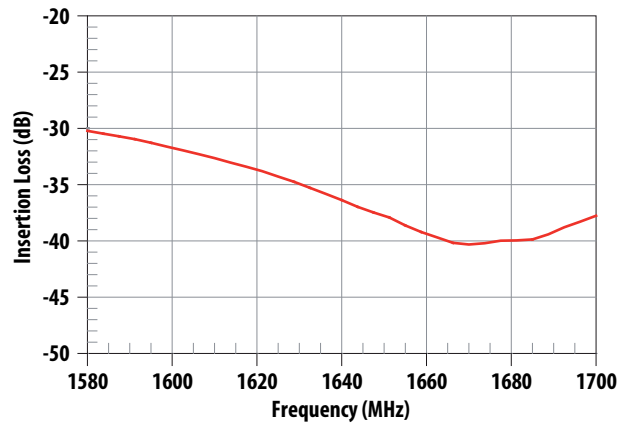

Figure 11. PCS Ant-Tx Rejection, 1580-1700 MHz.

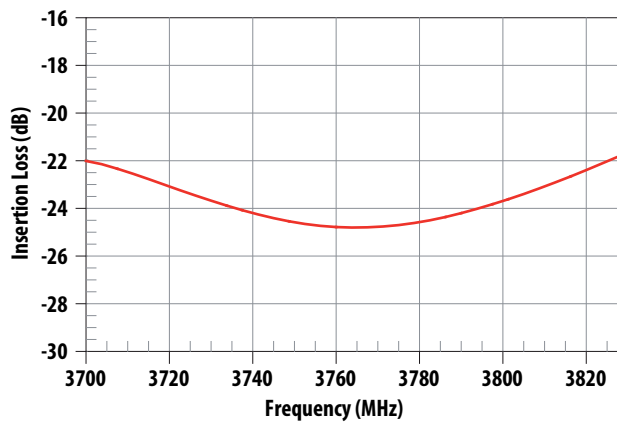

Figure 12. PCS Tx-Ant Rejection at Tx Second Harmonic.

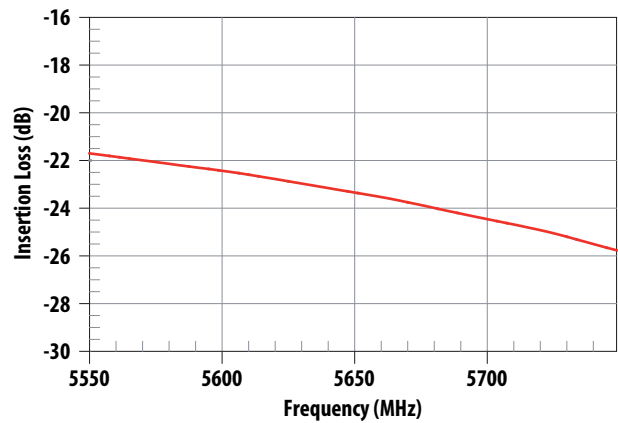

Figure 13. PCS Ant-Tx Rejection at Tx Third Harmonic.

ACFM-7325 Typical Performance at $T_c = 25^\circ\text{C}$. Includes Ant matching, refer to Note 1.

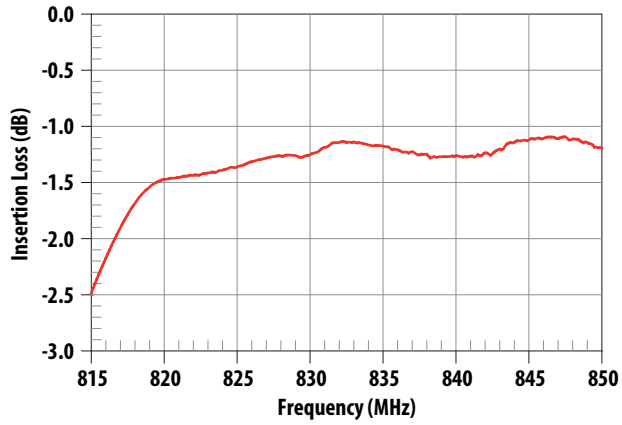

Figure 14. Cellular Tx Insertion Loss.

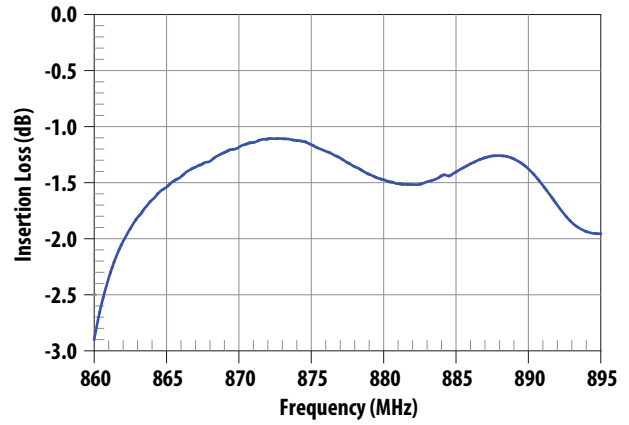

Figure 15. Cellular Rx Insertion Loss.

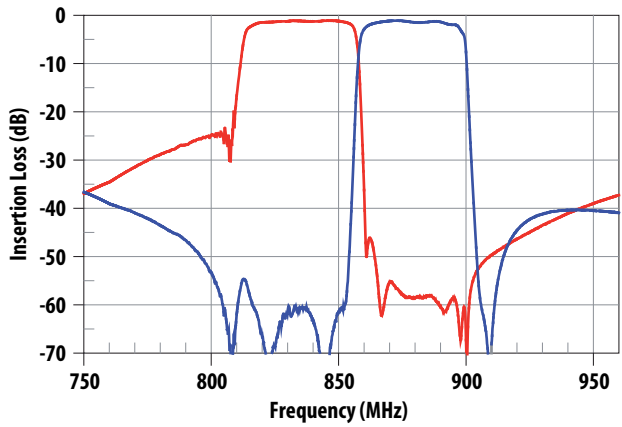

Figure 16. Cellular Tx Rejection in Rx Band and Rx Rejection in Tx Band.

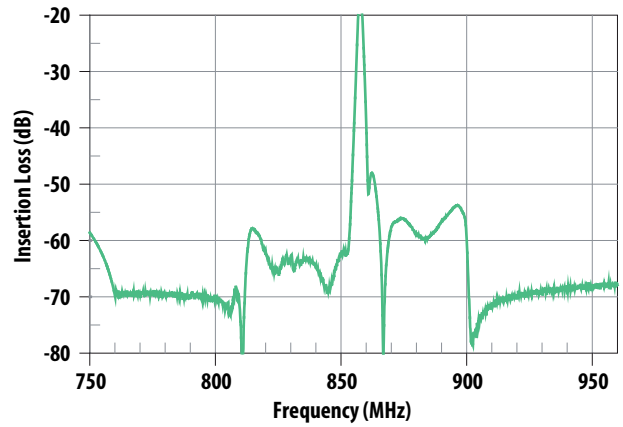

Figure 17. Cellular Tx-Rx Isolation.

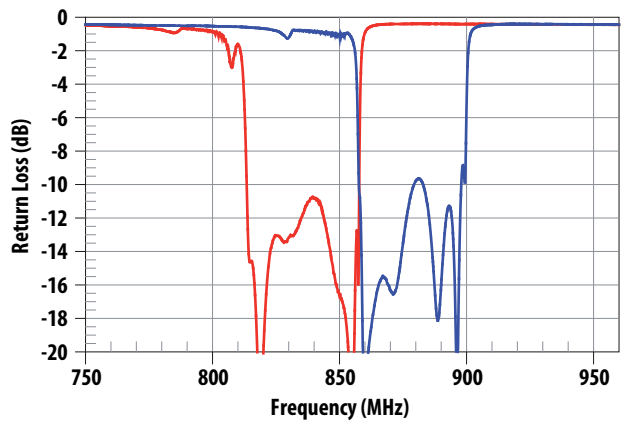

Figure 18. Cellular Tx and Rx Return Loss.

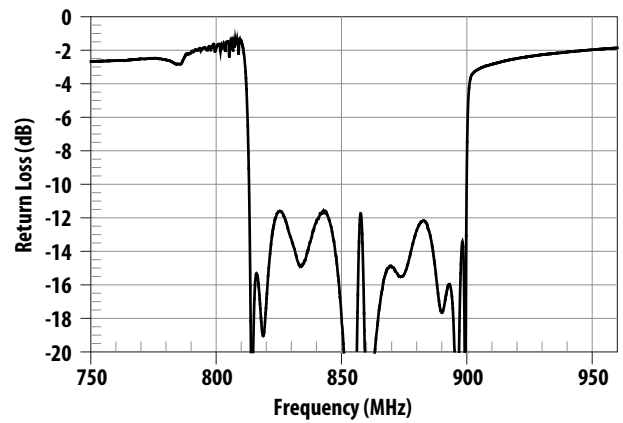

Figure 19. Cellular Band Antenna Return Loss.

ACFM-7325 Typical Performance at $T_c = 25^\circ \text{C}$. Includes Ant matching, refer to Note 1.

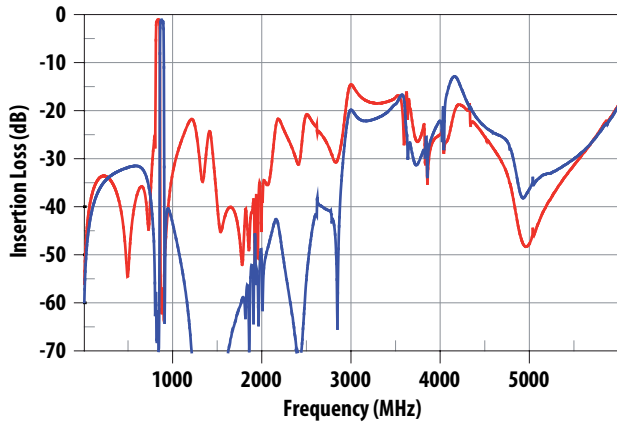

Figure 20. Cellular Tx-Ant and Ant-Rx Wideband Insertion Loss.

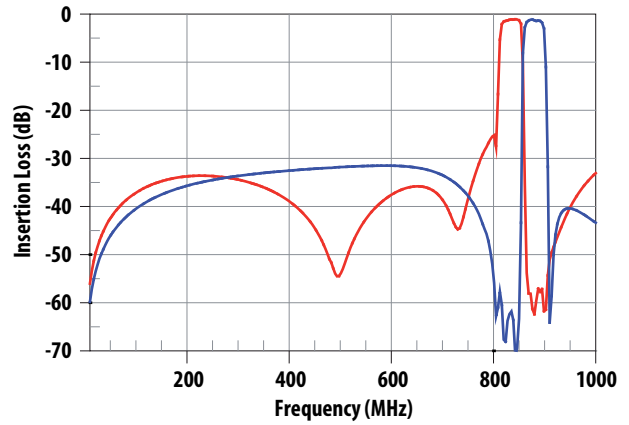

Figure 21. Cellular Tx-Ant and Ant-Rx Low Frequency Insertion Loss.

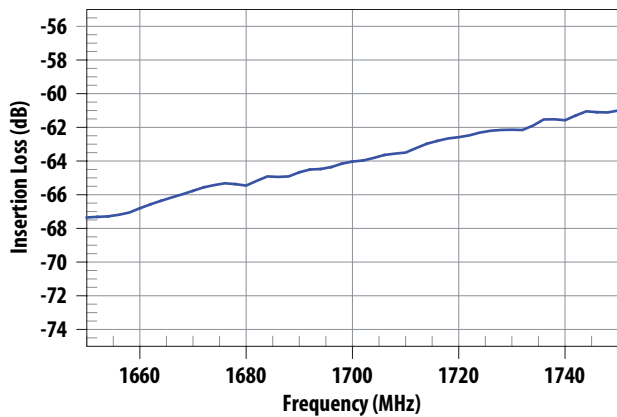

Figure 22. Cellular Ant-Rx Rejection, 1650 – 1750 MHz.

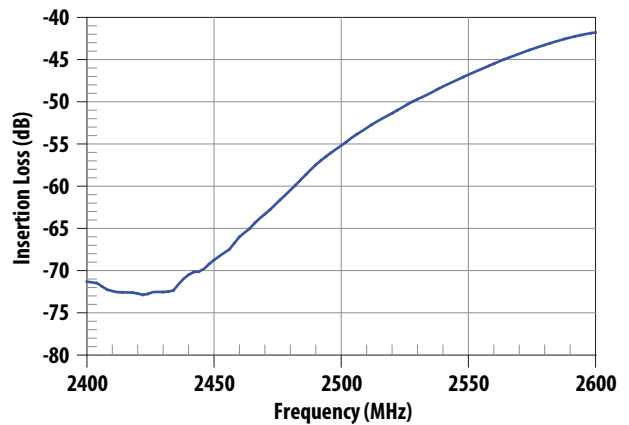

Figure 23. Cellular Tx-Ant and Ant-Rx Rejection, 2400 – 2600 MHz.

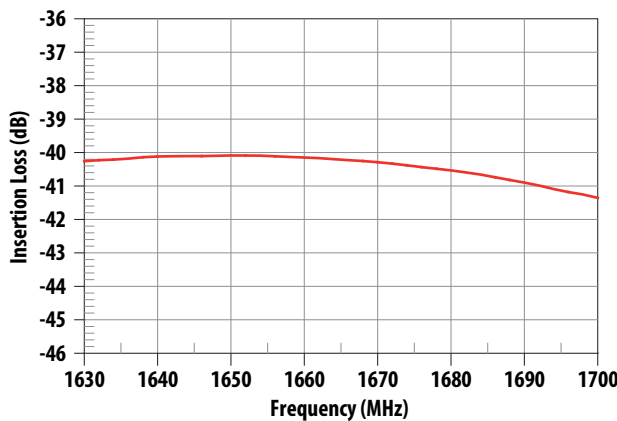

Figure 24. Cellular Tx-Ant Rejection at Tx Second Harmonic.

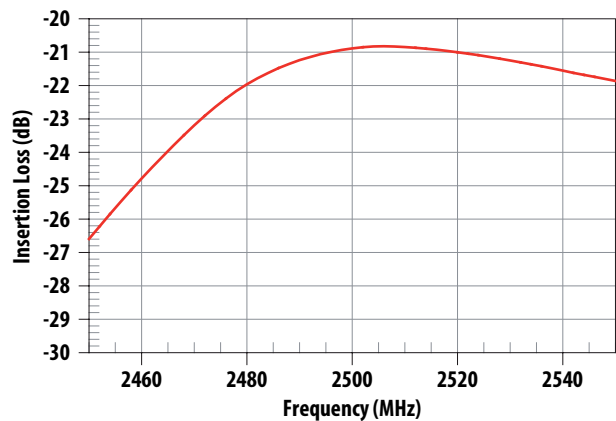

Figure 25. Cellular Tx-Ant Rejection at Tx Third Harmonic.

ACFM-7325 Typical Performance at $T_c = 25^\circ\text{C}$. Includes Ant matching, refer to Note 1.

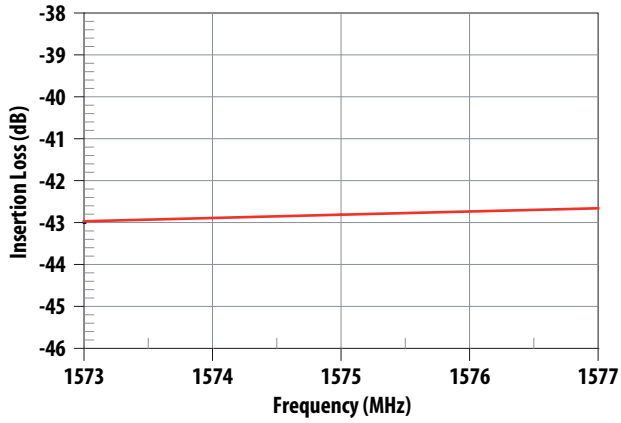

Figure 26. GPS Band Rejection, Cellular Tx-Ant.

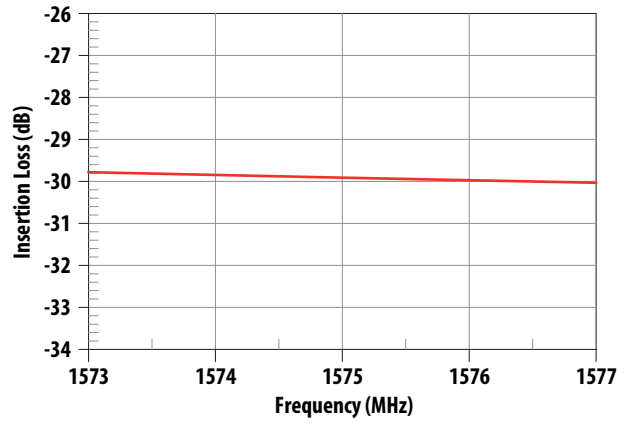

Figure 27. GPS Band Rejection, PCS Tx-Ant.

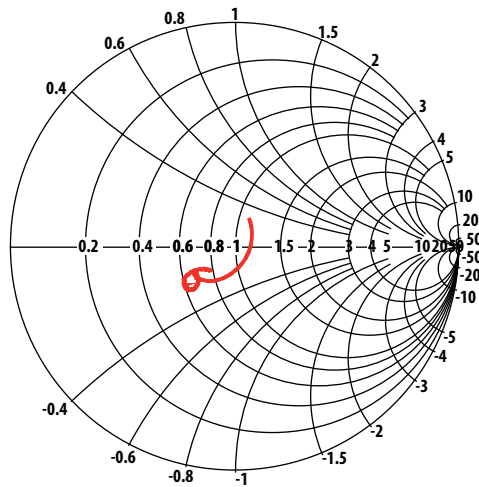

Figure 28. Cell Tx Port Impedance in Tx Band (817-849 MHz).

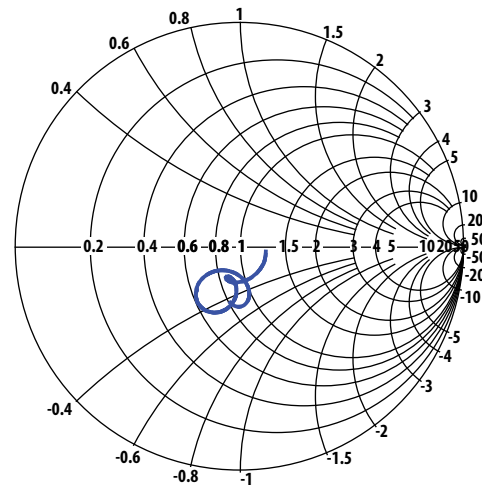

Figure 29. Cell Rx Port Impedance in Rx Band (862-894 MHz).

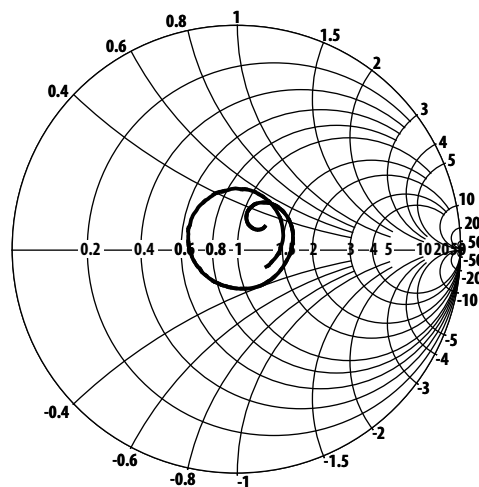

Figure 30. Ant Port Impedance in Tx Band (817-849 MHz).

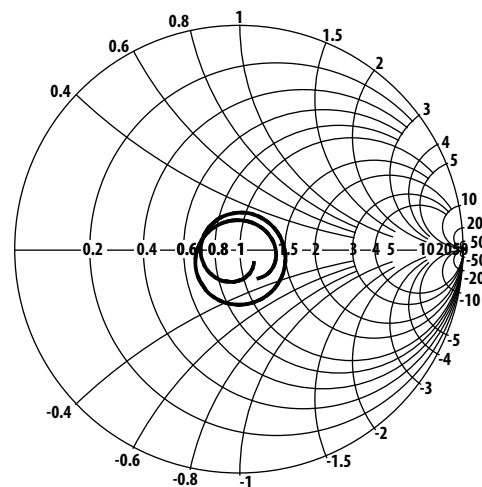

Figure 31. Ant Port Impedance in Rx Band (862-894 MHz).

ACFM-7325 Typical Performance at $T_c = 25^\circ\text{C}$. Includes Ant matching, refer to Note 1.

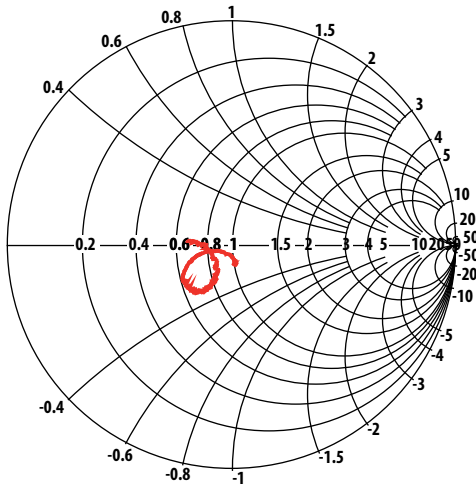

Figure 32. PCS Tx Port Impedance in Tx Band (1850–1915 MHz).

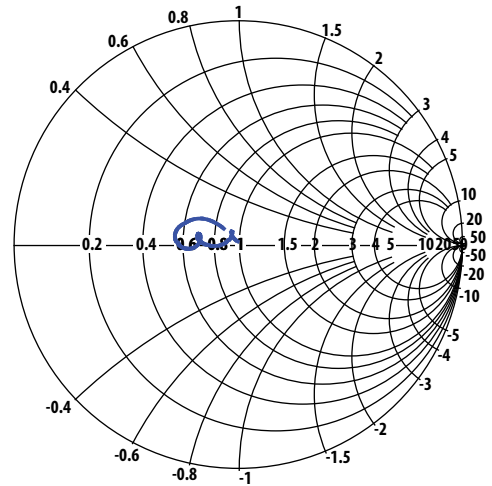

Figure 33. PCS Rx Port Impedance in Rx Band (1930–1995 MHz).

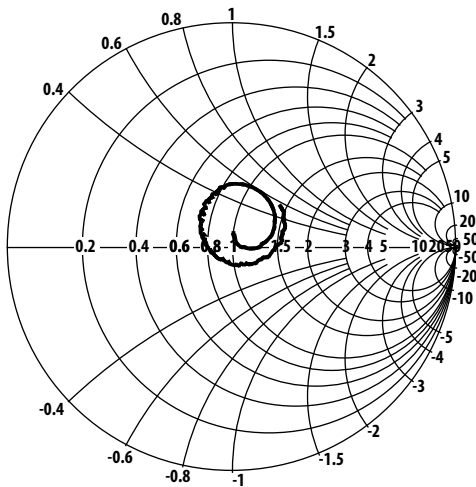

Figure 34. Ant Port Impedance in Tx Band (1850–1915 MHz).

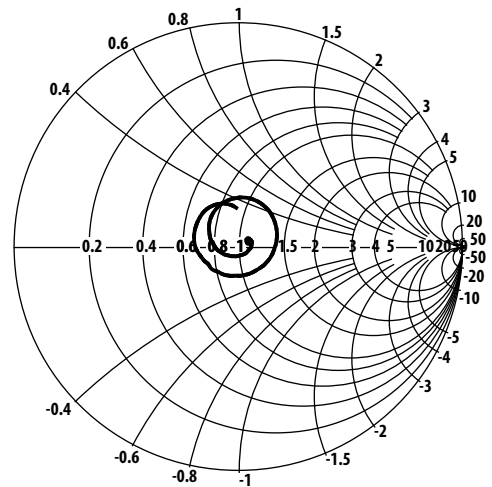

Figure 35. Ant Port Impedance in Rx Band (1930–1995 MHz).

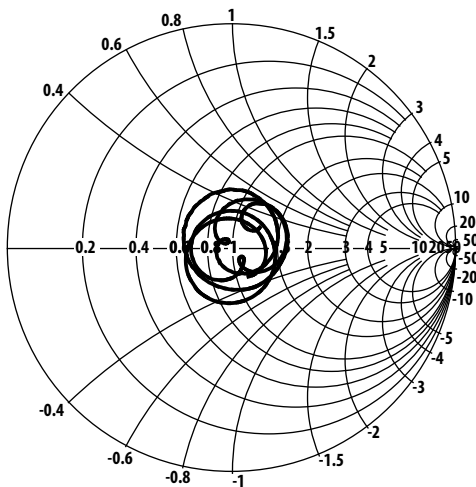

Figure 36. Ant Port Impedance in Cell Tx-Rx Band (817–894 MHz).

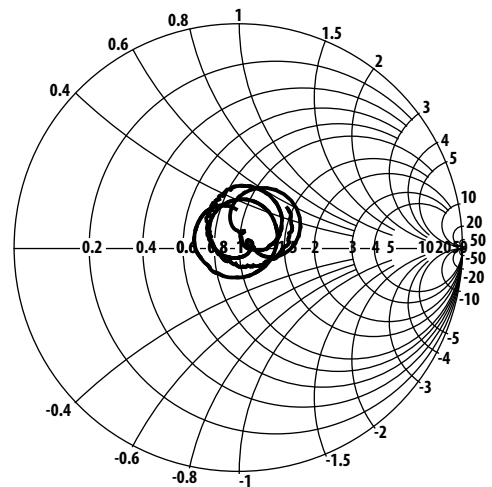
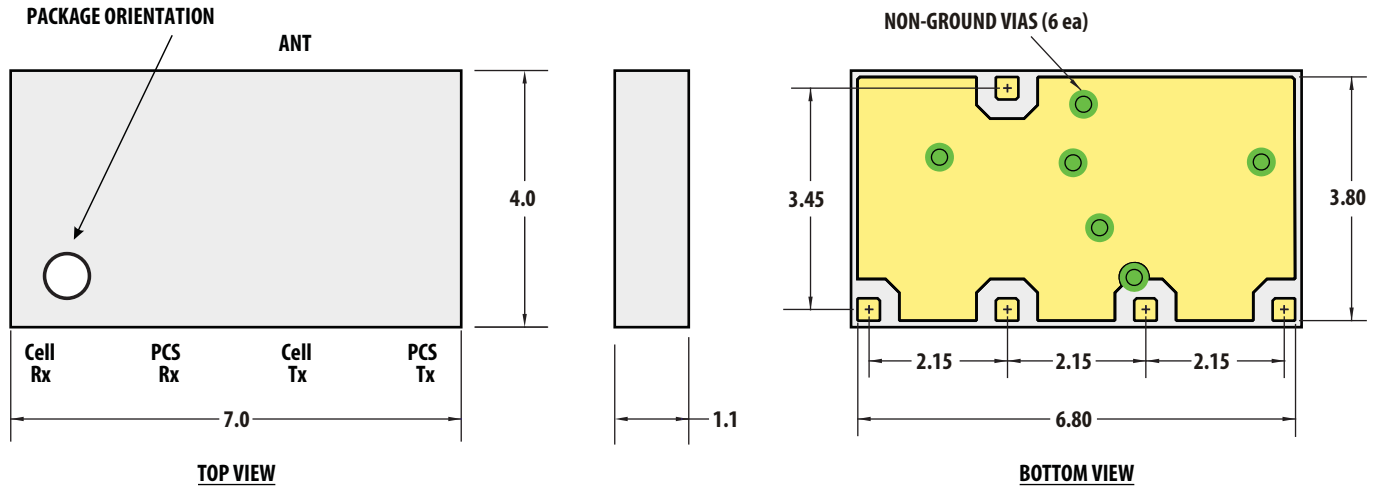

Figure 37. Ant Port Impedance in PCS Tx-Rx Band (1850–1995 MHz).

Notes:

1. Performance shown includes effect of 5.1 nH inductor and 1.0 pF capacitor added to Port 1 (Ant) via simulation as shown in Figure 1.

ACFM-7325



Notes:

1. Dimensions in mm
2. Tolerance: X.X ± 0.1, X.XX ± 0.05
3. Max OD: 4.1 x 7.1 x 1.2 mm
4. IO pads (5 ea), 0.35 x 0.35, pad to ground plane spacing = 0.03
5. Non-ground vias (6 ea) shown for reference only; covered with 0.35 Ø solder mask
Note: PCB metal on mother board under non-ground vias does not need to be voided
6. Contact areas are gold plated

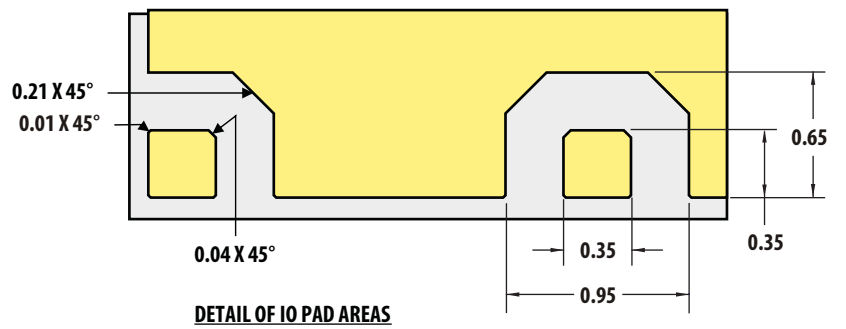

Figure 38. Package Outline Drawing.

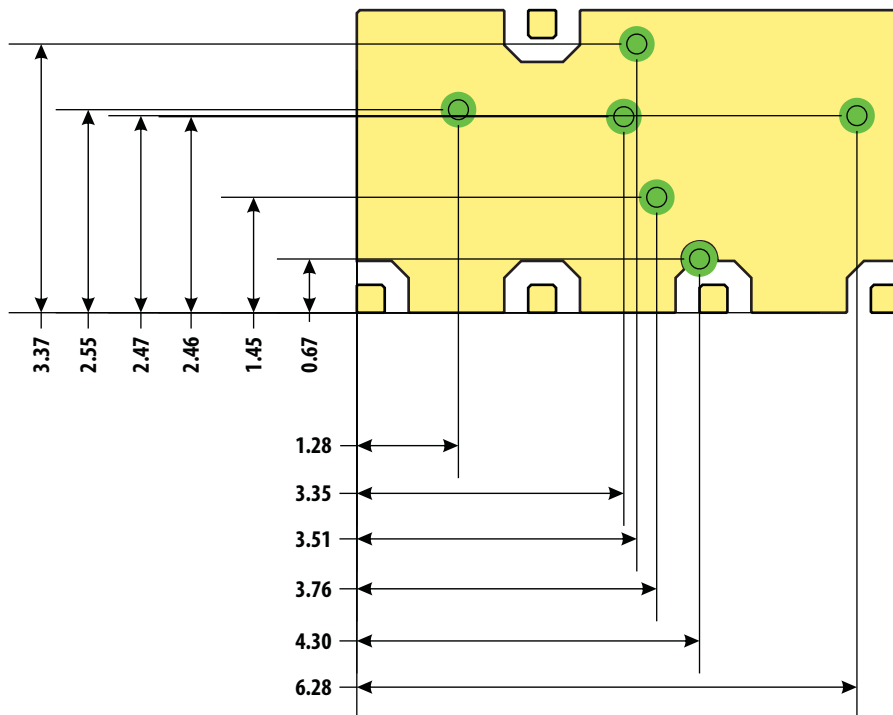
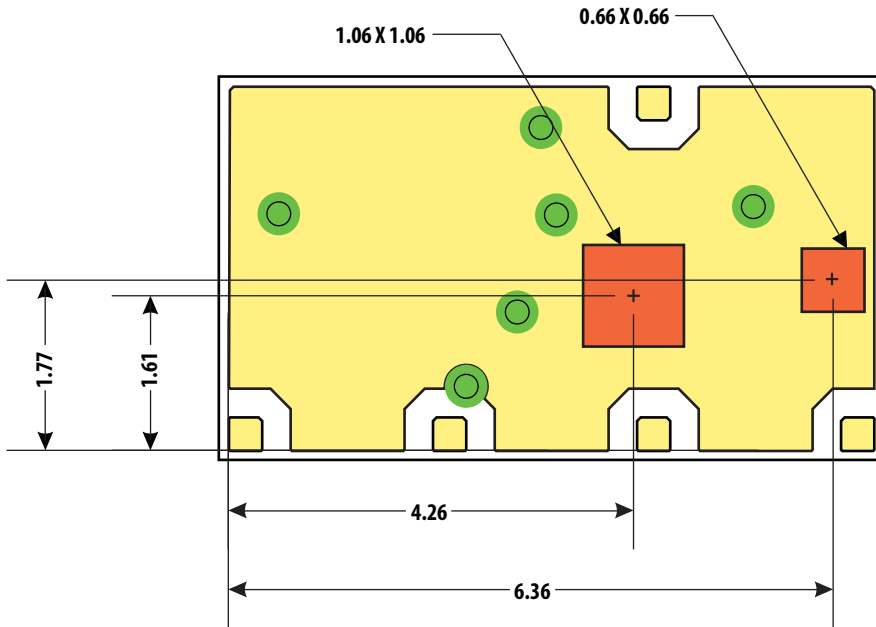

Figure 39. Locations of Non-Ground (Signal) Vias (bottom view).

ACFM-7325



Notes:

1. Dimensions in mm
2. Areas shown are location of transmit filters. Adequate heat sinking should be provided for these areas by means of ground/thermal vias. Heat sink areas on the PCB should be larger than the dimensions shown to allow for thermal spreading.
3. Dimensions are referenced to bottom metal pattern. (Top view)

Figure 40. Location of Heat Sink Areas (top view).

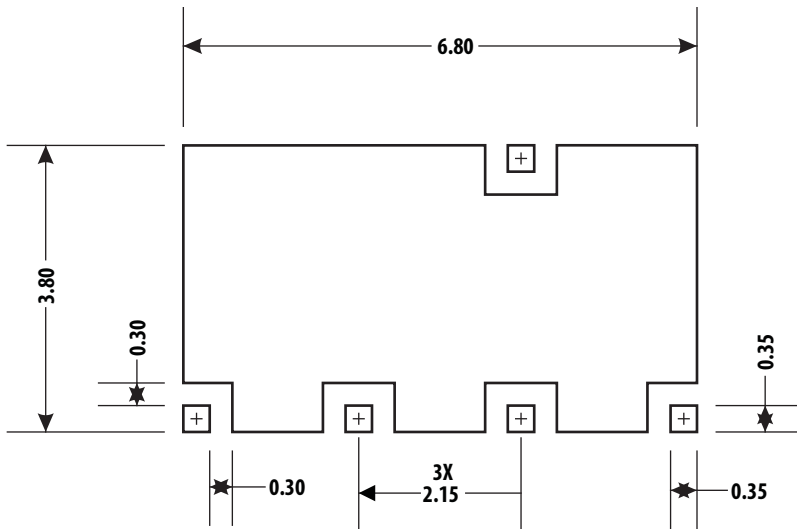

Notes:

1. Dimensions in mm
2. Pads for I/O terminals and ground area are 1:1 with package bottom metal pattern.

Figure 41. PCB Footprint (top view).

ACFM-7325

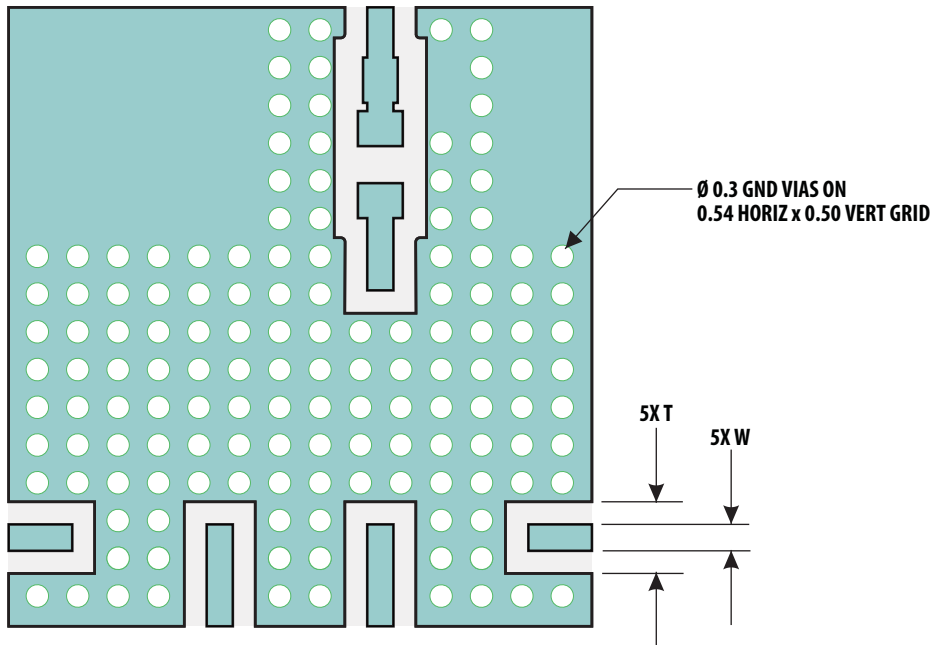

Notes:

1. Dimensions in mm
2. Dimensions W and T should be adjusted for 50-ohm line impedance (beyond the footprint).
3. Includes provision for series inductor and shunt capacitor (0402 size) at Ant terminal.

Figure 42. Recommended PCB Layout (top view).

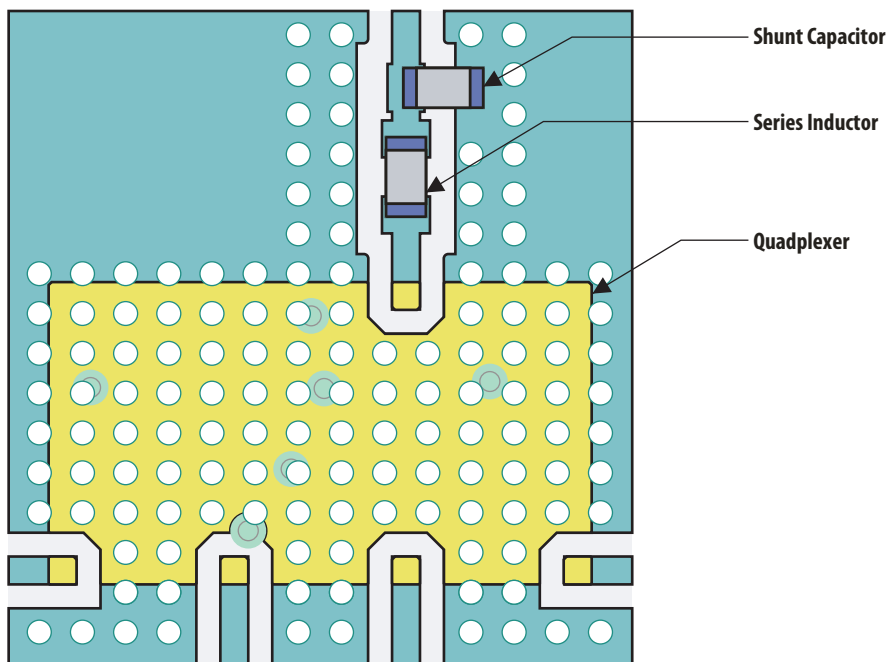

Note:

1. Antenna matching components shown are 0402 size.

Figure 43. PCB Layout with ACFM-7325 and Ant Matching Components Superposed (top view).

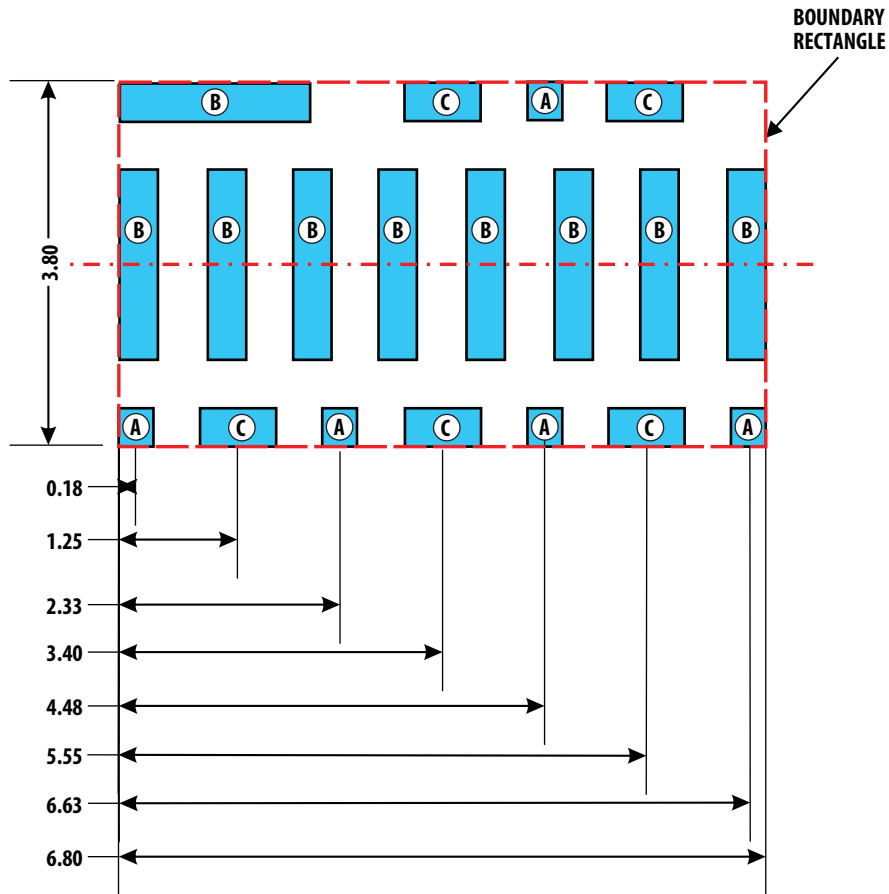

Notes:

1. Dimensions in mm
2. Openings aligned to either Boundary Rectangle or Center Line
3. Openings "B" are equally spaced horizontally. Ref: Spacing = 0.514

Stencil Opening ID	Qty	Width	Height
A (I/O pad areas)	5	0.35	0.35
B	9	0.40	2.00
C	5	0.80	0.40

Figure 45. Recommended Solder Stencil (top view).

The I/O pad openings ("A") in the recommended solder stencil are the same size as the I/O pad metal patterns on the ACFM-7325.

The stencil pattern for the large ground pad area is divided into smaller openings ("B" through "C") for the purpose of reducing the volume of solder paste. The use of smaller apertures reduces risk of solder voiding as well as preventing the device from "floating" during reflow.

ACFM-7325

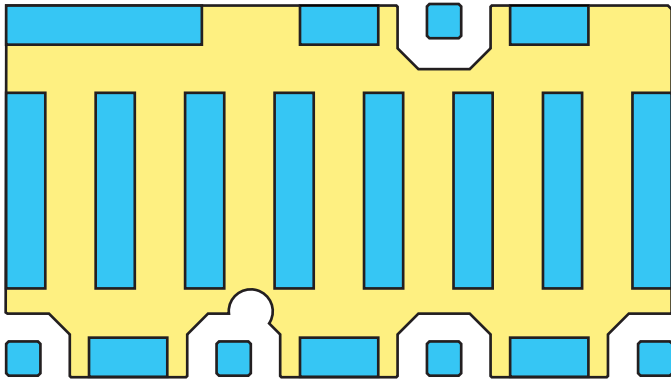

Figure 46. Solder Stencil Superposed on ACFM-7325 Bottom Metal Pattern. (top view)

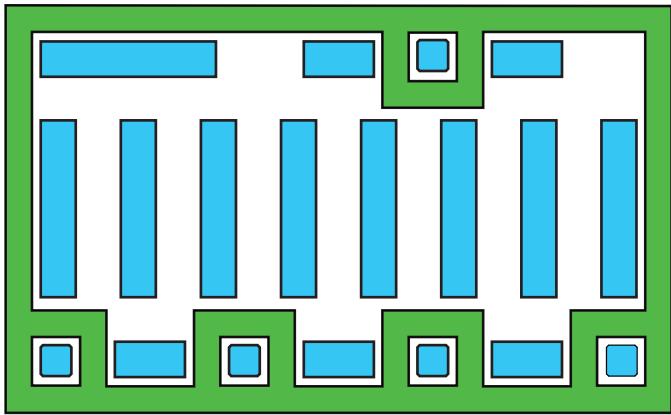

Figure 47. Solder Mask Superposed on Solder Stencil. (top view)

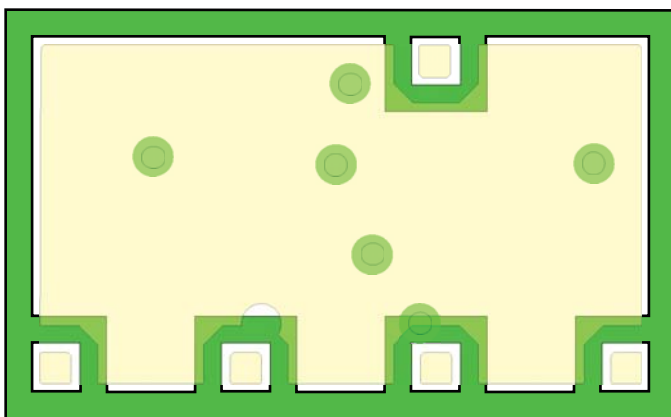

Figure 48. Solder Mask Superposed on ACFM-7325 Bottom Metal Pattern. (top view)

ACFM-7325

Package Moisture Sensitivity

Feature	Test Method	Performance
Moisture Sensitivity Level (MSL) at 260° C	J-STD-20C	Level 3

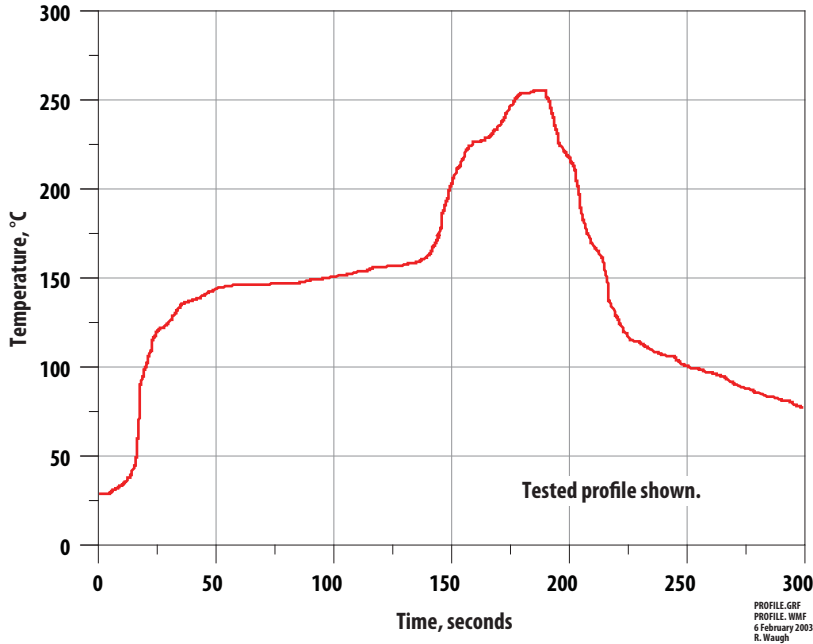

Figure 49. Verified SMT Solder Profile.

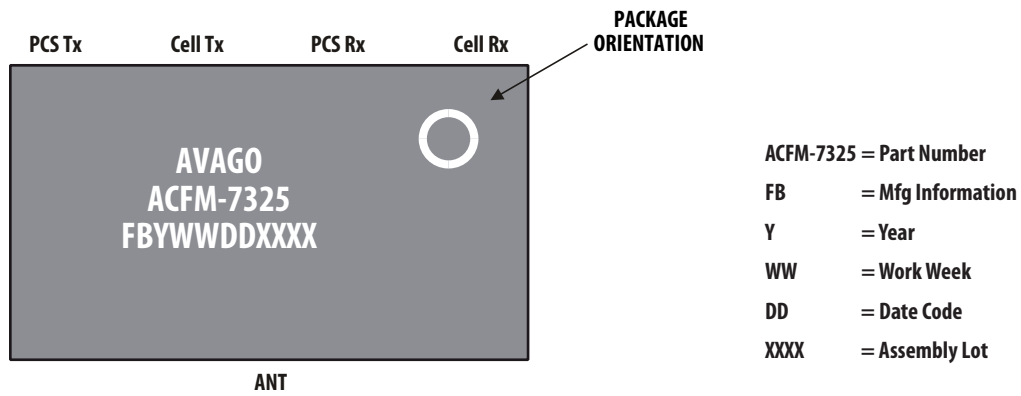

Figure 50. Package Marking

ACFM-7325

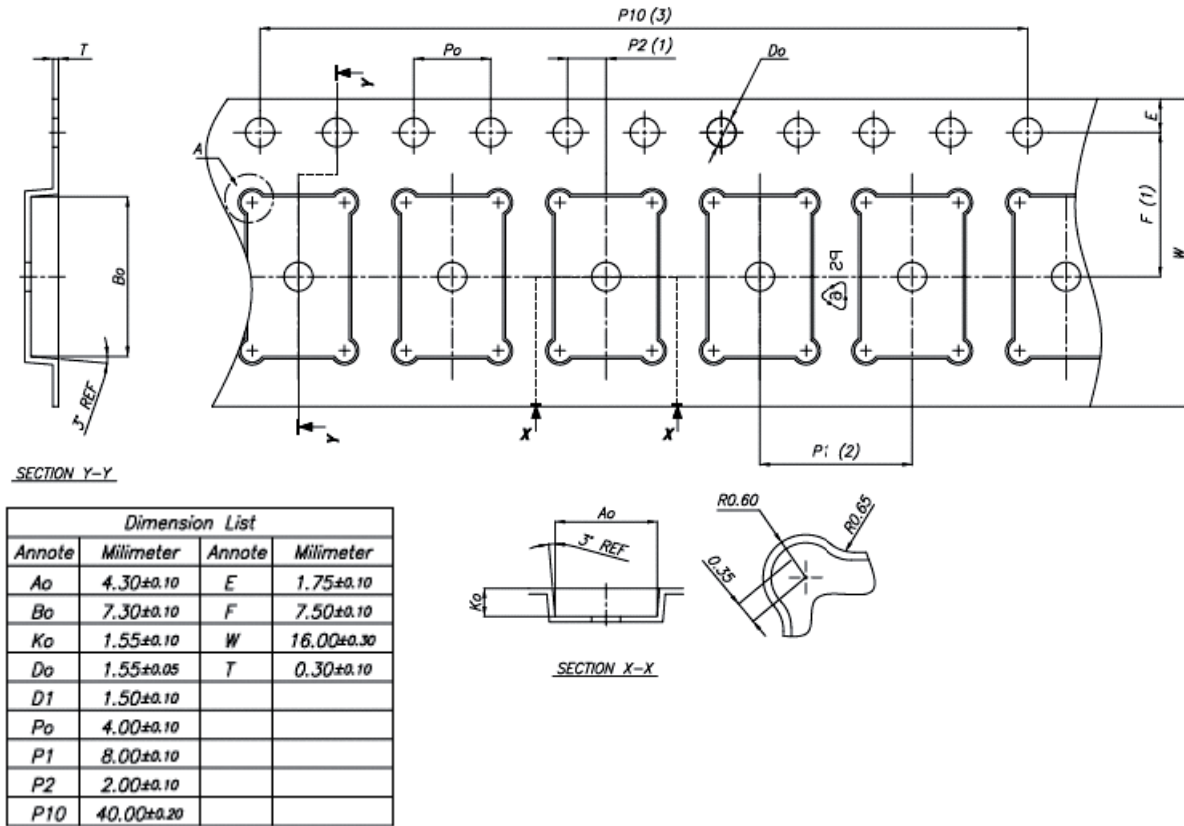

Figure 51. SMT Tape Packing (16 mm tape).

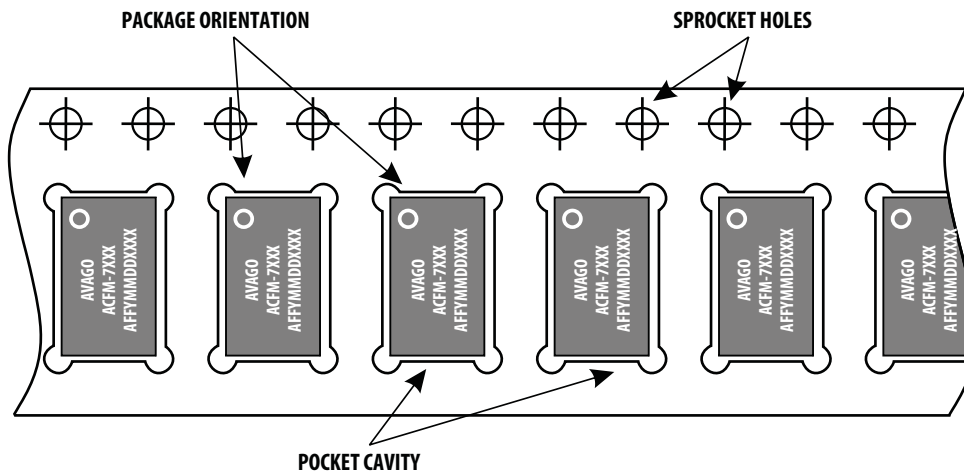
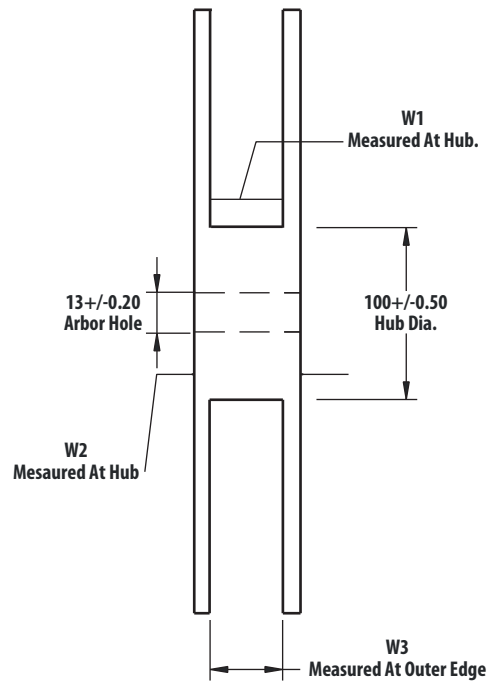
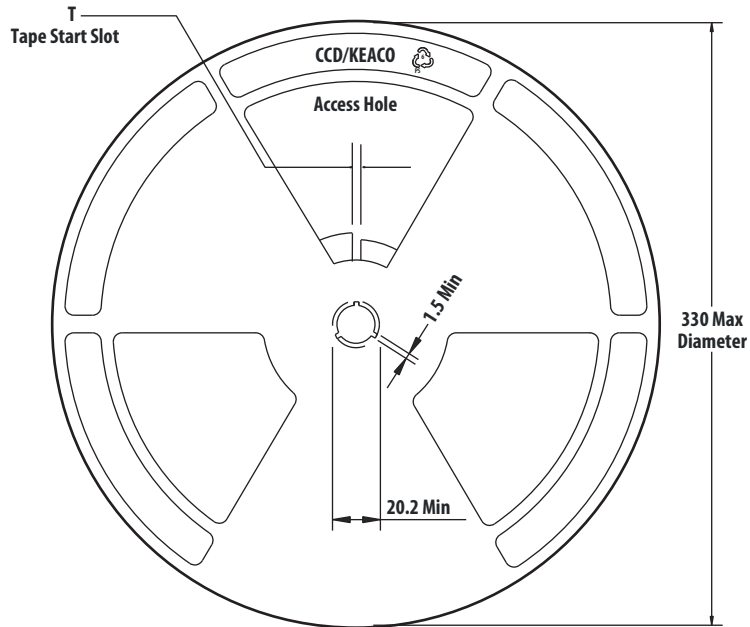

Figure 52. Orientation in Tape

ACFM-7325



NOTE:
44 MM HUB DIE
152 +/- .50

TAPE WIDTH	T	W1	W2	W3
16 MM	7 +/- 0.50	16.4 ^{+2.0} / _{-0.0}	22.4 Max	15.9 Min 19.4 Max

Figure 53. Reel Drawing

Ordering Information

Part Number	No. of Devices	Container
ACFM-7325-BLK	100	Tape Strip or Anti-static Bag
ACFM-7325-TR1	3000	13-inch (330 mm) Reel

For product information and a complete list of distributors, please go to our web site: www.avagotech.com

Avago, Avago Technologies, and the A logo are trademarks of Avago Technologies in the United States and other countries. Data subject to change. Copyright © 2005-2011 Avago Technologies. All rights reserved. AV02-2892EN - March 29, 2011

