



**ACMD-6007 Electrical Specifications <sup>[2]</sup>, Z<sub>0</sub>=50 Ω, T<sub>c</sub><sup>[1]</sup> as indicated**

Symbol	Parameter	Units	-20°C			+25°C			+85°C		
			Min	Typ <sup>[3]</sup>	Max	Min	Typ <sup>[3]</sup>	Max	Min	Typ <sup>[3]</sup>	Max
<b>Antenna Port to Receive Port</b>											
S23	Insertion Loss in Receive Band (2620 – 2690 MHz)	dB			2.5		1.6	2.5			2.5
S22	Return Loss (SWR) of Receive Port in Receive Band (2620 – 2690 MHz)	dB	9.5		(2.0)	9.5	17 (1.3)	(2.0)	9.5		(2.0)
S23	Attenuation in Transmit Band (2500 – 2570 MHz)	dB	45			45	57		45		
S23	Attenuation, 1 – 2380 MHz	dB	30			30	32		30		
S23	Attenuation, 2380 – 2450 MHz	dB	35			35	48		35		
S23	Attenuation, 2450 – 2484 MHz	dB	35			35	51		35		
S23	Attenuation, 2775 – 6000 MHz	dB	20			20	38		20		
<b>Transmit Port to Antenna Port</b>											
S31	Insertion Loss in Transmit Band (2500 – 2570 MHz)	dB			2.0		1.8	2.0			2.1
S11	Return Loss (SWR) of Transmit Port in Transmit Band (2500 – 2570 MHz)	dB	10		(1.9)	10	18 (1.3)	(1.9)	10		(1.9)
S31	Attenuation in Receive Band (2620 – 2690 MHz)	dB	45			45	58		45		
S31	Attenuation, 10 – 1574 MHz	dB	30			30	42		30		
S31	Attenuation in GPS Rx Band (1574.42 – 1576.42 MHz)	dB	45			45	57		45		
S31	Attenuation, 1577 – 1680 MHz	dB	25			25	50		25		
S31	Attenuation, 1845 – 1880 MHz	dB	30			30	42		30		
S31	Attenuation, 2110 – 2170 MHz	dB	30			30	34		30		
S31	Attenuation, 2400 – 2450 MHz	dB	30			30	57		30		
S31	Attenuation in Transmit 2 <sup>nd</sup> Harmonic Band (5000 – 5140 MHz)	dB	20			20	39		20		
S31	Attenuation, 5150 – 5850 MHz	dB	20			20	35		20		
S31	Attenuation, 7500 – 7710 MHz	dB	20			20	37		20		
<b>Antenna Port</b>											
S33	Return Loss (SWR) of Ant Port in Rx Band (2620 – 2690 MHz)	dB	10		(1.9)	10	18 (1.3)	(1.9)	10		(1.9)
S33	Return Loss (SWR) of Ant Port in Tx Band (2500 – 2570 MHz)	dB	10		(1.9)	10	16 (1.3)	(1.9)	10		(1.9)
<b>Isolation Transmit Port to Receive Port</b>											
S21	Tx-Rx Isolation in Receive Band (2620 – 2690 MHz)	dB	50			50	58		50		
S21	Tx-Rx Isolation in Transmit Band (2500 – 2570 MHz)	dB	55			55	61		55		

Notes:

1. T<sub>c</sub> is the case temperature and is defined as the temperature of the underside of the Duplexer where it makes contact with the circuit board.
2. Min/Max specifications are guaranteed at the indicated temperature with the input power to the Tx ports equal to or less than +29 dBm over all Tx frequencies unless otherwise noted.
3. Typical data is the average value of the parameter over the indicated band at the specified temperature. Typical values may vary over time.

### Absolute Maximum Ratings<sup>[1]</sup>

Parameter	Unit	Value
Storage temperature	°C	-65 to +125
Maximum RF Input Power to Tx Port	dBm	+33

### Maximum Recommended Operating Conditions<sup>[2]</sup>

Parameter	Unit	Value
Operating temperature, $T_C$ <sup>[3]</sup> , Tx Power $\leq$ 29 dBm, CW	°C	-40 to +100
Operating temperature, $T_C$ <sup>[3]</sup> , Tx Power $\leq$ 30 dBm, CW	°C	-40 to +85

Notes:

1. Operation in excess of any one of these conditions may result in permanent damage to the device.
2. The device will function over the recommended range without degradation in reliability or permanent change in performance, but is not guaranteed to meet electrical specifications.
3.  $T_C$  is defined as case temperature, the temperature of the underside of the duplexer where it makes contact with the circuit board.

### ACMD-6007 Typical Performance at $T_C = 25^\circ\text{C}$

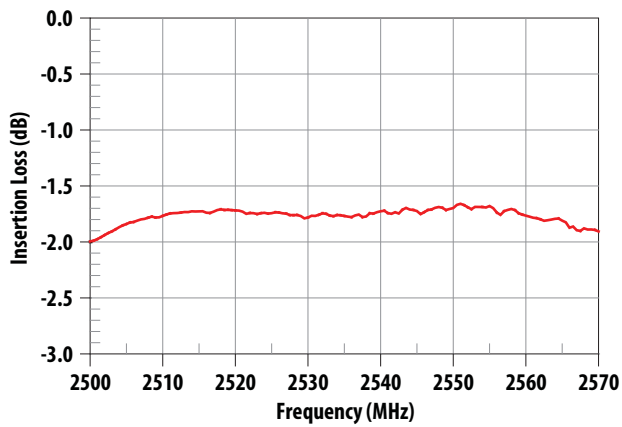

Figure 1. Tx-Ant Insertion Loss.

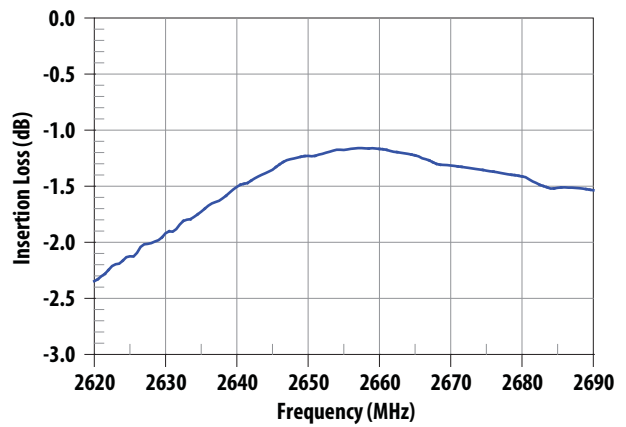

Figure 2. Ant-Rx Insertion Loss.

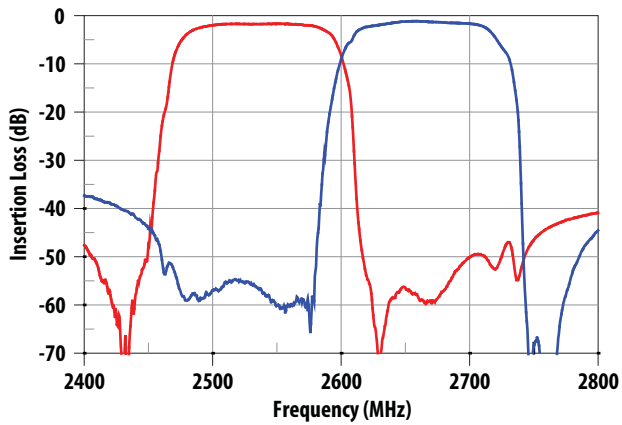

Figure 3. Tx Rejection in Rx Band and Rx Rejection in Tx Band.

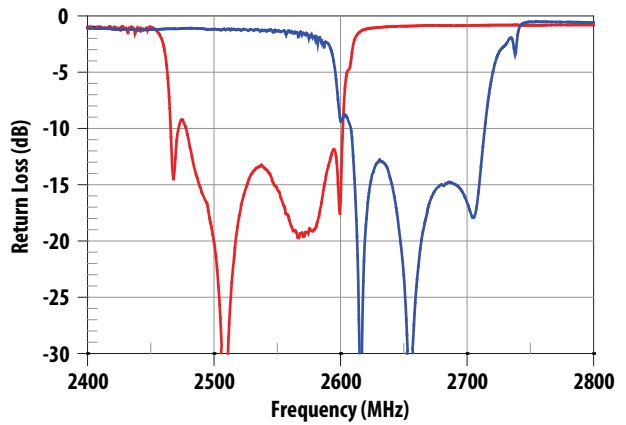

Figure 4. Tx and Rx Port Return Loss.

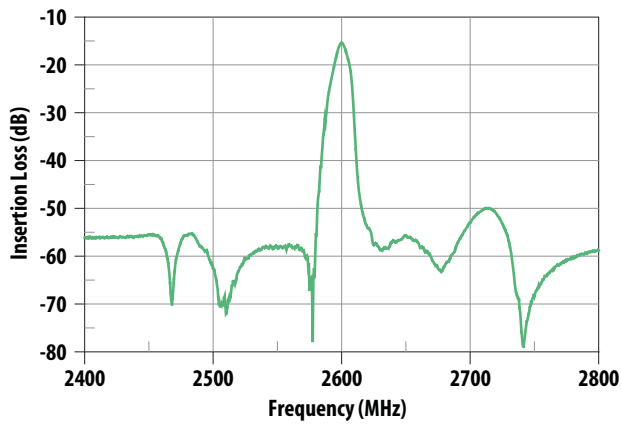

Figure 5. Tx-Rx Isolation.

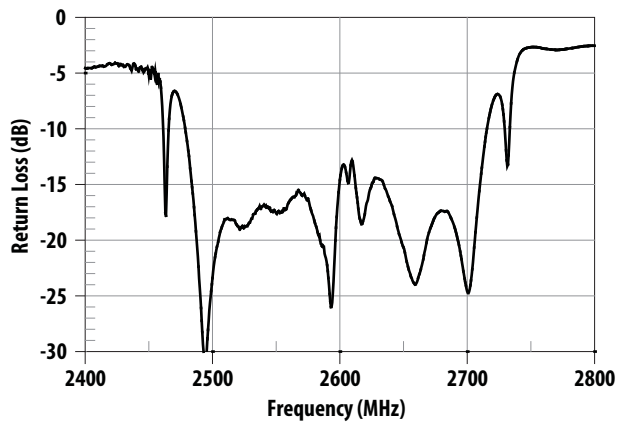

Figure 6. Antenna Port Return Loss.

**ACMD-6007 Typical Performance at  $T_c = 25^\circ\text{C}$**

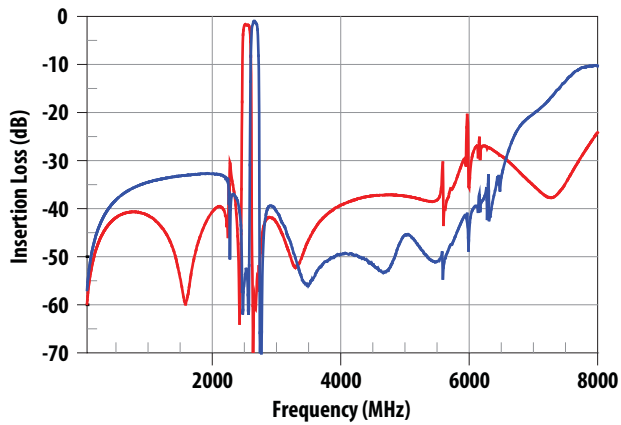

Figure 7. Tx-Ant and Ant-Rx Wideband Insertion Loss.

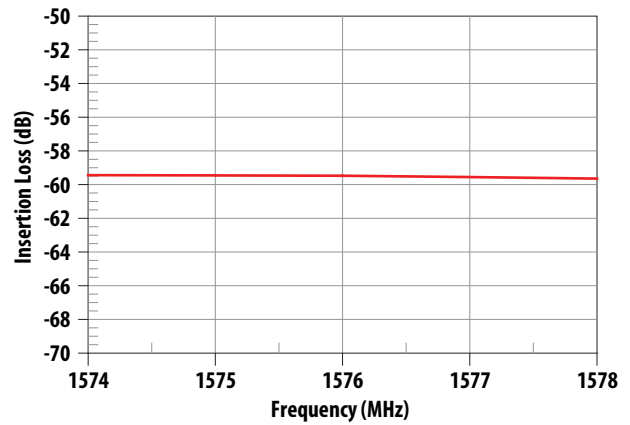

Figure 8. Tx-Ant Rejection in GPS Band.

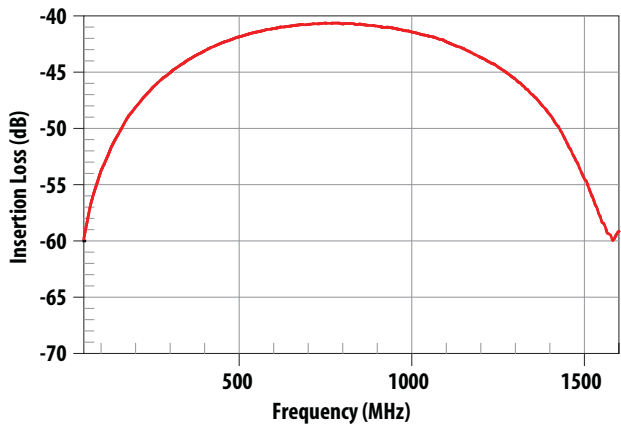

Figure 9. Tx-Ant Low Frequency Rejection, 50 - 1574 MHz.

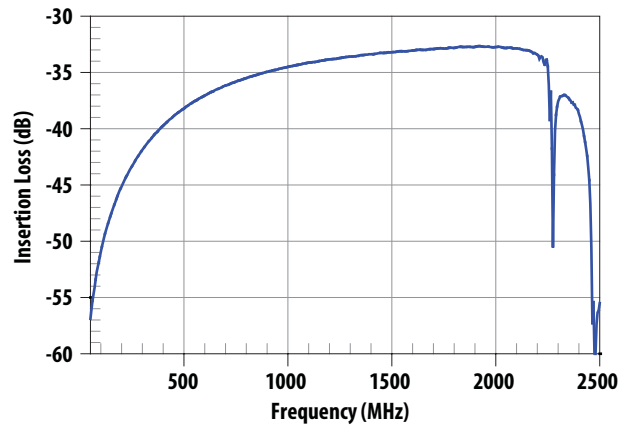

Figure 10. Ant-Rx Low Frequency Rejection, 50 - 2500 MHz.

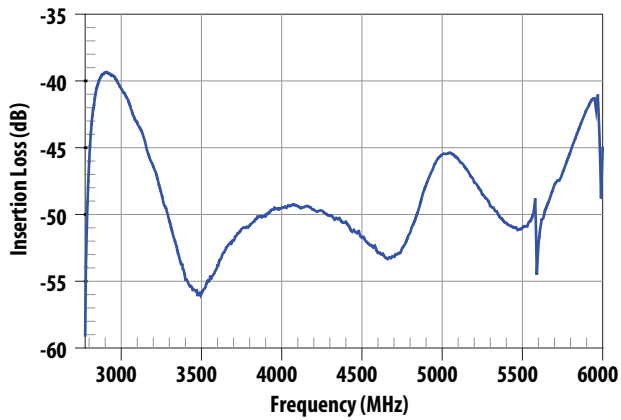

Figure 11. Ant-Rx Rejection, 2775 - 6000.

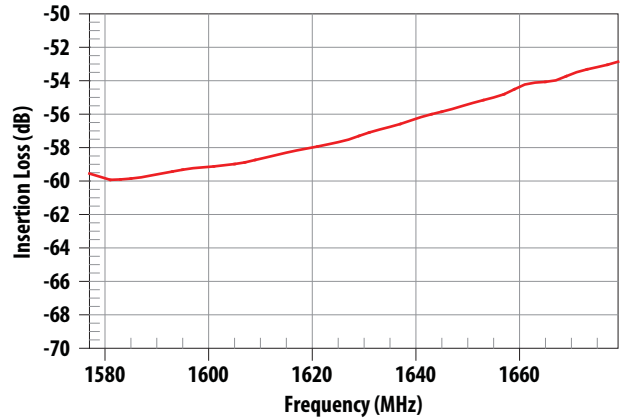

Figure 12. Tx-Ant Low Frequency Rejection, 1577 - 1680 MHz.

**ACMD-6007 Typical Performance at  $T_c = 25^\circ\text{C}$**

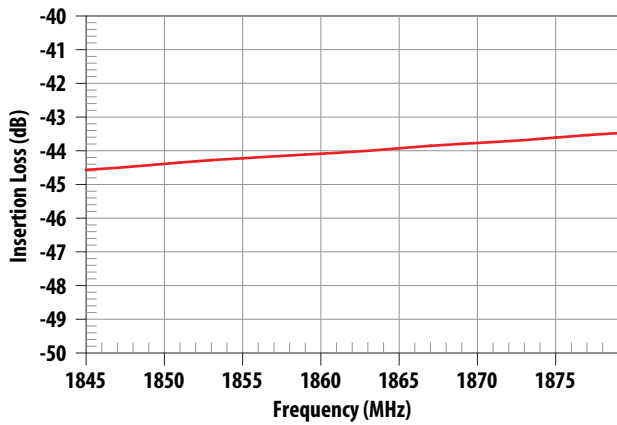

Figure 13. Tx-Ant Low Frequency Rejection, 1845 – 1880 MHz.

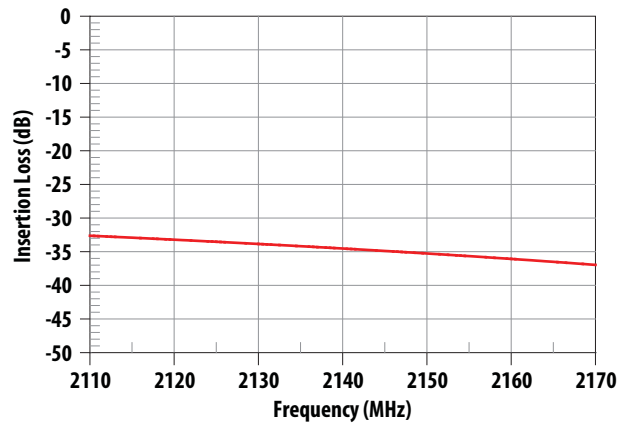

Figure 14. Tx-Ant Low Frequency Rejection, 2110 – 2170 MHz.

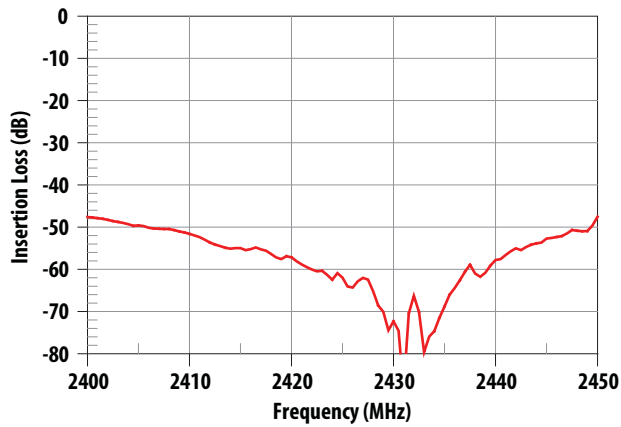

Figure 15. Tx-Ant Low Frequency Rejection, 2400 – 2450 MHz.

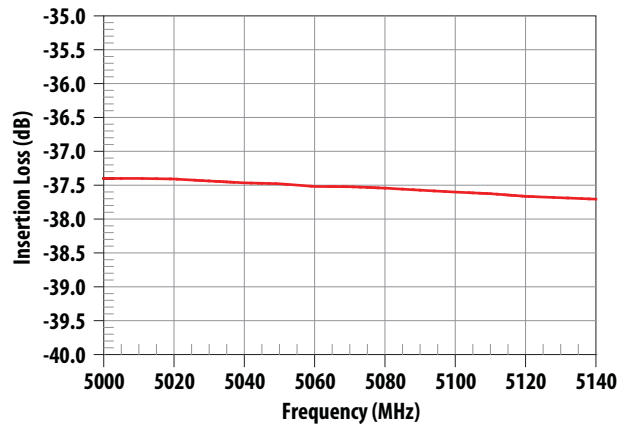

Figure 16. Tx-Ant Low Frequency Rejection at Tx 2<sup>nd</sup> Harmonic, 5000 – 5140 MHz.

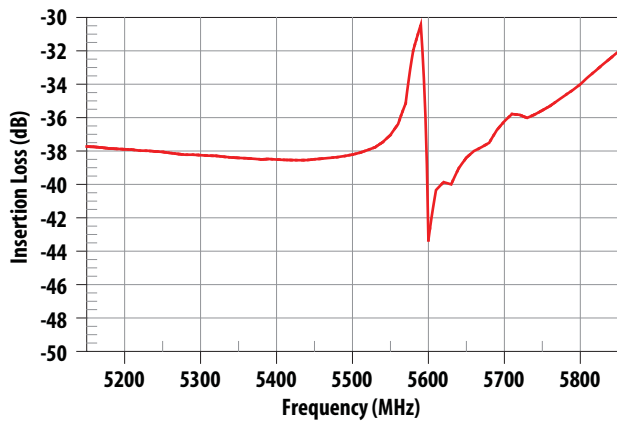

Figure 17. Tx-Ant Low Frequency Rejection, 5150 – 5850 MHz.

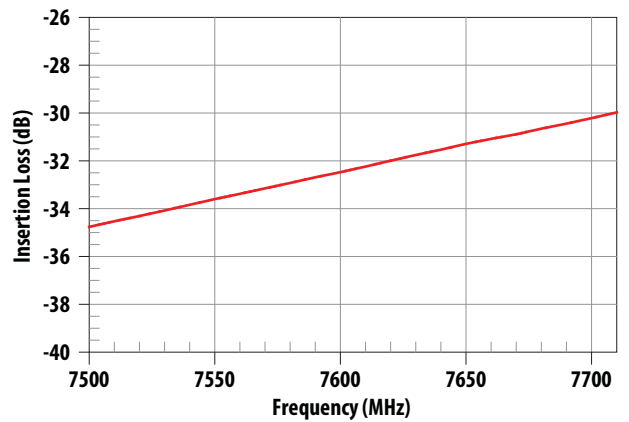

Figure 18. Tx-Ant Low Frequency Rejection, 7500 – 7710 MHz.

# ACMD-6007 Typical Performance at $T_c = 25^\circ\text{C}$

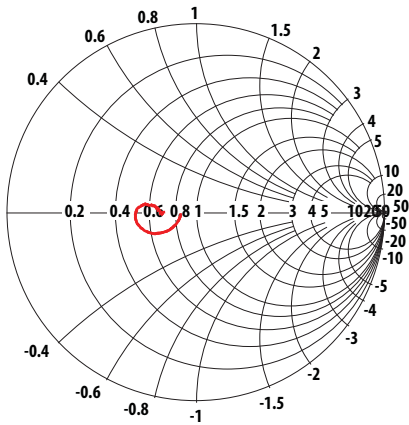

Figure 19. Tx Port Impedance in Tx Band.

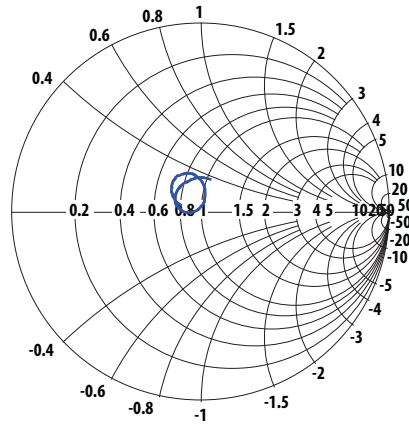

Figure 20. Rx Port Impedance in Rx Band.

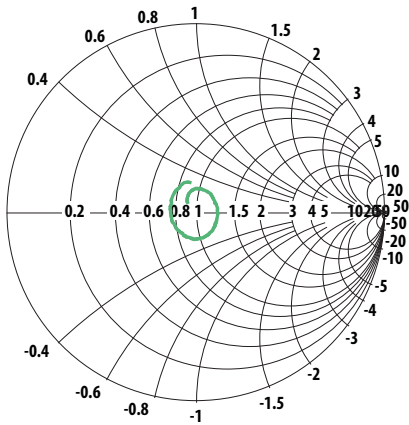

Figure 21. Ant Port Impedance in Tx Band.

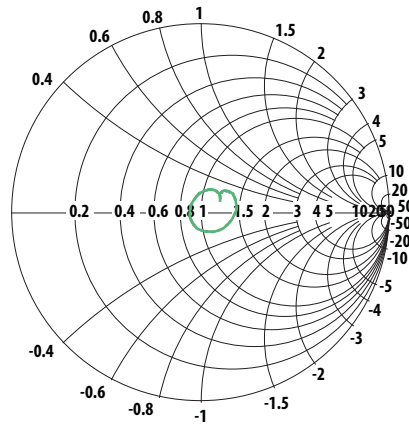
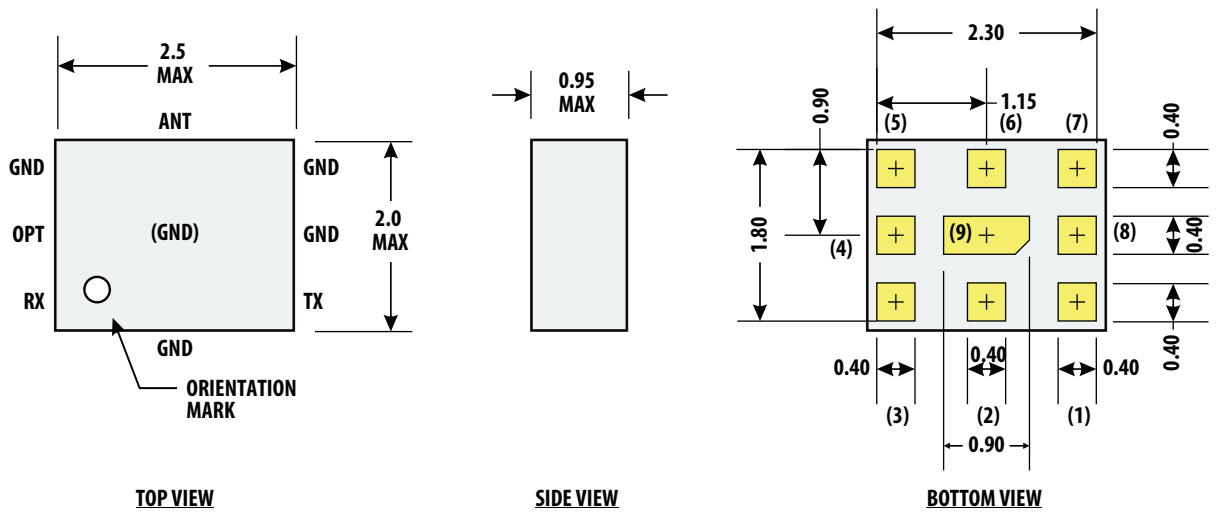

Figure 22. Ant Port Impedance in Rx Band.

# ACMD-6007



**Notes:**

1. Dimensions in millimeters  
Tolerance: X.X ± 0.1 mm  
X.XX ± 0.05 mm
2. Dimensions nominal unless otherwise noted
3. Angles 45° nominal
4. I/O Pads (3 ea)  
Size: 0.40 X 0.40 mm  
Spacing to ground metal: 0.30 mm
5. Contact areas are gold plated

**Pin Connections:**

- |               |                            |
|---------------|----------------------------|
| 1             | Rx                         |
| 2, 4, 5, 7, 9 | Gnd                        |
| 3             | Tx                         |
| 6             | Ant                        |
| 8             | Optional: Gnd, NC or Rx(-) |

**Figure 23. Package Outline Drawing.**

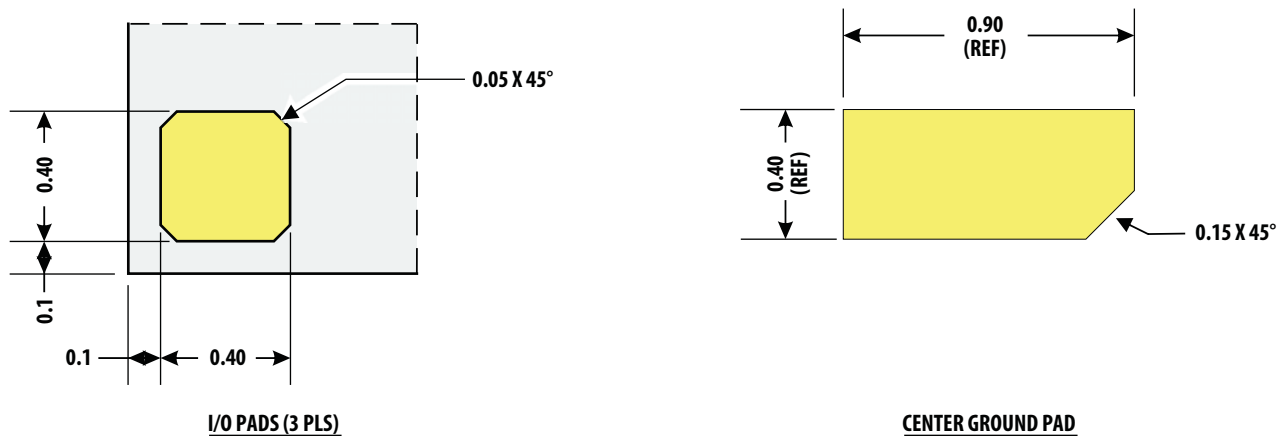
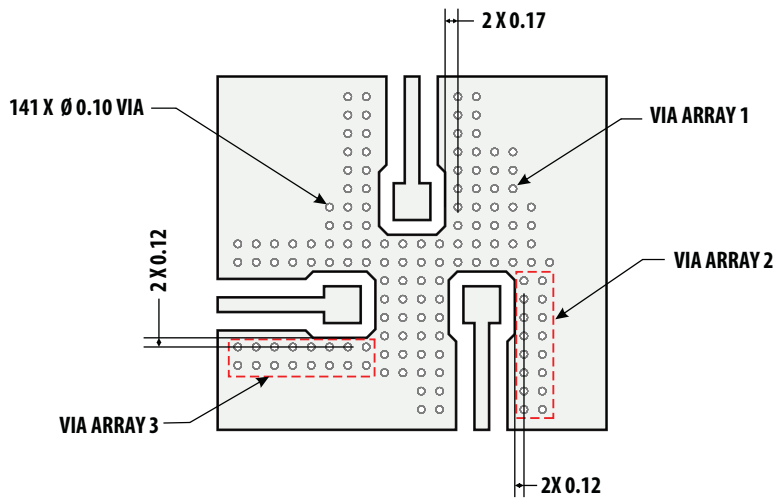

**Figure 24. Pad Detail.**





**ACMD-6007**



- Notes:
1. Dimensions in mm
  2. Top view
  3. Via arrays: horiz pitch = 0.25, vert pitch = 0.25

**Figure 26. PCB Layout, Via Detail.**

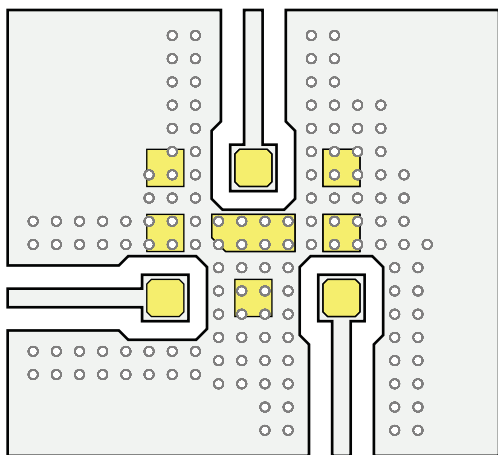

- Note:
1. Top view

**Figure 27. ACMD-6007 Superposed on PCB Layout.**

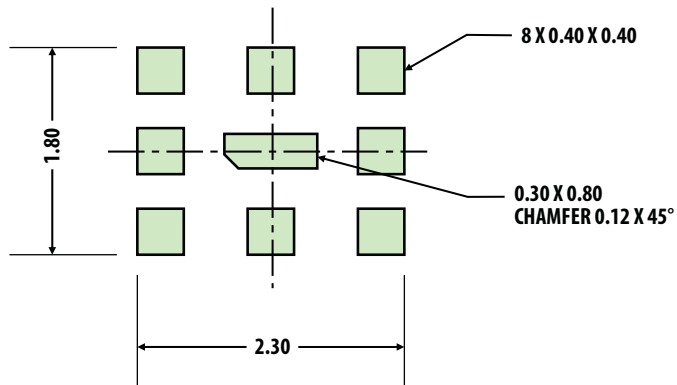

- Notes:
1. Dimensions in mm
  2. Top view
  3. Chamfer or radius all corners 0.05 mm min

**Figure 28. Recommended Solder Stencil.**

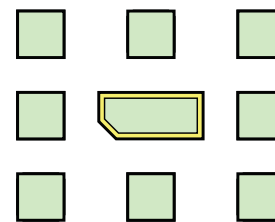

- Notes:
1. Top view
  2. Peripheral clearance of stencil aperture for center device pad is 0.05 mm. All other apertures match device pad 1:1

**Figure 29. Solder Stencil Superposed on ACMD-6007.**

**ACMD-6007**

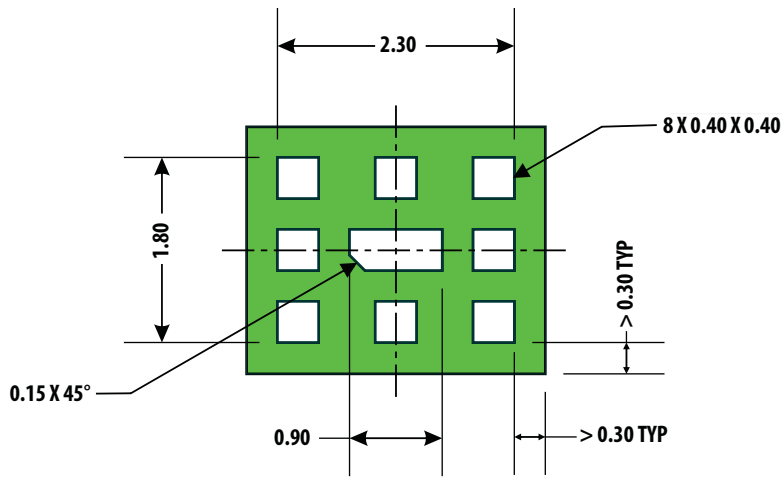

- Notes:
1. Dimensions in mm
  2. Top view

**Figure 30. Recommended Solder Mask.**

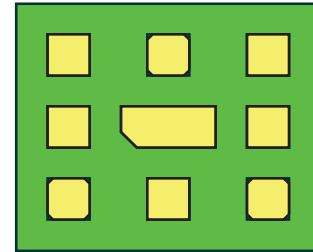

- Notes:
1. Top view
  2. Mask apertures match device pads 1:1

**Figure 31. Solder Mask Superposed on ACMD-6007.**

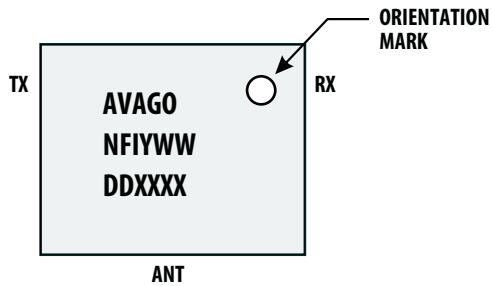

- AVAGO = Mfg (Avago Technologies, Inc.)
- N = ACMD-6007
- FI = Mfg Information
- Y = Year
- WW = Work Week
- DD = Date Code
- XXXX = Assembly Lot

**Figure 32. Product Marking and Pin Orientation.**

**ACMD-6007**

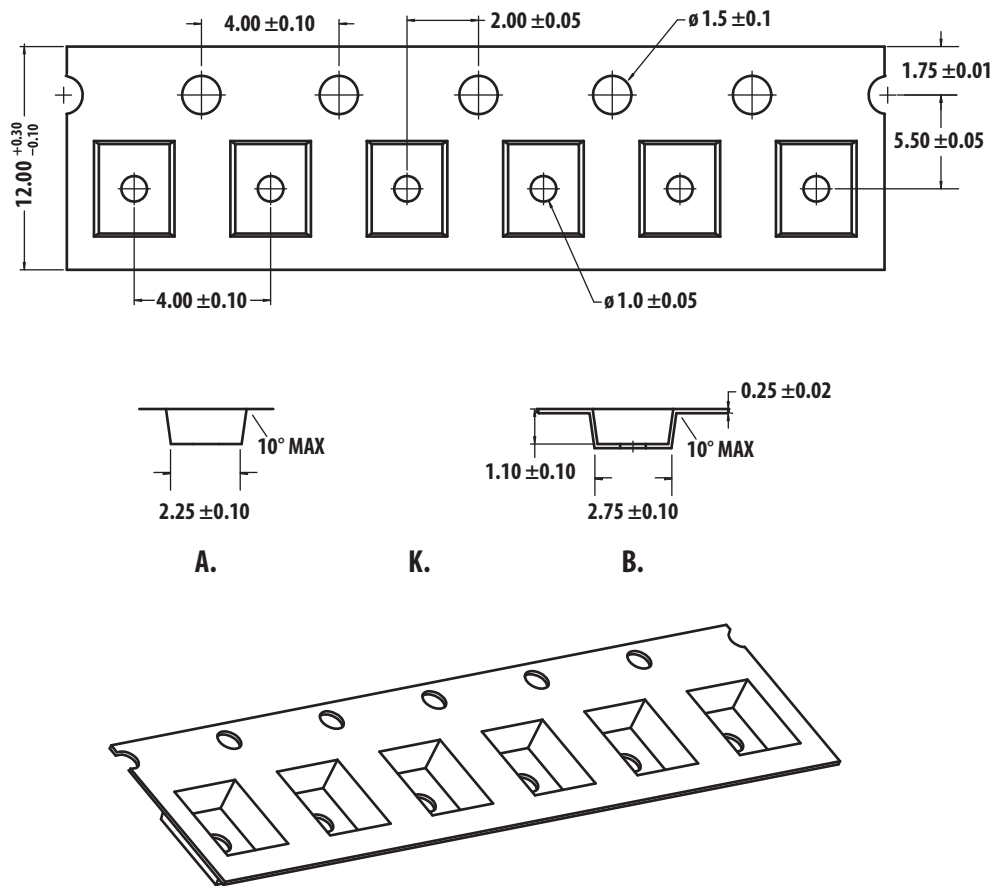

**Figure 33. SMD Tape Packing.**

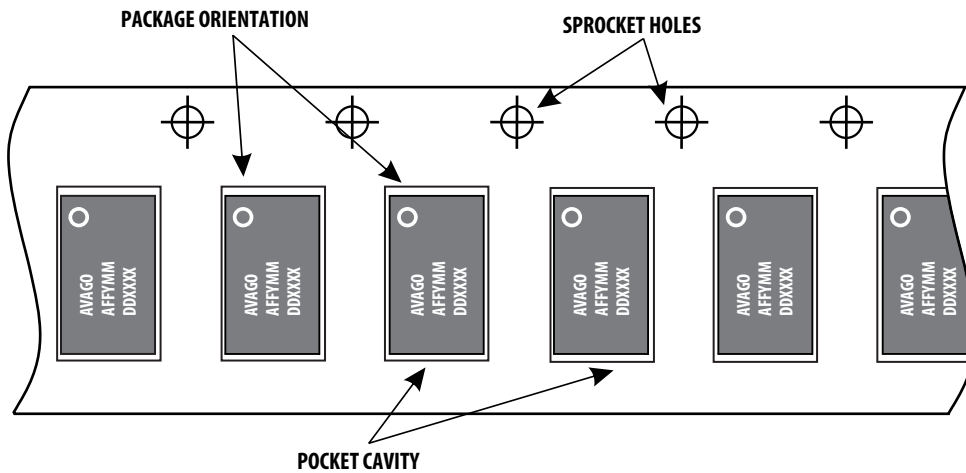

**Figure 34. Unit Orientation in SMT Tape.**

**ACMD-6007**

**FRONT VIEW**

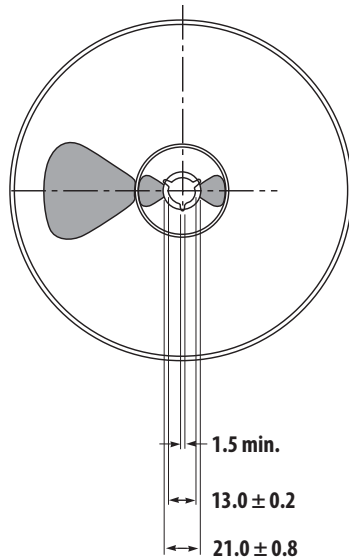

**NOTES:**

1. Reel shall be labeled with the following information (as a minimum).
  - a. manufacturer's name or symbol
  - b. Avago Technologies part number
  - c. purchase order number
  - d. date code
  - e. quantity of units
2. A certificate of compliance (c of c) shall be issued and accompany each shipment of product.
3. Reel must not be made with or contain ozone depleting materials.
4. All dimensions in millimeters (mm)

**BACK VIEW**

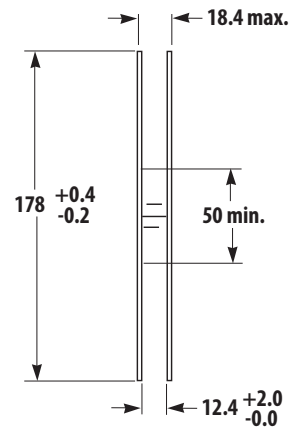
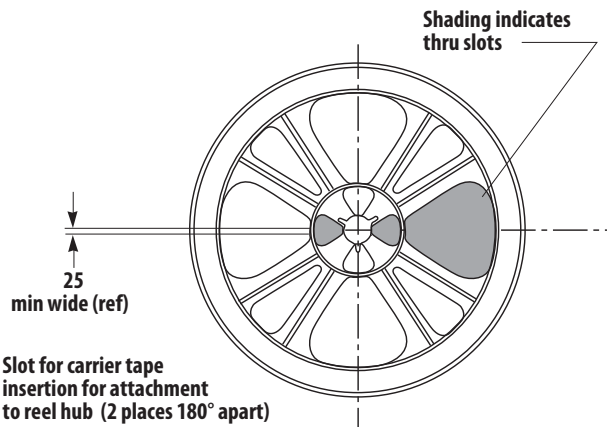

**Figure 35. SMT Reel Drawing.**

## Package Moisture Sensitivity

Feature	Test Method	Performance
Moisture Sensitivity Level (MSL) at 260°C	JESD22-A113D	Level 3

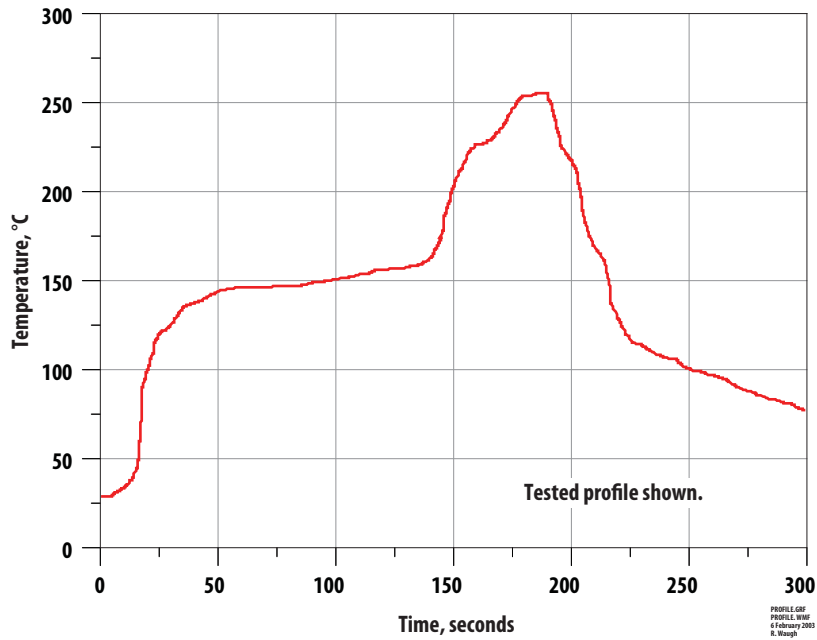

Figure 36. Verified SMT Solder Profile.

## Ordering Information

Part Number	No. of Devices	Container
ACMD-6007-BLK	100	Anti-static Bag
ACMD-6007-TR1	3000	178 mm (7-inch Reel)

For product information and a complete list of distributors, please go to our web site: [www.avagotech.com](http://www.avagotech.com)

Avago, Avago Technologies, and the A logo are trademarks of Avago Technologies in the United States and other countries. Data subject to change. Copyright © 2005-2010 Avago Technologies. All rights reserved.  
AV02-2568EN - July 5, 2010

**AVAGO**  
TECHNOLOGIES