

ACMD-7407

UMTS Band 2 Duplexer



Data Sheet



Description

The Avago ACMD-7407 is a highly miniaturized duplexer designed for use in UMTS Band 2 (1850.48 – 1909.52 MHz UL, 1930.48 – 1989.52 MHz DL) handsets and mobile data terminals.

Low Insertion Loss in the Tx channel minimizes current drain from the power amplifier, while low Rx channel Insertion Loss improves receiver sensitivity.

The ACMD-7407 enhances the sensitivity and dynamic range of handset receivers by providing high isolation of the transmitted signal from the receiver input and high rejection of transmit-generated noise in the receive band.

The ACMD-7407 is designed with Avago Technologies' innovative Film Bulk Acoustic Resonator (FBAR) technology, which makes possible ultra-small, high-Q filters at a fraction of their usual size. The excellent power handling capability of FBAR bulk-mode resonators supports the high output power levels used in mobile communications applications, while adding virtually no distortion.

The ACMD-7407 also utilizes Avago Technologies' advanced Microcap bonded-wafer, chip scale packaging technology. This process allows the filters to be assembled into a molded chip-on-board module with an overall size of only 2.0 x 2.5 mm and maximum height of 0.90 mm. The ACMD-7407 is compatible with standard 2.0 x 2.5 mm duplexer PCB footprints.

Functional Block Diagram

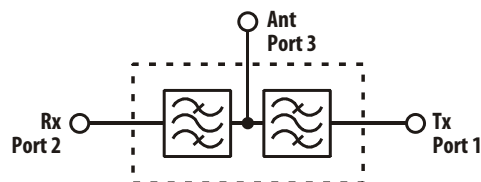

Features

- High Isolation
- Miniature Size
 - 2.0 x 2.5 mm size
 - 0.90 mm Max Height
 - Standard 2 x 2.5 mm PCB footprint
- High Power Rating
 - 33 dBm Abs Max Tx Power
- Environmental
 - RoHS Compliant
 - Halogen free
 - TBBPA Free

Specifications

- Rx Band Performance, –20 to +85°C
 - Insertion Loss: 3.2 dB Max
 - Rx Noise Blocking: 47 dB Min
- Tx Band Performance, –20 to +85°C
 - Insertion Loss: 2.8 dB Max
 - Tx Interferer Blocking: 55 dB Min

Applications

UMTS / W-CDMA or N-CDMA Handsets or data terminals operating in the Band 2 frequency range.

ACMD-7407 Electrical Specifications ^[2], $Z_0=50\ \Omega$, T_C ^[1] as indicated

Symbol	Parameter	Units	- 20°C			+25°C			+85°C		
			Min	Typ ^[3]	Max	Min	Typ ^[3]	Max	Min	Typ ^[3]	Max
Antenna Port to Receive Port											
S23	Insertion Loss in Receive Band ^[4] (1930.48 – 1989.52 MHz)	dB			3.2		1.6	3.0			3.2
S22	Return Loss (SWR) of Receive Port in Receive Band (1930.48 – 1989.52 MHz)	dB	9		(2.1)	9	16 (1.3)	(2.1)	9		(2.1)
S23	Attenuation in Transmit Band (1850.48 – 1909.52 MHz)	dB	52			52	61		52		
S23	Attenuation, 0 – 1600 MHz	dB	33			33	45		33		
S23	Attenuation, 1770 – 1830 MHz	dB	33			33	45		33		
S23	Attenuation in Bluetooth Band (2400 – 2483.5 MHz)	dB	35			35	46		35		
S23	Attenuation, 3780 – 3900 MHz	dB	35			35	59		35		
S23	Attenuation, 5630 – 5810 MHz	dB	30			30	38		30		
Transmit Port to Antenna Port											
S31	Insertion Loss in Transmit Band ^[4] (1850.48 – 1909.52 MHz)	dB			2.8		1.4	2.5			2.8 ^[5]
S11	Return Loss (SWR) of Transmit Port in Transmit Band (1850.48 – 1909.52 MHz)	dB	9		(2.1)	9	15 (1.4)	(2.1)	9		(2.1)
S31	Attenuation in Receive Band (1930.48 – 1989.52 MHz)	dB	44			44	52		44		
S31	Attenuation, 0 – 1600 MHz	dB	30			30	42		30		
S31	Attenuation in GPS Rx Band (1574.42 – 1576.42 MHz)	dB	30			30	37		30		
S31	Attenuation, 2110 – 2170 MHz	dB	30			30	39		30		
S31	Attenuation in Bluetooth Band (2400 – 2483.5 MHz)	dB	40			40	49		40		
S31	Attenuation in Transmit 2 nd Harmonic Band (3700 – 3820 MHz)	dB	20			20	39		20		
S31	Attenuation in Transmit 3 rd Harmonic Band (5550 – 5730 MHz)	dB	10			10	17		10		

ACMD-7407 Electrical Specifications ^[2], $Z_0=50\ \Omega$, T_C ^[1] as indicated

Symbol	Parameter	Units	- 20°C			+25°C			+85°C		
			Min	Typ ^[3]	Max	Min	Typ ^[3]	Max	Min	Typ ^[3]	Max
Antenna Port											
S33	Return Loss (SWR) of Ant Port in Rx Band (1930.48 – 1989.52 MHz)	dB	9		(2.1)	9	18 (1.3)	(2.1)	9		(2.1)
S33	Return Loss (SWR) of Ant Port in Tx Band (1850.48 – 1909.52 MHz)	dB	9		(2.1)	9	16 (1.3)	(2.1)	9		(2.1)
Isolation Transmit Port to Receive Port											
S21	Tx-Rx Isolation in Receive Band [4] (1930.48 – 1989.52 MHz)	dB	47			47	56		47		
S21	Tx-Rx Isolation in Transmit Band ^[4] (1850.48 – 1909.52 MHz)	dB	55			55	58		55		

Notes:

- T_C is the case temperature and is defined as the temperature of the underside of the Duplexer where it makes contact with the circuit board.
- Min/Max specifications are guaranteed at the indicated temperature with the input power to the Tx port equal to or less than +29 dBm over all Tx frequencies unless otherwise noted.
- Typical data is the average value of the parameter over the indicated band at the specified temperature. Typical values may vary over time.
- Integrated Insertion Loss over any 3.84 MHz channel within the band.
- The maximum Tx Insertion Loss specification at $T_C = +85^\circ\text{C}$ is guaranteed for input power $\leq +27$ dBm. For Tx input power between +27 dBm and +29 dBm, the Tx Insertion Loss is higher by 0.2 dB. Alternatively, the Tx Insertion Loss specification is compliant to +29 dBm input power for $T_C \leq 79^\circ\text{C}$.

Absolute Maximum Ratings ^[1]

Parameter	Unit	Value
Storage temperature	°C	-65 to +125
Maximum RF Input Power to Tx Port	dBm	+33

Maximum Recommended Operating Conditions ^[2]

Parameter	Unit	Value
Operating temperature, T_C ^[3] , Tx Power ≤ 29 dBm, CW	°C	-40 to +100
Operating temperature, T_C ^[3] , Tx Power ≤ 30 dBm, CW	°C	-40 to +85

Notes:

- Operation in excess of any one of these conditions may result in permanent damage to the device.
- The device will function over the recommended range without degradation in reliability or permanent change in performance, but is not guaranteed to meet electrical specifications.
- T_C is defined as case temperature, the temperature of the underside of the duplexer where it makes contact with the circuit board.

ACMD-7407 Typical Performance at $T_c = 25^\circ\text{C}$

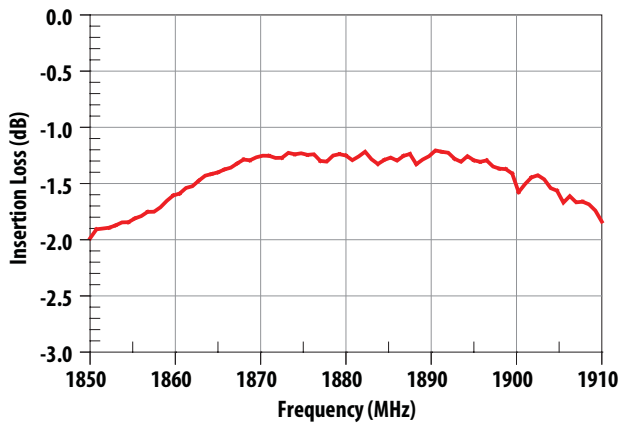

Figure 1. Tx-Ant Insertion Loss.

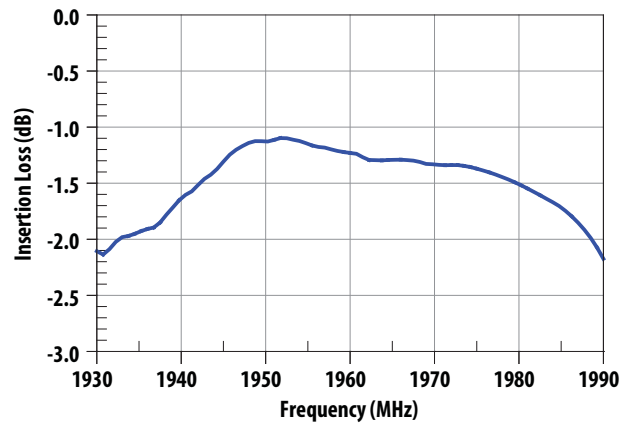

Figure 2. Ant-Rx Insertion Loss.

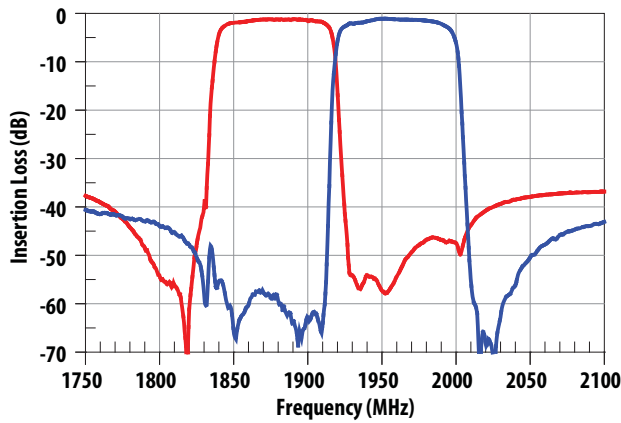

Figure 3. Tx Rejection in Rx Band and Rx Rejection in Tx Band.

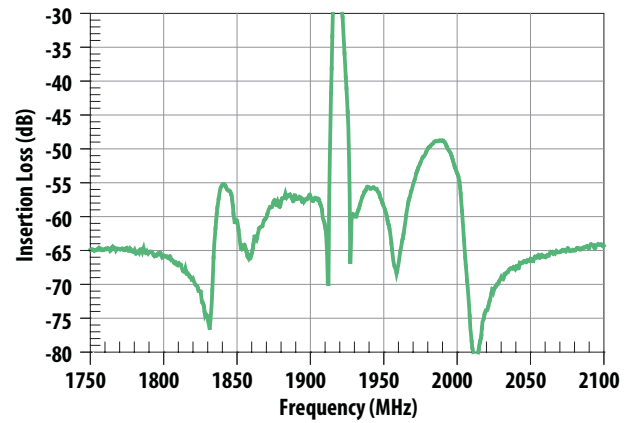

Figure 4. Tx-Rx Isolation.

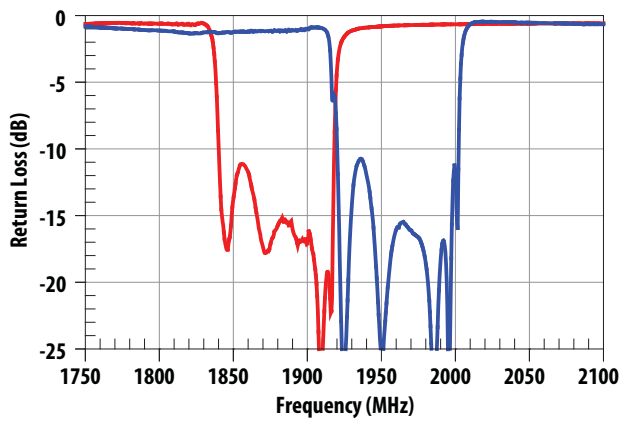

Figure 5. Tx and Rx Port Return Loss.

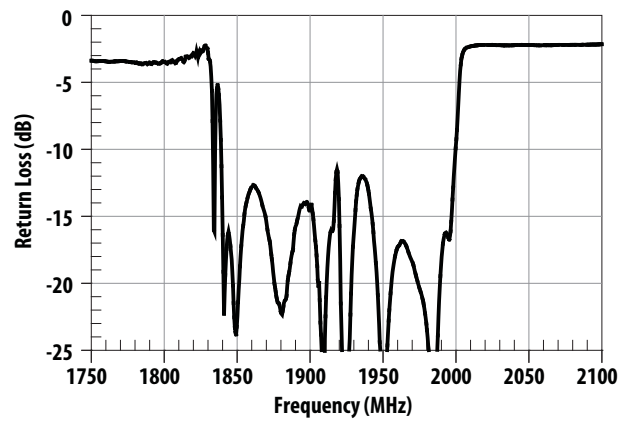

Figure 6. Antenna Port Return Loss.

ACMD-7407 Typical Performance at $T_c = 25^\circ\text{C}$

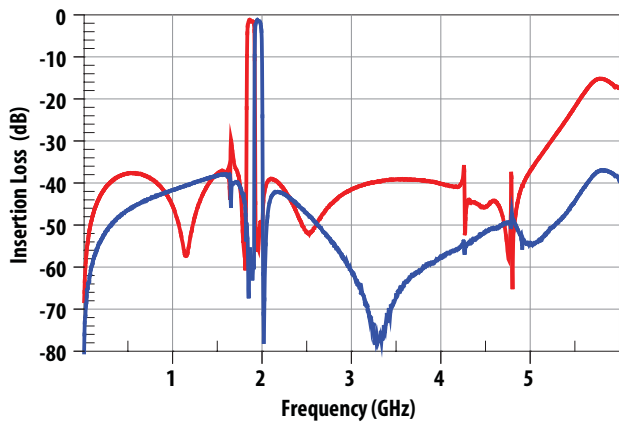

Figure 7. Tx-Ant and Ant-Rx Wideband Insertion Loss.

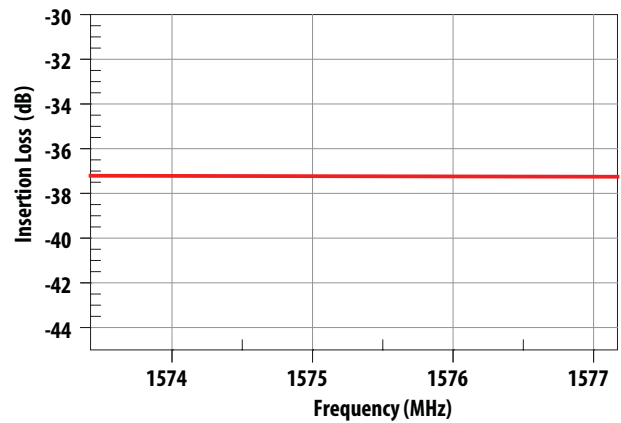

Figure 8. Tx-Ant Rejection in GPS Band.

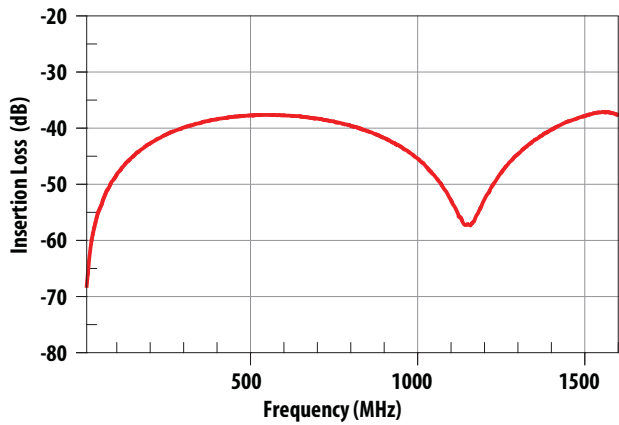

Figure 9. Tx-Ant Low Frequency Rejection.

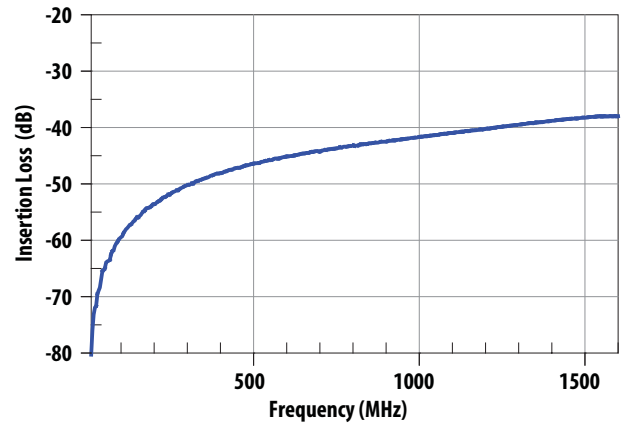

Figure 10. Ant-Rx Low Frequency Rejection.

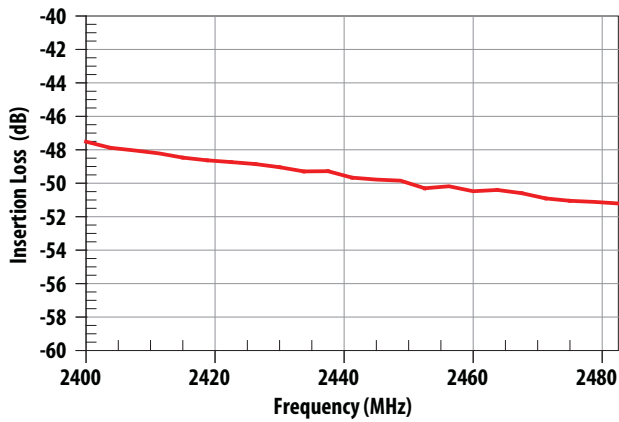

Figure 11. Tx-Ant Rejection in Bluetooth Band.

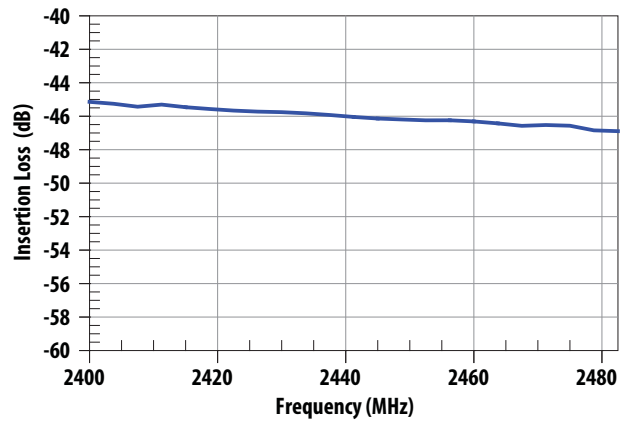

Figure 12. Ant-Rx Rejection in Bluetooth Band.

ACMD-7407 Typical Performance at $T_c = 25^\circ\text{C}$

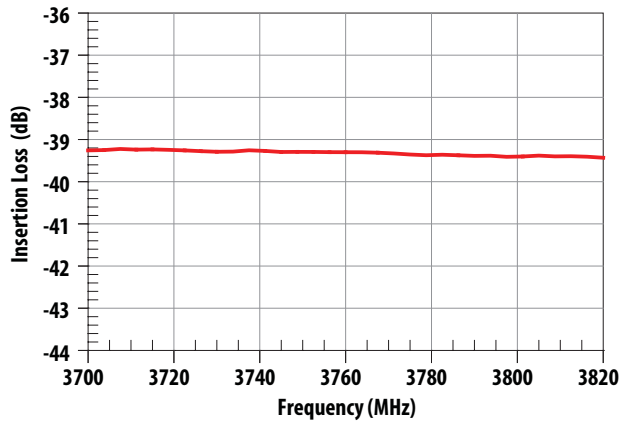

Figure 13. Tx-Ant Rejection at Tx Second Harmonic.

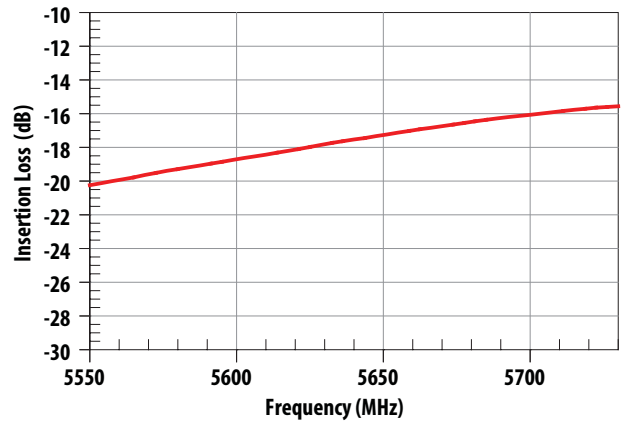

Figure 14. Tx-Ant Rejection at Tx Third Harmonic.

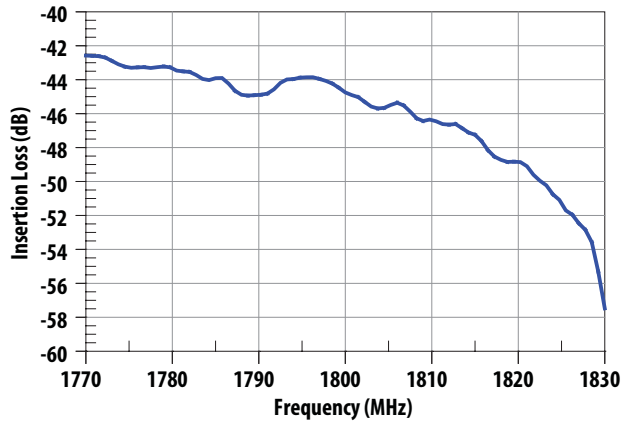

Figure 15. Ant-Rx Rejection, 1770-1830 MHz.

ACMD-7407 Typical Performance at $T_c = 25^\circ\text{C}$

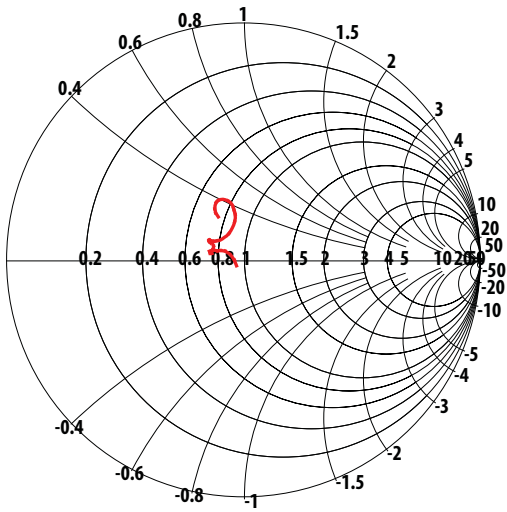

Figure 16. Tx Port Impedance in Tx Band.

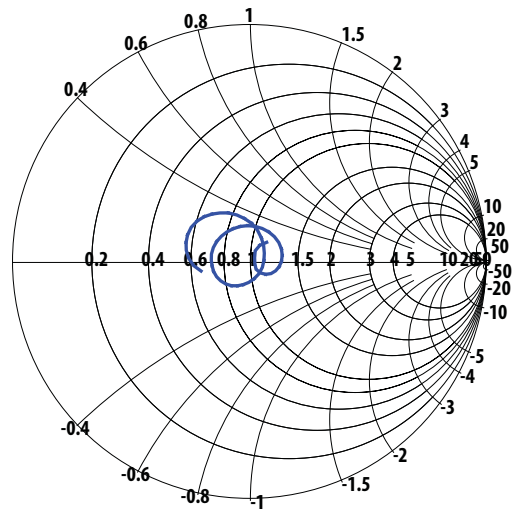

Figure 17. Rx Port Impedance in Rx Band.

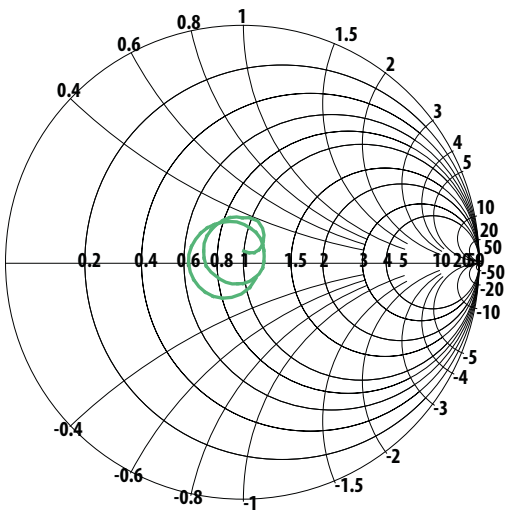

Figure 18. Ant Port Impedance in Tx Band.

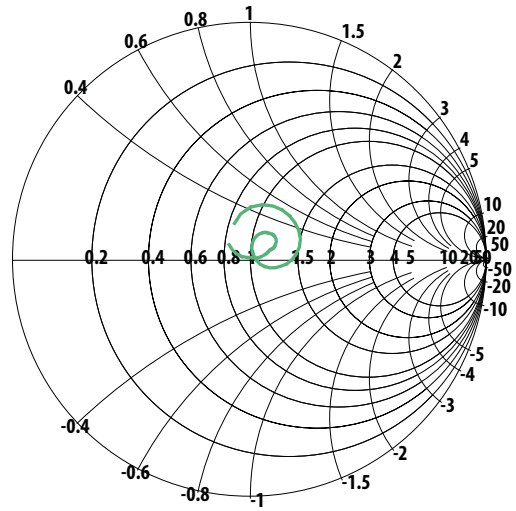
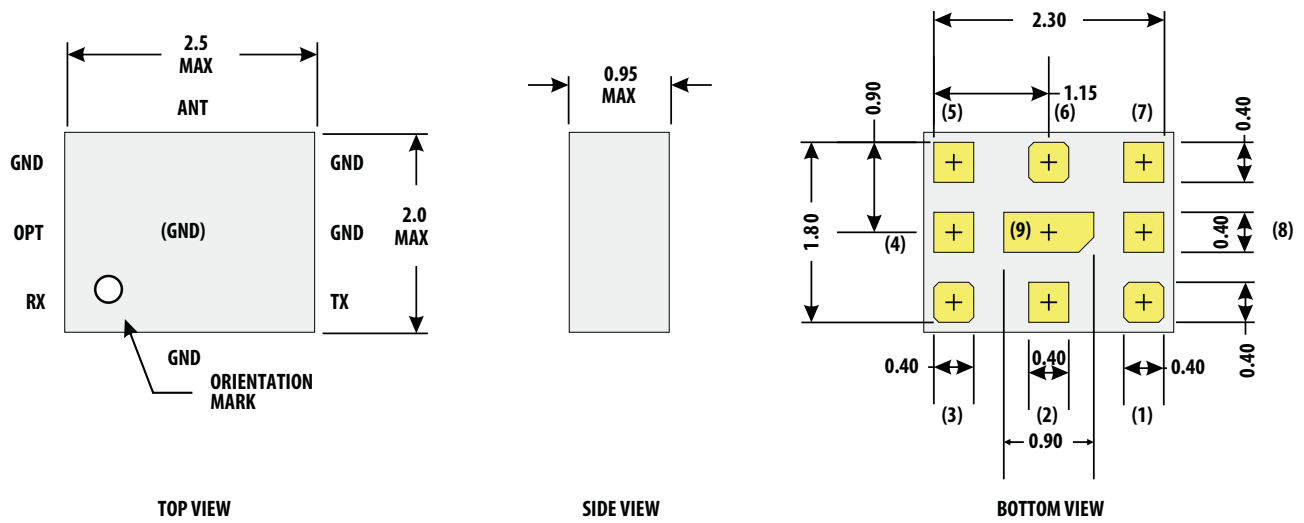

Figure 19. Ant Port Impedance in Rx Band.



Notes:

1. Dimensions in millimeters
Tolerance: $X.X \pm 0.1$ mm
 $X.XX \pm 0.05$ mm
2. Dimensions nominal unless otherwise noted
3. Angles 45° nominal
4. I/O Pads (3 ea)
Size: 0.40×0.40 mm
Spacing to ground metal: 0.30 mm
5. Contact areas are gold plated

Pin Connections:

- | | |
|---------------|-----------------------------|
| 1 | Rx |
| 2, 4, 5, 7, 9 | Gnd |
| 3 | Tx |
| 6 | Ant |
| 8 | Optional: Gnd, NC, or Rx(-) |

Figure 20. Package Outline Drawing.

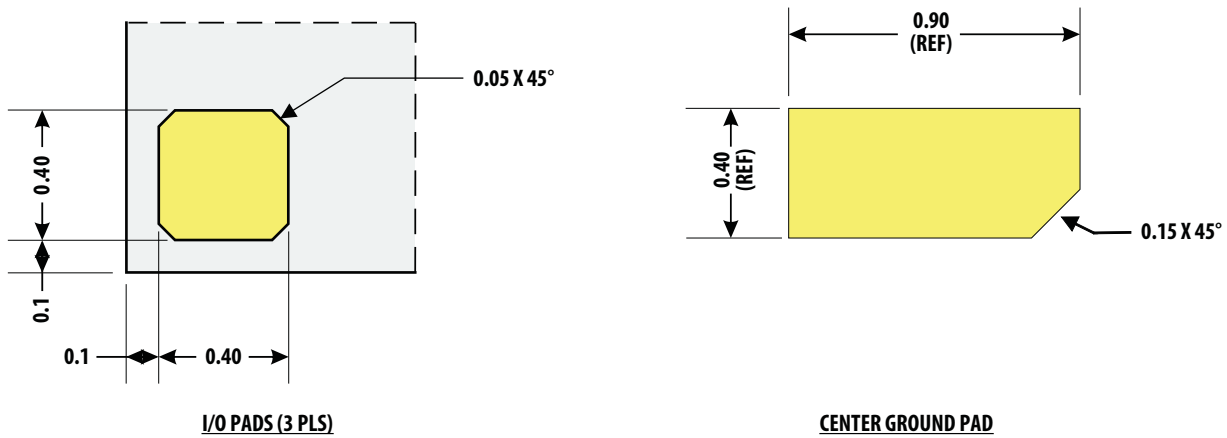

Figure 21. Pad Detail.

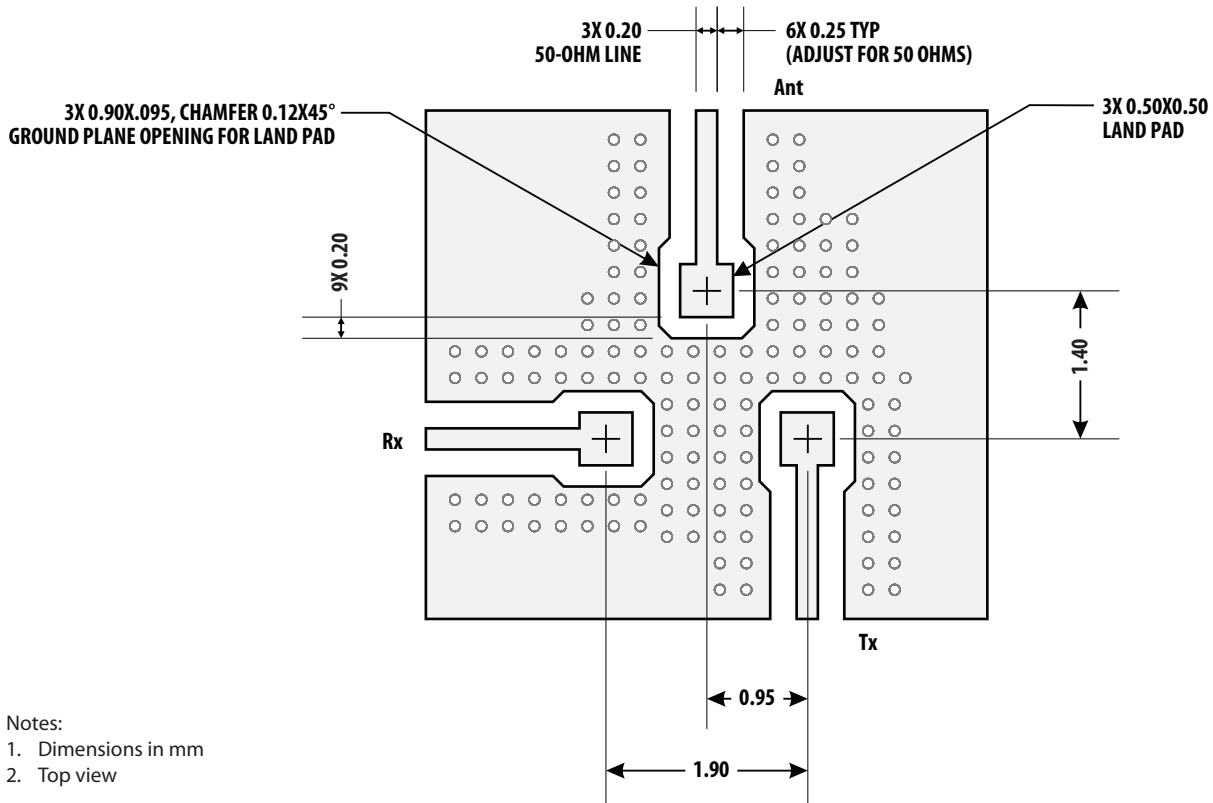

Figure 22. Suggested PCB Layout.

A PCB layout using the principles illustrated in the figure above is recommended to optimize performance of the ACMD-7407.

Note: Pin 8 grounded in this example.

The transmission line dimensions shown are designed to achieve an impedance of 50 ohms for an 80µm thick PCB layer with a dielectric constant of 3.4. If other PCB materials or thicknesses are used, the 0.25 mm gap spacing may need to be adjusted to retain a Z_0 of 50 ohms.

It is important to maximize isolation between the Tx and Rx ports.

High isolation is achieved by: (1) maintaining a continuous ground plane around the I/O connections and duplexer mounting area, and (2) surrounding the I/O ports with sufficient ground vias to enclose the connections in a "Faraday cage."

The ground vias under the ACMD-7407 mounting area are also needed to provide adequate heat sinking for the device.

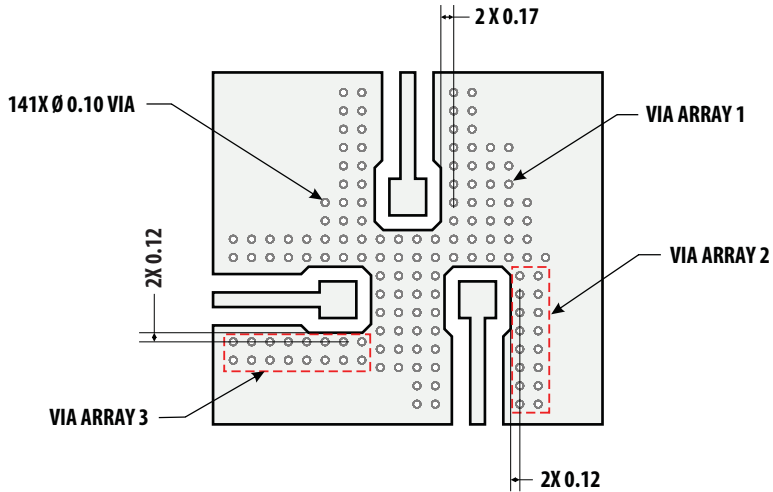

- Notes:
1. Dimensions in mm
 2. Top view
 3. Via arrays: horiz pitch = 0.25, vert pitch = 0.25

Figure 23. PCB Layout, Via Detail.

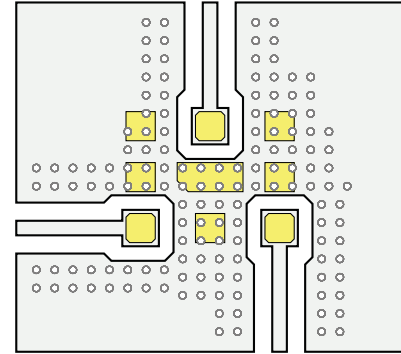

- Notes:
1. Top view

Figure 24. ACMD-7407 Superposed on PCB Layout.

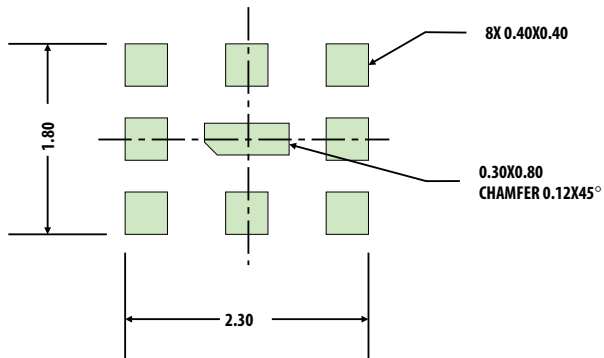

- Notes:
1. Dimensions in mm
 2. Top view
 3. Chamfer or radius all corners 0.05 mm min

Figure 25. Recommended Solder Stencil.

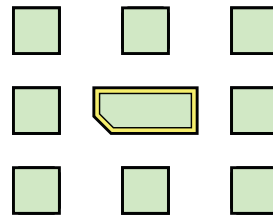

- Notes:
1. Top view
 2. Peripheral clearance of stencil aperture for center device pad is 0.05 mm. All other apertures match device pad 1:1

Figure 26. Solder Stencil Superposed on ACMD-7407.

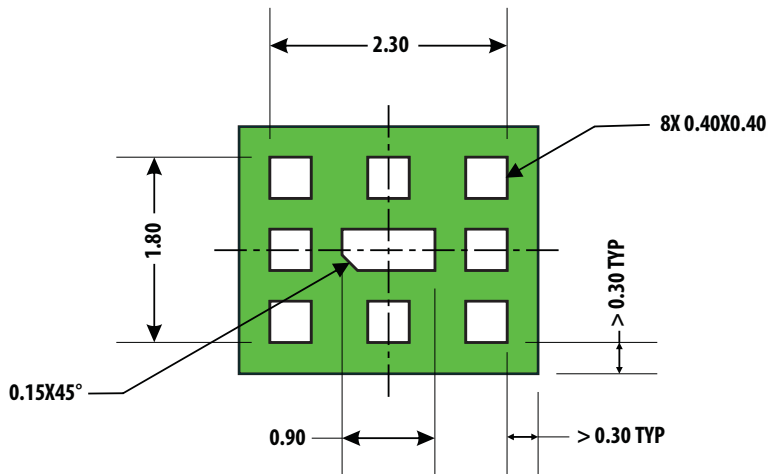

- Notes:
1. Dimensions in mm
 2. Top view

Figure 27. Recommended Solder Mask.

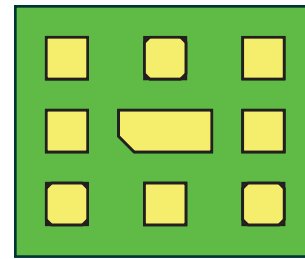

- Notes:
1. Top view
 2. Mask apertures match device pads 1:1

Figure 28. Solder Mask Superposed on ACMD-7407.

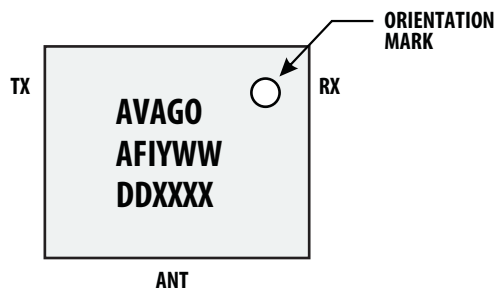

- A = ACMD-7407
- FI = Mfg Information
- Y = Year
- WW = Work Week
- DD = Date Code
- XXXX = Assembly Lot

Figure 29. Product Marking and Pin Orientation.

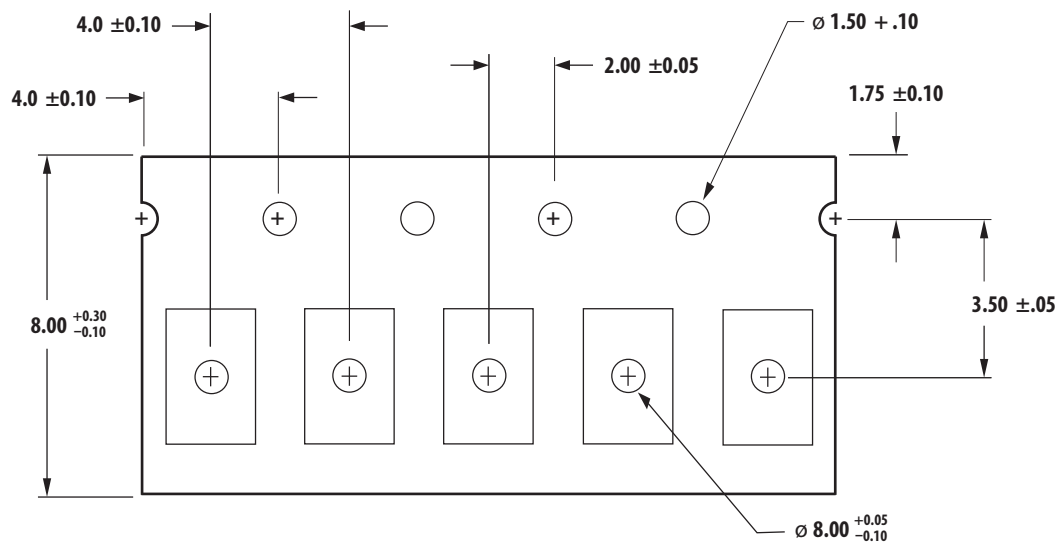

Figure 30. SMD Tape Packing.

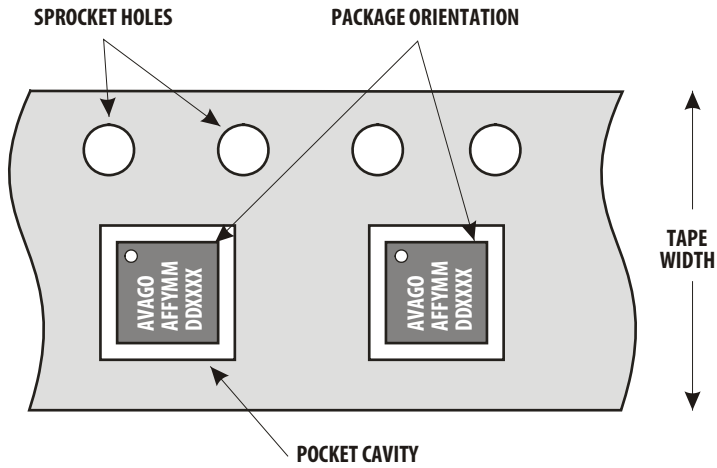

Figure 31. Unit Orientation in SMT Tape.

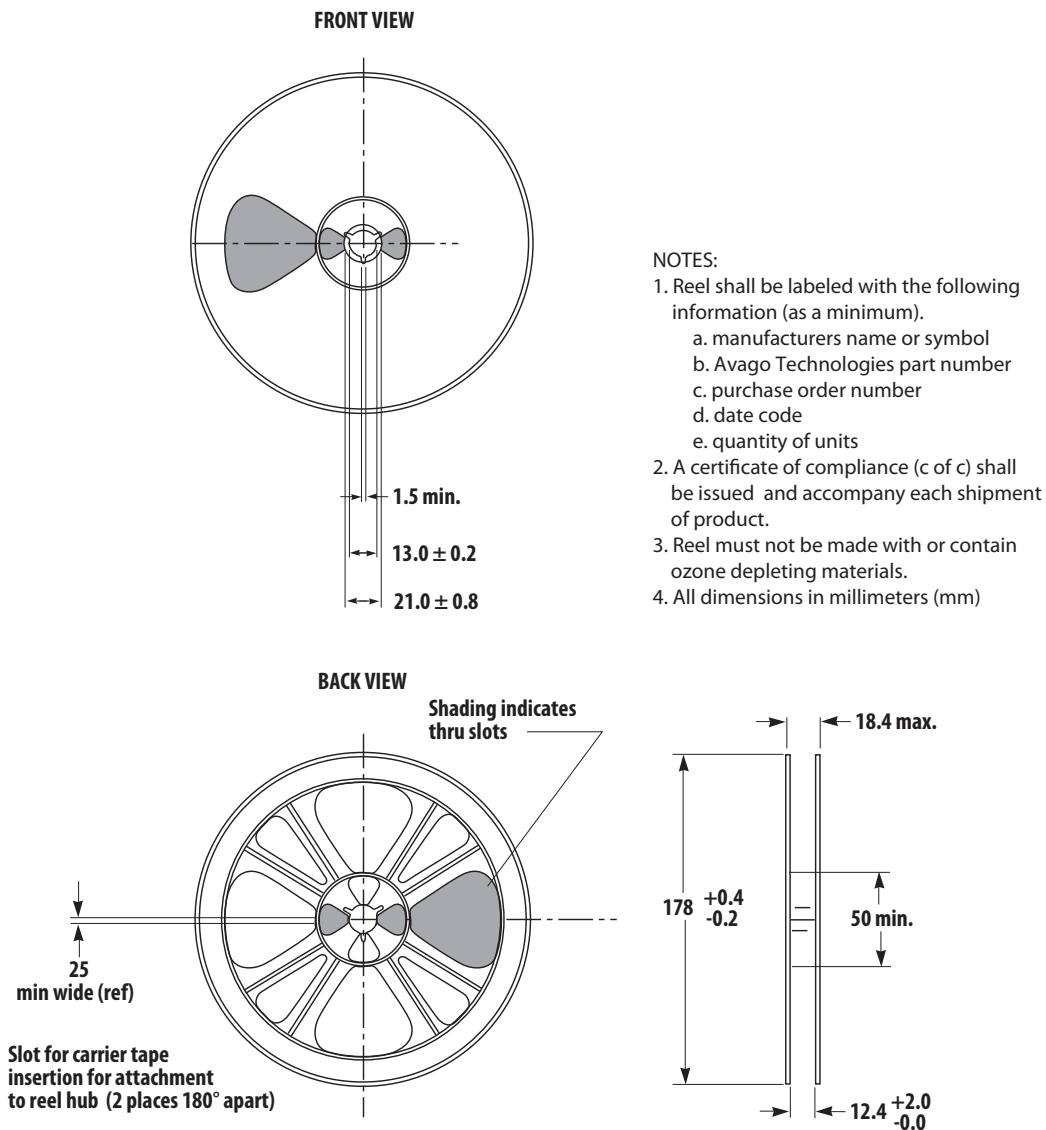

Figure 32. SMT Reel Drawing.

Package Moisture Sensitivity

Feature	Test Method	Performance
Moisture Sensitivity Level (MSL) at 260°C	JESD22-A113D	Level 3

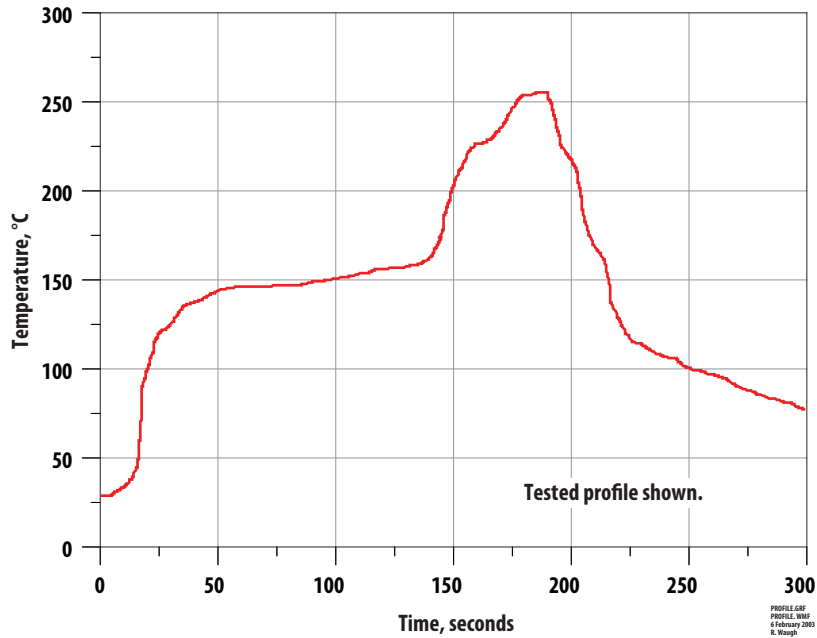

Figure 33. Verified SMT Solder Profile.

Ordering Information

Part Number	No. of Devices	Container
ACMD-7407-BLK	100	Anti-static Bag
ACMD-7407-TR1	3000	7-inch Reel

For product information and a complete list of distributors, please go to our web site: www.avagotech.com

Avago, Avago Technologies, and the A logo are trademarks of Avago Technologies in the United States and other countries. Data subject to change. Copyright © 2005-2009 Avago Technologies. All rights reserved.
AV02-1877EN - October 8, 2009

AVAGO
TECHNOLOGIES