

ACMD-7606

UMTS Band 8 Duplexer

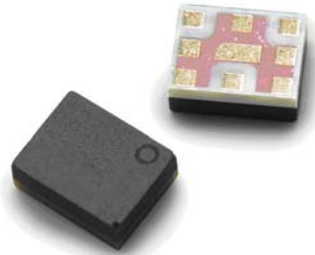

Data Sheet



Description

The Avago ACMD-7606 is a highly miniaturized duplexer designed for use in UMTS Band 8 (880 – 915 MHz UL, 925 – 960 MHz DL) handsets and mobile data terminals.

Low Insertion Loss in the Tx channel minimizes current drain from the power amplifier, while low Rx channel Insertion Loss improves receiver sensitivity.

The ACMD-7606 enhances the sensitivity and dynamic range of handset receivers by providing high isolation of the transmitted signal from the receiver input and high rejection of transmit-generated noise in the receive band.

The ACMD-7606 is designed with Avago Technologies' innovative Film Bulk Acoustic Resonator (FBAR) technology, which makes possible ultra-small, high-Q filters at a fraction of their usual size. The excellent power handling capability of FBAR bulk-mode resonators supports the high output power levels used in mobile communications applications, while adding virtually no distortion.

The ACMD-7606 also utilizes Avago Technologies' advanced Microcap bonded-wafer, chip scale packaging technology. This process allows the filters to be assembled into a molded chip-on-board module with an overall maximum size of 2.0 x 2.5 mm and maximum height of 0.95 mm. The ACMD-7606 is compatible with standard 2.0 x 2.5 mm duplexer PCB footprints.

Functional Block Diagram

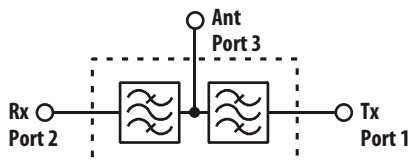

Features

- Miniature Size
 - 2.0 x 2.5 mm Max size
 - 0.95 mm Max Height
 - Standard 2 x 2.5 mm PCB footprint
- High Power Rating
 - 31 dBm Abs Max Tx Power
- Environmental
 - RoHS Compliant
 - Halogen free
 - TBBPA Free

Specifications

- Rx Band Performance, –20 to +85°C
 - Insertion Loss: 3.0 dB Max
 - Rx Noise Blocking: 50 dB Min
- Tx Band Performance, –20 to +85°C
 - Insertion Loss: 2.7 dB Max
 - Tx Interferer Blocking: 55 dB Min

Applications

Handsets or data terminals operating in the Band 8 frequency range.

ACMD-7606 Electrical Specifications ^[2], $Z_0=50\ \Omega$, T_C ^[1] as indicated

Symbol	Parameter	Units	-20°C			+25°C			+85°C		
			Min	Typ ^[3]	Max	Min	Typ ^[3]	Max	Min	Typ ^[3]	Max
Antenna Port to Receive Port											
S23	Insertion Loss in Receive Channels ^[4] (927.4 – 957.6 MHz)	dB			3.0		2.2	3.0			3.0
S22	Return Loss (SWR) of Receive Port in Receive Band	dB	8.5		(2.2)	8.5	10 (1.9)	(2.2)	8.5		(2.2)
S23	Attenuation in Transmit Band (880 – 915 MHz)	dB	45			45	55		45		
S23	Attenuation, 0 – 835 MHz	dB	28			28	32		28		
S23	Attenuation, 835 – 870 MHz	dB	30			30	32		30		
S23	Attenuation, 1805 – 1875 MHz	dB	35			35	37		35		
S23	Attenuation in Bluetooth Band (2400 – 2483.5 MHz)	dB	30			30	40		30		
S23	Attenuation, 2685 – 2790 MHz	dB	22			22	27		22		
Transmit Port to Antenna Port											
S31	Insertion Loss in Transmit Channels ^[4] (882.4 – 912.6 MHz)	dB			2.7		2.2	2.7			2.7
S11	Return Loss (SWR) of Transmit Port in Transmit Band	dB	8.5		(2.2)	8.5	10 (1.9)	(2.2)	8.5		(2.2)
S31	Attenuation in Receive Band (925 – 960 MHz)	dB	44			44	56		44		
S31	Attenuation, 0 – 820 MHz	dB	32			32	39		32		
S31	Attenuation in GPS Rx Band (1574.42 – 1576.42 MHz)	dB	27			27	30		27		
S31	Attenuation in Transmit 2 nd Harmonic Band (1760 – 1830 MHz)	dB	25			25	30		25		
S31	Attenuation in Bluetooth Band (2400 – 2483.5 MHz)	dB	27			27	30		27		
S31	Attenuation, 2640 – 2745 MHz	dB	22			22	30		22		
Antenna Port											
S33	Return Loss (SWR) of Ant Port in Rx Band (925 – 960 MHz)	dB	8.5		(2.2)	8.5	10 (1.9)				
S33	Return Loss (SWR) of Ant Port in Tx Band (880 – 915 MHz)	dB	8.5		(2.2)	8.5	10 (1.9)				
Isolation Transmit Port to Receive Port											
S21	Tx-Rx Isolation in Receive Band (925 – 960 MHz)	dB	50			50	55				
S21	Tx-Rx Isolation in Transmit Band (880 – 915 MHz)	dB	52			52	60				

Notes:

1. T_C is the case temperature and is defined as the temperature of the underside of the Duplexer where it makes contact with the circuit board.
2. Min/Max specifications are guaranteed at the indicated temperature with the input power to the Tx port equal to or less than +29 dBm over all Tx frequencies unless otherwise noted.
3. Typical data is the average value of the parameter over the indicated band at the specified temperature. Typical values may vary over time.
4. Integrated Insertion Loss over any 3.84 MHz channel within the band.

Absolute Maximum Ratings^[1]

Parameter	Unit	Value
Storage temperature	°C	-65 to +125
Maximum RF Input Power to Tx Port	dBm	+31

Maximum Recommended Operating Conditions^[2]

Parameter	Unit	Value
Operating temperature, T_C ^[3] , Tx Power \leq 29 dBm	°C	-40 to +100
Operating temperature, T_C ^[3] , Tx Power \leq 30 dBm	°C	-40 to +85

Notes:

1. Operation in excess of any one of these conditions may result in permanent damage to the device.
2. The device will function over the recommended range without degradation in reliability or permanent change in performance, but is not guaranteed to meet electrical specifications.
3. T_C is defined as case temperature, the temperature of the underside of the duplexer where it makes contact with the circuit board.

ACMD-7606 Typical Performance at $T_c = 25^\circ\text{C}$

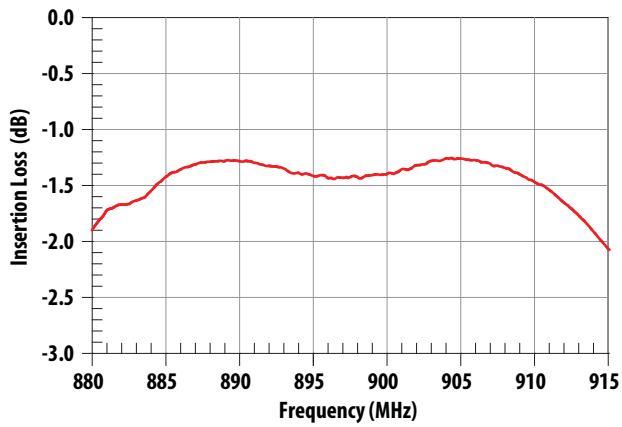

Figure 1. Tx-Ant Insertion Loss

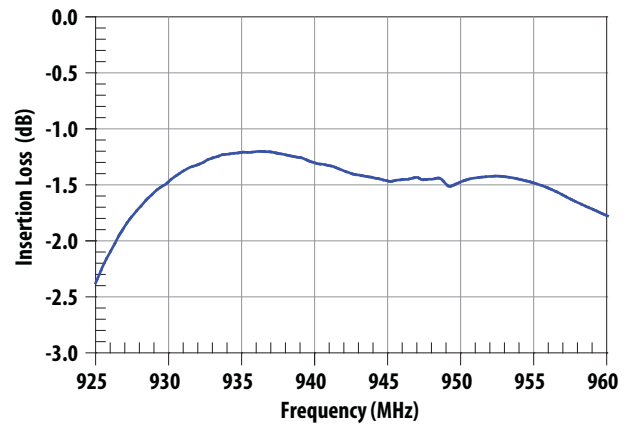

Figure 2. Ant-Rx Insertion Loss

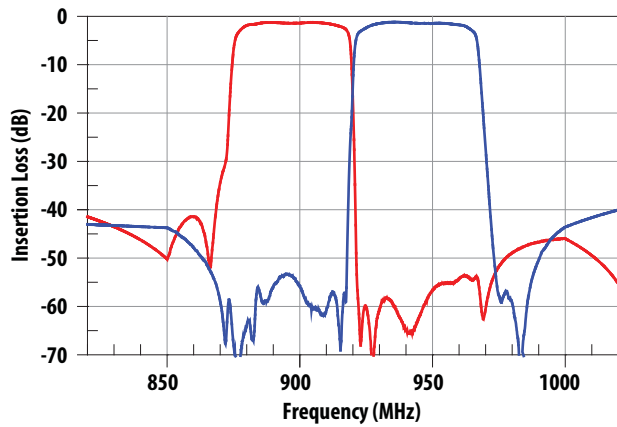

Figure 3. Tx Rejection in Rx Band and Rx Rejection in Tx Band

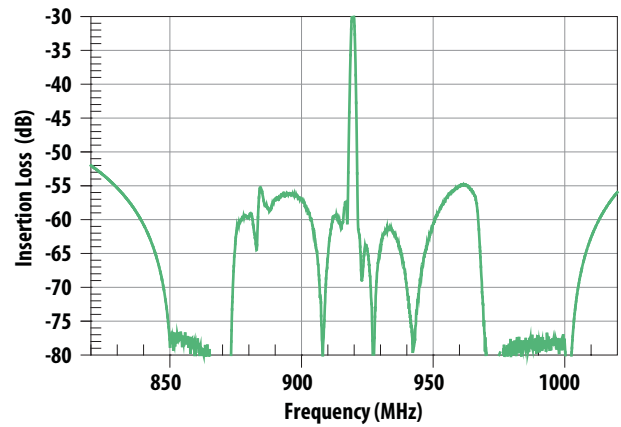

Figure 4. Tx-Rx Isolation

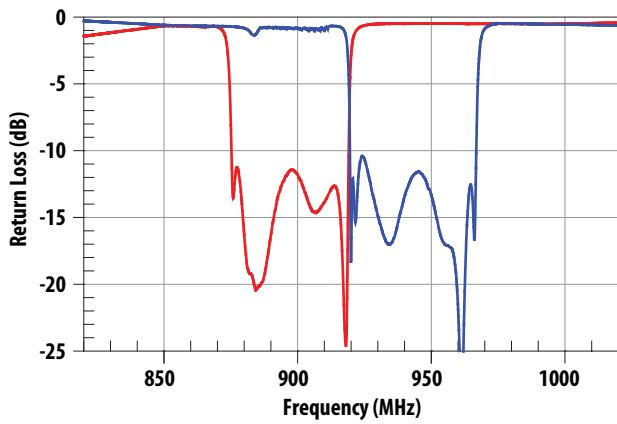

Figure 5. Tx and Rx Port Return Loss

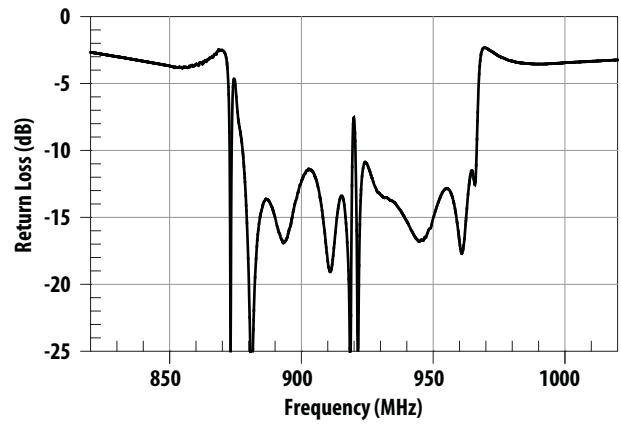

Figure 6. Antenna Port Return Loss

ACMD-7606 Typical Performance at Tc = 25°C

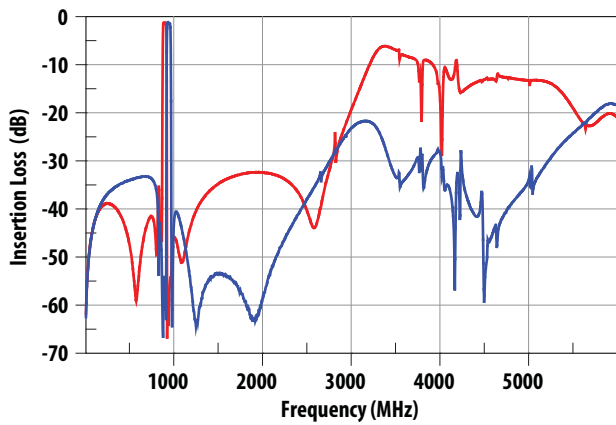

Figure 7. Tx-Ant and Ant-Rx Wideband Insertion Loss

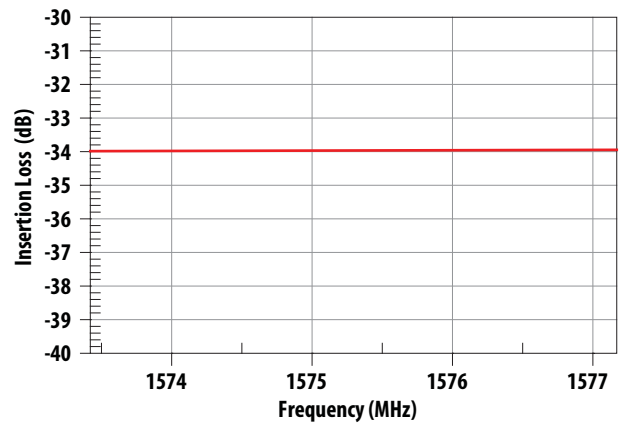

Figure 8. Tx-Ant Rejection in GPS Band

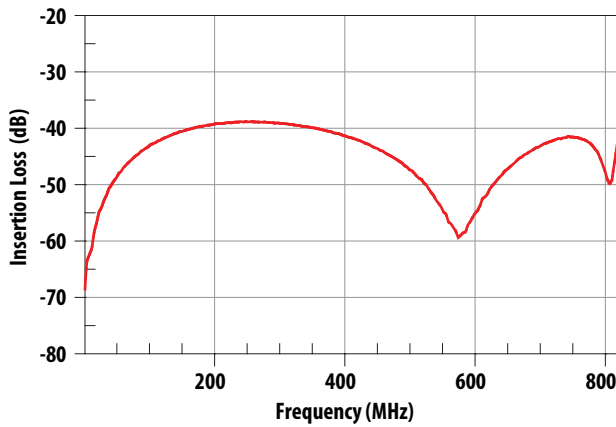

Figure 9. Tx-Ant Low Frequency Rejection, 1 - 820 MHz

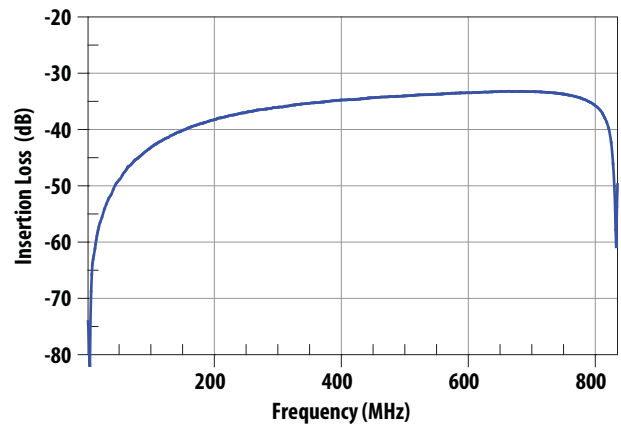

Figure 10. Ant-Rx Low Frequency Rejection, 1 - 835 MHz

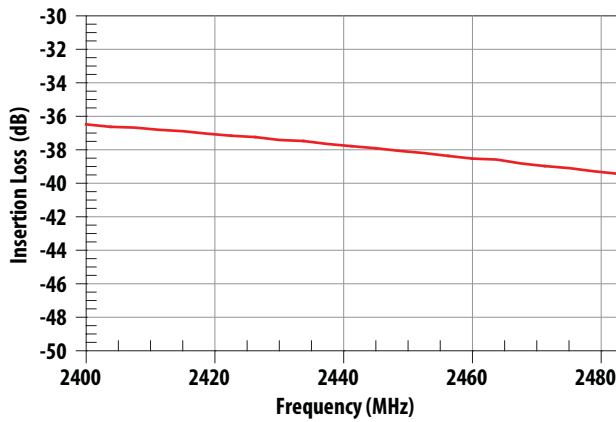

Figure 11. Tx-Ant Rejection in Bluetooth Band

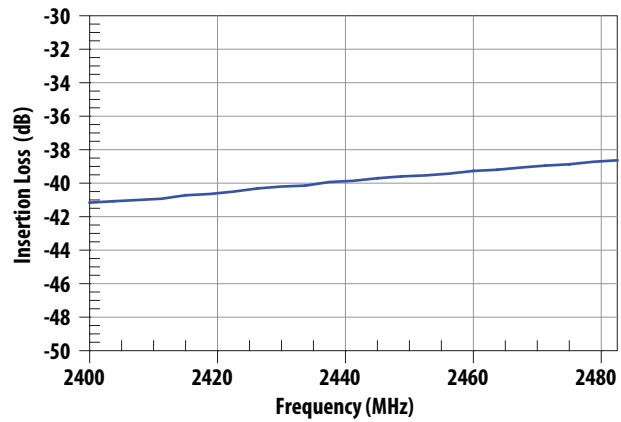

Figure 12. Ant-Rx Rejection in Bluetooth Band

ACMD-7606 Typical Performance at $T_c = 25^\circ\text{C}$

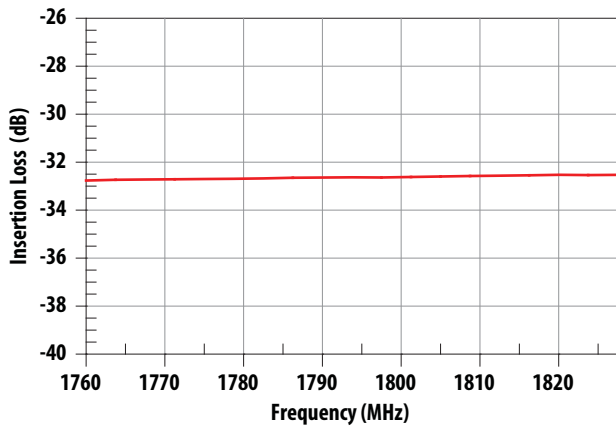

Figure 13. Tx-Ant Rejection at Tx Second Harmonic

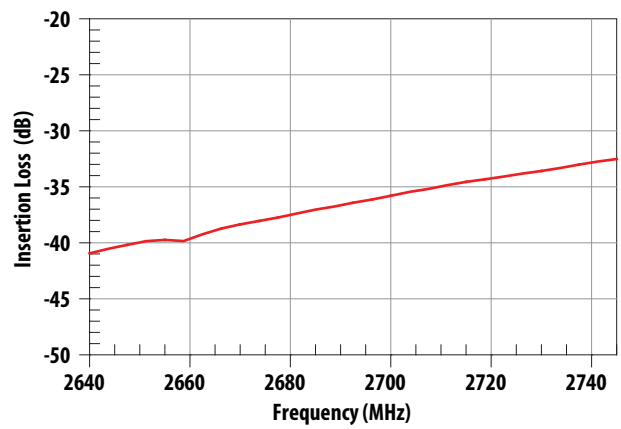

Figure 14. Tx-Ant Rejection, 2640 - 2745 MHz

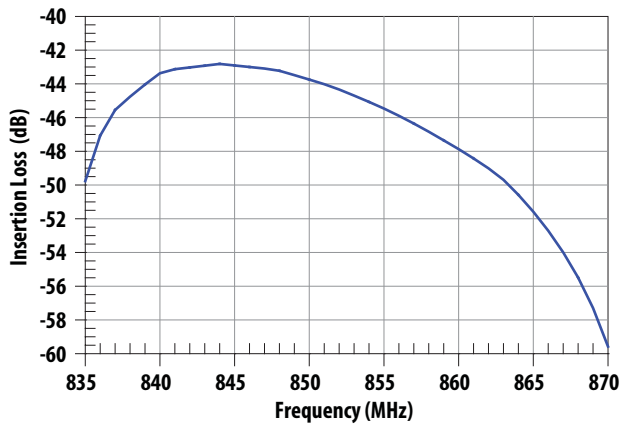

Figure 15. Ant-Rx Rejection, 835 - 870 MHz

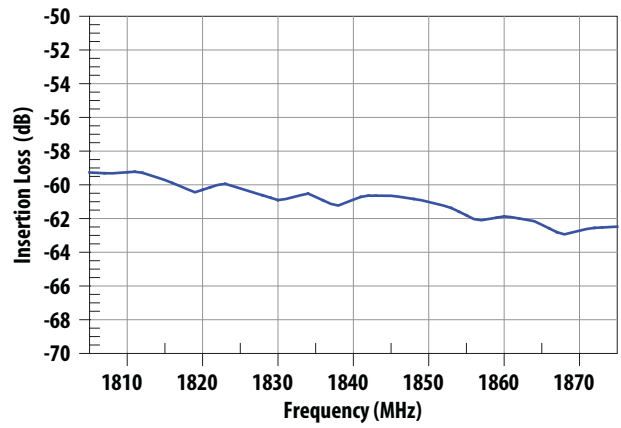

Figure 16. Ant-Rx Rejection, 1805 - 1875 MHz

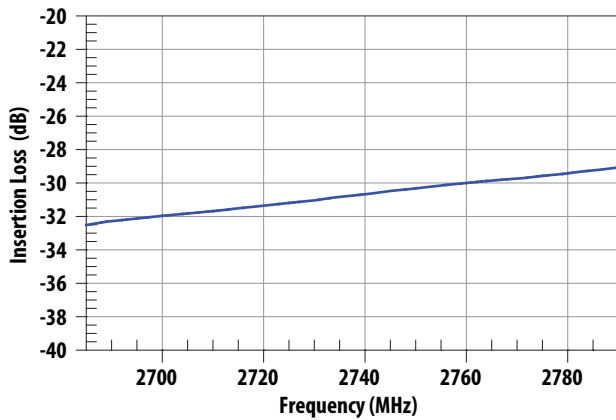

Figure 17. Ant-Rx Rejection, 2685 - 2790 MHz

ACMD-7606 Typical Performance at $T_c = 25^\circ\text{C}$

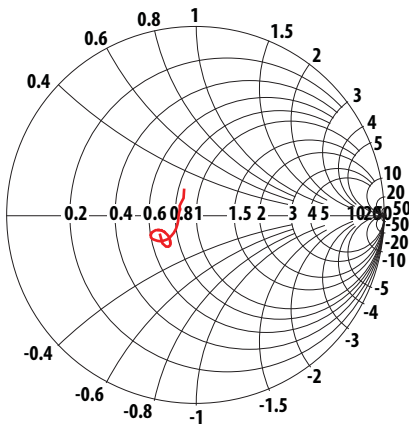

Figure 18. Tx Port Impedance in Tx Band

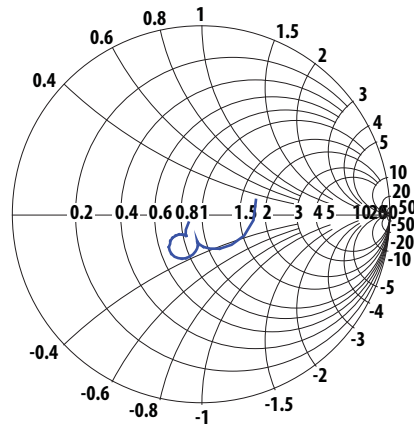

Figure 19. Rx Port Impedance in Rx Band

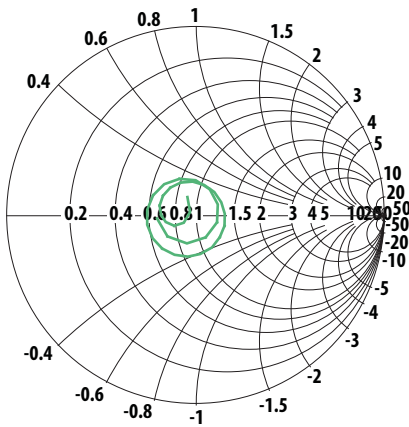

Figure 20. Ant Port Impedance in Tx Band

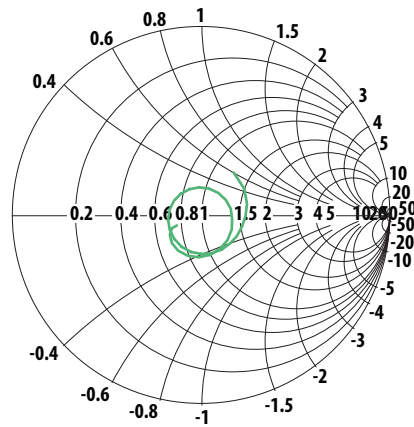
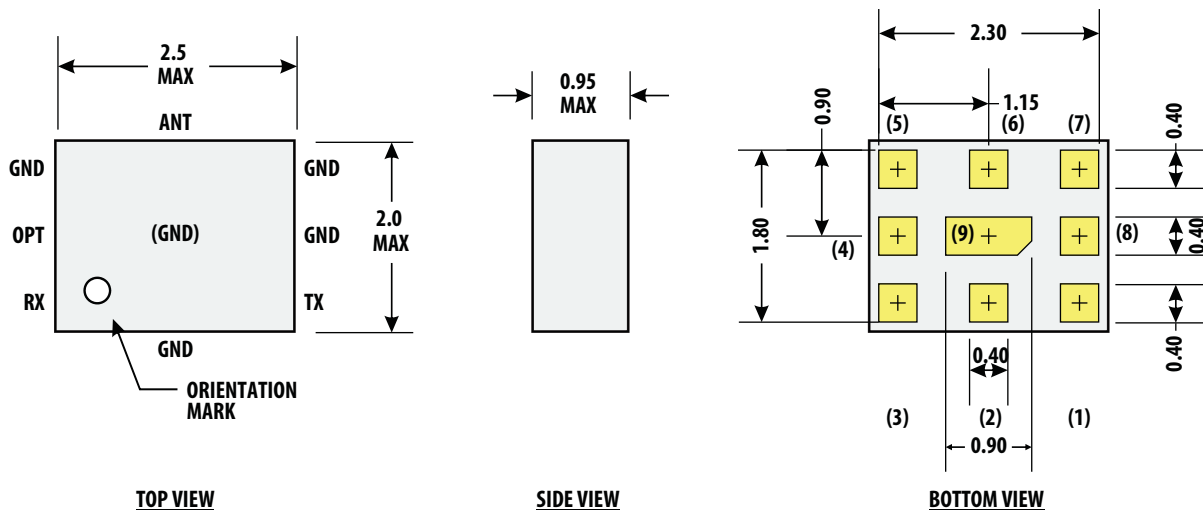

Figure 21. Ant Port Impedance in Rx Band



Notes:

1. Dimensions in millimeters
Tolerance: $X.X \pm 0.1$ mm
 $X.XX \pm 0.05$ mm
2. Dimensions nominal unless otherwise noted
3. Angles 45° nominal
4. I/O Pads (3 ea)
Size: 0.40×0.40 mm
Spacing to ground metal: 0.30 mm
5. Contact areas are gold plated

Pin Connections:

- | | |
|---------------|----------------------------|
| 1 | Rx |
| 2, 4, 5, 7, 9 | Gnd |
| 3 | Tx |
| 6 | Ant |
| 8 | Optional: Gnd, NC or Rx(-) |

Figure 22. Package Outline Drawing

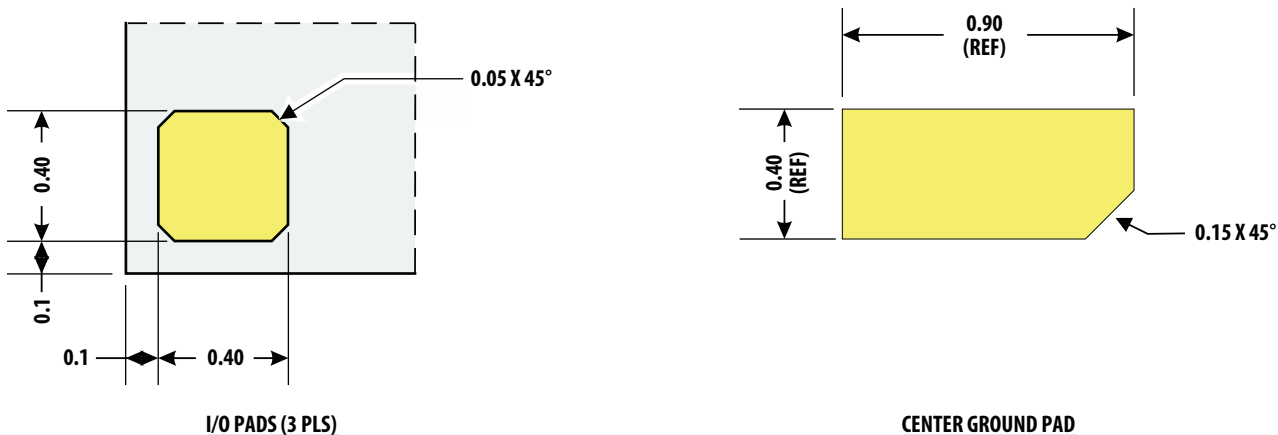

Figure 23. Pad Detail

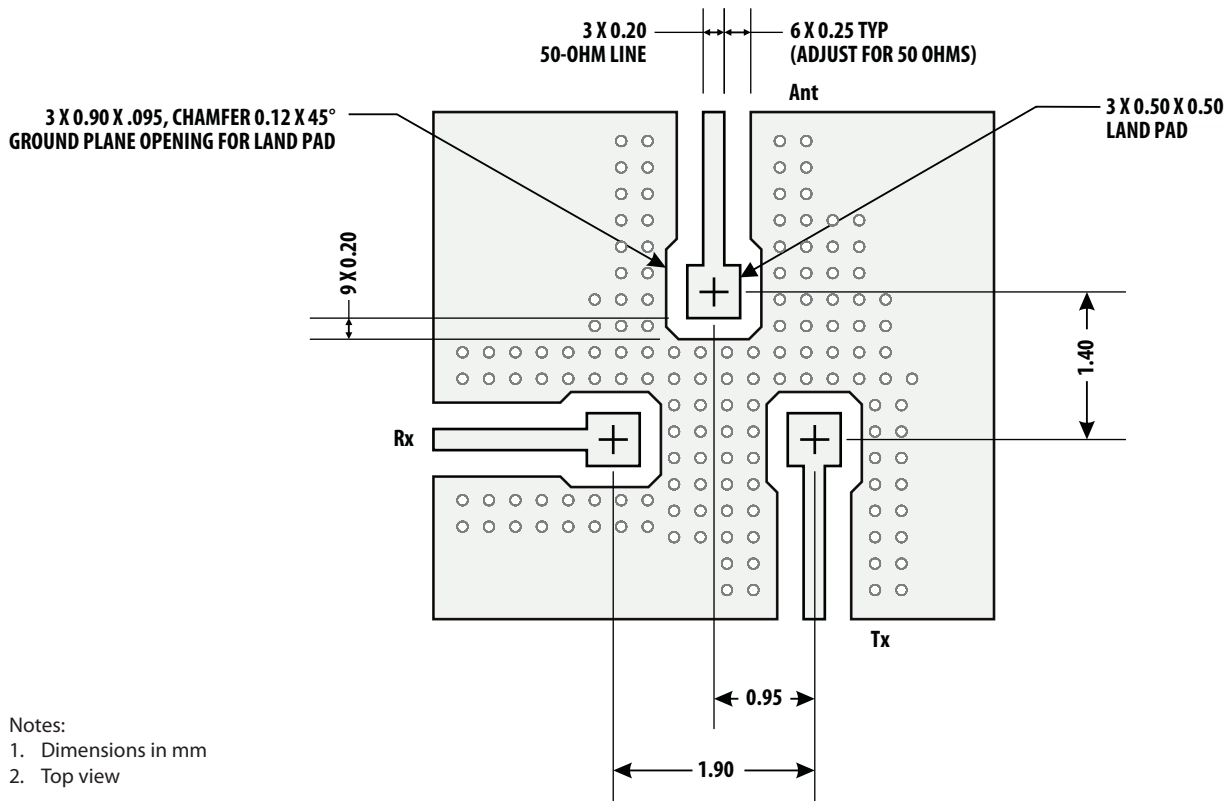

Figure 24. Suggested PCB Layout

A PCB layout using the principles illustrated in the figure above is recommended to optimize performance of the ACMD-7606.

The transmission line dimensions shown are designed to achieve an impedance of 50 ohms for an 80 μ m thick PCB layer with a dielectric constant of 3.4. If other PCB materials or thicknesses are used, the 0.25 mm gap spacing may need to be adjusted to retain a Z_0 of 50 ohms.

It is important to maximize isolation between the Tx and Rx ports.

High isolation is achieved by: (1) maintaining a continuous ground plane around the I/O connections and duplexer mounting area, and (2) surrounding the I/O ports with sufficient ground vias to enclose the connections in a "Faraday cage."

The ground vias under the ACMD-7606 mounting area are also needed to provide adequate heat sinking for the device.

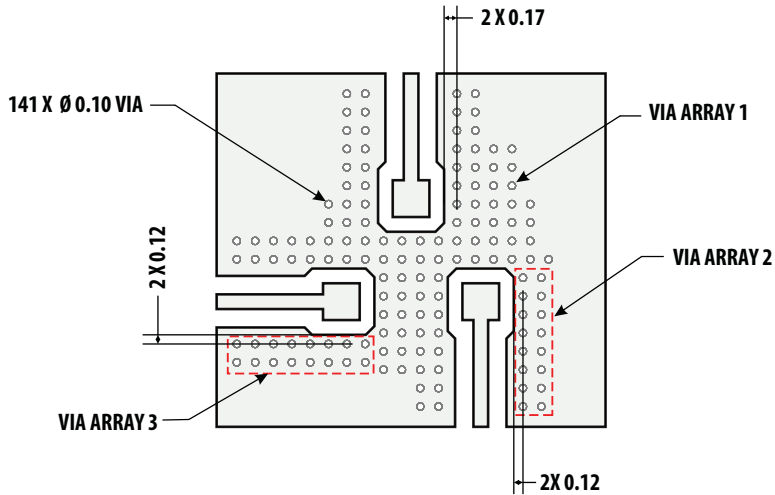

- Notes:
1. Dimensions in mm
 2. Top view
 3. Via arrays: horiz pitch = 0.25, vert pitch = 0.25

Figure 25. PCB Layout, Via Detail

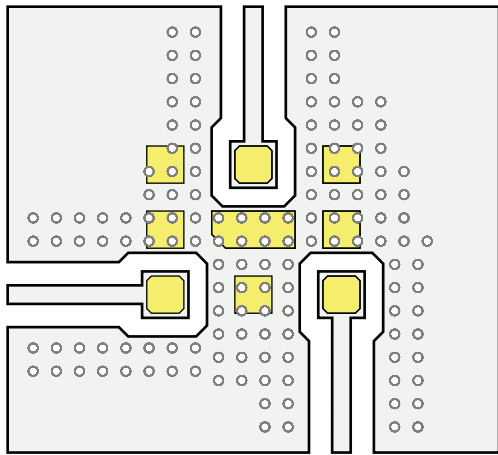

- Note:
1. Top view

Figure 26. ACMD-7606 Superposed on PCB Layout

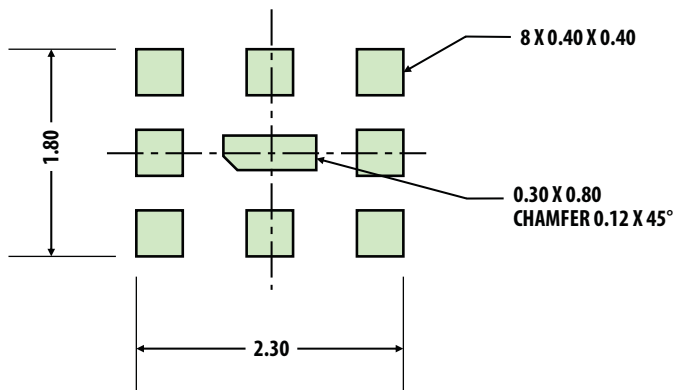

- Notes:
1. Dimensions in mm
 2. Top view
 3. Chamfer or radius all corners 0.05 mm min

Figure 27. Recommended Solder Stencil

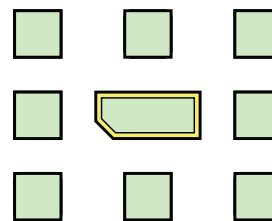

- Notes:
1. Top view
 2. Peripheral clearance of stencil aperture for center device pad is 0.05 mm. All other apertures match device pad 1:1

Figure 28. Solder Stencil Superposed on ACMD-7606

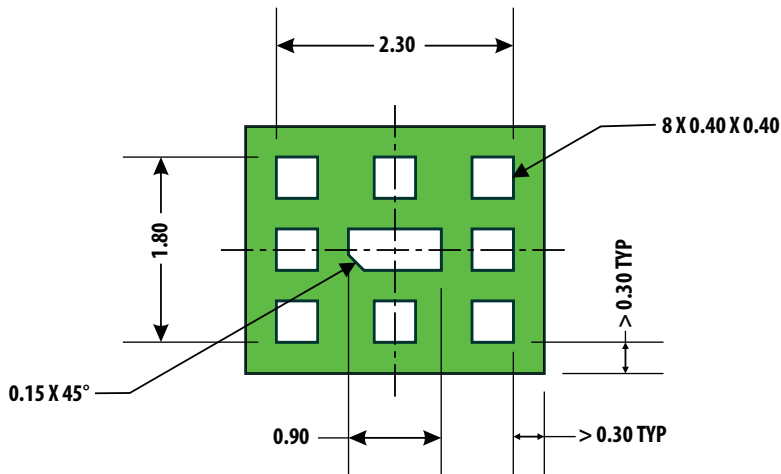

- Notes:
1. Dimensions in mm
 2. Top view

Figure 29. Recommended Solder Mask

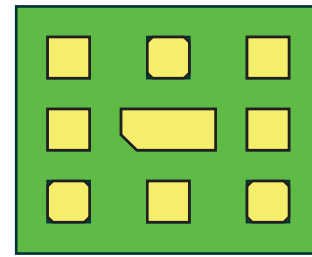

- Notes:
1. Top view
 2. Mask apertures match device pads 1:1

Figure 30. Solder Mask Superposed on ACMD-7606

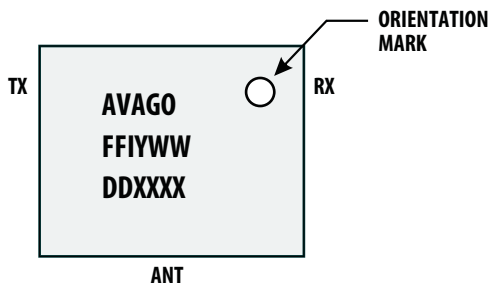

- F = ACMD-7606
- FI = Mfg Information
- Y = Year
- WW = Work Week
- DD = Date Code
- XXXX = Assembly Lot

Figure 31. Product Marking and Pin Orientation

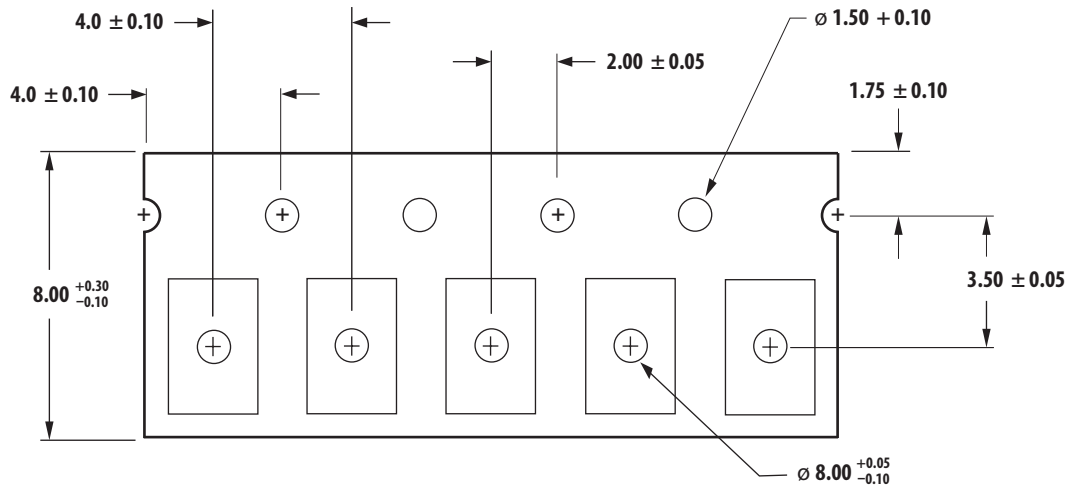

Figure 32. SMD Tape Packing

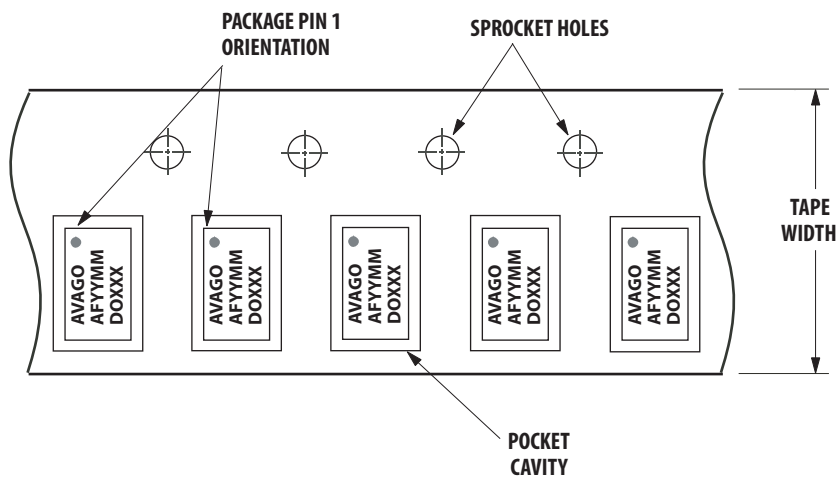
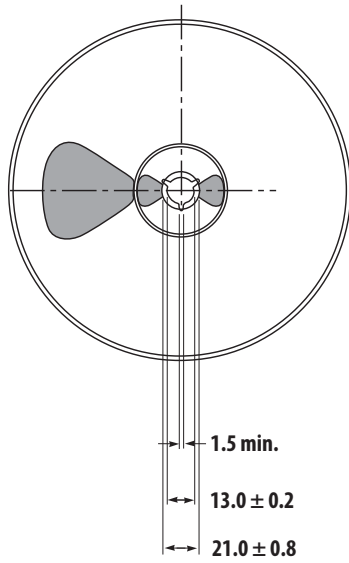

Figure 33. Unit Orientation in SMT Tape

FRONT VIEW



NOTES:

1. Reel shall be labeled with the following information (as a minimum).
 - a. manufacturers name or symbol
 - b. Avago Technologies part number
 - c. purchase order number
 - d. date code
 - e. quantity of units
2. A certificate of compliance (c of c) shall be issued and accompany each shipment of product.
3. Reel must not be made with or contain ozone depleting materials.
4. All dimensions in millimeters (mm)

BACK VIEW

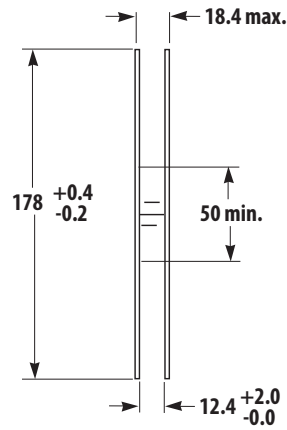
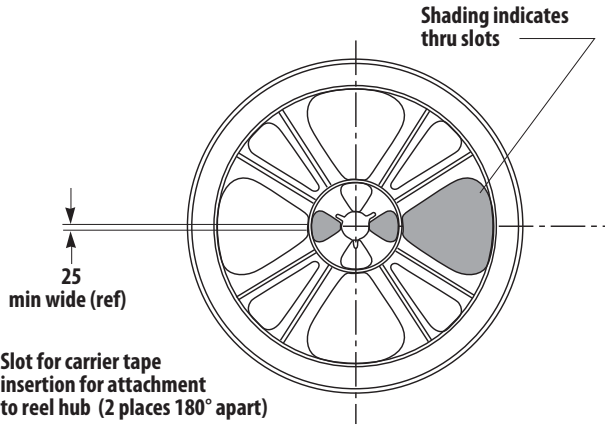

Figure 34. SMT Reel Drawing

Package Moisture Sensitivity

Feature	Test Method	Performance
Moisture Sensitivity Level (MSL) at 260°C	JESD22-A113D	Level 3

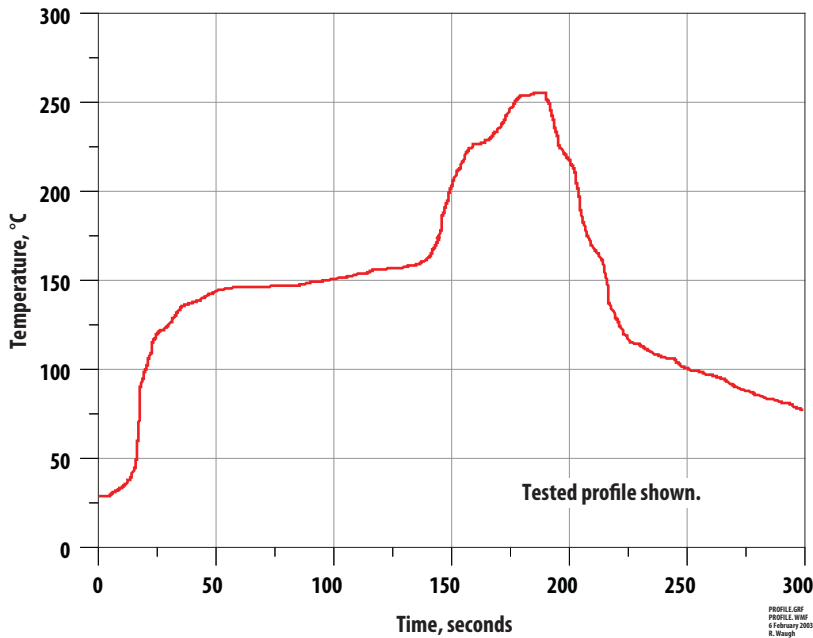

Figure 35. Verified SMT Solder Profile

Ordering Information

Part Number	No. of Devices	Container
ACMD-7606-BLK	100	Anti-static Bag
ACMD-7606-TR1	3000	7-inch Reel

For product information and a complete list of distributors, please go to our web site: www.avagotech.com

Avago, Avago Technologies, and the A logo are trademarks of Avago Technologies in the United States and other countries. Data subject to change. Copyright © 2005-2010 Avago Technologies. All rights reserved.
AV02-2362EN - February 25, 2010

AVAGO
TECHNOLOGIES