

ACPF-7001

High Rejection Tx Filter for US PCS Band

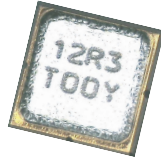

Data Sheet



Description

This product is a high rejection full band transmit filter designed for US PCS handsets. Its performance rivals splitband surface acoustic wave (SAW) transmit filters. Since the rejection is provided by a single filter, no switches are required, saving board space and external components, eliminating switch loss, and reducing programming complexity.

In typical cellular phone architectures, the transmit filter fits between the driver amplifier and the power amplifier. This filter reduces the noise in the Rx band being amplified by the transmit chain, enhancing receiver sensitivity. High rejection keeps unwanted signals out of the receive path.

Avago's thin-Film Bulk Acoustic Resonator (FBAR) technology makes possible high-Q filters at a fraction of their usual size.

Features

- High rejection from a single filter with no switches required
- Passband: 1850 – 1910 MHz
33 dB min Attenuation,
1930 – 1990 MHz
3.5 dB max Insertion Loss
- Space saving solution
Small footprint: 3 x 3-mm solution
Low profile package:
1.0 mm high (typ)
1.15 mm (max)

Applications

- US PCS band handsets
- Wireless data terminals

Package

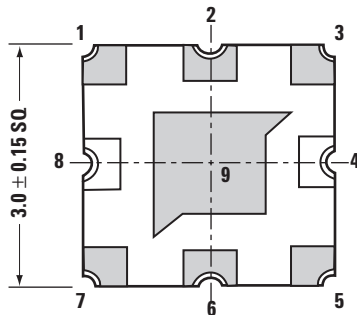

4: Input
8: Output
1, 2, 3, 5, 6, 7, 9: Grounded
Center pad grounded
See Figure 10 for details.
"x" = date code character

Electrical Specifications, $Z_0 = 50\Omega$

Symbol	Parameter	Units	25°C			-30° to +25°C			25° to +70°C		
			Min	Typ	Max	Min	Typ	Max	Min	Typ	Max
f	Passband	MHz	1850		1910	1850		1910	1850		1910
IL	Insertion Loss 1850-1855 MHz	dB		2.0	3.5			3.7			3.2
IL	Insertion Loss 1855-1905 MHz	dB		1.5	3.0			3.0			3.0
IL	Insertion Loss 1905-1910 MHz	dB		2.5	3.5			3.2			3.7
ΔS_{21}	Ripple, 1850-1910 MHz	dB			2.5						
S ₂₁	Min Rejection, 1930-1990 MHz	dB	33		37	33					33
S ₂₁	Min Rejection, 10-1800 MHz	dB	25								
S ₂₁	Min Rejection, 1990-3820 MHz	dB	30								
S ₂₁	Min Rejection, 3820-5730 MHz	dB		15							
S ₁₁ , S ₂₂	In-band Return Loss	dB	9.0		11	9.0		11	9.0		11
Pin max	Safe Input Power Level	dBm	20			20			20		

Absolute Maximum Ratings^[2]

Parameter	Unit	Value
Operating Temperature ^[1]	°C	-30 to +85
Storage Temperature ^[1]	°C	-30 to +100

Notes:

1. Temperature is defined at case T_c , the temperature of the underside of the filter where it makes contact with the circuit board.
2. Specifications are guaranteed over the given temperature range. Operation in excess of any one of these conditions may result in permanent damage to the device.

Typical Performance, 25°C, $Z_0 = 50\Omega$

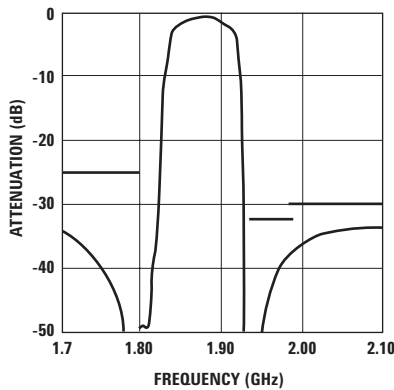

Figure 1. Attenuation vs. Frequency.

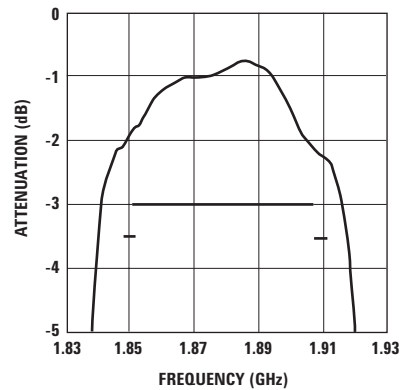

Figure 2. Insertion Loss vs. Frequency.

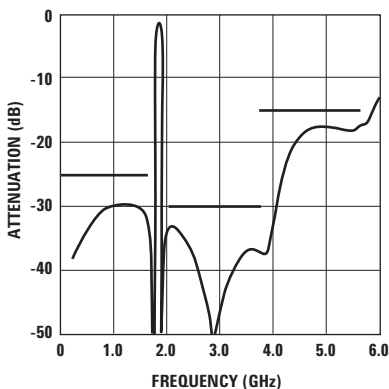

Figure 3. Attenuation vs. Frequency (Broadband).

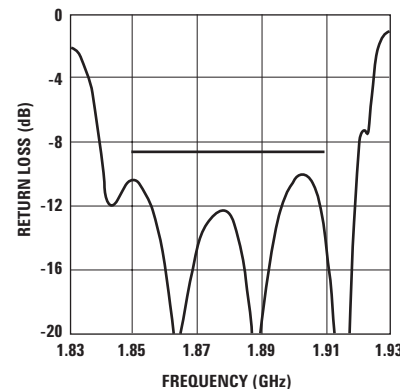

Figure 4. Return Loss vs. Frequency.

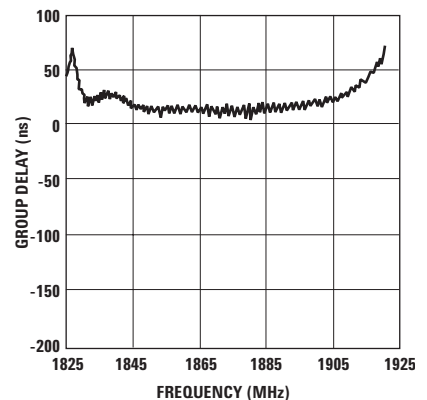

Figure 5. Group Delay vs. Frequency.

PCB Interface and Mounting Instructions

Mounting Consideration and Board Description

The ACPF-7001 filter has one input (Pin 4), one output (Pin 8) and 6 grounds (Pins 1, 2, 3, 5, 6, 7). Furthermore, the inside of the filter (center pad Pin 9) is ground-plane; therefore it must be soldered to PCB ground.

In summary:

- Pins 1, 2, 3, 5, 6, 7, 9 are grounded. (Figure 6)
- Demo board uses 10 mil top, 18 mil bottom Greek Coplanar Waveguide Over Ground plane (CPWG) style board. (See board layer Figure 6, 7)

Note: For best performance, try to reproduce this board stack up closely. The demoboard uses CPWG transmission lines for high isolation between two ports. It uses via holes to connect the CPWG line from the underside of the board to the filter mounting pads on top. If Ground-Signal-Ground (GSG) type board is used, better return loss can be achieved since it eliminates connector mismatch.

Demo Boards

SMA connectorized Demo boards are available for sampling. (See board drawing in Figure 6).

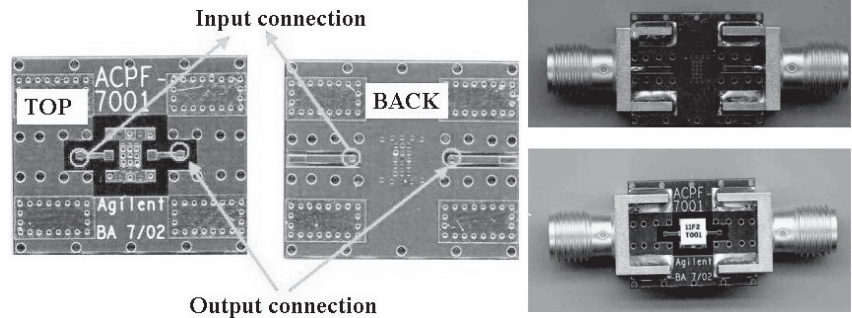

Figure 6. PCB top and bottom views (vias used to connect the underside of the board to the filter mounting pads on top).

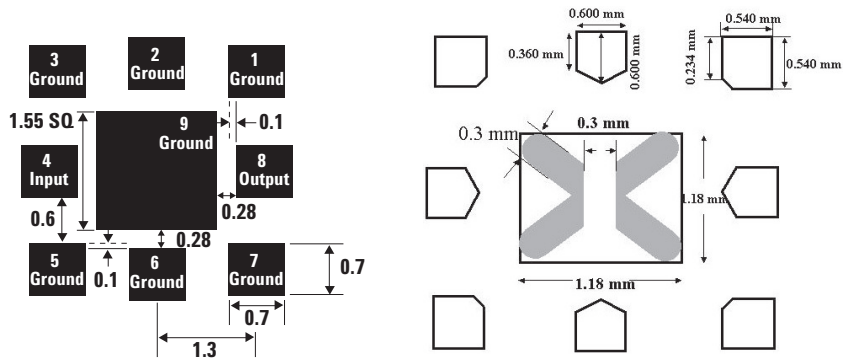

Figure 7a. PCB footprint dimensions, pad nomenclature, stencil dimensions (mm).

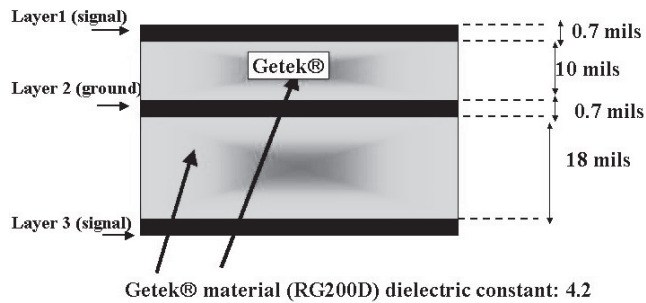
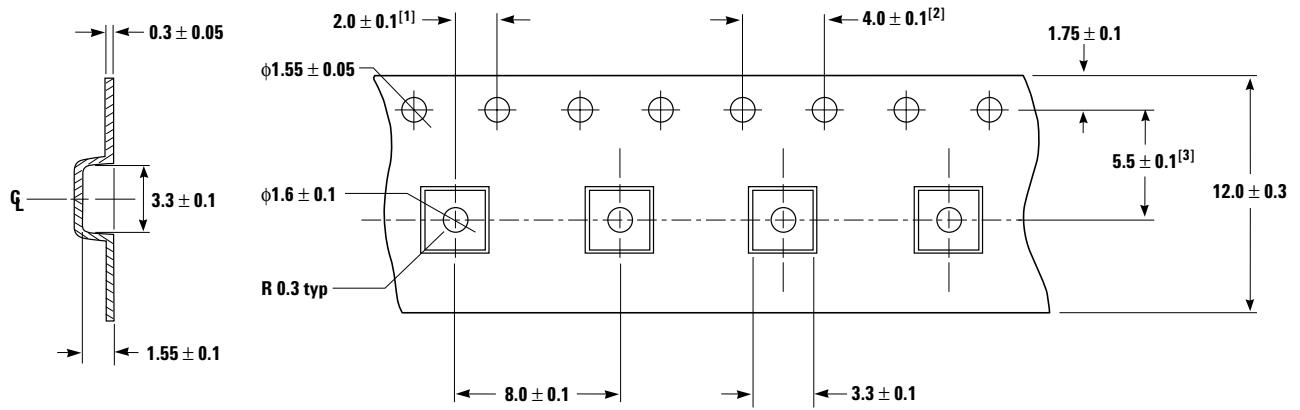

Figure 7b. Board stack up description.



Notes:

1. Measured from centerline of sprocket hole to centerline of pocket
 2. Cumulative tolerance of 10 sprocket holes is ± 0.20
- All dimensions in millimeters unless otherwise stated.

Figure 8. Tape drawing.

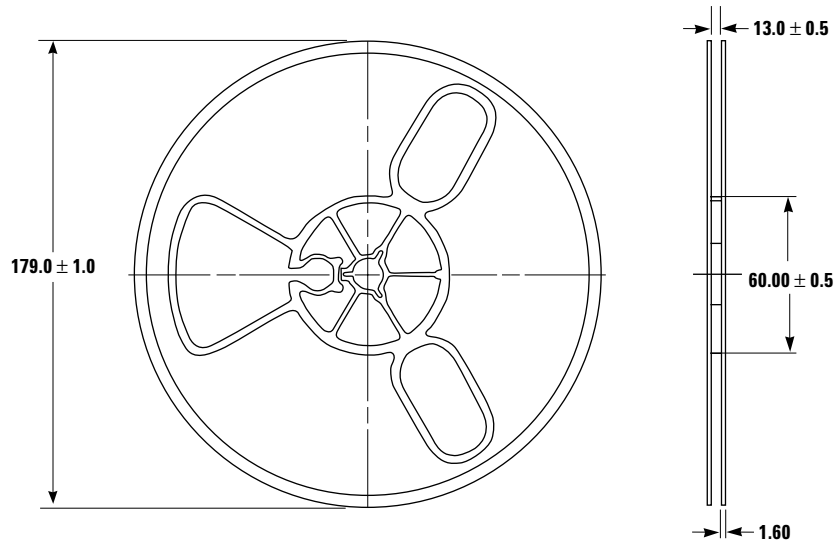
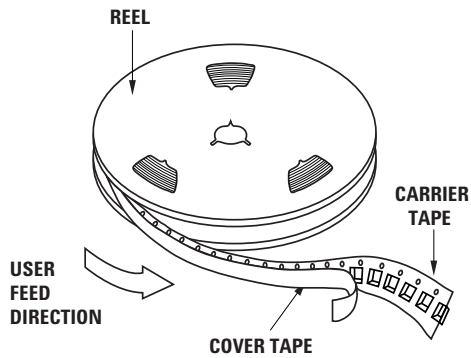

Figure 9. Reel drawing.



Notes:

1. Material polyester and acrylic adhesive layers
2. All dimensions in mm, except tape length.
3. Surface resistivity: 10^6 to 10^{12} ohms/sq

www.DataSheet4U.com

Figure 10a. Device orientation in the tape.

Ordering Information

Specify part number followed by option. For example:

ACPF-7001-XXX

Bulk or Tape and Reel option

Option Descriptions

-BLK = Bulk, 100 pcs. per antistatic bag

-TR1 = Tape and Reel, 1000 devices per 7" reel

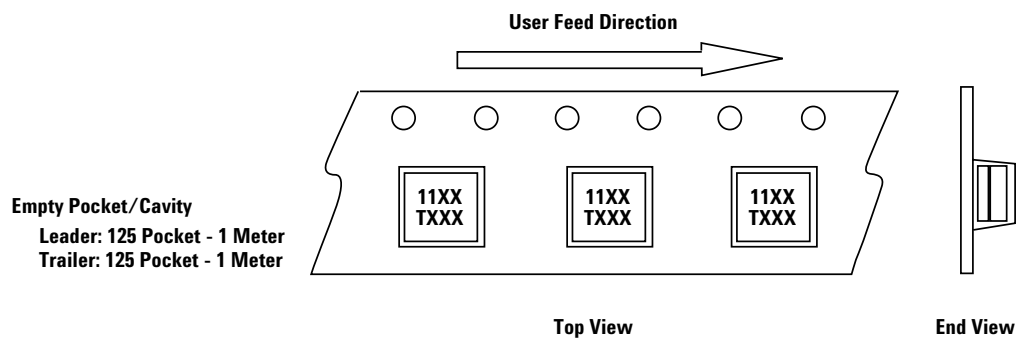

Figure 10b. Device orientation in the tape.

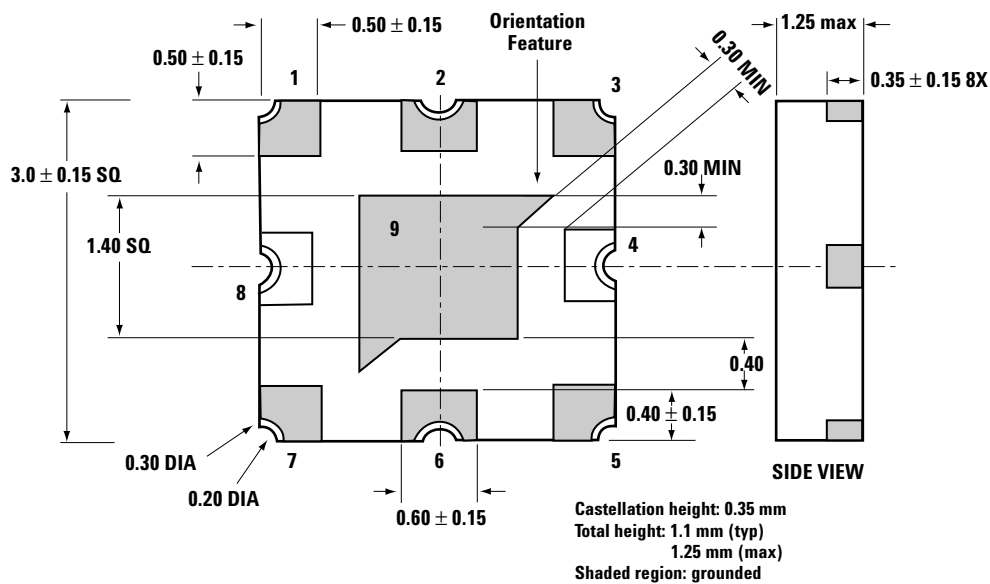

Figure 11. Detailed bottom and side view of package (dimensions in mm).

Alloy type	Melting temp. (°C)	Recommended working temperature (°C)	Comments
Sn42Bi58	138	160 – 180	Lead free
Sn43Pb43Bi14	144 – 163	165 – 185	Contains lead – some customers prohibit it
Sn63Pb37	183	200 – 240	Contains lead – some customers prohibit it
Sn60Pb40	186	200 – 240	Contains lead – some customers prohibit it
Sn91/Zn9	199	200 – 240	May have oxidation problems
Sn96.2Ag2.5Cu0.8Sb0.5	216	235 – 255	Popular lead free composition
Sn95.8Ag3.5Cu0.7	217	235 – 255	Other alloy ratios are available
Sn96.5Ag3.5	221	240 – 260	Used in the assembly of filters
Sn100	232	260 – 280	Too hot – will melt package assembly
Sn95Sb5	235	260 – 280	Too hot – will melt package assembly
Sn97Cu3	240	260 – 300	Too hot – will melt package assembly

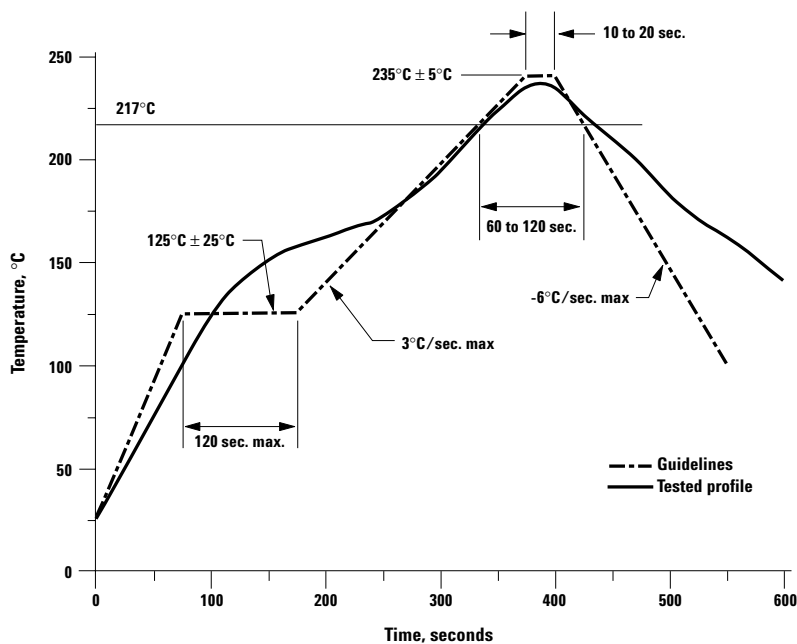

Figure 12. Recommended solder profile.

For product information and a complete list of distributors, please go to our web site:
www.avagotech.com

Avago, Avago Technologies, and the A logo are trademarks of Avago Technologies, Limited in the United States and other countries.
 Data subject to change. Copyright © 2006 Avago Technologies, Limited. All rights reserved.
 5988-8531EN August 2, 2006

