



Pentode Type ACPT8

HF POWER AMPLIFIER AND OSCILLATOR

General. A transmitting pentode fitted with a thoriated tungsten filament and a copper anode which is cooled by means of a radiator.

The valve is designed to give a large output at high frequencies, having a permissible anode dissipation of 750 W and giving useful output down to 9 metres. With forced air cooling the anode dissipation may be increased to 1.1 kW. At this rating the volume of air required is 10 cu. ft. per minute at a pressure equal to 3-in. head of water.

In view of the low suppressor volts required for anode current cut-off, this valve is very suitable for suppressor modulation.

The screen and control grids are aligned, giving high overall efficiency.

The figures quoted for maximum permissible ratings are only applicable for use at wavelengths down to 15 metres. At shorter wavelengths the maximum permissible anode voltage and input must be reduced to the following percentage of the quoted figures:

For operation down to 13 metres	85%
For operation down to 11.5 metres	70%
For operation down to 10.5 metres	60%
For operation down to 9.5 metres	50%

APPROXIMATE DATA

V_f	11	V
I_f	16	A
g_m^* (taken at V_a 4,500, V_{g2} 800, p_a 750 W)	6.5	mA/V
g_m^* (taken at $\frac{1}{2} I_e$ pk)	10	mA/V
I_e^* (pk)	4.25	A
C_{a-g1}	0.1	pF
C_{in}	65	pF
C_{out}	26	pF

* No attempt must be made to measure these figures statically.

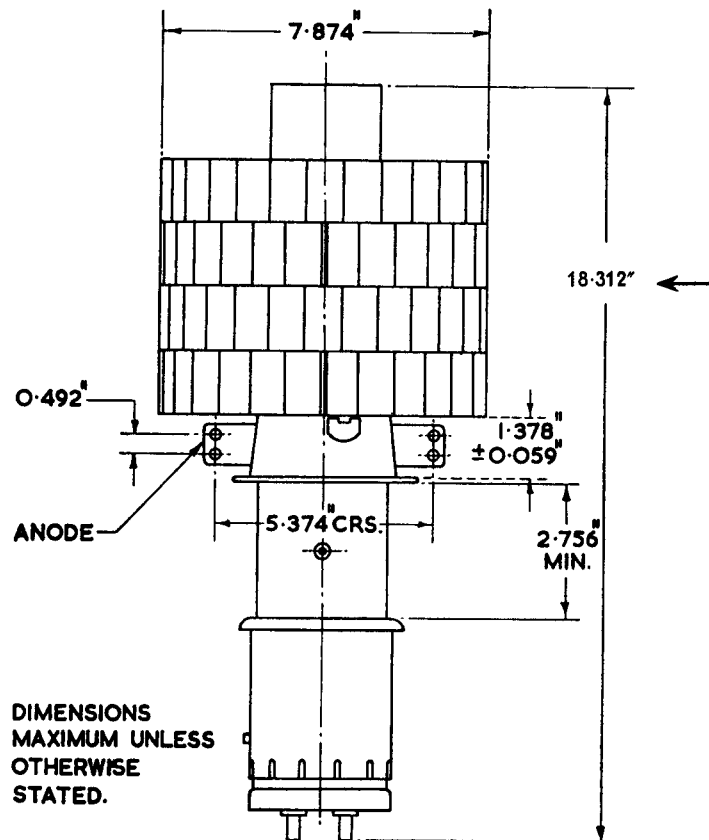

DIMENSIONS
MAXIMUM UNLESS
OTHERWISE
STATED.

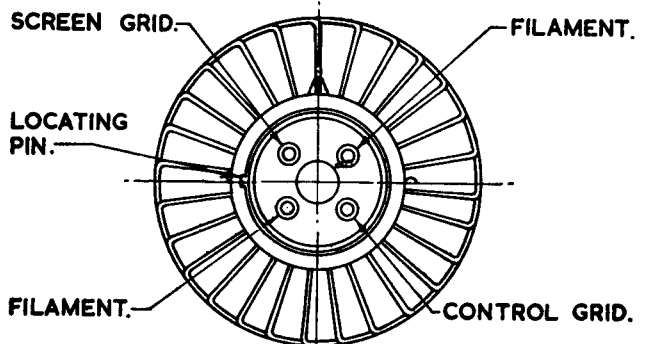

WEIGHT 10.5lb. (4.8kg)

MARCONI'S WIRELESS TELEGRAPH COMPANY LIMITED

Chelmsford, Essex, England. Telephone: Chelmsford 3221. Telex: 1953. Telegrams: Expanse Chelmsford Telex

**(1) HF POWER AMPLIFIER
AND OSCILLATOR
CLASS C TELEGRAPHY**

(Unmodulated, one valve, key down conditions)

Maximum permissible ratings

V_a		4,500	V
I_a		600	mA
P_{in}	$\left\{ \begin{array}{l} V_{g3} + 80 \text{ V} \\ V_{g3} \quad 0 \text{ V} \end{array} \right.$	2.5	kW
		2.2	kW
I_{g1}		100	mA
V_{g2}		800	V
P_{g2}		100	W
P_a		750	W

Typical Operation

V_a	4,500	4,500	3,500	2,500	V
I_a	550	475	380	330	mA
V_{g2}	800	500	500	500	V
I_{g2}	120	180	160	160	mA
P_{g2}	96	90	80	80	W
V_{g3}	+80	0	0	0	V
V_{g1}	-250	-200	-200	-200	V
I_{g1}	60	90	80	80	mA
R_{g1-k}	4,000	2,200	2,500	2,500	Ω
$V_{g1} \text{ (pk)}$	400	400	350	350	V
$P_{dr} \text{ (b)}$	40	50	40	40	W
Z_a	3,600	4,000	4,000	3,200	Ω
p_a	700	650	380	275	W
P_{out}	1,800	1,500	950	550	W

**(2) HF POWER AMPLIFIER
CLASS C**

(Grid modulated, one valve, carrier conditions, permissible modulation 100%)

Maximum permissible ratings

V_a		4,500	V
I_a		300	mA
P_{in}		1.15	kW
I_{g1}		100	mA
V_{g2}		800	V
P_{g2}		100	W
P_a		750	W

Typical Operation

V_a		4,500	3,500	V
I_a		225	210	mA

V_{g2}	800	800	V
I_{g2}	20	20	mA
P_{g2}	16	16	W
V_{g3}	0	0	V
V_{g1}	-160	-155	V
I_{g1}	5	5	mA
$V_{g1} \text{ (pk)}$	185	170	V
$P_{dr} \text{ (b) (c)}$	10	10	W
$v_{pk} \text{ (mod) (d)}$	80	80	V
$P_{mod} \text{ (d)}$	2.5	2.5	W
$Z_a \text{ (mod)}$	2,500	2,500	Ω
Z_a	4,500	4,000	Ω
p_a	650	500	W
P_{out}	350	240	W

**(3) HF POWER AMPLIFIER
CLASS C**

(Anode modulated, one valve, carrier conditions, permissible modulation 100%)

Maximum permissible ratings

V_a		3,500	V
I_a		350	mA
P_{in}		1.2	kW
I_{g1}		100	mA
V_{g2}		800	V
P_{g2}		100	W
P_a		500	W

Typical Operation

V_a	3,500	2,500	V
I_a	300	265	mA
V_{g2}	500	500	V
R_{g2}	30,000	20,000	Ω
I_{g2}	90	95	mA
P_{g2}	45	47.5	W
V_{g3}	0	0	V
V_{g1}	-100	-90	V
$I_{g1} \text{ (b)}$	48	45	mA
$v_{g1} \text{ (pk)}$	190	190	V
$P_{dr} \text{ (b)}$	14	14	W
$P_{mod} \text{ (d)}$	680	400	W
$Z_a \text{ (mod)}$	9,000	8,000	Ω
Z_a	5,500	4,500	Ω
p_a	350	190	W
P_{out}	700	450	W

(4) HF POWER AMPLIFIER*(Suppressor modulated, one valve, carrier conditions, permissible modulation 100%)**Maximum permissible ratings*

V_a	4,500	V
I_a	250	mA
P_{1n}	1.12	kW
I_{g1}	100	mA
V_{g2}	800	V
P_{g2}	100	W
p_a	750	W

Typical Operation

V_a	4,500	4,500	V
I_a	200	200	mA
V_{g2}	500	(a)	V
I_{g2}	180	120	mA
P_{g2}	90	90	W
V_{g3}	-160	-135	V
V_{g1}	-120	-120	V
I_{g1} (b)	95	45	mA
V_{g1} (pk)	250	230	V
P_{dr} (b)	30	15	W
v_{pk} (mod) (d)	160	135	V
P_{mod} (d)	Negligible	Negligible	
Z_a	5,500	5,500	Ω
p_a	600	580	W
P_{out}	300	320	W

(5) HF POWER AMPLIFIER**CLASS B TELEPHONY***(One valve, carrier conditions, permissible modulation 100%)**Maximum permissible ratings*

V_a	4,500	V
I_a	300	mA
P_{1n}	1.1	kW
V_{g2}	800	V
P_{g2}	100	W
p_a	750	W

Typical Operation

V_a	4,500	3,500	V
I_a	240	240	mA
V_{g2}	800	800	V
I_{g2}	20	20	mA
P_{g2}	16	16	W
V_{g3}	0	0	V
V_{g1}	-85	-85	V
I_{g1} (b)	1	1.5	mA
V_{g1} (pk)	85	85	V
P_{dr} (b) (c)	5	6	W
Z_a	4,750	4,000	Ω
p_a	740	580	W
P_{out}	340	250	W

NOTES

(a) Screen voltage obtained by means of a dropping resistance of 30,000 Ω from anode HT supply.

(b) Subject to wide variation. The figures are approximate only.

(c) At crest of audio cycle with 100% modulation.

(d) 100% modulation.

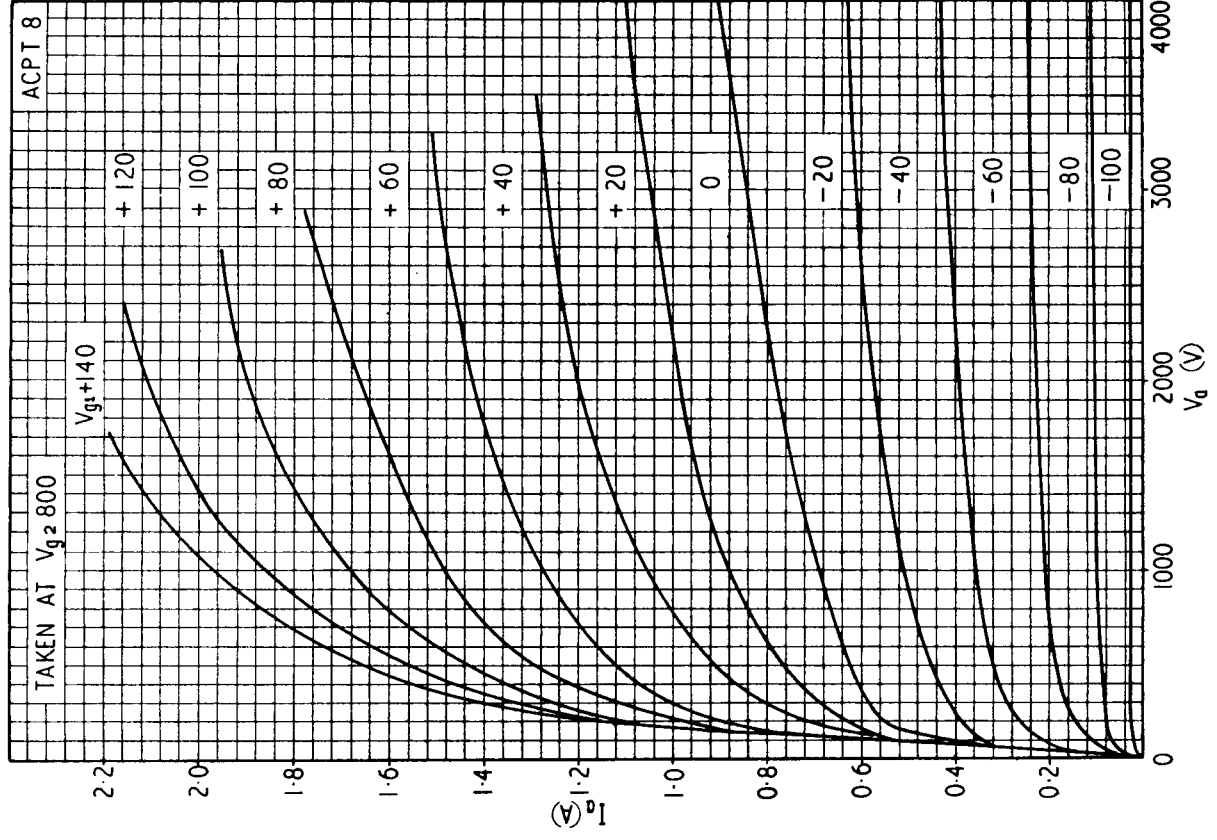
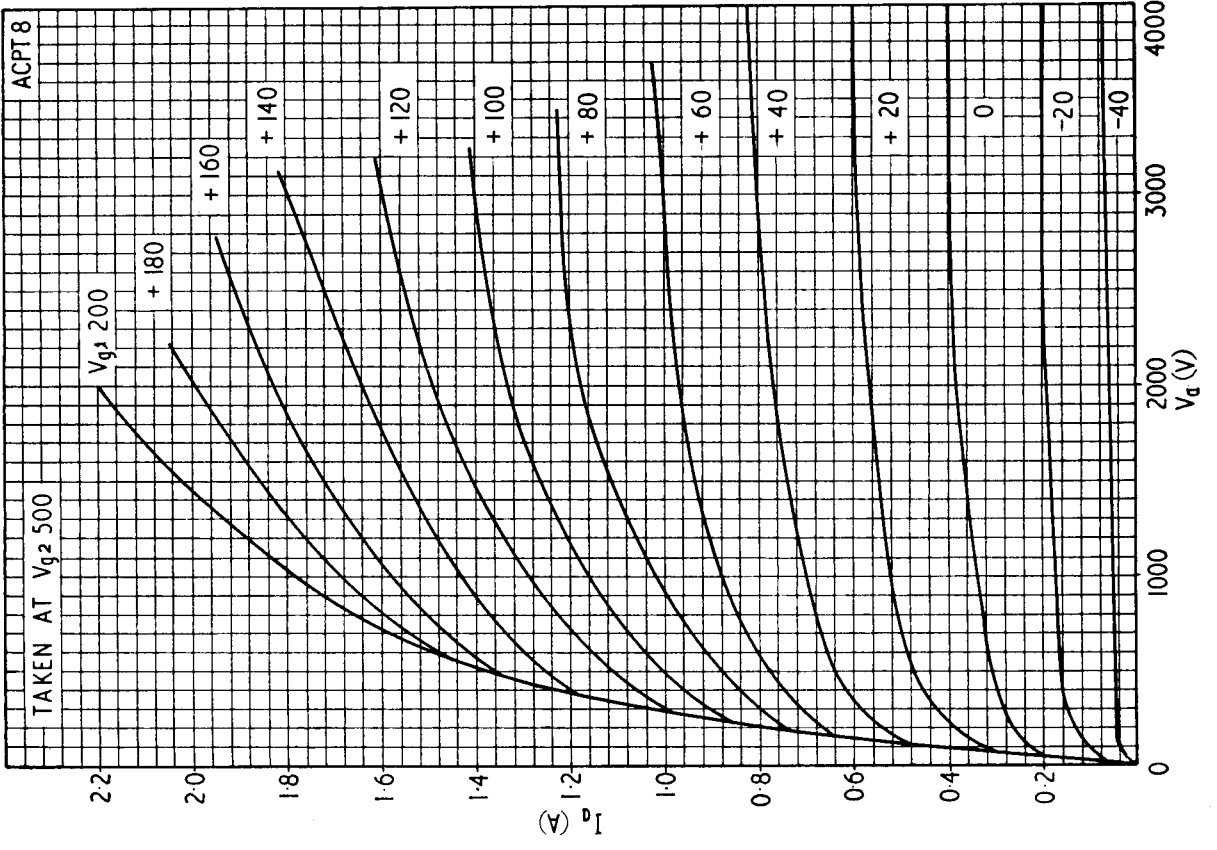

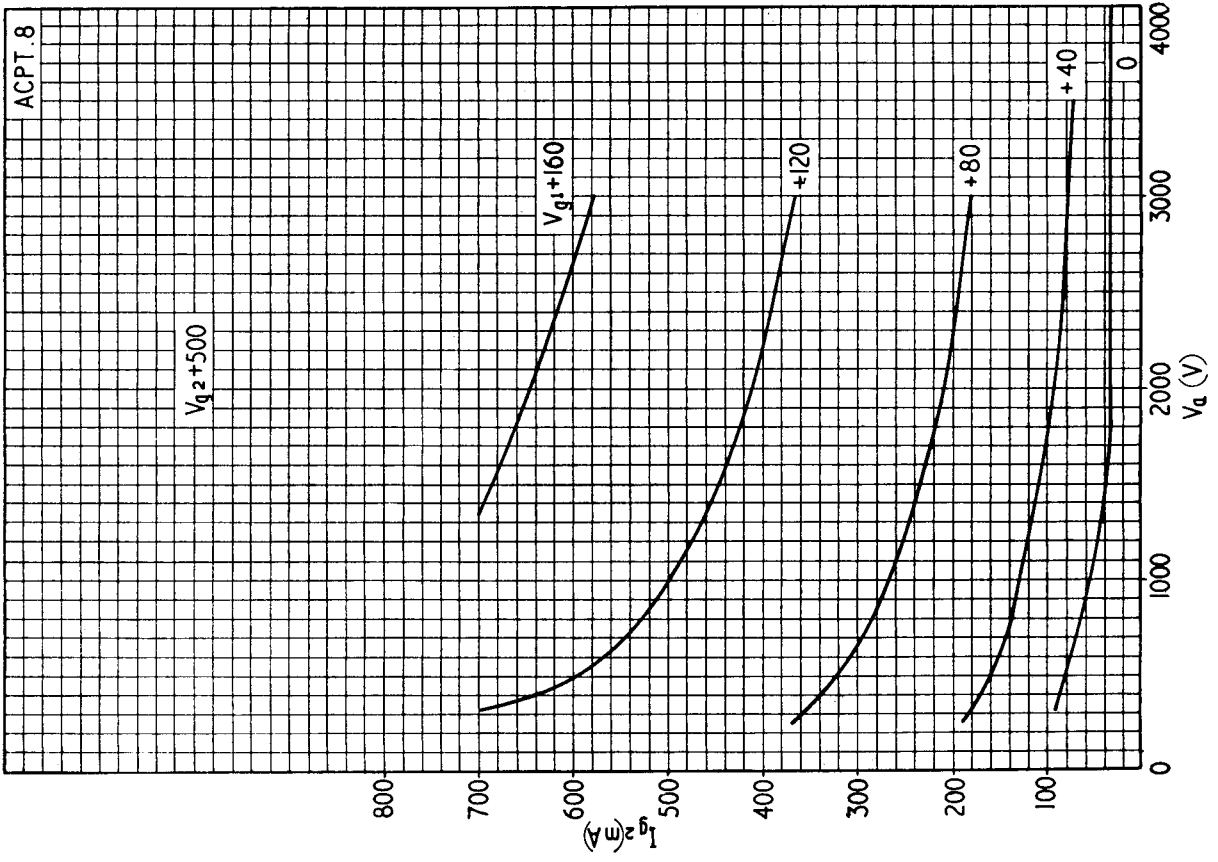
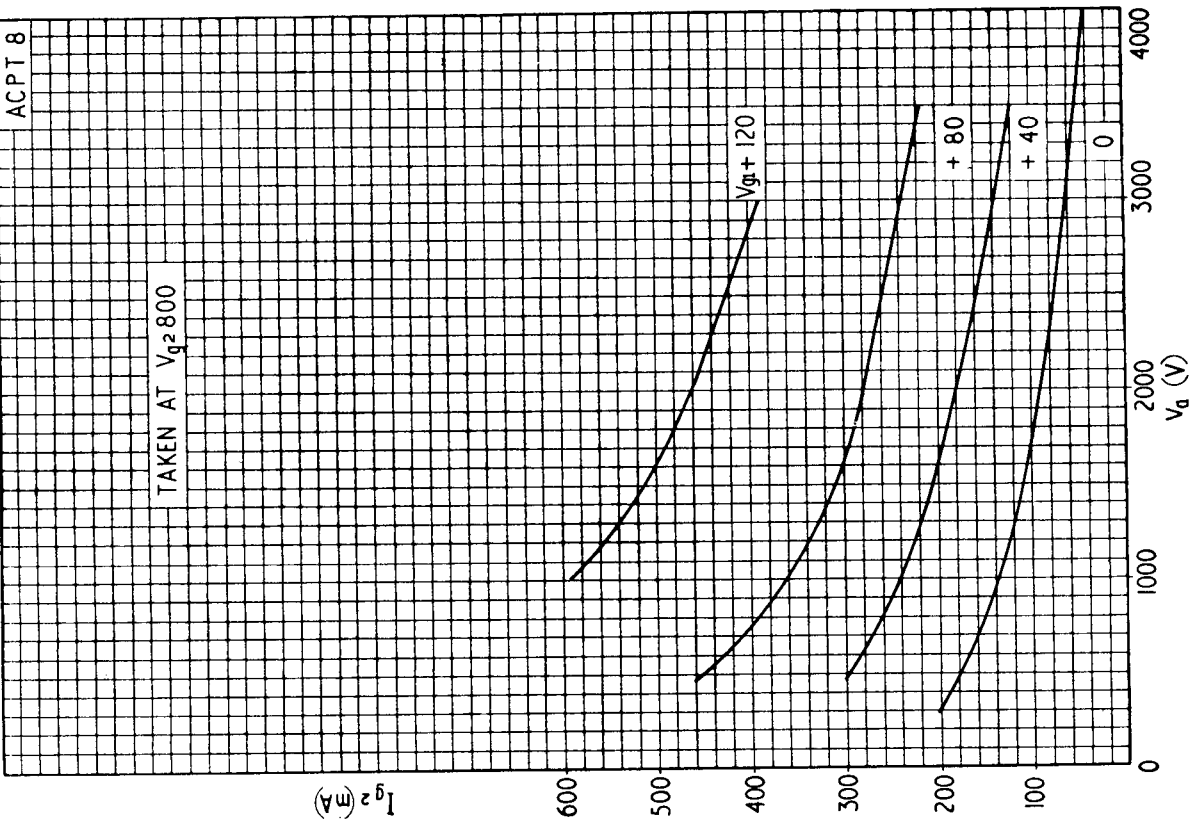

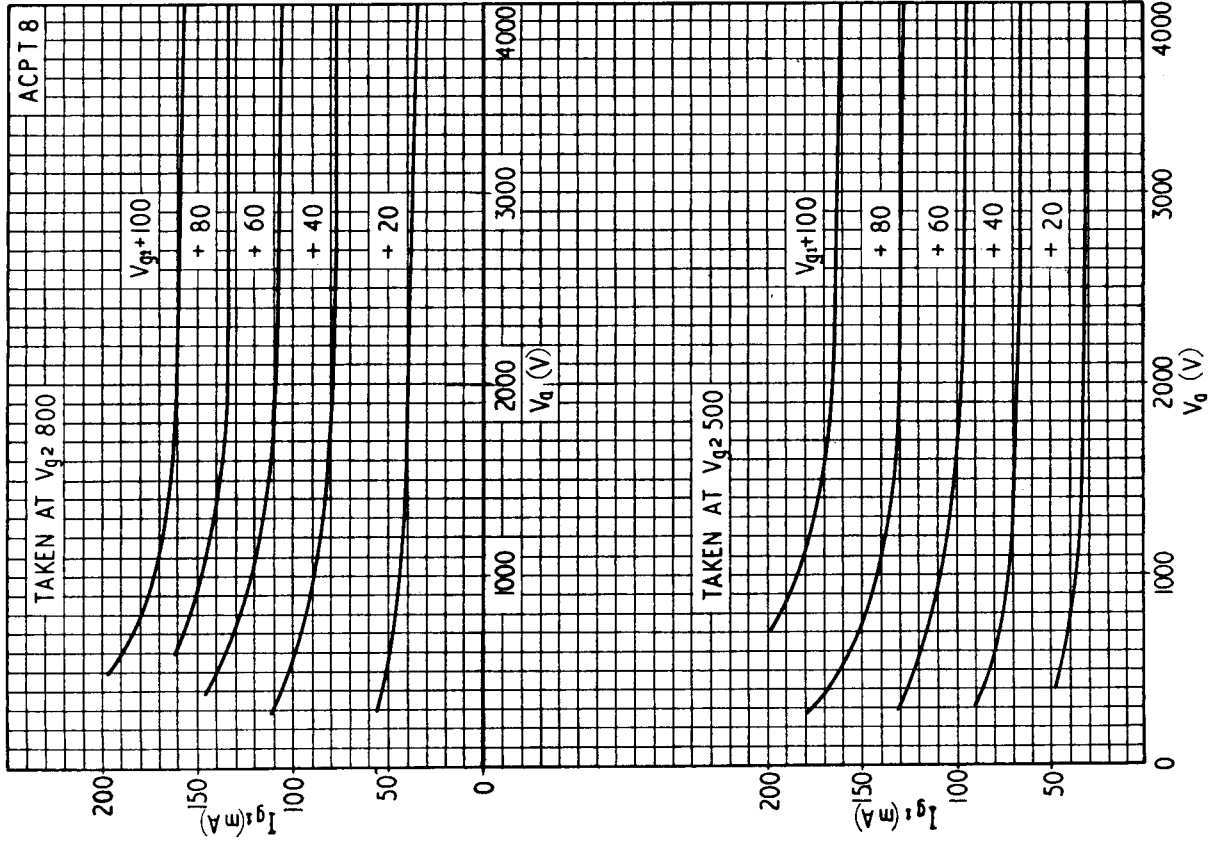
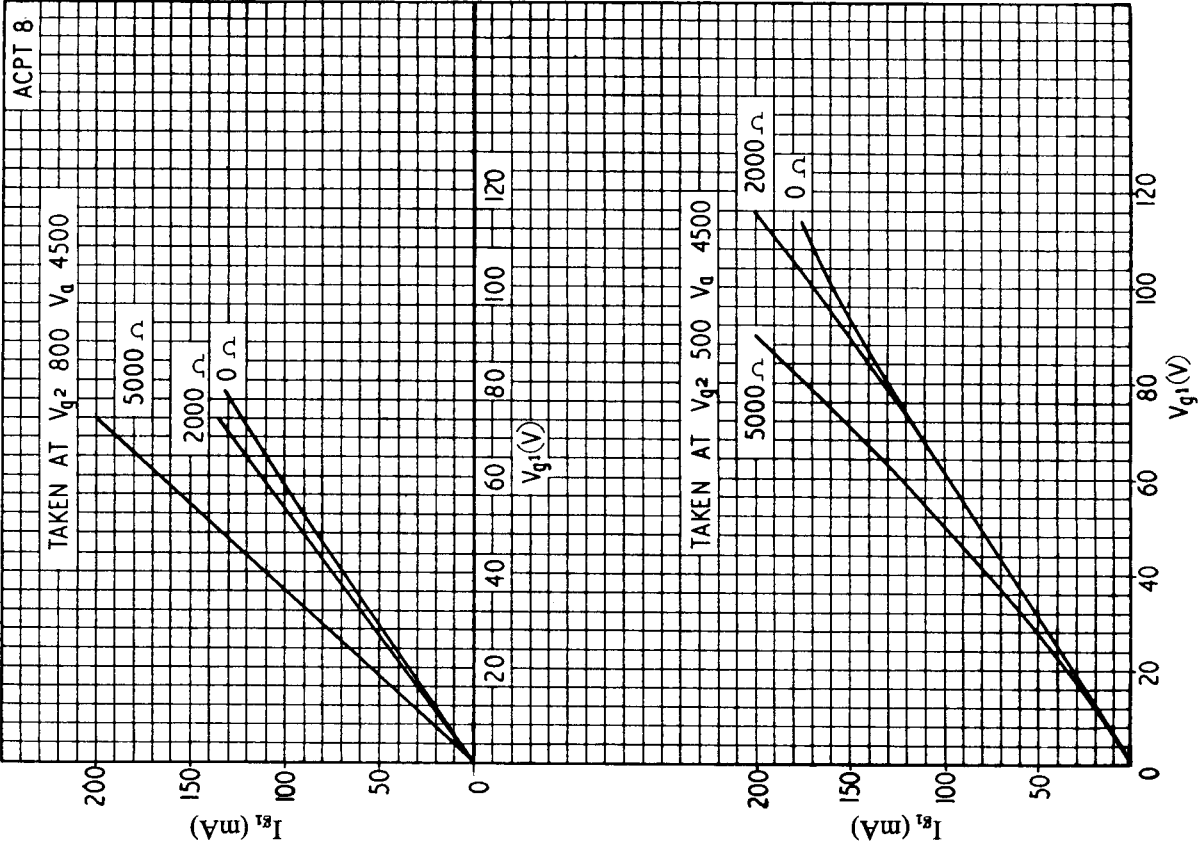

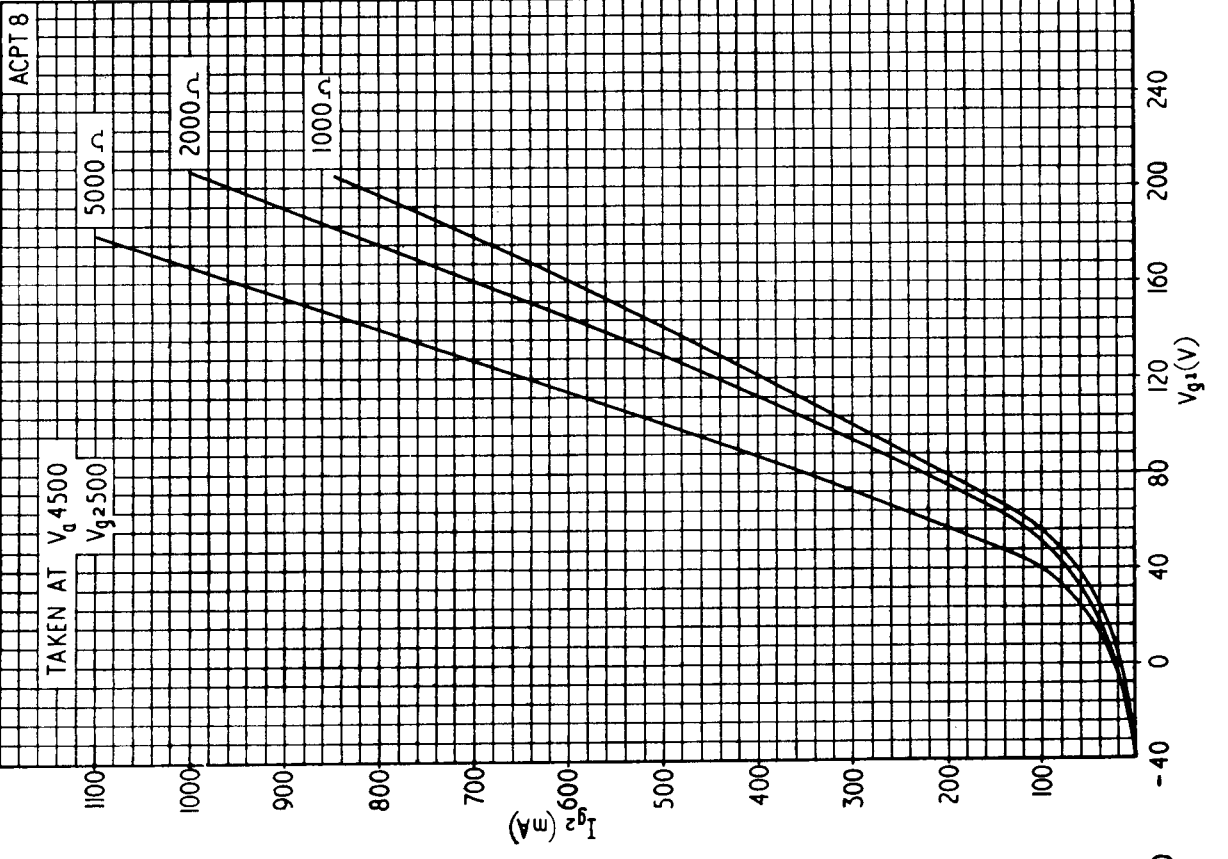
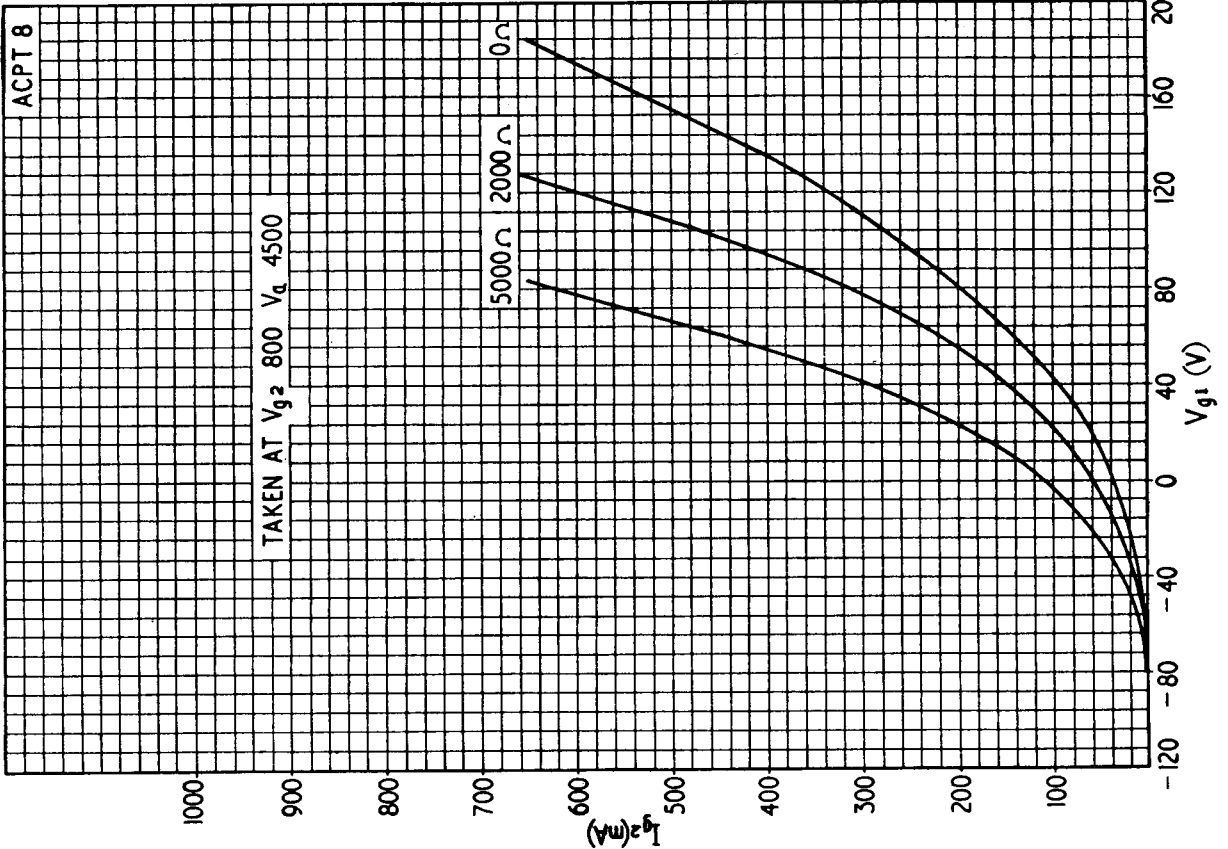

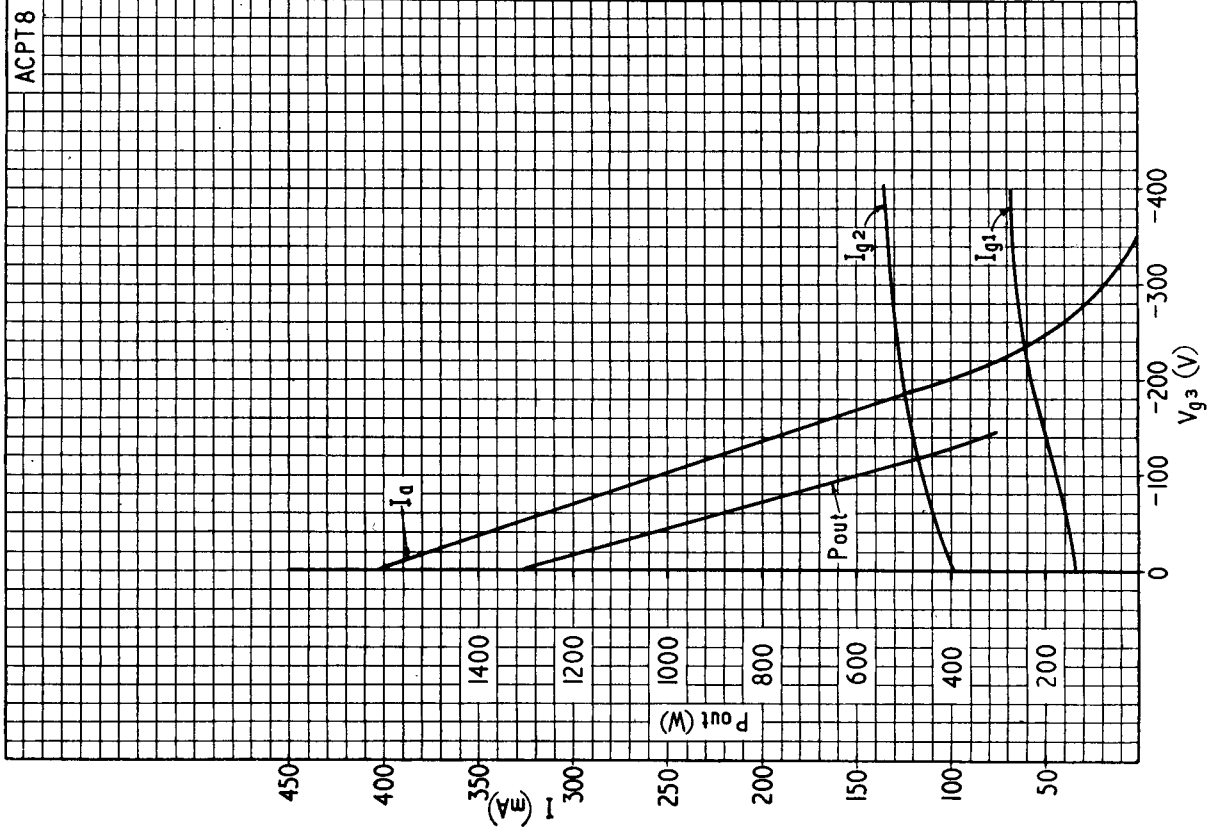

Taken at V_a 4,500, V_{g1} -120, V_{g2} via 30k Ω resistor.

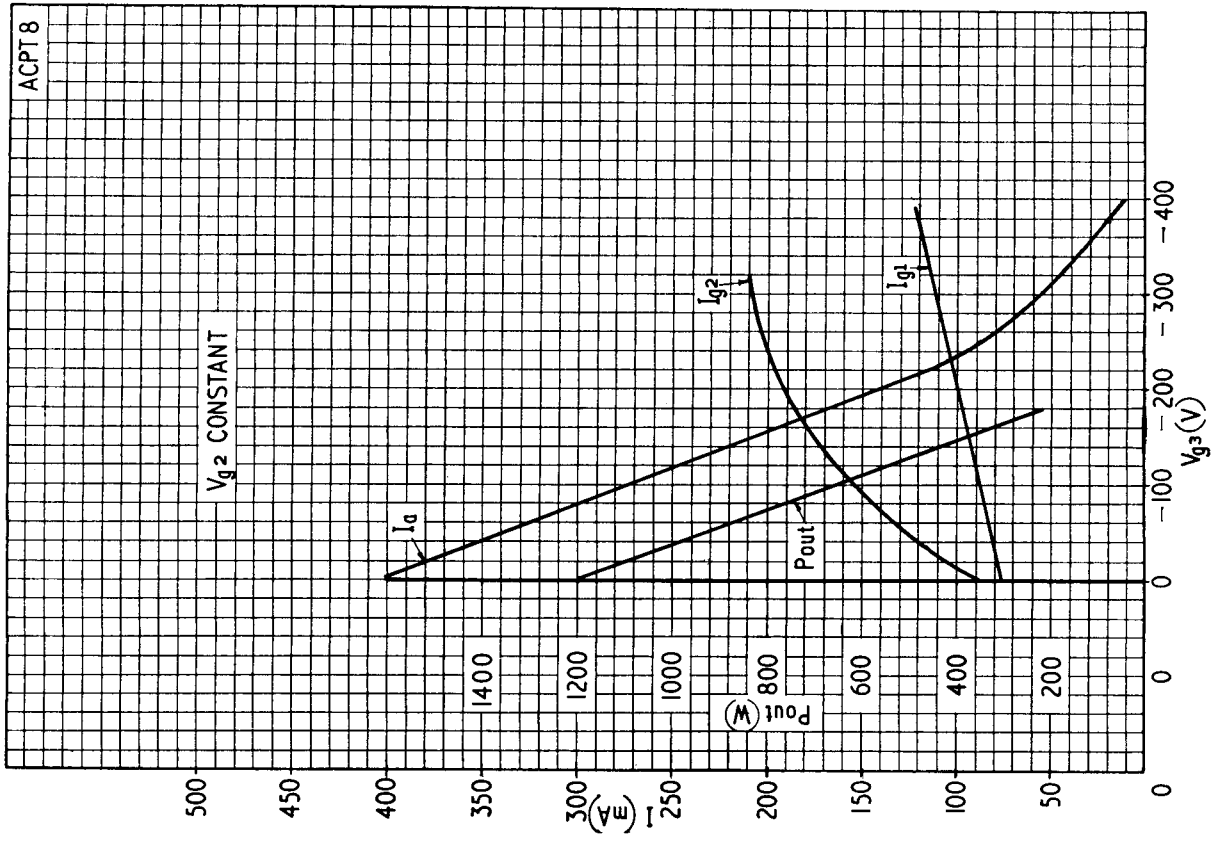

Taken at V_a 4,500, V_{g1} -120, V_{g2} (pk) 250, V_{g2} constant.

ACPT 8

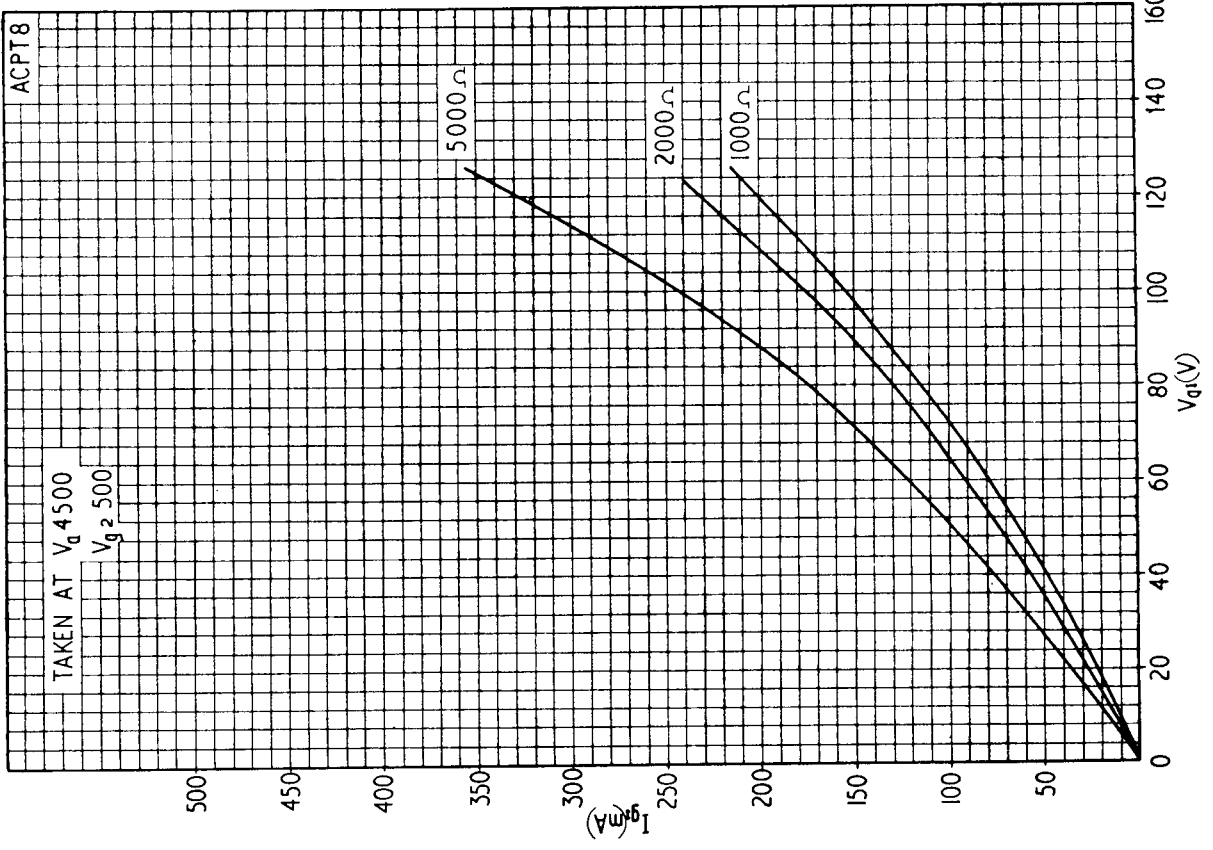

ACPT 8

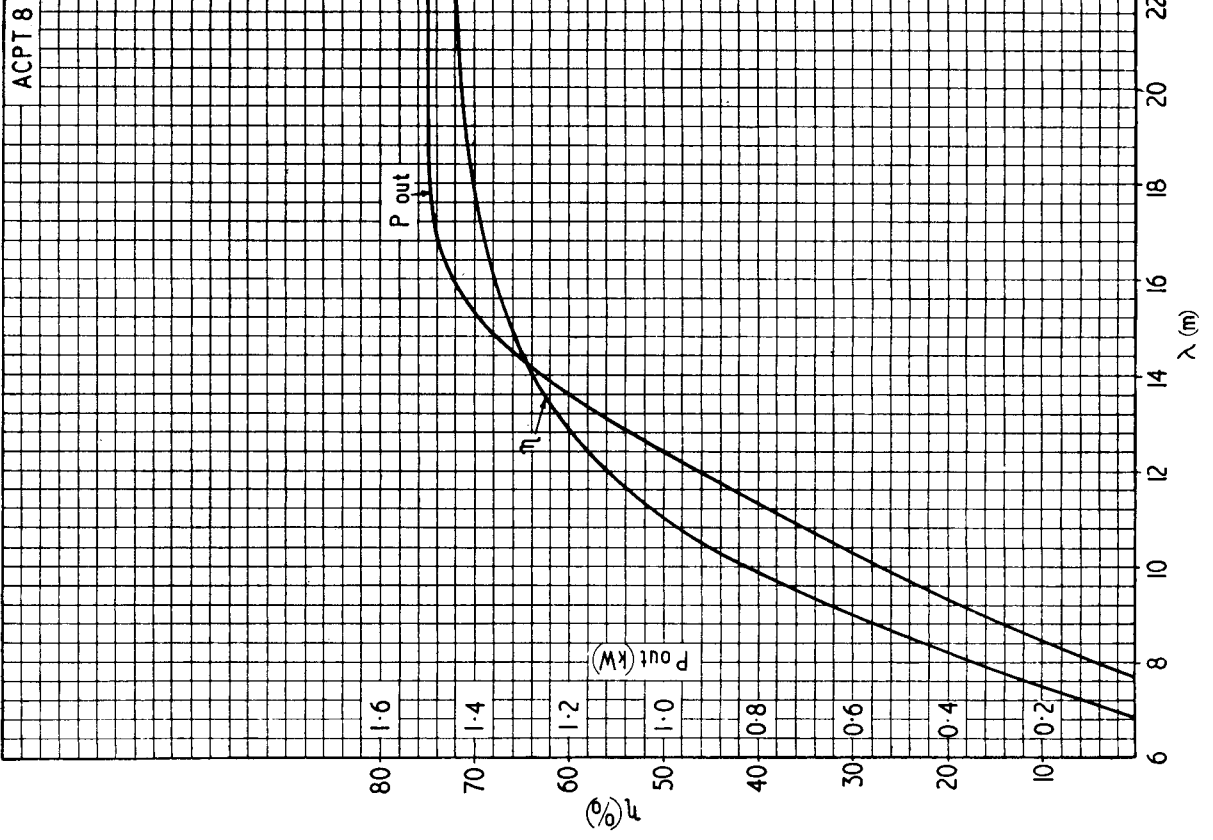



PRINTED IN ENGLAND