



Dual 1 Form A  
Solid State Relay

## DESCRIPTION

The AD4C331 is a bi-directional, double-pole, single-throw, normally open multipurpose solid-state relay. It is designed to replace electromechanical relays in general purpose switching applications. The relay consists of two integrated circuits, each driving a pair of rugged source-to-source enhancement type DMOS transistors. Each integrated circuit is optically coupled to a light emitting diode. The output MOS transistors are protected with free-wheeling diodes that can handle up to 1.5A of inrush current, making the relay ideal for switching lamps and highly inductive loads.

## FEATURES

- High input-to-output isolation
- Low input control power consumption
- 220mA maximum continuous load current
- 10 ohms maximum on-resistance
- Long life/high reliability

## APPLICATIONS

- Telecom switching
- Tip/Ring control
- PCMCIA modules
- Multiplexers
- Meter reading systems
- Data acquisition
- Medical equipment
- Battery monitoring
- Home/Safety security systems

## OPTIONS/SUFFIXES

- -S Surface Mount Option
- -TR Tape and Reel

## SCHEMATIC DIAGRAM

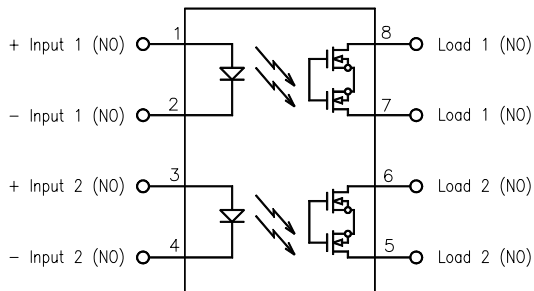

## MAXIMUM RATINGS

PARAMETER	UNIT	MIN	TYP	MAX
Storage Temperature	°C	-55		125
Operating Temperature	°C	-40		85
Continuous Input Current	mA			40
Transient Input Current	mA			400
Reverse Input Control Voltage	V	6		
Output Power Dissipation	mW			500

## APPROVALS

- BAPT PENDING
- CSA CERTIFICATE #LR111581-1
- UL FILE #E90096



Dual 1 Form A  
Solid State Relay

## ELECTRICAL CHARACTERISTICS - 25°

PARAMETER	UNIT	MIN	TYP	MAX	TEST CONDITIONS
<b>INPUT SPECIFICATIONS</b>					
LED Forward Voltage	V		1.2	1.5	If = 10mA
LED Reverse Voltage	V	6	12		Ir = 10uA
Turn-On Current	m A	5	2.5		Io = 220mA
Turn-Off Current	m A		0.5		
<b>OUTPUT SPECIFICATIONS</b>					
Blocking Voltage	V	250			Io = 10uA
Continuous Load Current	m A			220	If = 5mA
On-Resistance	Ω		6	10	Io = 220mA
Leakage Current	μ A		0.2	10	Vo = 250V
Output Capacitance	p F		25	50	Vo = 25V, f = 1.0MHz
Offset Voltage	m V			0.2	If = 5mA
<b>COUPLED SPECIFICATIONS</b>					
Isolation Voltage	V	2500			T = 1 minute
-H Suffix	V	3750			T = 1 minute
Turn-On Time	m s		2	5	If = 5mA, Io = 220mA
Turn-Off Time	m s		0.15	0.5	If = 5mA, Io = 220mA
Isolation Resistance	G Ω	100			
Coupled Capacitance	p F		2		
Contact Transient Ratio	V / μ s	2000	7000		dV = 50V



Dual 1 Form A  
Solid State Relay

PERFORMANCE DATA

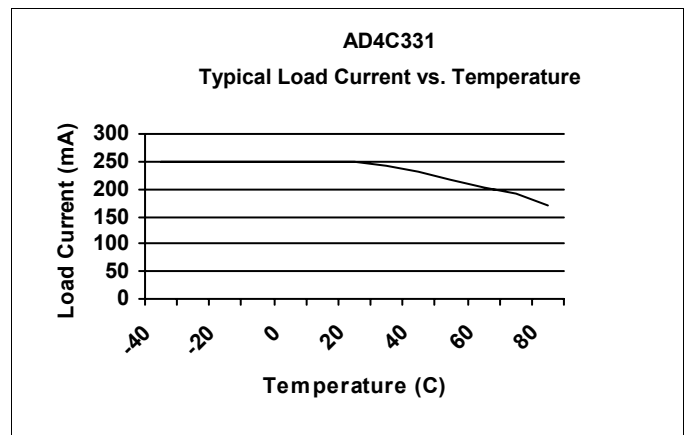
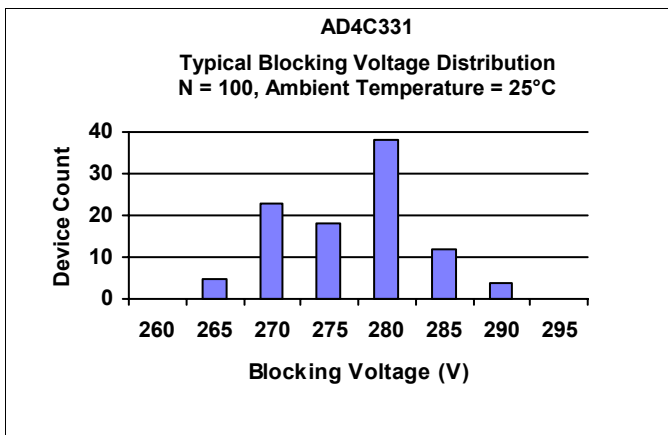
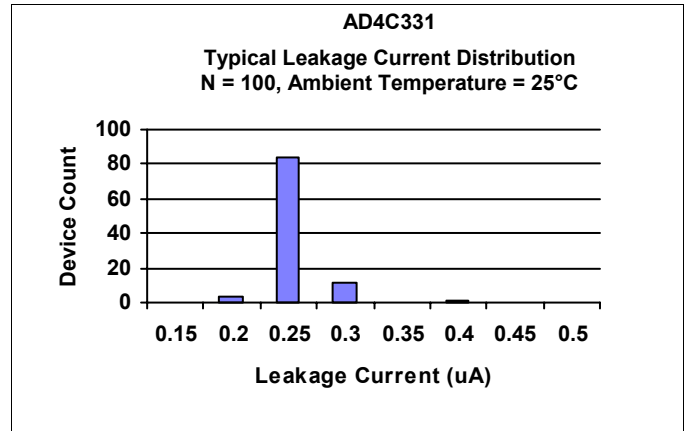
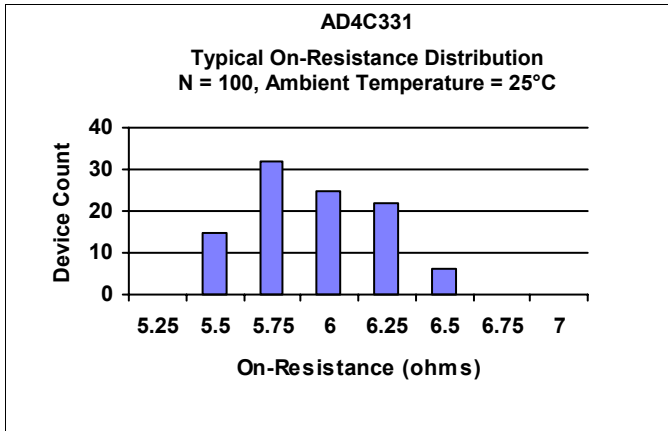
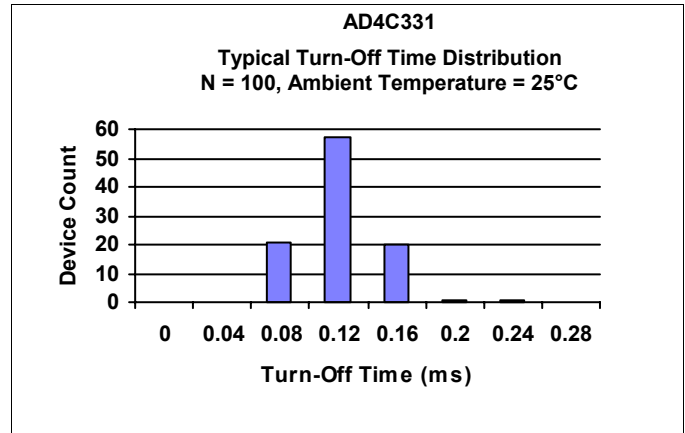
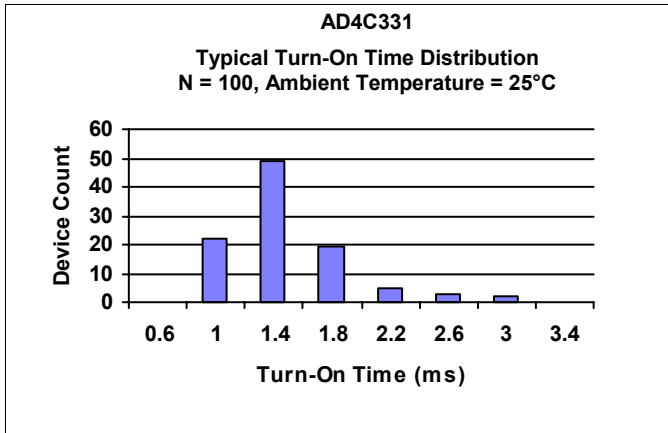



Dual 1 Form A  
Solid State Relay

**MECHANICAL DIMENSIONS**

**8 PIN DUAL IN-LINE PACKAGE**

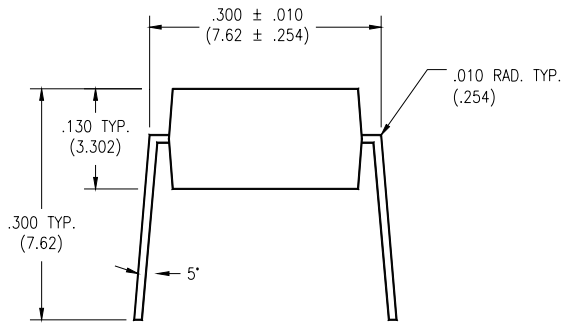

**END VIEW**

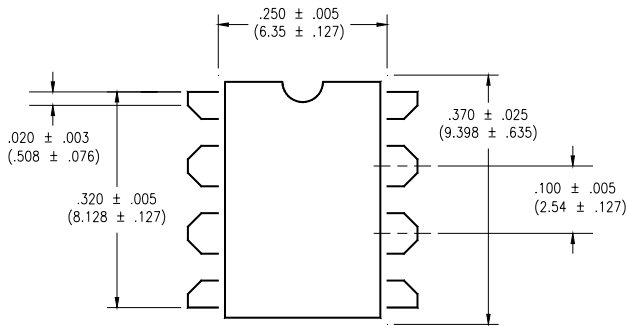

**TOP VIEW**

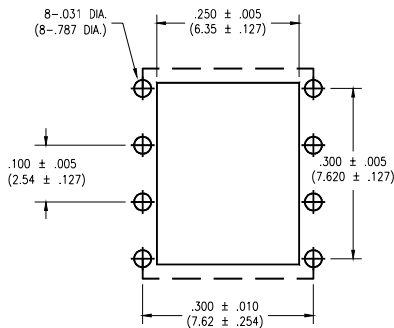

**BOTTOM VIEW/  
BOARD PATTERN**

**8 PIN SURFACE MOUNT DEVICE**

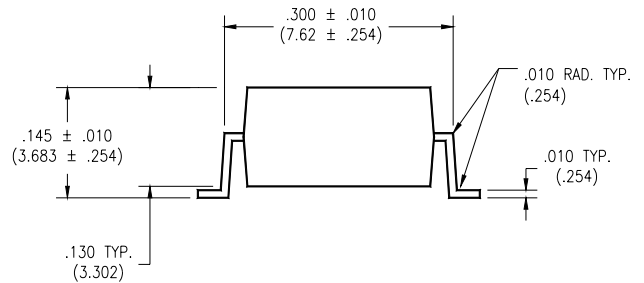

**END VIEW**

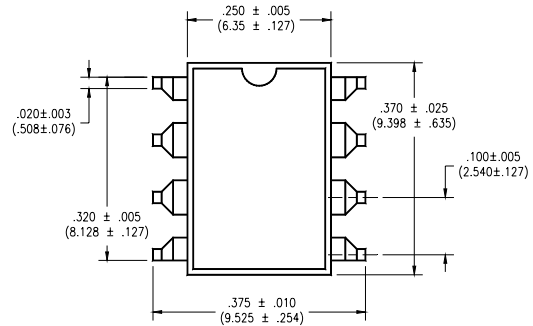

**TOP VIEW**

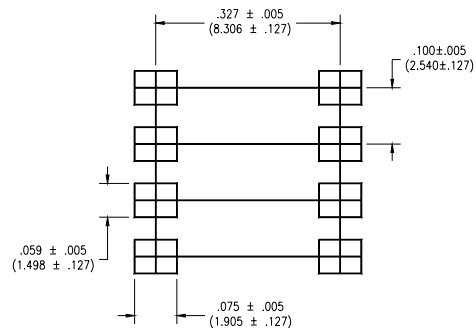

**BOTTOM VIEW/  
BOARD PATTERN**