

FEATURES

20 MHz maximum external clock rate
Second-order modulator
16 bits, no missing codes
±2 LSB INL typical at 16 bits
1 $\mu\text{V}/^\circ\text{C}$ typical offset drift
On-board digital isolator
On-board reference
±250 mV analog input range
Low power operation: 17 mA typical at 5.5 V
−40°C to +125°C operating range
16-lead SOIC package
Internal clock version: AD7400A
Safety and regulatory approvals
 UL recognition
 5000 V rms for 1 minute per UL 1577
 CSA Component Acceptance Notice #5A
 VDE Certificate of Conformity
 DIN V VDE V 0884-10 (VDE V 0884-10):2006-12
 $V_{\text{IORM}} = 891 \text{ V peak}$
Qualified for Automotive Applications

APPLICATIONS

AC motor controls
Shunt current monitoring
Data acquisition systems
Analog-to-digital and opto-isolator replacements

GENERAL DESCRIPTION

The AD7401A¹ is a second-order, sigma-delta (Σ - Δ) modulator that converts an analog input signal into a high speed, 1-bit data stream with on-chip digital isolation based on the Analog Devices, Inc., *iCoupler*[®] technology. The AD7401A operates from a 5 V power supply and accepts a pseudo-differential input signal of $\pm 250 \text{ mV}$ ($\pm 320 \text{ mV}$ full scale). The analog input is continuously sampled by the analog modulator, eliminating the need for external sample-and-hold circuitry. The input information is contained in the output stream as a density of ones with a data rate of up to 20 MHz. The original information can be reconstructed with an appropriate digital filter. The serial I/O can use a 5 V or a 3.3 V supply (V_{DD2}).

The serial interface is digitally isolated. High speed CMOS, combined with Analog Devices, Inc., *iCoupler*[®] technology, means the on-chip isolation provides outstanding performance characteristics, superior to alternatives such as optocoupler devices. The device contains an on-chip reference. The AD7401A is offered in a 16-lead SOIC and has an operating temperature range of -40°C to $+125^\circ\text{C}$.

FUNCTIONAL BLOCK DIAGRAM

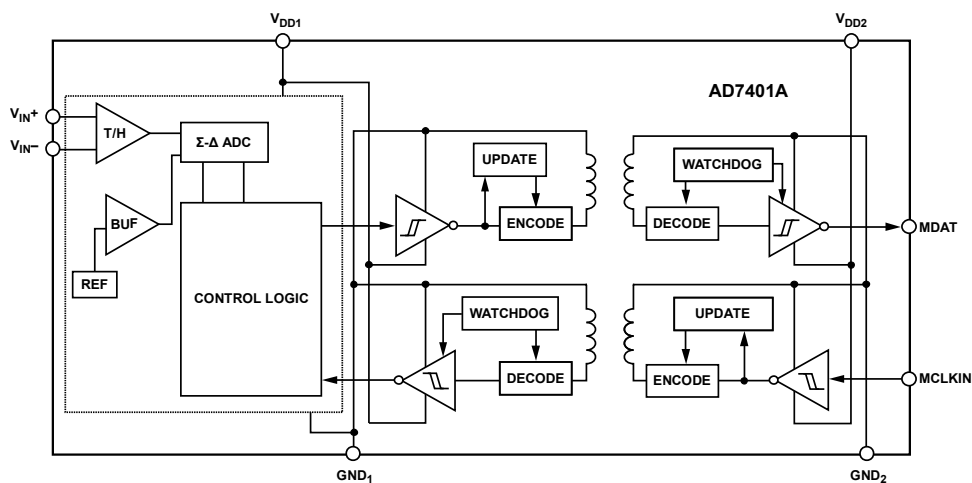

Figure 1.

¹ Protected by U.S. Patents 5,952,849; 6,873,065; and 7,075,329. Other patents pending.

TABLE OF CONTENTS

Features	1	Theory of Operation	14
Applications.....	1	Circuit Information.....	14
General Description	1	Analog Input	14
Functional Block Diagram	1	Differential Inputs	15
Revision History	2	Current Sensing Applications.....	15
Specifications.....	3	Voltage Sensing Applications.....	15
Timing Specifications	5	Digital Filter	16
Insulation and Safety-Related Specifications.....	6	Applications Information	18
Regulatory Information.....	6	Grounding and Layout	18
DIN V VDE V 0884-10 (VDE V 0884-10):2006-12 Insulation Characteristics	7	Evaluating the AD7401A Performance.....	18
Absolute Maximum Ratings.....	8	Insulation Lifetime.....	18
ESD Caution.....	8	Outline Dimensions	19
Pin Configuration and Function Descriptions.....	9	Ordering Guide	19
Typical Performance Characteristics	10	Automotive Product.....	19
Terminology	13		

REVISION HISTORY

1/2018—Rev. C to Rev. D

Changes to Features and General Description	1
Change to Power Dissipation Parameter, Table 1.....	4
Changes to Table 3 and Table 4.....	6
Changes to Absolute Maximum Rating Section.....	8
Changes to Table 8.....	9
Changes to Terminology Section.....	13
Changes to Ordering Guide	19
Added Automotive Product Section	19

7/2011—Rev. B to Rev. C

Changes to Minimum External Air Gap (Clearance) Parameter, Table 3 and Minimum External Tracking (Creepage) Parameter, Table 3	6
Changes to Figure 5; Pin 1 Description, Table 8; and Pin 7 Description, Table 8.....	9

3/2011—Rev. A to Rev. B

Change to General Description Section	1
Changes to Table 1.....	3

1/2011—Rev. 0 to Rev. A

Change to Features, UL Recognition Value	1
Change to Table 3, Input-to-Output Momentary Withstand Voltage Value.....	6
Changes to Table 4, Isolation Voltage Value, and Endnote 1.....	6

7/2008—Revision 0: Initial Version

SPECIFICATIONS

$V_{DD1} = 4.5\text{ V to }5.5\text{ V}$, $V_{DD2} = 3\text{ V to }5.5\text{ V}$, $V_{IN+} = -200\text{ mV to }+200\text{ mV}$, and $V_{IN-} = 0\text{ V}$ (single-ended); $T_A = -40^\circ\text{C to }+125^\circ\text{C}$, $f_{MCLKIN} = 16\text{ MHz maximum}$,¹ tested with sinc3 filter, 256 decimation rate, as defined by Verilog code, unless otherwise noted.

Table 1.

Parameter	Y Version ^{1,2}			Unit	Test Conditions/Comments
	Min	Typ	Max		
STATIC PERFORMANCE					
Resolution	16			Bits	Filter output truncated to 16 bits
Integral Nonlinearity (INL) ³		± 1.5	± 7	LSB	$V_{IN+} = \pm 200\text{ mV}$, $T_A = -40^\circ\text{C to }+85^\circ\text{C}$, $f_{MCLKIN} = 20\text{ MHz max}^1$
		± 2	± 13	LSB	$V_{IN+} = \pm 250\text{ mV}$, $T_A = -40^\circ\text{C to }+85^\circ\text{C}$, $f_{MCLKIN} = 20\text{ MHz max}^1$
		± 1.5	± 11	LSB	$V_{IN+} = \pm 200\text{ mV}$, $T_A = -40^\circ\text{C to }+125^\circ\text{C}$, $f_{MCLKIN} = 20\text{ MHz max}^1$
		± 2	± 46	LSB	$V_{IN+} = \pm 250\text{ mV}$, $T_A = -40^\circ\text{C to }+125^\circ\text{C}$, $f_{MCLKIN} = 20\text{ MHz max}^1$
Differential Nonlinearity (DNL) ³			± 0.9	LSB	Guaranteed no missed codes to 16 bits, $f_{MCLKIN} = 20\text{ MHz max}$, ¹ $V_{IN+} = -250\text{ mV to }+250\text{ mV}$
Offset Error ³		± 0.25	± 0.5	mV	$f_{MCLKIN} = 20\text{ MHz max}$, ¹ $V_{IN+} = -250\text{ mV to }+250\text{ mV}$
Offset Drift vs. Temperature ³		1	3.5	$\mu\text{V}/^\circ\text{C}$	
Offset Drift vs. V_{DD1} ³		120		$\mu\text{V}/\text{V}$	
Gain Error ³		0.07	± 1.5	mV	
		± 1		mV	$f_{MCLKIN} = 20\text{ MHz max}$, ¹ $V_{IN+} = -250\text{ mV to }+250\text{ mV}$
Gain Error Drift vs. Temperature ³		23		$\mu\text{V}/^\circ\text{C}$	
Gain Error Drift vs. V_{DD1} ³		110		$\mu\text{V}/\text{V}$	
ANALOG INPUT					
Input Voltage Range		± 200	± 250	mV	For specified performance; full range $\pm 320\text{ mV}$
Dynamic Input Current		± 13	± 18	μA	$V_{IN+} = 500\text{ mV}$, $V_{IN-} = 0\text{ V}$, $f_{MCLKIN} = 20\text{ MHz max}^1$
		± 10	± 15	μA	$V_{IN+} = 400\text{ mV}$, $V_{IN-} = 0\text{ V}$, $f_{MCLKIN} = 20\text{ MHz max}^1$
		0.08		μA	$V_{IN+} = 0\text{ V}$, $V_{IN-} = 0\text{ V}$, $f_{MCLKIN} = 20\text{ MHz max}^1$
DC Leakage Current		± 0.01	± 0.6	μA	
Input Capacitance		10		pF	
DYNAMIC SPECIFICATIONS					
Signal-to-(Noise + Distortion) Ratio (SINAD) ³	76	82		dB	$V_{IN+} = 5\text{ kHz}$ $V_{IN+} = \pm 200\text{ mV}$, $T_A = -40^\circ\text{C to }+85^\circ\text{C}$, $f_{MCLKIN} = 5\text{ MHz to }20\text{ MHz}^1$
	71	82		dB	$V_{IN+} = \pm 250\text{ mV}$, $T_A = -40^\circ\text{C to }+85^\circ\text{C}$, $f_{MCLKIN} = 5\text{ MHz to }20\text{ MHz}^1$
	72	82		dB	$V_{IN+} = \pm 200\text{ mV}$, $T_A = -40^\circ\text{C to }+125^\circ\text{C}$, $f_{MCLKIN} = 5\text{ MHz to }20\text{ MHz}^1$
		82		dB	$V_{IN+} = \pm 250\text{ mV}$, $T_A = -40^\circ\text{C to }+125^\circ\text{C}$, $f_{MCLKIN} = 5\text{ MHz to }20\text{ MHz}^1$
Signal-to-Noise Ratio (SNR) ³	81	83		dB	$V_{IN+} = \pm 250\text{ mV}$, $T_A = -40^\circ\text{C to }+125^\circ\text{C}$, $f_{MCLKIN} = 5\text{ MHz to }20\text{ MHz}^1$
	80	82		dB	$V_{IN+} = \pm 200\text{ mV}$, $T_A = -40^\circ\text{C to }+125^\circ\text{C}$, $f_{MCLKIN} = 5\text{ MHz to }20\text{ MHz}^1$
Total Harmonic Distortion (THD) ³		-90		dB	$f_{MCLKIN} = 20\text{ MHz max}^1$, $V_{IN+} = -250\text{ mV to }+250\text{ mV}$
Peak Harmonic or Spurious Noise (SFDR) ³		-92		dB	
Effective Number of Bits (ENOB) ³	12.3	13.3		Bits	
Isolation Transient Immunity ³	25	30		$\text{kV}/\mu\text{s}$	
LOGIC INPUTS					
Input High Voltage, V_{IH}	$0.8 \times V_{DD2}$			V	
Input Low Voltage, V_{IL}			$0.2 \times V_{DD2}$	V	
Input Current, I_{IN}			± 0.5	μA	
Floating State Leakage Current			1	μA	
Input Capacitance, C_{IN}^4			10	pF	

Parameter	Y Version ^{1,2}			Unit	Test Conditions/Comments
	Min	Typ	Max		
LOGIC OUTPUTS					
Output High Voltage, V_{OH}	$V_{DD2} - 0.1$			V	$I_O = -200 \mu A$
Output Low Voltage, V_{OL}			0.4	V	$I_O = +200 \mu A$
POWER REQUIREMENTS					
V_{DD1}	4.5		5.5	V	
V_{DD2}	3		5.5	V	
I_{DD1} ⁵		10	12	mA	$V_{DD1} = 5.5 V$
I_{DD2} ⁶		7	9	mA	$V_{DD2} = 5.5 V$
		3	4	mA	$V_{DD2} = 3.3 V$
POWER DISSIPATION (SEE Figure 17)		93.5		mW	$V_{DD1} = V_{DD2} = 5.5 V$

¹ For $f_{MCLK} > 16$ MHz to 20 MHz, mark space ratio is 48/52 to 52/48, $V_{DD1} = V_{DD2} = 5 V \pm 5\%$, and $T_A = -40^\circ C$ to $+85^\circ C$.

² All voltages are relative to their respective ground.

³ See the Terminology section.

⁴ Sample tested during initial release to ensure compliance.

⁵ See Figure 15.

⁶ See Figure 17.

TIMING SPECIFICATIONS

$V_{DD1} = 4.5\text{ V to }5.5\text{ V}$, $V_{DD2} = 3\text{ V to }5.5\text{ V}$, $T_A = -40^\circ\text{C to }+125^\circ\text{C}$, unless otherwise noted.

Table 2.

Parameter ¹	Limit at T_{MIN} , T_{MAX}	Unit	Description
$f_{MCLKIN}^{2, 3}$	20	MHz max	Master clock input frequency
	5	MHz min	Master clock input frequency
t_1^4	25	ns max	Data access time after MCLKIN rising edge
t_2^4	15	ns min	Data hold time after MCLKIN rising edge
t_3	$0.4 \times t_{MCLKIN}$	ns min	Master clock low time
t_4	$0.4 \times t_{MCLKIN}$	ns min	Master clock high time

¹ Sample tested during initial release to ensure compliance.

² Mark space ratio for clock input is 40/60 to 60/40 for $f_{MCLKIN} \leq 16\text{ MHz}$ and 48/52 to 52/48 for $16\text{ MHz} < f_{MCLKIN} < 20\text{ MHz}$.

³ $V_{DD1} = V_{DD2} = 5\text{ V} \pm 5\%$ for $f_{MCLKIN} > 16\text{ MHz}$ to 20 MHz .

⁴ Measured with the load circuit of Figure 2 and defined as the time required for the output to cross 0.8 V or 2.0 V.

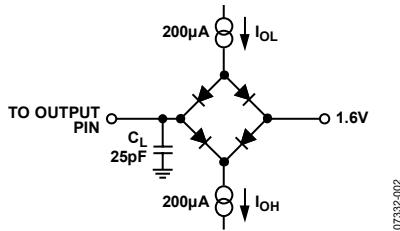

Figure 2. Load Circuit for Digital Output Timing Specifications

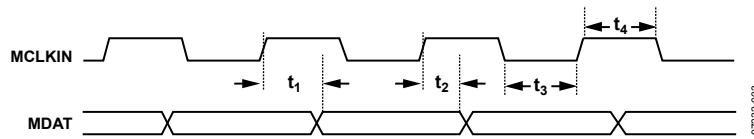

Figure 3. Data Timing

INSULATION AND SAFETY-RELATED SPECIFICATIONS

Table 3.

Parameter	Symbol	Value	Unit	Conditions
Input-to-Output Momentary Withstand Voltage	V_{ISO}	5000 min	V	1-minute duration
Minimum External Air Gap (Clearance)	L(I01)	7.8 min ^{1,2}	mm	Measured from input terminals to output terminals, shortest distance through air
Minimum External Tracking (Creepage)	L(I02)	7.8 min ^{1,2}	mm	Measured from input terminals to output terminals, shortest distance path along body
Minimum Internal Gap (Internal Clearance)		0.017 min	mm	Insulation distance through insulation
Tracking Resistance (Comparative Tracking Index)	CTI	> 400	V	DIN IEC 112/VDE 0303 Part 1 ³
Isolation Group		II		Material Group (DIN VDE 0110, 1/89, Table I) ³

¹ In accordance with IEC 60950-1 guidelines for the measurement of creepage and clearance distances for a pollution degree of 2 and altitudes ≤ 2000 m.

² Consideration must be given to pad layout to ensure the minimum required distance for clearance is maintained.

³ CSA CTI rating is >400 and a Material Group II isolation group.

REGULATORY INFORMATION

Table 4.

UL ¹	CSA	VDE ²
Recognized Under 1577 Component Recognition Program ¹	Approved under CSA Component Acceptance Notice #5A	Certified according to DIN V VDE V 0884-10 (VDE V 0884-10):2006-12 ²
5000 V rms Isolation Voltage	Basic insulation per CSA60950-1-07 and IEC 60950-1, 780 Vrms maximum working voltage. Reinforced insulation per CSA 60950-1-03 and IEC 60950-1, 390 V rms maximum working voltage	Reinforced insulation per DIN V VDE V 0884-10 (VDE V 0884-10):2006-12, 891 V peak
File E214100	File 205078	File 2471900-4880-0001

¹ In accordance with UL 1577, each AD7401A is proof tested by applying an insulation test voltage ≥ 6000 V rms for 1 second (current leakage detection limit = 15 μ A).

² In accordance with DIN V VDE V 0884-10, each AD7401A is proof tested by applying an insulation test voltage ≥ 1671 V peak for 1 sec (partial discharge detection limit = 5 pC).

DIN V VDE V 0884-10 (VDE V 0884-10):2006-12 INSULATION CHARACTERISTICS

This isolator is suitable for reinforced electrical isolation only within the safety limit data. Maintenance of the safety data is ensured by means of protective circuits.

Table 5.

Description	Symbol	Characteristic	Unit
INSTALLATION CLASSIFICATION PER DIN VDE 01 10 For Rated Mains Voltage ≤ 300 V rms For Rated Mains Voltage ≤ 450 V rms For Rated Mains Voltage ≤ 600 V rms		I to IV I to II I to II	
CLIMATIC CLASSIFICATION		40/105/21	
POLLUTION DEGREE (DIN VDE 01 10, TABLE 1)		2	
MAXIMUM WORKING INSULATION VOLTAGE	V_{IORM}	891	V peak
INPUT-TO-OUTPUT TEST VOLTAGE, METHOD B1 $V_{IORM} \times 1.875 = V_{PR}$, 100% Production Test, $t_m = 1$ sec, Partial Discharge < 5 pC	V_{PR}	1671	V peak
INPUT-TO-OUTPUT TEST VOLTAGE, METHOD A After Environmental Test Subgroup 1 $V_{IORM} \times 1.6 = V_{PR}$, $t_m = 60$ sec, Partial Discharge < 5 pC After Input and/or Safety Test Subgroup 2/ Safety Test Subgroup 3 $V_{IORM} \times 1.2 = V_{PR}$, $t_m = 60$ sec, Partial Discharge < 5 pC	V_{PR}	1426 1069	V peak V peak
HIGHEST ALLOWABLE OVERVOLTAGE (TRANSIENT OVERVOLTAGE, $t_{TR} = 10$ sec)	V_{TR}	6000	V peak
SAFETY-LIMITING VALUES (MAXIMUM VALUE ALLOWED IN THE EVENT OF A FAILURE, SEE Figure 4) Case Temperature Side 1 Current Side 2 Current	T_S I_{S1} I_{S2}	150 265 335	°C mA mA
INSULATION RESISTANCE AT T_S , $V_{IO} = 500$ V	R_S	>10 ⁹	Ω

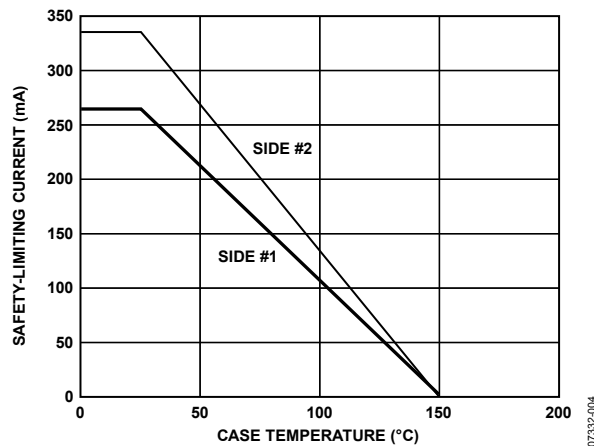

Figure 4. Thermal Derating Curve, Dependence of Safety-Limiting Values with Case Temperature per DIN V VDE V 0884-10

ABSOLUTE MAXIMUM RATINGS

$T_A = 25^\circ\text{C}$, unless otherwise noted. All voltages are relative to their respective grounds.

Table 6.

Parameter	Rating
V_{DD1} to GND_1	−0.3 V to +6.5 V
V_{DD2} to GND_2	−0.3 V to +6.5 V
Analog Input Voltage to GND_1	−0.3 V to $V_{DD1} + 0.3$ V
Digital Input Voltage to GND_2	−0.3 V to $V_{DD1} + 0.5$ V
Output Voltage to GND_2	−0.3 V to $V_{DD2} + 0.3$ V
Input Current to Any Pin Except Supplies ¹	±10 mA
Operating Temperature Range	−40°C to +125°C
Storage Temperature Range	−65°C to +150°C
Junction Temperature	150°C
SOIC Package	
θ_{JA} Thermal Impedance ²	89.2°C/W
θ_{JC} Thermal Impedance ²	55.6°C/W
Resistance (Input to Output), R_{I-O}	10 ¹² Ω
Capacitance (Input to Output), C_{I-O} ³	1.7 pF typ
Pb-Free Temperature, Soldering	
Reflow	260°C
ESD	1.5 kV

¹ Transient currents of up to 100 mA do not cause SCR to latch up.

² EDEC 252P standard board.

³ $f = 1$ MHz.

Stresses at or above those listed under Absolute Maximum Ratings may cause permanent damage to the product. This is a stress rating only; functional operation of the product at these or any other conditions above those indicated in the operational section of this specification is not implied. Operation beyond the maximum operating conditions for extended periods may affect product reliability.

Table 7. Maximum Continuous Working Voltage¹

Parameter	Max	Unit	Constraint
AC Voltage, Bipolar Waveform	565	V peak	50-year minimum lifetime
AC Voltage, Unipolar Waveform	891	V peak	Maximum CSA/VDE approved working voltage
DC Voltage	891	V	Maximum CSA/VDE approved working voltage

¹ Refers to continuous voltage magnitude imposed across the isolation barrier. See the Insulation Lifetime section for more details.

ESD CAUTION



ESD (electrostatic discharge) sensitive device.

Charged devices and circuit boards can discharge without detection. Although this product features patented or proprietary protection circuitry, damage may occur on devices subjected to high energy ESD. Therefore, proper ESD precautions should be taken to avoid performance degradation or loss of functionality.

PIN CONFIGURATION AND FUNCTION DESCRIPTIONS

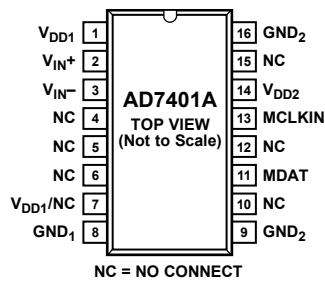

Figure 5. Pin Configuration

Table 8. Pin Function Descriptions

Pin No.	Mnemonic	Description
1	V _{DD1}	Supply Voltage, 4.5 V to 5.5 V. This is the supply voltage for the isolated side of the AD7401A and is relative to GND ₁ .
2	V _{IN+}	Positive Analog Input. Specified range of ± 250 mV.
3	V _{IN-}	Negative Analog Input. Normally connected to GND ₁ .
4 to 6, 10, 12, 15	NC	No Connect.
7	V _{DD1/NC}	Supply Voltage. Supply voltage (V _{DD1}) 4.5 V to 5.5 V. V _{DD1} is the supply voltage for the isolated side of the AD7401A and it is relative to GND ₁ . No Connect (NC). If desired, Pin 7 may be allowed to float. Do not tie Pin 7 to ground. The AD7401A will operate normally provided that the supply voltage is applied to Pin 1.
8	GND ₁	Ground 1. This is the ground reference point for all circuitry on the isolated side.
9, 16	GND ₂	Ground 2. This is the ground reference point for all circuitry on the nonisolated side.
11	MDAT	Serial Data Output. The single bit modulator output is supplied to this pin as a serial data stream. The bits are clocked out on the rising edge of the MCLKIN input and valid on the following MCLKIN rising edge.
13	MCLKIN	Master Clock Logic Input. 20 MHz maximum. The bit stream from the modulator is valid on the rising edge of MCLKIN.
14	V _{DD2}	Supply Voltage. 3 V to 5.5 V. This is the supply voltage for the nonisolated side and is relative to GND ₂ .

TYPICAL PERFORMANCE CHARACTERISTICS

T_A = 25°C, using 25 kHz brick-wall filter, unless otherwise noted.

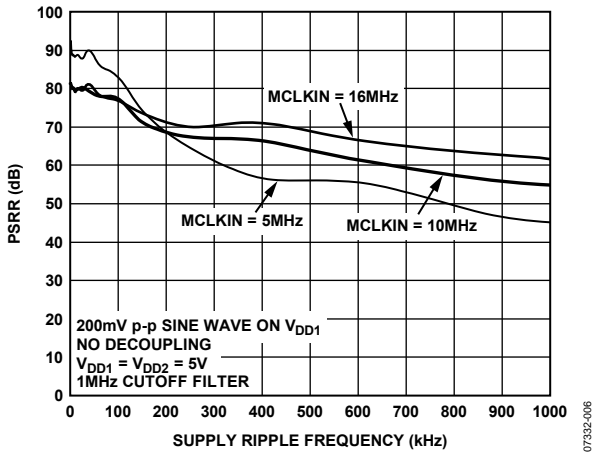

Figure 6. PSRR vs. Supply Ripple Frequency Without Supply Decoupling

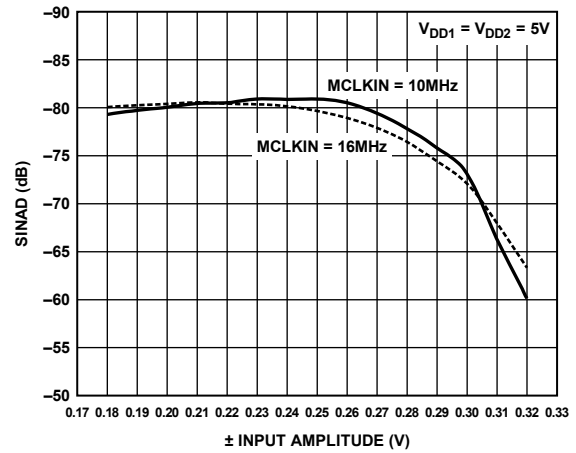

Figure 9. SINAD vs. V_{IN}

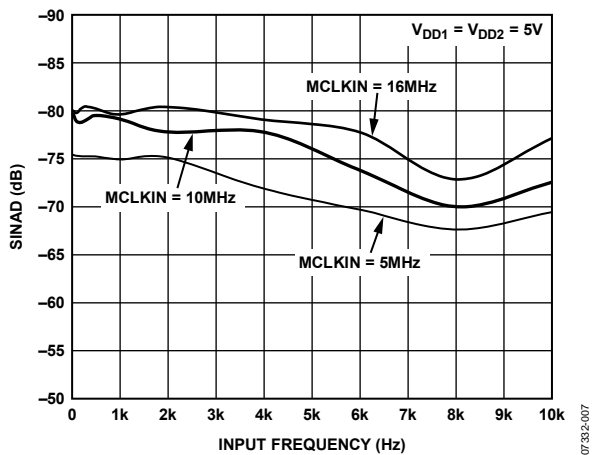

Figure 7. SINAD vs. Analog Input Frequency

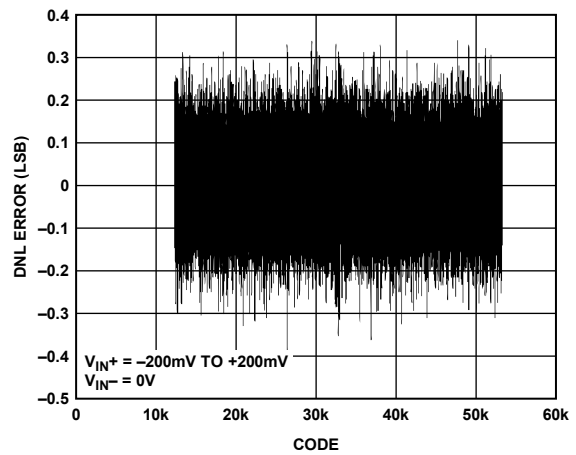

Figure 10. Typical DNL (±200 mV Range)

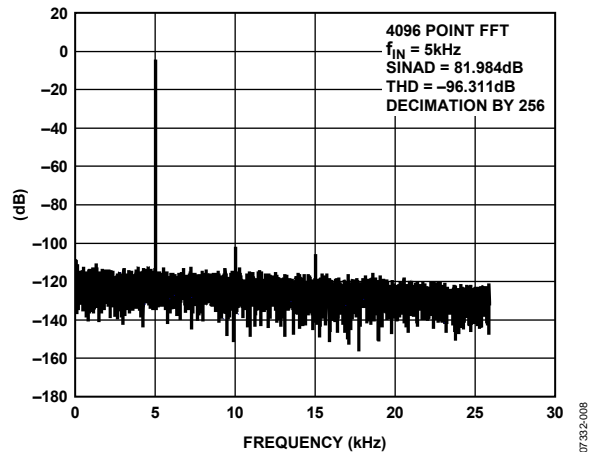

Figure 8. Typical FFT (±200 mV Range)

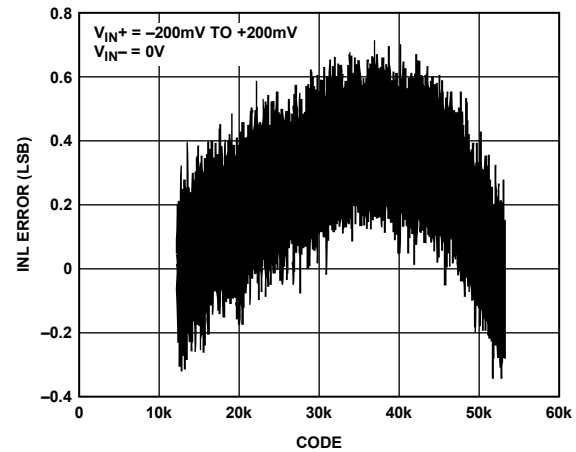

Figure 11. Typical INL (±200 mV Range)

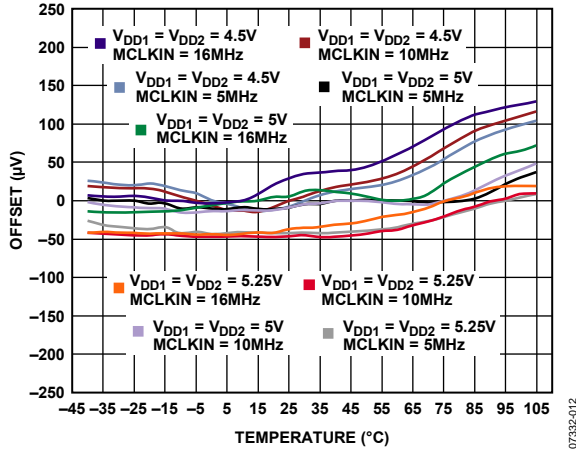

Figure 12. Offset Drift vs. Temperature for Various Supply Voltages

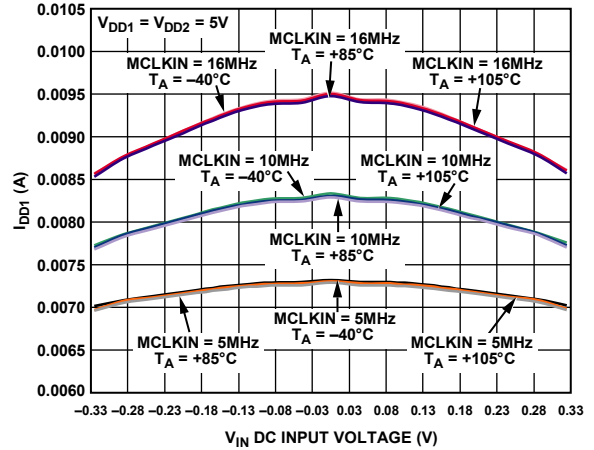

Figure 15. I_{DD1} vs. V_{IN} at Various Temperatures

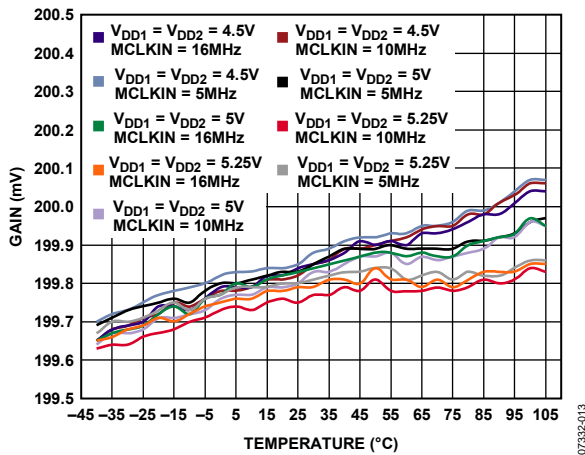

Figure 13. Gain Error Drift vs. Temperature for Various Supply Voltages

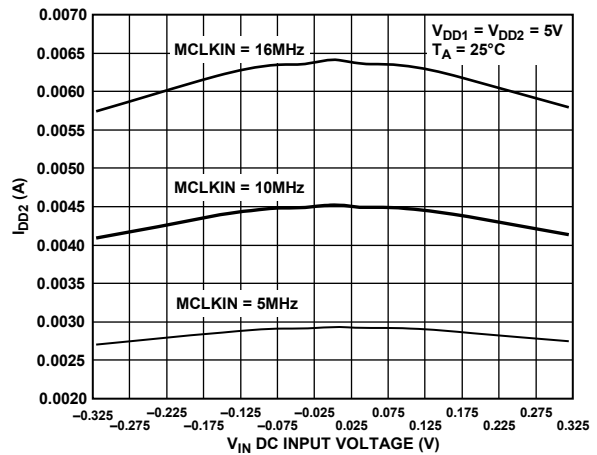

Figure 16. I_{DD2} vs. V_{IN} DC Input Voltage

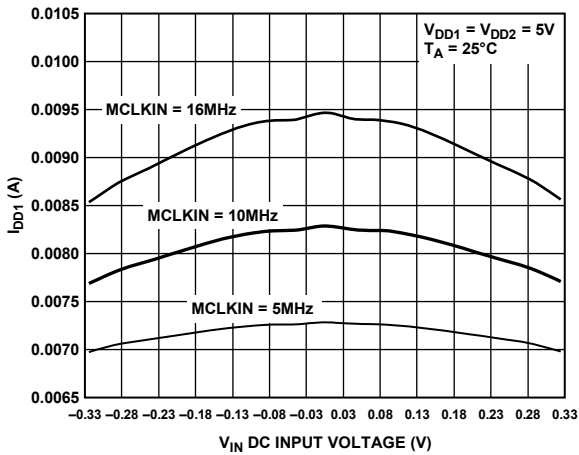

Figure 14. I_{DD1} vs. V_{IN} DC Input Voltage

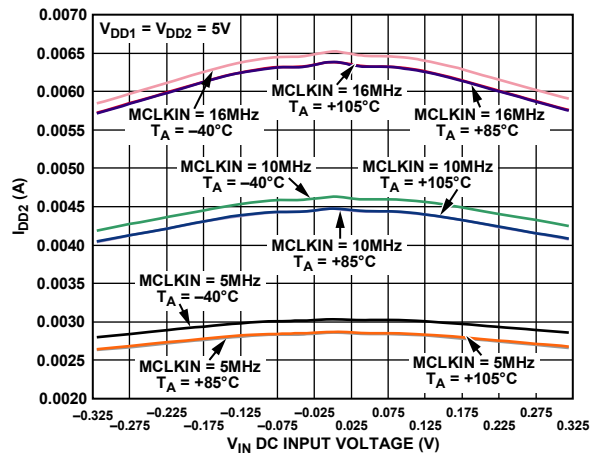

Figure 17. I_{DD2} vs. V_{IN} at Various Temperatures

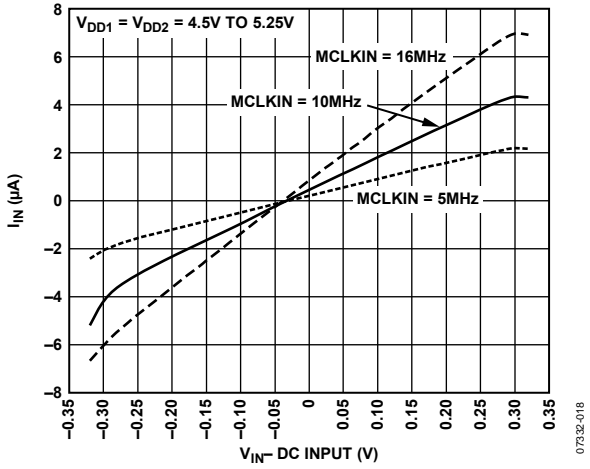

Figure 18. I_{IN} vs. V_{IN-DC} Input

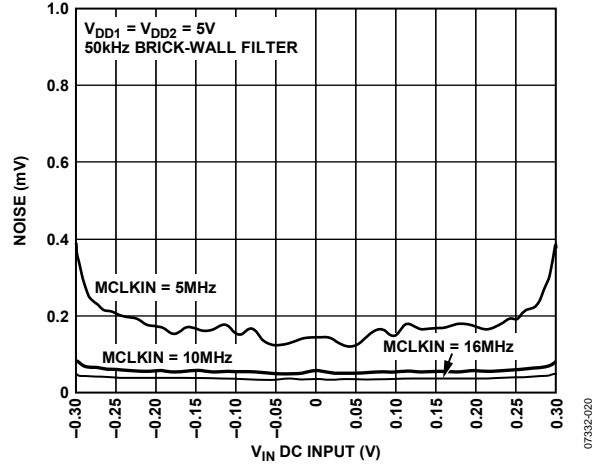

Figure 20. RMS Noise Voltage vs. V_{IN} DC Input

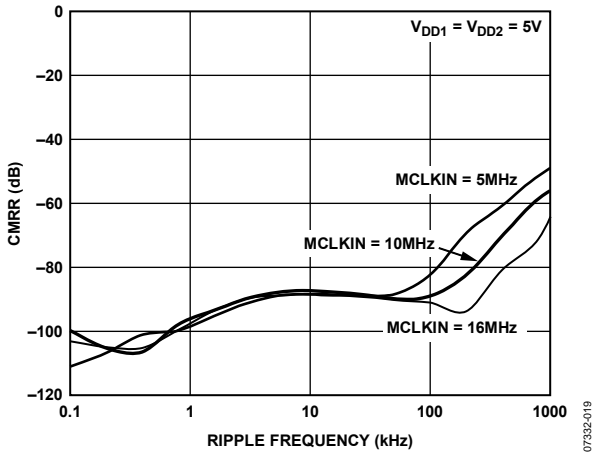

Figure 19. CMRR vs. Common-Mode Ripple Frequency

07332-016

07332-020

07332-019

TERMINOLOGY

Differential Nonlinearity (DNL)

DNL is the difference between the measured and the ideal 1 LSB change between any two adjacent codes in the ADC.

Integral Nonlinearity (INL)

INL is the maximum deviation from a straight line passing through the endpoints of the ADC transfer function. The endpoints of the transfer function are specified negative full scale, -250 mV ($V_{IN+} - V_{IN-}$), Code 7169 for the 16-bit level, and specified positive full scale, $+250\text{ mV}$ ($V_{IN+} - V_{IN-}$), Code 58366 for the 16-bit level.

Offset Error

Offset error is the deviation of the midscale code (32768 for the 16-bit level) from the ideal $V_{IN+} - V_{IN-}$ (that is, 0 V).

Offset Error Drift vs. Temperature

Offset error drift is a measure of the change in offset error with a change in temperature. It is expressed in $\mu\text{V}/^\circ\text{C}$.

Offset Error Drift vs. V_{DD1}

Offset error drift is a measure of the change in offset error with a change in supply voltage. It is expressed in $\mu\text{V}/\text{V}$.

Gain Error

The gain error includes both positive full-scale gain error and negative full-scale gain error. Positive full-scale gain error is the deviation of the specified positive full-scale code (58366 for the 16-bit level) from the ideal $V_{IN+} - V_{IN-}$ ($+250\text{ mV}$) after the offset error is adjusted out. Negative full-scale gain error is the deviation of the specified negative full-scale code (7169 for the 16-bit level) from the ideal $V_{IN+} - V_{IN-}$ (-250 mV) after the offset error is adjusted out. Gain error includes reference error.

Gain Error Drift vs. Temperature

Gain error drift is a measure of the change in gain error with a change in temperature. It is expressed in $\mu\text{V}/^\circ\text{C}$.

Gain Error Drift vs. V_{DD1}

Gain error drift is a measure of the change in gain error with a change in supply voltage. It is expressed in $\mu\text{V}/\text{V}$.

Signal-to-(Noise and Distortion) Ratio (SINAD)

SINAD is the measured ratio of signal-to-noise and distortion at the output of the ADC. The signal is the rms amplitude of the fundamental. Noise is the sum of all nonfundamental signals up to half the sampling frequency ($f_s/2$), excluding dc. The ratio is dependent on the number of quantization levels in the digitization process; the more levels, the smaller the quantization noise. The theoretical signal-to-(noise and distortion) ratio for an ideal N -bit converter with a sine wave input is given by

$$\text{Signal-to-(Noise and Distortion)} = (6.02N + 1.76)\text{ dB}$$

Therefore, for a 12-bit converter, this is 74 dB.

Effective Number of Bits (ENOB)

ENOB is defined by

$$\text{ENOB} = (\text{SINAD} - 1.76)/6.02\text{ bits}$$

Total Harmonic Distortion (THD)

THD is the ratio of the rms sum of harmonics to the fundamental. For the AD7401A, it is defined as

$$\text{THD(dB)} = 20\log\frac{\sqrt{V_2^2 + V_3^2 + V_4^2 + V_5^2 + V_6^2}}{V_1}$$

where:

V_1 is the rms amplitude of the fundamental.

$V_2, V_3, V_4, V_5,$ and V_6 are the rms amplitudes of the second through the sixth harmonics.

Peak Harmonic or Spurious Noise

Peak harmonic or spurious noise is defined as the ratio of the rms value of the next largest component in the ADC output spectrum (up to $f_s/2$, excluding dc) to the rms value of the fundamental. Normally, the value of this specification is determined by the largest harmonic in the spectrum, but for ADCs where the harmonics are buried in the noise floor, it is a noise peak.

Common-Mode Rejection Ratio (CMRR)

CMRR is defined as the ratio of the power in the ADC output at $\pm 250\text{ mV}$ frequency, f , to the power of a 250 mV p-p sine wave applied to the common-mode voltage of V_{IN+} and V_{IN-} of frequency, f_s , as

$$\text{CMRR (dB)} = 10 \cdot \log(P_f/P_{f_s})$$

where:

P_f is the power at frequency, f , in the ADC output.

P_{f_s} is the power at frequency, f_s , in the ADC output.

Power Supply Rejection Ratio (PSRR)

Variations in power supply affect the full-scale transition but not the linearity of the converter's linearity. PSRR is the maximum change in the specified full-scale ($\pm 250\text{ mV}$) transition point due to a change in power supply voltage from the nominal value (see Figure 6).

Isolation Transient Immunity

The isolation transient immunity specifies the rate of rise/fall of a transient pulse applied across the isolation boundary beyond which clock or data is corrupted. The AD7401A was tested using a transient pulse frequency of 100 kHz.

THEORY OF OPERATION

CIRCUIT INFORMATION

The AD7401A isolated Σ - Δ modulator converts an analog input signal into a high speed (20 MHz maximum), single-bit data stream; the time average single-bit data from the modulators is directly proportional to the input signal. Figure 23 shows a typical application circuit where the AD7401A is used to provide isolation between the analog input, a current sensing resistor, and the digital output, which is then processed by a digital filter to provide an N-bit word.

ANALOG INPUT

The differential analog input of the AD7401A is implemented with a switched capacitor circuit. This circuit implements a second-order modulator stage that digitizes the input signal into a 1-bit output stream. The sample clock (MCLKIN) provides the clock signal for the conversion process as well as the output data-framing clock. This clock source is external on the AD7401A. The analog input signal is continuously sampled by the modulator and compared to an internal voltage reference. A digital stream that accurately represents the analog input over time appears at the output of the converter (see Figure 21).

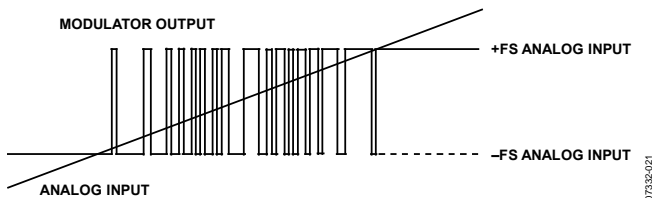

Figure 21. Analog Input vs. Modulator Output

A differential signal of 0 V results (ideally) in a stream of alternating 1s and 0s at the MDAT output pin. This output is high 50% of the time and low 50% of the time. A differential input of 200 mV produces a stream of 1s and 0s that are high 81.25% of the time (for a +250 mV input, the output stream is high 89.06% of the time). A differential input of -200 mV produces a stream of 1s and 0s that are high 18.75% of the time (for a -250 mV input, the output stream is high 10.94% of the time).

A differential input of 320 mV results in a stream of, ideally, all 1s. This is the absolute full-scale range of the AD7401A, and 200 mV is the specified full-scale range, as shown in Table 9.

Table 9. Analog Input Range

Analog Input	Voltage Input
Full-Scale Range	+640 mV
Positive Full Scale	+320 mV
Positive Typical Input Range	+250 mV
Positive Specified Input Range	+200 mV
Zero	0 mV
Negative Specified Input Range	-200 mV
Negative Typical Input Range	-250 mV
Negative Full Scale	-320 mV

To reconstruct the original information, this output needs to be digitally filtered and decimated. A sinc3 filter is recommended because this is one order higher than that of the AD7401A modulator. If a 256 decimation rate is used, the resulting 16-bit word rate is 62.5 kHz, assuming a 16 MHz external clock frequency. Figure 22 shows the transfer function of the AD7401A relative to the 16-bit output.

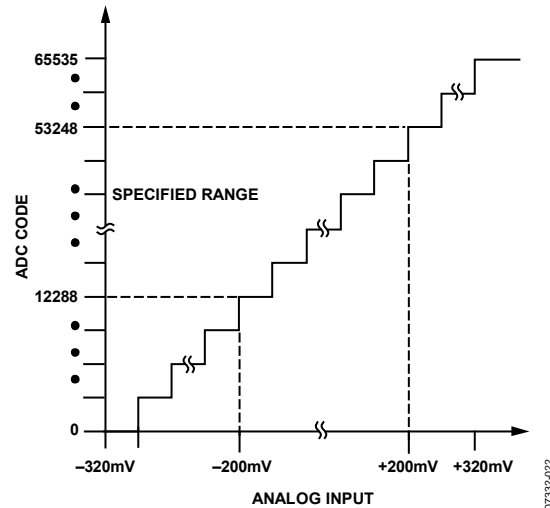

Figure 22. Filtered and Decimated 16-Bit Transfer Characteristic

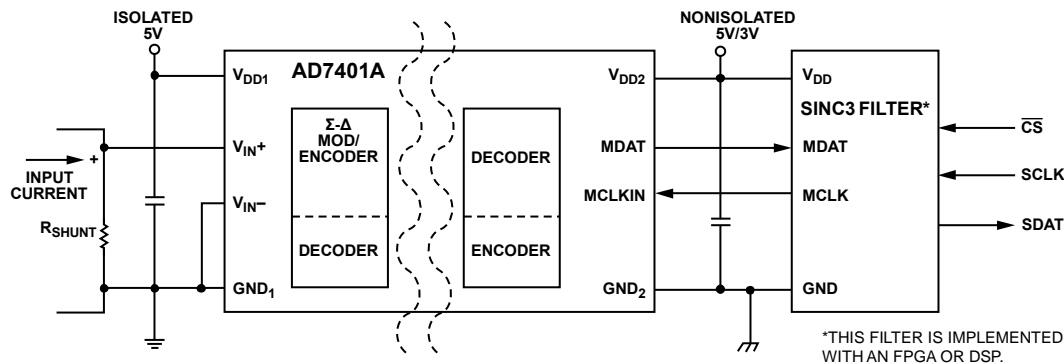

Figure 23. Typical Application Circuit

*THIS FILTER IS IMPLEMENTED WITH AN FPGA OR DSP.

DIFFERENTIAL INPUTS

The analog input to the modulator is a switched capacitor design. The analog signal is converted into charge by highly linear sampling capacitors. A simplified equivalent circuit diagram of the analog input is shown in Figure 24. A signal source driving the analog input must be able to provide the charge onto the sampling capacitors every half MCLKIN cycle and settle to the required accuracy within the next half cycle.

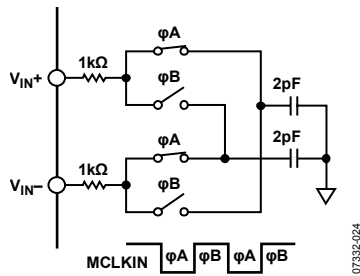

Figure 24. Analog Input Equivalent Circuit

Because the AD7401A samples the differential voltage across its analog inputs, low noise performance is attained with an input circuit that provides low common-mode noise at each input. The amplifiers used to drive the analog inputs play a critical role in attaining the high performance available from the AD7401A.

When a capacitive load is switched onto the output of an op amp, the amplitude momentarily drops. The op amp tries to correct the situation and, in the process, hits its slew rate limit. This nonlinear response, which can cause excessive ringing, can lead to distortion. To remedy the situation, a low-pass RC filter can be connected between the amplifier and the input to the AD7401A. The external capacitor at each input aids in supplying the current spikes created during the sampling process, and the resistor isolates the op amp from the transient nature of the load.

The recommended circuit configuration for driving the differential inputs to achieve best performance is shown in Figure 25. A capacitor between the two input pins sources or sinks charge to allow most of the charge that is needed by one input to be effectively supplied by the other input. The series resistor again isolates any op amp from the current spikes created during the sampling process. Recommended values for the resistors and capacitor are 22 Ω and 47 pF, respectively.

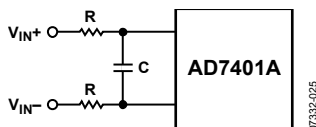

Figure 25. Differential Input RC Network

CURRENT SENSING APPLICATIONS

The AD7401A is ideally suited for current sensing applications where the voltage across a shunt resistor is monitored. The load current flowing through an external shunt resistor produces a voltage at the input terminals of the AD7401A. The AD7401A provides isolation between the analog input from the current sensing resistor and the digital outputs. By selecting the appropriate shunt resistor value, a variety of current ranges can be monitored.

Choosing R_{SHUNT}

The shunt resistor values used in conjunction with the AD7401A are determined by the specific application requirements in terms of voltage, current, and power. Small resistors minimize power dissipation, while low inductance resistors prevent any induced voltage spikes, and good tolerance devices reduce current variations. The final values chosen are a compromise between low power dissipation and good accuracy. Low value resistors have less power dissipated in them, but higher value resistors may be required to utilize the full input range of the ADC, thus achieving maximum SNR performance.

When the peak sense current is known, the voltage range of the AD7401A (± 200 mV) is divided by the maximum sense current to yield a suitable shunt value. If the power dissipation in the shunt resistor is too large, the shunt resistor can be reduced and less of the ADC input range is used. Using less of the ADC input range results in performance that is more susceptible to noise and offset errors because offset errors are fixed and are thus more significant when smaller input ranges are used.

R_{SHUNT} must be able to dissipate the I^2R power losses. If the power dissipation rating of the resistor is exceeded, its value may drift or the resistor may be damaged, resulting in an open circuit. This can result in a differential voltage across the terminals of the AD401A in excess of the absolute maximum ratings. If I_{SENSE} has a large high frequency component, take care to choose a resistor with low inductance.

VOLTAGE SENSING APPLICATIONS

The AD7401A can also be used for isolated voltage monitoring. For example, in motor control applications, it can be used to sense bus voltage. In applications where the voltage being monitored exceeds the specified analog input range of the AD7401A, a voltage divider network can be used to reduce the voltage to be monitored to the required range.

DIGITAL FILTER

The overall system resolution and throughput rate is determined by the filter selected and the decimation rate used. The higher the decimation rate, the greater the system accuracy, as illustrated in Figure 26. However, there is a tradeoff between accuracy and throughput rate and, therefore, higher decimation rates result in lower throughput solutions. Note that for a given bandwidth requirement, a higher MCLKIN frequency can allow for higher decimation rates to be used, resulting in higher SNR performance.

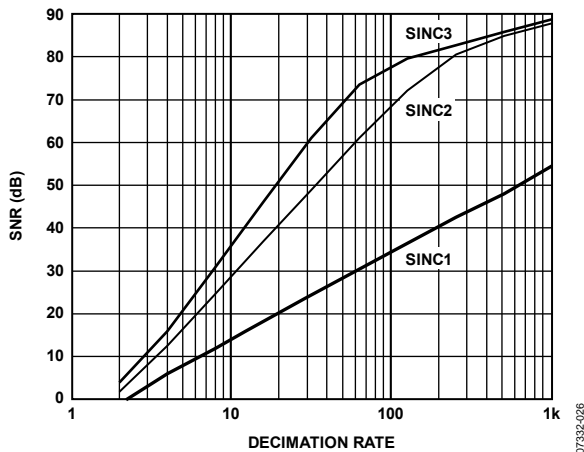

Figure 26. SNR vs. Decimation Rate for Different Filter Types

A sinc3 filter is recommended for use with the AD7401A. This filter can be implemented on an FPGA or a DSP.

$$H(z) = \left(\frac{1 - Z^{DR}}{1 - Z^{-1}} \right)^3$$

where DR is the decimation rate.

The following Verilog code provides an example of a sinc3 filter implementation on a Xilinx® Spartan-II 2.5 V FPGA. This code can possibly be compiled for another FPGA, such as an Altera® device. Note that the data is read on the negative clock edge in this case, although it can be read on the positive edge, if preferred.

```

/*`Data is read on negative clk edge*/
module DEC256SINC24B(mdata1, mclk1, reset,
DATA);
input mclk1;          /*used to clk filter*/
input reset;         /*used to reset filter*/
input mdata1;        /*ip data to be
filtered*/
output [15:0] DATA; /*filtered op*/
integer location;
integer info_file;

reg [23:0] ip_data1;
reg [23:0] acc1;
reg [23:0] acc2;
reg [23:0] acc3;
reg [23:0] acc3_d1;
reg [23:0] acc3_d2;
reg [23:0] diff1;
reg [23:0] diff2;
reg [23:0] diff3;
reg [23:0] diff1_d;
reg [23:0] diff2_d;
reg [15:0] DATA;
reg [7:0] word_count;
reg word_clk;
reg init;

```

```

/*Perform the Sinc ACTION*/
always @ (mdata1)
if(mdata1==0)
    ip_data1 <= 0; /* change from a 0
to a -1 for 2's comp */
else
    ip_data1 <= 1;

/*ACCUMULATOR (INTEGRATOR)
Perform the accumulation (IIR) at the speed
of the modulator.

```

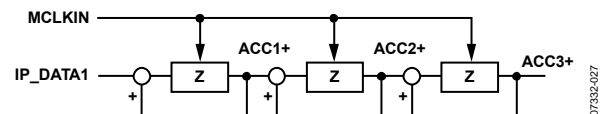

Figure 27. Accumulator

```

Z = one sample delay
MCLKOUT = modulators conversion bit rate
*/

always @ (posedge mclk1 or posedge reset)
if (reset)
begin
/*initialize acc registers on reset*/
acc1 <= 0;
acc2 <= 0;
acc3 <= 0;
end
else
begin
/*perform accumulation process*/
acc1 <= acc1 + ip_data1;
acc2 <= acc2 + acc1;
acc3 <= acc3 + acc2;
end

/*DECIMATION STAGE (MCLKOUT/ WORD_CLK)
*/
always @ (negedge mclk1 or posedge reset)
if (reset)
word_count <= 0;
else
word_count <= word_count + 1;

always @ (word_count)
word_clk <= word_count[7];

/*DIFFERENTIATOR ( including decimation
stage)
Perform the differentiation stage (FIR) at a
lower speed.

```

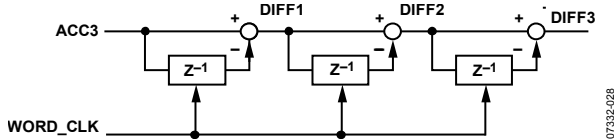

Figure 28. Differentiator

07332-028

```

Z = one sample delay
WORD_CLK = output word rate
*/

always @ (posedge word_clk or posedge reset)
if(reset)
begin
acc3_d2 <= 0;
diff1_d <= 0;
diff2_d <= 0;
diff1 <= 0;
diff2 <= 0;
diff3 <= 0;
end

else
begin
diff1 <= acc3 - acc3_d2;
diff2 <= diff1 - diff1_d;
diff3 <= diff2 - diff2_d;
acc3_d2 <= acc3;
diff1_d <= diff1;
diff2_d <= diff2;
end

/* Clock the Sinc output into an output
register

```

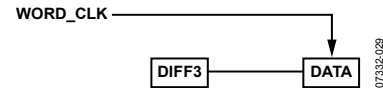

Figure 29. Clocking Sinc Output into an Output Register

07332-028

```

WORD_CLK = output word rate
*/

always @ (posedge word_clk)
begin
DATA[15] <= diff3[23];
DATA[14] <= diff3[22];
DATA[13] <= diff3[21];
DATA[12] <= diff3[20];
DATA[11] <= diff3[19];
DATA[10] <= diff3[18];
DATA[9] <= diff3[17];
DATA[8] <= diff3[16];
DATA[7] <= diff3[15];
DATA[6] <= diff3[14];
DATA[5] <= diff3[13];
DATA[4] <= diff3[12];
DATA[3] <= diff3[11];
DATA[2] <= diff3[10];
DATA[1] <= diff3[9];
DATA[0] <= diff3[8];
end
endmodule

```

APPLICATIONS INFORMATION

GROUNDING AND LAYOUT

Supply decoupling with a value of 100 nF is recommended on both V_{DD1} and V_{DD2} . In applications involving high common-mode transients, care should be taken to ensure that board coupling across the isolation barrier is minimized. Furthermore, the board layout should be designed so that any coupling that occurs equally affects all pins on a given component side. Failure to ensure this may cause voltage differentials between pins to exceed the absolute maximum ratings of the device, thereby leading to latch-up or permanent damage. Any decoupling used should be placed as close to the supply pins as possible.

Series resistance in the analog inputs should be minimized to avoid any distortion effects, especially at high temperatures. If possible, equalize the source impedance on each analog input to minimize offset. Beware of mismatch and thermocouple effects on the analog input PCB tracks to reduce offset drift.

EVALUATING THE AD7401A PERFORMANCE

An AD7401A evaluation board is available with split ground planes and a board split beneath the AD7401A package to ensure isolation. This board allows access to each pin on the device for evaluation purposes.

The evaluation board package includes a fully assembled and tested evaluation board, documentation, and software for controlling the board from the PC via the EVAL-CED1Z. The software also includes a sinc3 filter implemented on an FPGA. The evaluation board is used in conjunction with the EVAL-CED1Z board and can also be used as a standalone board. The software allows the user to perform ac (fast Fourier transform) and dc (histogram of codes) tests on the AD7401A. The software and documentation are on a CD that is shipped with the evaluation board.

INSULATION LIFETIME

All insulation structures, subjected to sufficient time and/or voltage, are vulnerable to breakdown. In addition to the testing performed by the regulatory agencies, Analog Devices has carried out an extensive set of evaluations to determine the lifetime of the insulation structure within the AD7401A.

These tests subjected devices to continuous cross-isolation voltages. To accelerate the occurrence of failures, the selected test voltages were values exceeding those of normal use. The time-to-failure values of these units were recorded and used to calculate acceleration factors. These factors were then used to calculate the time-to-failure under normal operating conditions. The values shown in Table 7 are the lesser of the following two values:

- The value that ensures at least a 50-year lifetime of continuous use.
- The maximum CSA/VDE approved working voltage.

It should also be noted that the lifetime of the AD7401A varies according to the waveform type imposed across the isolation barrier. The *iCoupler* insulation structure is stressed differently depending on whether the waveform is bipolar ac, unipolar ac, or dc. Figure 30, Figure 31, and Figure 32 illustrate the different isolation voltage waveforms.

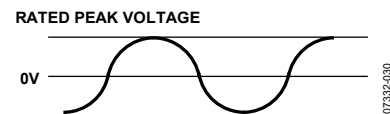

Figure 30. Bipolar AC Waveform

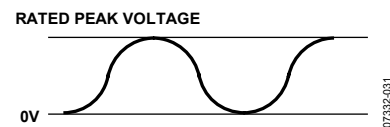

Figure 31. Unipolar AC Waveform

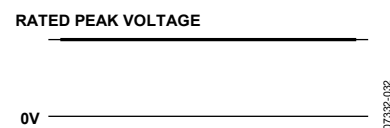
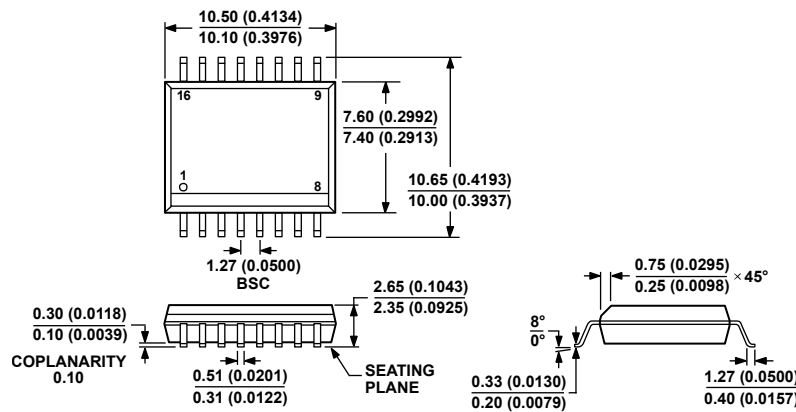

Figure 32. DC Waveform

OUTLINE DIMENSIONS



COMPLIANT TO JEDEC STANDARDS MS-013-AA
 CONTROLLING DIMENSIONS ARE IN MILLIMETERS; INCH DIMENSIONS
 (IN PARENTHESES) ARE ROUNDED-OFF MILLIMETER EQUIVALENTS FOR
 REFERENCE ONLY AND ARE NOT APPROPRIATE FOR USE IN DESIGN.

03-27-2007-B

Figure 33. 16-Lead Standard Small Outline Package [SOIC_W]
 Wide Body
 (RW-16)

Dimensions shown in millimeters and (inches)

ORDERING GUIDE

Model ¹	Temperature Range	Package Description	Package Option
AD7401AYRWZ	-40°C to +125°C	16-Lead Standard Small Outline Package (SOIC_W)	RW-16
AD7401AYRWZ-RL	-40°C to +125°C	16-Lead Standard Small Outline Package (SOIC_W)	RW-16
ADW70015Z-ORL	-40°C to +125°C	16-Lead Standard Small Outline Package (SOIC_W)	RW-16
EVAL-AD7401AEDZ		Evaluation Board	
EVAL-CED1Z		Development Board	

¹ Z = RoHS Compliant Part.

AUTOMOTIVE PRODUCT

The ADW70015Z model is available with controlled manufacturing to support the quality and reliability requirements of automotive applications. Note that this automotive model may have specifications that differ from the commercial models; therefore, designers should review the Specifications section of this data sheet carefully. Only the automotive grade product shown is available for use in automotive applications. Contact your local Analog Devices account representative for specific product ordering information and to obtain the specific Automotive Reliability reports for this model.

NOTES