

FEATURES

Ideal for current shunt applications

High common-mode voltage range

–2 V to +65 V operating

–25 V to +75 V survival

Gain = 50 V/V

Wide operating temperature range:

–40°C to +125°C for Y and W grade

–40°C to +150°C for H grade

Bidirectional operation

Available in 8-lead SOIC

Qualified for automotive applications

EXCELLENT AC AND DC PERFORMANCE

15 $\mu\text{V}/^\circ\text{C}$ offset drift

30 ppm/ $^\circ\text{C}$ gain drift

80 dB CMRR dc to 20 kHz

APPLICATIONS

High-side current sensing in:

Motor controls

Transmission controls

Diesel injection controls

Engine management

Suspension controls

Vehicle dynamic controls

DC-to-dc converters

GENERAL DESCRIPTION

The AD8205 is a single-supply difference amplifier for amplifying small differential voltages in the presence of large common-mode voltages. The operating input common-mode voltage range extends from –2 V to +65 V. The typical single-supply voltage is 5 V.

The AD8205 is offered in an 8-lead SOIC package and rated for operation from –40°C to +125°C for the Y and W grade models. The H grade version of the AD8205 is rated from –40°C to +150°C.

Excellent dc performance over temperature keeps errors in the measurement loop to a minimum. Offset drift is typically less

than 15 $\mu\text{V}/^\circ\text{C}$, and gain drift is typically below 30 ppm/ $^\circ\text{C}$.

The output offset can be adjusted from 0.05 V to 4.8 V with a 5 V supply by using the V_{REF1} and V_{REF2} pins. With V_{REF1} attached to the V_+ pin, and V_{REF2} attached to the GND pin, the output is set at half scale. Attaching both pins to GND causes the output to be unipolar, starting near ground. Attaching both pins to V_+ causes the output to be unipolar starting near V_+ . Other offsets can be obtained by applying an external voltage to the V_{REF1} and V_{REF2} pins.

FUNCTIONAL BLOCK DIAGRAM

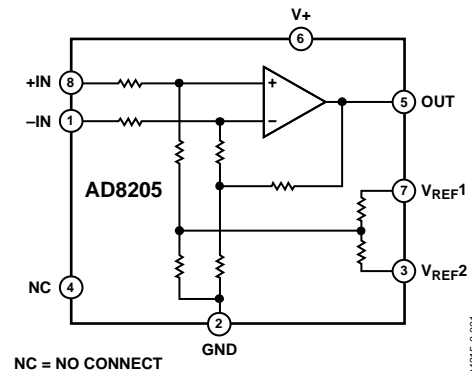

Figure 1.

04315-0-001

Rev. D

Information furnished by Analog Devices is believed to be accurate and reliable. However, no responsibility is assumed by Analog Devices for its use, nor for any infringements of patents or other rights of third parties that may result from its use. Specifications subject to change without notice. No license is granted by implication or otherwise under any patent or patent rights of Analog Devices. Trademarks and registered trademarks are the property of their respective owners.

AD8205* Product Page Quick Links

Last Content Update: 11/01/2016

Comparable Parts

View a parametric search of comparable parts

Documentation

Application Notes

- AN-282: Fundamentals of Sampled Data Systems
- AN-669: Effectively Applying the AD628 Precision Gain Block
- AN-671: Reducing RFI Rectification Errors in In-Amp Circuits

Data Sheet

- AD8205: Single Supply 42 V System Difference Amplifier Data Sheet

Technical Books

- A Designer's Guide to Instrumentation Amplifiers, 3rd Edition, 2006

Tools and Simulations

- AD8205 SPICE Macro Model

Reference Materials

Technical Articles

- Auto-Zero Amplifiers
- Current Measurement in Solenoids for Automotive Control Systems
- High-performance Adder Uses Instrumentation Amplifiers
- Input Filter Prevents Instrumentation-amp RF-Rectification Errors
- The AD8221 - Setting a New Industry Standard for Instrumentation Amplifiers

Design Resources

- AD8205 Material Declaration
- PCN-PDN Information
- Quality And Reliability
- Symbols and Footprints

Discussions

View all AD8205 EngineerZone Discussions

Sample and Buy

Visit the product page to see pricing options

Technical Support

Submit a technical question or find your regional support number

TABLE OF CONTENTS

Features	1	Unidirectional Operation.....	9
Excellent AC and DC Performance.....	1	Ground Referenced Output	9
Applications.....	1	V+ Referenced Output	9
Functional Block Diagram	1	Bidirectional Operation.....	9
General Description	1	External Reference Output.....	10
Revision History	2	Splitting the Supply	10
Specifications.....	3	Splitting an External Reference	10
Absolute Maximum Ratings.....	4	Applications Information	11
ESD Caution.....	4	High-Side Current Sense with a Low-Side Switch.....	11
Pin Configuration and Function Descriptions.....	5	High-Side Current Sense with a High-Side Switch	11
Typical Performance Characteristics	6	Outline Dimensions	12
Theory of Operation	8	Ordering Guide	12
Output Offset Adjustment.....	9	Automotive Products.....	12

REVISION HISTORY

4/12—Rev. C to Rev. D

Added H Grade Temperature Range to Table 2	4
--	---

3/12—Rev. B to Rev. C

Added H Grade Models (Throughout)	1
Added Unit of V/V to Gain in Features Section.....	1
Added Radiometric Accuracy Maximum Parameter of 0.503 V/V, Operating Range Maximum Parameter of 5.5 V, and H Grade Specifications (Table 1)	3
Changes to Theory of Operation Section.....	8
Changes to Ordering Guide	12

7/10—Rev. A to Rev. B

Changes to Features Section and General Description Section .	1
Delete Die Columns, Table 1.....	3
Changes to Table 2.....	4
Changes to Figure 4 and Figure 6.....	6
Changes to Theory of Operation Section.....	8
Changes to Ordering Guide	12
Added Automotive Products Section	12

10/09—Rev. 0 to Rev. A

Changes to Output Resistance Parameter, Table 1	3
Updated Outline Dimensions	12
Changes to Ordering Guide	12

4/04—Revision 0: Initial Version

SPECIFICATIONS

T_A = operating temperature range, $V_S = 5$ V, unless otherwise noted.

Table 1.

Parameter	Test Conditions/Comments	Y and W Grade			H Grade			Unit
		Min	Typ	Max	Min	Typ	Max	
GAIN								
Initial			50			50		V/V
Accuracy	$V_O \geq 0.1$ V dc, 25°C			±1			±1	%
Accuracy Over Temperature	Specified temperature range			±1.2			±1.2	%
Gain vs. Temperature			±30			±30		ppm/°C
VOLTAGE OFFSET								
Offset Voltage (RTI) ¹	25°C			±2		±2		mV
Over Temperature (RTI) ¹	Specified temperature range			±4.5			±4.5	mV
Offset Drift			15			15		µV/°C
INPUT								
Input Impedance								
Differential			400			400		kΩ
Common Mode			200			200		kΩ
Input Voltage Range	Common mode, continuous	−2		65	−2		65	V
	Differential ²		100		100			mV
Common-Mode Rejection	25°C, $f = \text{dc}$ to 20 kHz ³	78	86		78	86		dB
	Operating temperature range, $f = \text{dc}$ to 20 kHz ³	76	80		76	80		dB
OUTPUT								
Output Voltage Range	$R_L = 25$ kΩ	0.05		4.8	0.05		4.8	V
Output Resistance			2			2		Ω
DYNAMIC RESPONSE								
Small Signal −3 dB Bandwidth			50			50		kHz
Slew Rate			0.5			0.5		V/µs
NOISE								
0.1 Hz to 10 Hz, RTI			20			20		µV p-p
Spectral Density, 1 kHz (RTI) ¹			0.5			0.5		µV/√Hz
OFFSET ADJUSTMENT								
Ratiometric Accuracy ⁴	Divider to supplies	0.497		0.503	0.497		0.503	V/V
Accuracy, RTO	Voltage applied to V_{REF1} and V_{REF2} in parallel			±2			±2	mV/V
Output Offset Adjustment Range	$V_S = 5$ V	0.05		4.8	0.05		4.8	V
VREF Divider Resistor Values		24	32	40	24	32	40	kΩ
POWER SUPPLY								
Operating Range		4.5		5.5	4.5		5.5	V
Quiescent Current Over Temperature	$V_O = 0.1$ V dc			2			2.2	mA
Power Supply Rejection Ratio		70			70			dB
Temperature Range								
For Specified Performance	Operating temperature range	−40		+125	−40		+150	°C

¹ RTI is referred to input.

² Input voltage range = ±50 mV with half-scale offset.

³ Source imbalance < 2 Ω.

⁴ The offset adjustment is ratiometric to the power supply when V_{REF1} and V_{REF2} are used as a divider between the supplies.

ABSOLUTE MAXIMUM RATINGS

Table 2.

Parameter	Rating
Supply Voltage	12.5 V
Continuous Input Voltage	-25 V to +75 V
Input Transient Survival	-30 V to +80 V
Differential Input Survival	-25 V to +75 V
Reverse Supply Voltage	0.3 V
Operating Temperature Range	
Y and W Grade	-40°C to +125°C
H Grade	-40°C to +150°C
Storage Temperature	-65 to +150C
Output Short-Circuit Duration	Indefinite

Stresses above those listed under Absolute Maximum Ratings may cause permanent damage to the device. This is a stress rating only and functional operation of the device at these or any other conditions above those indicated in the operational section of this specification is not implied. Exposure to absolute maximum rating conditions for extended periods may affect device reliability.

ESD CAUTION



ESD (electrostatic discharge) sensitive device. Charged devices and circuit boards can discharge without detection. Although this product features patented or proprietary protection circuitry, damage may occur on devices subjected to high energy ESD. Therefore, proper ESD precautions should be taken to avoid performance degradation or loss of functionality.

PIN CONFIGURATION AND FUNCTION DESCRIPTIONS

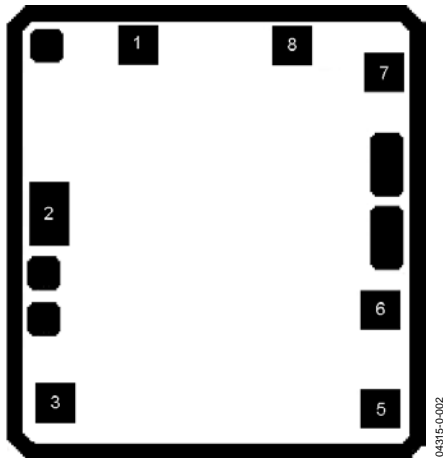

Figure 2. Metallization Diagram

04315-0-002

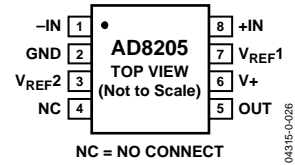

Figure 3. Pin Configuration

04315-0-026

Table 3. Pin Function Descriptions

Pin No.	Mnemonic	X	Y
1	-IN	-206	508
2	GND	-447	57
3	V _{REF2}	-432	-457
4	NC	N/A	N/A
5	OUT	444	-472
6	V+	444	-203
7	V _{REF1}	456	434
8	+IN	203	509

Die size is 1170 μm by 1280 μm .

Die thickness is 13 mil.

Minimum passivation opening (minimum bond pad size) is 92 μm \times 92 μm .

Passivation type is 8KA USG (Oxide) + 10KA Oxynitride.

Bond pad metal composition is 98.5% Al, 1% Si, and 0.5% Cu.

Backside potential is V+.

TYPICAL PERFORMANCE CHARACTERISTICS

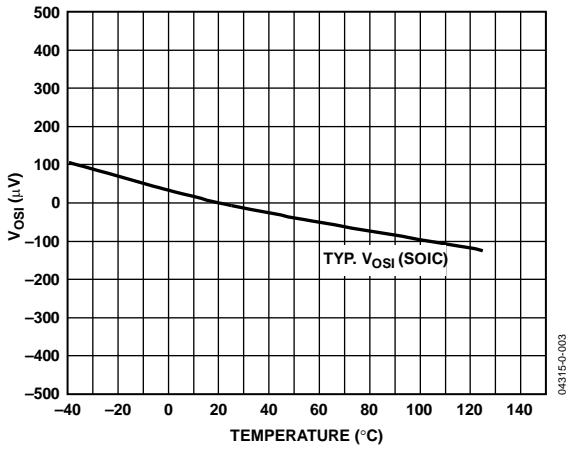

Figure 4. Typical Offset Drift

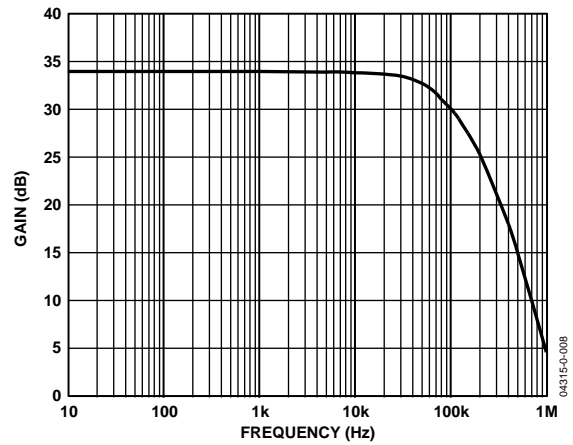

Figure 7. Typical Small Signal Bandwidth ($V_{OUT} = 200\text{ mV p-p}$)

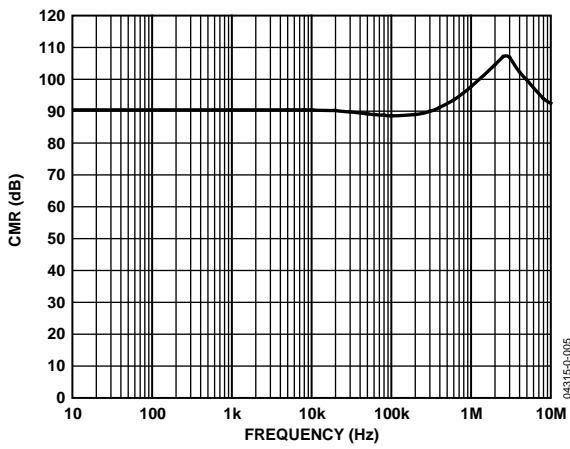

Figure 5. CMR vs. Frequency

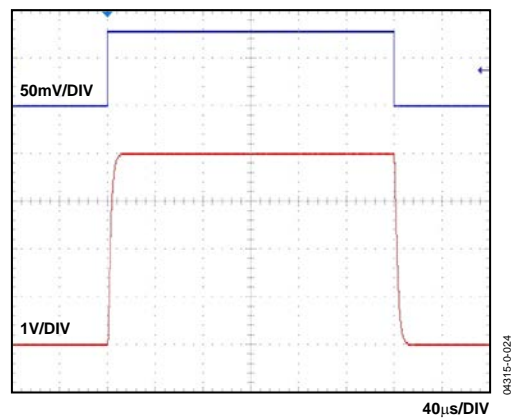

Figure 8. Rise/Fall Time

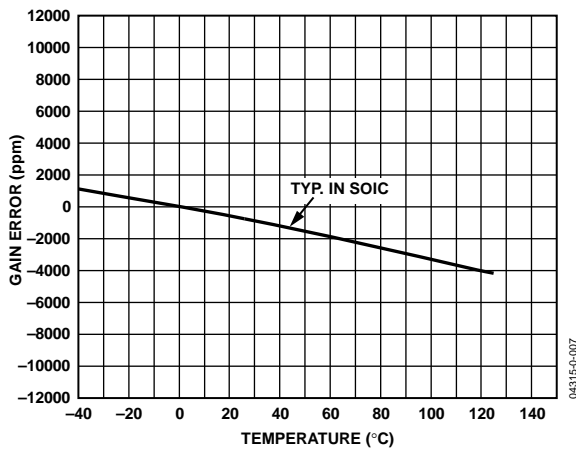

Figure 6. Gain Drift

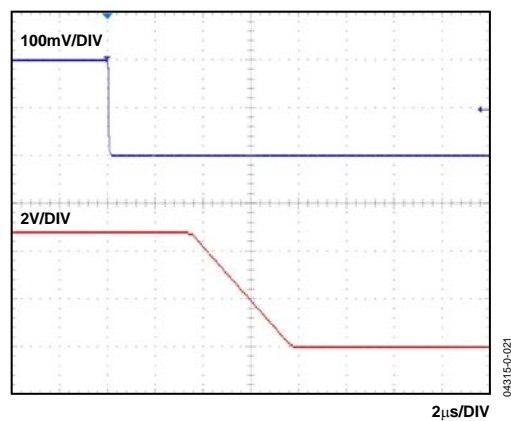

Figure 9. Differential Overload Recovery (Falling)

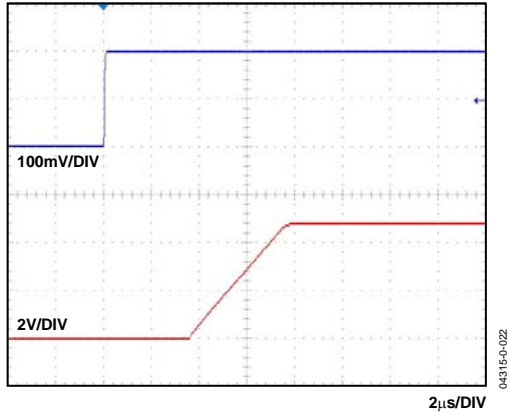

Figure 10. Differential Overload Recovery (Rising)

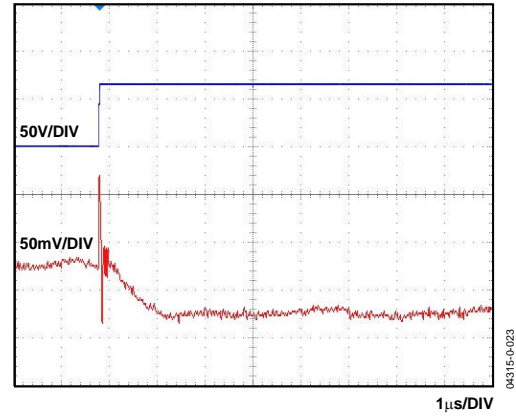

Figure 12. Common-Mode Response

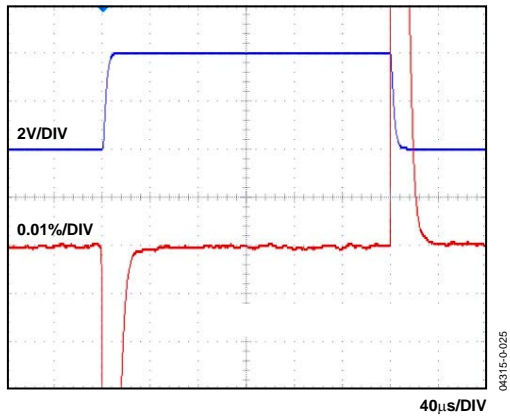

Figure 11. Settling Time

THEORY OF OPERATION

The AD8205 is a single-supply difference amplifier that uses a unique architecture to accurately amplify small differential current shunt voltages in the presence of rapidly changing common-mode voltages.

In typical applications, the AD8205 is used to measure current by amplifying the voltage across a current shunt placed across the inputs.

The gain of the AD8205 is 50 V/V, with an accuracy of 1.2%. This accuracy for the Y and W Grade is guaranteed over the operating temperature range of -40°C to $+125^{\circ}\text{C}$. The H Grade version of the AD8205 is specified for operation from -40°C to $+150^{\circ}\text{C}$.

The input offset is less than 2 mV referred to the input at 25°C , and 4.5 mV maximum referred to the input over the full operating temperature range for the packaged part.

The AD8205 operates with a single supply from 4.5 V to 10 V (absolute maximum = 12.5 V). The supply current is less than 2 mA.

High accuracy trimming of the internal resistors allows the AD8205 to have a common-mode rejection ratio better than 78 dB from dc to 20 kHz.

The output offset can be adjusted from 0.05 V to 4.8 V ($V_{+} = 5\text{ V}$) for unipolar and bipolar operation.

The AD8205 consists of two amplifiers (A1 and A2), a resistor network, small voltage reference, and a bias circuit (not shown), see Figure 13.

The set of input attenuators preceding A1 consist of R_A , R_B , and R_C , which reduce the common-mode voltage to match the input voltage range of A1. The two attenuators form a balanced bridge network. When the bridge is balanced, the differential voltage created by a common-mode voltage is 0 V at the inputs of A1. The input attenuation ratio is 1/16.7. The combined series resistance of R_A , R_B , and R_C is approximately $200\text{ k}\Omega \pm 20\%$.

By attenuating the voltages at Pin 1 and Pin 8, the A1 amplifier inputs are held within the power supply range, even if Pin 1 and Pin 8 exceed the supply or fall below common (ground). A reference voltage of 250 mV biases the attenuator above ground. This allows the amplifier to operate in the presence of negative common-mode voltages.

The input network also attenuates normal (differential) mode voltages. A1 amplifies the attenuated signal by 26. The input and output of this amplifier are differential to maximize the ac common-mode rejection.

A2 converts the differential voltage from A1 into a single-ended signal and provides further amplification. The gain of this second stage is 32.15.

The reference inputs, V_{REF1} and V_{REF2} , are tied through resistors to the positive input of A2, which allows the output offset to be adjusted anywhere in the output operating range. The gain is 1 V/V from the reference pins to the output when the reference pins are used in parallel. The gain is 0.5 V/V when they are used to divide the supply.

The ratios of Resistors R_A , R_B , R_C , R_D , and R_F are trimmed to a high level of precision to allow the common-mode rejection ratio to exceed 80 dB. This is accomplished by laser trimming the resistor ratio matching to better than 0.01%.

The total gain of 50 is made up of the input attenuation of 1/16.7 multiplied by the first stage gain of 26 and the second stage gain of 32.15.

The output stage is Class A with a PNP pull-up transistor and a $300\text{ }\mu\text{A}$ current sink pull-down.

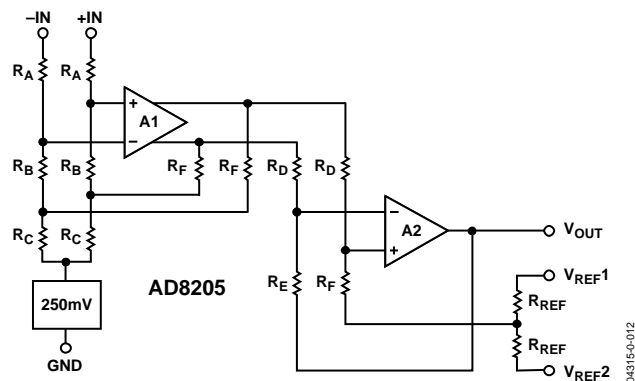

Figure 13. Simplified Schematic

OUTPUT OFFSET ADJUSTMENT

The output of the AD8205 can be adjusted for unidirectional or bidirectional operation.

UNIDIRECTIONAL OPERATION

Unidirectional operation allows the AD8205 to measure currents through a resistive shunt in one direction. The basic modes for unidirectional operation are ground referenced output mode and V+ referenced output mode.

In the case of unidirectional operation, the output could be set at the negative rail (near ground) or at the positive rail (near V+) when the differential input is 0 V. The output moves to the opposite rail when a correct polarity differential input voltage is applied. In this case, full scale is approximately 100 mV. The required polarity of the differential input depends on the output voltage setting. If the output is set at the positive rail, the input polarity needs to be negative to move the output down. If the output is set at ground, the polarity is positive to move the output up.

GROUND REFERENCED OUTPUT

When using the AD8205 in this mode, both reference inputs are tied to ground, which causes the output to sit at the negative rail when there are zero differential volts at the input (see Figure 14).

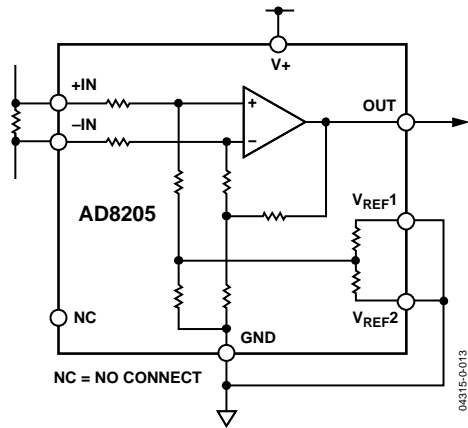

Figure 14. Ground Referenced Output

Table 4. V+ = 5 V

V _{IN} (Referred to -IN)	V _O
0 V	0.05 V
100 mV	4.8 V

V+ REFERENCED OUTPUT

This mode is set when both reference pins are tied to the positive supply. It is typically used when the diagnostic scheme requires detection of the amplifier and the wiring before power is applied to the load (see Figure 15).

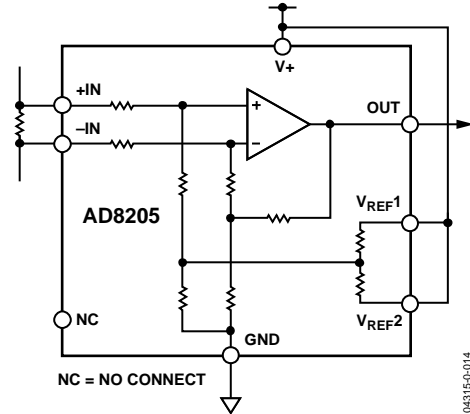

Figure 15. V+ Referenced Output

Table 5. V+ = 5 V

V _{IN} (Referred to -IN)	V _O
0 V	4.8 V
100 mV	0.05 V

BIDIRECTIONAL OPERATION

Bidirectional operation allows the AD8205 to measure currents through a resistive shunt in two directions.

In this case, the output is set anywhere within the output range. Typically, it is set at half-scale for equal range in both directions. In some cases, however, it is set at a voltage other than half-scale when the bidirectional current is nonsymmetrical.

Table 6. V+ = 5 V, V_O = 2.5 with V_{IN} = 0 V

V _{IN} (Referred to -IN)	V _O
+40 mV	4.5 V
-40 mV	0.5 V

Adjusting the output is accomplished by applying voltage(s) to the reference inputs.

V_{REF1} and V_{REF2} are tied to internal resistors that connect to an internal offset node. There is no operational difference between the pins.

EXTERNAL REFERENCE OUTPUT

Tying both pins together and to a reference produces an output at the reference voltage when there is no differential input (see Figure 16). The output moves down from the reference voltage when the input is negative relative to the -IN pin and up when the input is positive relative to the -IN pin.

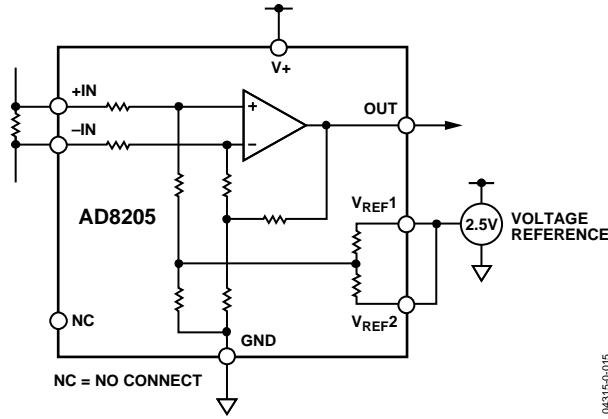

Figure 16. External Reference Output

SPLITTING THE SUPPLY

By tying one reference pin to V+ and the other to the ground pin, the output is set at half of the supply when there is no differential input (see Figure 17). The benefit is that no external reference is required to offset the output for bidirectional current measurement. This creates a midscale offset that is ratiometric to the supply, which means that if the supply increases or decreases, the output remains at half the supply. For example, if the supply is 5.0 V, the output is at half scale or 2.5 V. If the supply increases by 10% (to 5.5 V), the output goes to 2.75 V.

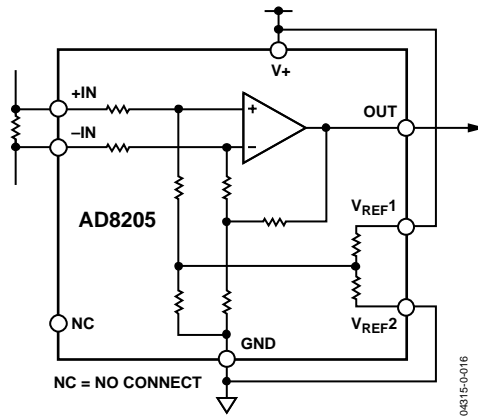

Figure 17. Split Supply

SPLITTING AN EXTERNAL REFERENCE

In this case, an external reference is divided by 2 with an accuracy of approximately 0.5% by connecting one VREF pin to ground and the other VREF pin to the reference (see Figure 18).

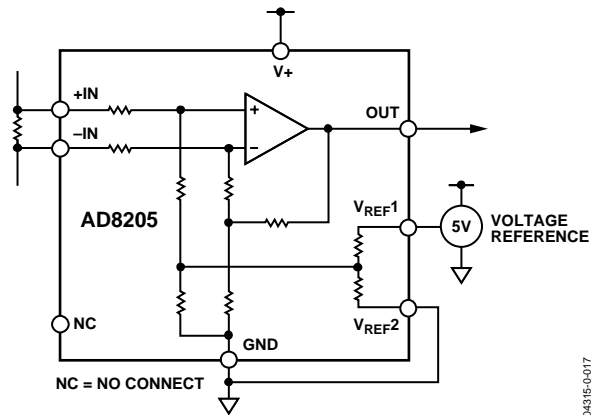

Figure 18. Split External Reference

APPLICATIONS INFORMATION

A typical application for the AD8205 is high-side measurement of a current through a solenoid for PWM control of the solenoid opening. Typical applications include hydraulic transmission control and diesel injection control.

Two typical circuit configurations are used for this type of application.

HIGH-SIDE CURRENT SENSE WITH A LOW-SIDE SWITCH

In this case, the PWM control switch is ground referenced. An inductive load (solenoid) is tied to a power supply. A resistive shunt is placed between the switch and the load (see Figure 19). An advantage of placing the shunt on the high side is that the entire current, including the re-circulation current, can be measured since the shunt remains in the loop when the switch is off. In addition, diagnostics can be enhanced because shorts to ground can be detected with the shunt on the high side.

In this circuit configuration, when the switch is closed, the common-mode voltage moves down to near the negative rail. When the switch is opened, the voltage reversal across the inductive load causes the common-mode voltage to be held one diode drop above the battery by the clamp diode.

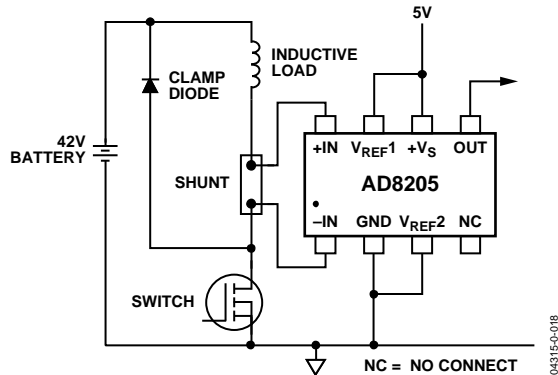

Figure 19. Low-Side Switch

HIGH-SIDE CURRENT SENSE WITH A HIGH-SIDE SWITCH

This configuration minimizes the possibility of unexpected solenoid activation and excessive corrosion (see Figure 20). In this case, both the switch and the shunt are on the high side. When the switch is off, this removes the battery from the load, which prevents damage from potential shorts to ground, while still allowing the recirculating current to be measured and providing for diagnostics. Removing the power supply from the load for the majority of the time minimizes the corrosive effects that could be caused by the differential voltage between the load and ground.

When using a high-side switch, the battery voltage is connected to the load when the switch is closed, causing the common-mode voltage to increase to the battery voltage. In this case, when the switch is opened, the voltage reversal across the inductive load causes the common-mode voltage to be held one diode drop below ground by the clamp diode.

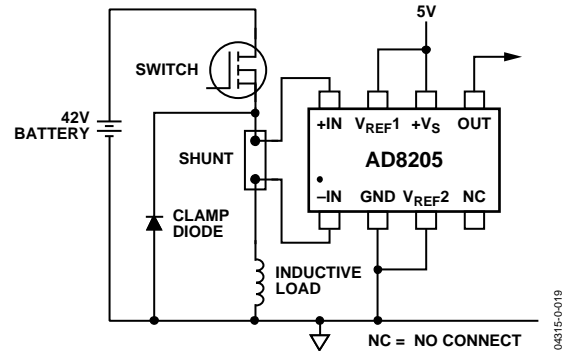

Figure 20. High-Side Switch

Another typical application for the AD8205 is as part of the control loop in H-bridge motor control. In this case, the AD8205 is placed in the middle of the H-bridge (see Figure 21) so that it can accurately measure current in both directions by using the shunt available at the motor. This is a better solution than a ground referenced op amp because ground is not typically a stable reference voltage in this type of application. This instability in the ground reference causes the measurements that could be made with a simple ground referenced op amp to be inaccurate.

The AD8205 measures current in both directions as the H-bridge switches and the motor changes direction. The output of the AD8205 is configured in an external reference bidirectional mode, see the Output Offset Adjustment section.

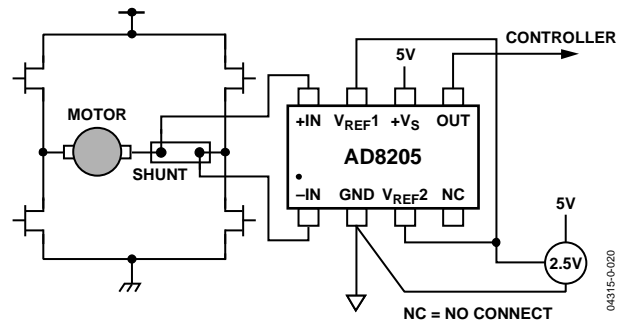
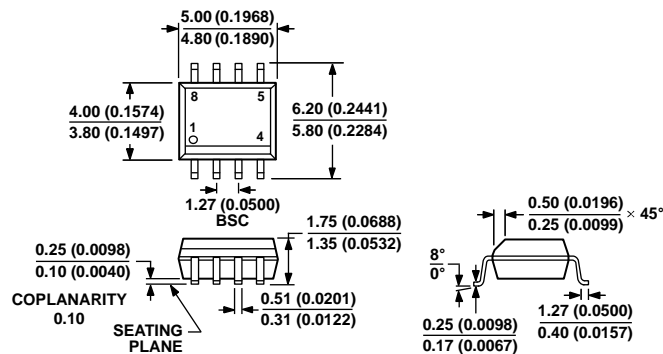

Figure 21. Motor Control Application

OUTLINE DIMENSIONS



COMPLIANT TO JEDEC STANDARDS MS-012-AA
 CONTROLLING DIMENSIONS ARE IN MILLIMETERS; INCH DIMENSIONS
 (IN PARENTHESES) ARE ROUNDED-OFF MILLIMETER EQUIVALENTS FOR
 REFERENCE ONLY AND ARE NOT APPROPRIATE FOR USE IN DESIGN.

Figure 22. 8-Lead Standard Small Outline Package [SOIC_N]
 Narrow Body
 (R-8)

Dimensions shown in millimeters and (inches)

012407-A

ORDERING GUIDE

Model ^{1,2}	Temperature Range	Package Description	Package Option
AD8205YRZ	-40°C to +125°C	8-Lead SOIC_N	R-8
AD8205YRZ-RL	-40°C to +125°C	8-Lead SOIC_N, 13" Tape and Reel	R-8
AD8205YRZ-R7	-40°C to +125°C	8-Lead SOIC_N, 7" Tape and Reel	R-8
AD8205WYRZ	-40°C to +125°C	8-Lead SOIC_N	R-8
AD8205WYRZ-RL	-40°C to +125°C	8-Lead SOIC_N, 13" Tape and Reel	R-8
AD8205WYRZ-R7	-40°C to +125°C	8-Lead SOIC_N, 7" Tape and Reel	R-8
AD8205WHRZ	-40°C to +150°C	8-Lead SOIC_N	R-8
AD8205WHRZ-RL	-40°C to +150°C	8-Lead SOIC_N, 13" Tape and Reel	R-8

¹ Z = RoHS Compliant Part.

² W = Qualified for Automotive Applications.

AUTOMOTIVE PRODUCTS

The AD8205WYRZ and AD8205WHRZ models are available with controlled manufacturing to support the quality and reliability requirements of automotive applications. Note that these automotive models may have specifications that differ from the commercial models; therefore, designers should review the Specifications section of this data sheet carefully. Only the automotive grade products shown are available for use in automotive applications. Contact your local Analog Devices account representative for specific product ordering information and to obtain the specific Automotive Reliability reports for these models.