

FEATURES

- Supports DOCSIS Standard for Reverse Path Transmission
- Gain Programmable in 0.75 dB Steps over a 53.5 dB Range
- Low Distortion at 65 dBmV Output
 - 62 dBc SFDR at 21 MHz
 - 58 dBc SFDR at 65 MHz
- 1 dB Compression of 25 dBm at 10 MHz
- Output Noise Level
 - 45 dBmV in 160 kHz
- Maintains 75 Ω Output Impedance
- Power-Up and Power-Down Condition
- Upper Bandwidth: 100 MHz (Full Gain Range)
- Single or Dual Supply Operation

APPLICATIONS

- Gain-Programmable Line Driver
- CATV Telephony Modems
- CATV Terminal Devices
- General-Purpose Digitally Controlled Variable Gain Block

GENERAL DESCRIPTION

The AD8326 is a high-output power, digitally controlled, variable gain amplifier optimized for coaxial line driving applications such as data and telephony cable modems that are designed to the MCNS-DOCSIS upstream standard. An 8-bit serial word determines the desired output gain over a 53.5 dB range resulting in gain changes of 0.75 dB/LSB. The AD8326 is offered in two models, each optimized to support the desired output power and resulting performance.

The AD8326 comprises a digitally controlled variable attenuator of 0 dB to -54 dB, that is preceded by a low noise, fixed-gain buffer and is followed by a low distortion high-power amplifier. The AD8326 accepts a differential or single-ended input signal. The output is designed to drive a 75 Ω load, such as coaxial cable, although the AD8326 is capable of driving other loads.

When driving 67 dBm into a 75 Ω load, the AD8326ARP provides a worst harmonic of only -59 dBc at 21 MHz and -57 dBc at 42 MHz. When driving 65 dBmV into a 75 Ω load, the AD8326ARE provides a worst harmonic of only -62 dBc at 21 MHz and -60 dBc at 42 MHz.

FUNCTIONAL BLOCK DIAGRAM

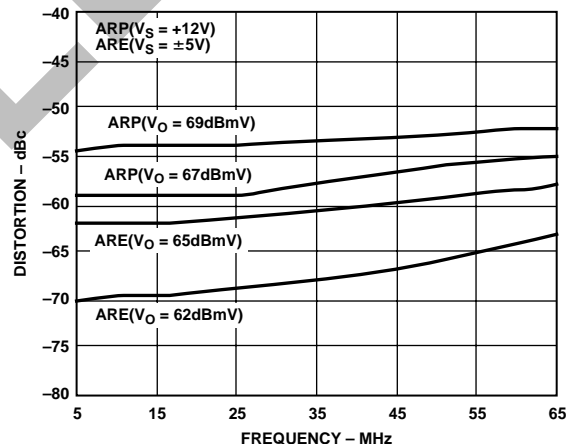
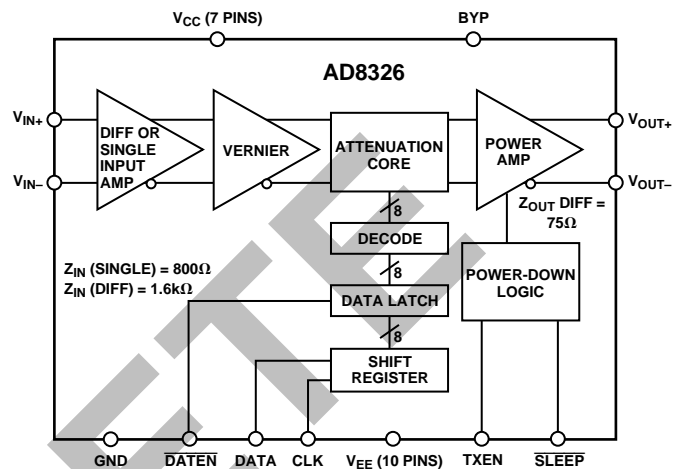

Figure 1. Worst Harmonic Distortion vs. Frequency

The differential output of the AD8326 is compliant with DOCSIS paragraph 4.2.10.2 for "Spurious Emissions During Burst On/Off Transients." In addition, this device has a sleep mode function that reduces the quiescent current to 4 mA.

The AD8326 is packaged in a low-cost 28-lead TSSOP and a 28-lead P (power) SOIC. Both devices have an operational temperature range of -40°C to +85°C.

REV. 0

Information furnished by Analog Devices is believed to be accurate and reliable. However, no responsibility is assumed by Analog Devices for its use, nor for any infringements of patents or other rights of third parties that may result from its use. No license is granted by implication or otherwise under any patent or patent rights of Analog Devices.

AD8326—SPECIFICATIONS ($T_A = 25^\circ\text{C}$, $V_S = 12\text{ V}$, $R_L = R_{IN} = 75\ \Omega$, $V_{IN} = 259\text{ mV p-p}$, V_{OUT} measured through a 1:1 transformer with an insertion loss of 0.5 dB @ 10 MHz, unless otherwise noted.)

Parameter	Conditions	AD8326ARP			Unit
		Min	Typ	Max	
INPUT CHARACTERISTICS					
Specified AC Voltage	Output = 67 dBmV, Max Gain		259		mV p-p
Noise Figure	Max Gain, $f = 10\text{ MHz}$		16.6		dB
Input Resistance	Differential Input		1600		Ω
	Single-Ended Input		800		Ω
Input Capacitance			2		pF
GAIN CONTROL INTERFACE					
Gain Range		52.5	53.5	54.5	dB
Maximum Gain	Gain Code = 71 Dec	26.5	27.5	28.5	dB
Minimum Gain	Gain Code = 0 Dec	-27	-26	-25	dB
Gain Scaling Factor			0.7526		dB/LSB
Gain Linearity Error	$f = 10\text{ MHz}$, Code-to-Code		± 0.2		dB
OUTPUT CHARACTERISTICS					
Bandwidth (-3 dB)	All Gain Codes		100		MHz
Bandwidth Roll-Off	$f = 65\text{ MHz}$		1.2		dB
Bandwidth Peaking	$f = 65\text{ MHz}$		0		dB
Output Noise Spectral Density	Max Gain, $f = 10\text{ MHz}$		-28		dBmV in 160 kHz
	Min Gain, $f = 10\text{ MHz}$		-45.5		dBmV in 160 kHz
	Transmit Disable Mode, $f = 10\text{ MHz}$		-65		dBmV in 160 kHz
1 dB Compression Point	Max Gain, $f = 10\text{ MHz}$		26.5		dBm
Differential Output Impedance	Transmit Enable and Transmit Disable Mode		$75 \pm 20\%$		Ω
OVERALL PERFORMANCE					
Worst Harmonic Distortion	$f = 14\text{ MHz}$, $V_{OUT} = 67\text{ dBmV @ Max Gain}$		-59		dBc
	$f = 21\text{ MHz}$, $V_{OUT} = 67\text{ dBmV @ Max Gain}$		-59		dBc
	$f = 42\text{ MHz}$, $V_{OUT} = 67\text{ dBmV @ Max Gain}$		-57		dBc
	$f = 65\text{ MHz}$, $V_{OUT} = 67\text{ dBmV @ Max Gain}$		-55		dBc
Adjacent Channel Power	16 QAM, $V_{OUT} = 67\text{ dBmV}$ Adj Ch Wid = Tr Ch Wid = 160 KSYM/SEC		-56		dBc
Output Settling					
Due to Gain Change (T_{GS})	Min to Max Gain		60		ns
Due to Input Step Change	Max Gain, $V_{IN} = 0\text{ V to }0.25\text{ V p-p}$		30		ns
Signal Isolation	Min Gain, TXEN = 0, 65 MHz, $V_{IN} = 0.25\text{ V p-p}$		-85		dBc
	Max Gain, TXEN = 0, 42 MHz, $V_{IN} = 0.25\text{ V p-p}$		-31		dBc
	Max Gain, TXEN = 0, 65 MHz, $V_{IN} = 0.25\text{ V p-p}$		-28		dBc
	All Gains, SLEEP, 65 MHz, $V_{IN} = 0.25\text{ V p-p}$		-85		dBc
POWER CONTROL					
Transmit Enable Response Time (t_{ON})	Max Gain, $V_{IN} = 0$		250		ns
Transmit Disable Response Time (t_{OFF})	Max Gain, $V_{IN} = 0$		40		ns
Between Burst Transients ¹	Equivalent Output = 31 dBmV		5		mV p-p
	Equivalent Output = 61 dBmV		60		mV p-p
POWER SUPPLY					
Operating Range		11.4	12	12.6	V
Quiescent Current	Transmit Enable Mode (TXEN = 1)	147	157	167	mA
	Transmit Disable Mode (TXEN = 0)	38	44	50	mA
	Sleep Mode	1.5	4.5	7.5	mA
OPERATING TEMPERATURE RANGE					
		-40		+85	$^\circ\text{C}$

NOTES

¹Between Burst Transients measured at the output of diplexer.

Specifications subject to change without notice.

SPECIFICATIONS

($T_A = 25^\circ\text{C}$, $V_S = \pm 5\text{ V}$, $R_L = R_{IN} = 75\ \Omega$, $V_{IN} = 206\text{ V p-p}$, V_{OUT} measured through a 1:1 transformer with an insertion loss of 0.5 dB @ 10 MHz, unless otherwise noted.)

Parameter	Conditions	AD8326ARE			Unit
		Min	Typ	Max	
INPUT CHARACTERISTICS					
Specified AC Voltage	Output = 65 dBmV, Max Gain		206		mV p-p
Noise Figure	Max Gain, $f = 10\text{ MHz}$		16.6		dB
Input Resistance	Differential Input		1600		Ω
	Single-Ended Input		800		Ω
Input Capacitance			2		pF
GAIN CONTROL INTERFACE					
Gain Range		52.5	53.5	54.5	dB
Maximum Gain	Gain Code = 71 Dec	26.5	27.5	28.5	dB
Minimum Gain	Gain Code = 0 Dec	-27	-26	-25	dB
Gain Scaling Factor			0.7526		dB/LSB
Gain Linearity Error	$f = 10\text{ MHz}$, Code-to-Code		± 0.2		dB
OUTPUT CHARACTERISTICS					
Bandwidth (-3 dB)	All Gain Codes		100		MHz
Bandwidth Roll-Off	$f = 65\text{ MHz}$		1.1		dB
Bandwidth Peaking	$f = 65\text{ MHz}$		0		dB
Output Noise Spectral Density	Max Gain, $f = 10\text{ MHz}$		-28		dBmV in 160 kHz
	Min Gain, $f = 10\text{ MHz}$		-45.5		dBmV in 160 kHz
	Transmit Disable Mode, $f = 10\text{ MHz}$		-65		dBmV in 160 kHz
1 dB Compression Point	Max Gain, $f = 10\text{ MHz}$		25.0		dBm
Differential Output Impedance	Transmit Enable and Transmit Disable Mode		$75 \pm 20\%$		Ω
OVERALL PERFORMANCE					
Worst Harmonic Distortion	$f = 14\text{ MHz}$, $V_{OUT} = 65\text{ dBmV @ Max Gain}$		-62		dBc
	$f = 21\text{ MHz}$, $V_{OUT} = 65\text{ dBmV @ Max Gain}$		-62		dBc
	$f = 42\text{ MHz}$, $V_{OUT} = 65\text{ dBmV @ Max Gain}$		-60		dBc
	$f = 65\text{ MHz}$, $V_{OUT} = 65\text{ dBmV @ Max Gain}$		-58		dBc
Adjacent Channel Power	16 QAM, $V_{OUT} = 65\text{ dBmV}$ Adj Ch Wid = Tr Ch Wid = 160 KSYM/SEC		-58		dBc
Output Settling					
Due to Gain Change (T_{GS})	Min to Max Gain		60		ns
Due to Input Step Change	Max Gain, $V_{IN} = 0\text{ V to }0.19\text{ V p-p}$		30		ns
Signal Isolation	Min Gain, TXEN = 0, 65 MHz, $V_{IN} = 0.19\text{ V p-p}$		-85		dBc
	Max Gain, TXEN = 0, 42 MHz, $V_{IN} = 0.19\text{ V p-p}$		-31		dBc
	Max Gain, TXEN = 0, 65 MHz, $V_{IN} = 0.19\text{ V p-p}$		-28		dBc
	All Gains, SLEEP, 65 MHz, $V_{IN} = 0.19\text{ V p-p}$		-85		dBc
POWER CONTROL					
Transmit Enable Response Time (t_{ON})	Max Gain, $V_{IN} = 0$		250		ns
Transmit Disable Response Time (t_{OFF})	Max Gain, $V_{IN} = 0$		40		ns
Between Burst Transients ¹	Equivalent Output = 31 dBmV		5		mV p-p
	Equivalent Output = 61 dBmV		60		mV p-p
POWER SUPPLY					
Operating Range		± 4.75	± 5.0	± 5.25	V
Quiescent Current	Transmit Enable Mode (TXEN = 1)	140	150	160	mA
	Transmit Disable Mode (TXEN = 0)	36	42	48	mA
	Sleep Mode	1	4	7	mA
OPERATING TEMPERATURE RANGE					
		-40		+85	$^\circ\text{C}$

NOTES

¹Between Burst Transients measured at the output of diplexer.

Specifications subject to change without notice.

AD8326

LOGIC INPUTS (TTL/CMOS Compatible Logic) ($\overline{\text{DATEN}}$, CLK, SDATA, TXEN, $\overline{\text{SLEEP}}$, $V_{CC} = 12\text{ V}$: Full Temperature Range)

Parameter	Min	Typ	Max	Unit
Logic "1" Voltage	2.1		5.0	V
Logic "0" Voltage	0		0.8	V
Logic "1" Current ($V_{\text{INL}} = 5\text{ V}$) CLK, SDATA, $\overline{\text{DATEN}}$	0		20	nA
Logic "0" Current ($V_{\text{INL}} = 0\text{ V}$) CLK, SDATA, $\overline{\text{DATEN}}$	-600		-100	nA
Logic "1" Current ($V_{\text{INL}} = 5\text{ V}$) TXEN	50		190	μA
Logic "0" Current ($V_{\text{INL}} = 0\text{ V}$) TXEN	-250		-30	μA
Logic "1" Current ($V_{\text{INL}} = 5\text{ V}$) $\overline{\text{SLEEP}}$	50		190	μA
Logic "0" Current ($V_{\text{INL}} = 0\text{ V}$) $\overline{\text{SLEEP}}$	-250		-30	μA

Specifications subject to change without notice.

TIMING REQUIREMENTS (Full Temperature Range, $V_{CC} = 12\text{ V}$, $t_R = t_F = 4\text{ ns}$, $f_{\text{CLK}} = 8\text{ MHz}$ unless otherwise noted.)

Parameter	Min	Typ	Max	Unit
Clock Pulsewidth (t_{WH})	16.0			ns
Clock Period (t_C)	32.0			ns
Setup Time SDATA vs. Clock (t_{DS})	5.0			ns
Setup Time $\overline{\text{DATEN}}$ vs. Clock (t_{ES})	15.0			ns
Hold Time SDATA vs. Clock (t_{DH})	5.0			ns
Hold Time $\overline{\text{DATEN}}$ vs. Clock (t_{EH})	3.0			ns
Input Rise and Fall Times, SDATA, $\overline{\text{DATEN}}$, Clock (t_R, t_F)			10	ns

Specifications subject to change without notice.

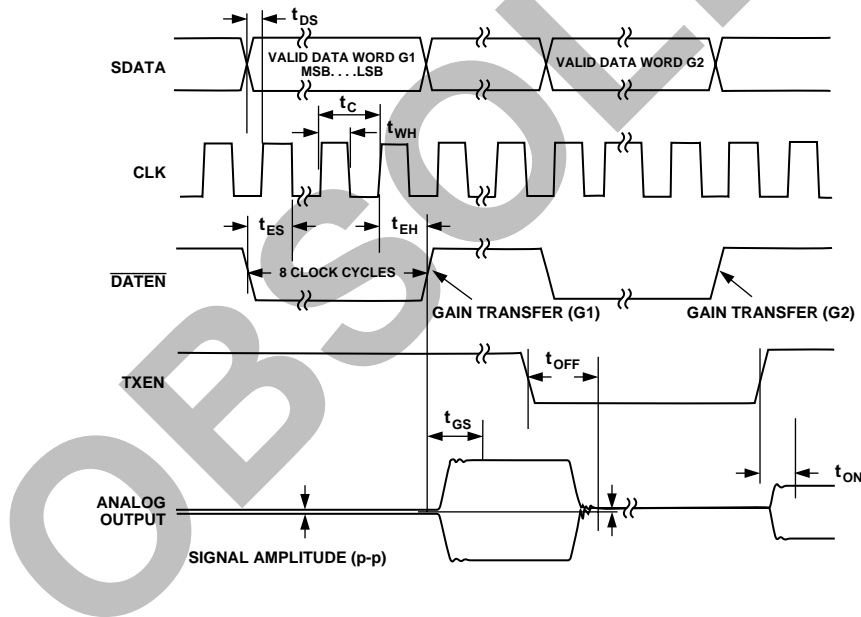

Figure 2. Serial Interface Timing

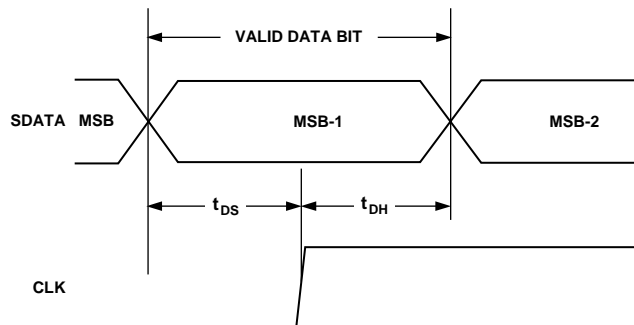

Figure 3. SDATA Timing

ABSOLUTE MAXIMUM RATINGS*Supply Voltage V_{CC} Pins 5, 9, 10, 19, 20, 23, 27 . For ARP, Max $V_{CC} = V_{EE} + 13$ V;..... For ARE, Max $V_{CC} = V_{EE} + 11$ V

Input Voltages

Pins 25, 26 ± 0.5 VPins 1, 2, 3, 6, 7 -0.8 V to $+5.5$ V

Internal Power Dissipation

TSSOP EPAD 1.5 W

PSOP 2.0 W

Operating Temperature Range -40°C to $+85^{\circ}\text{C}$ Storage Temperature Range -65°C to $+150^{\circ}\text{C}$ Lead Temperature, Soldering 60 seconds 300°C

*Stresses above those listed under Absolute Maximum Ratings may cause permanent damage to the device. This is a stress rating only; functional operation of the device at these or any other conditions above those indicated in the operational section of this specification is not implied. Exposure to absolute maximum rating conditions for extended periods may affect device reliability.

ORDERING GUIDE

Model	Temperature Range	Package Description	θ_{JA}	Package Option
AD8326ARP AD8326ARP-REEL AD8326ARP-EVAL	-40°C to $+85^{\circ}\text{C}$	28-Lead Power SOIC with Slug Evaluation Board	$23^{\circ}\text{C}/\text{W}^*$	RP-28
AD8326ARE AD8326ARE-REEL AD8326ARE-EVAL	-40°C to $+85^{\circ}\text{C}$	28-Lead TSSOP with Exposed Pad Evaluation Board	$39^{\circ}\text{C}/\text{W}^*$	RE-28

*Thermal Resistance measured on SEMI standard 4-layer board.

CAUTION

ESD (electrostatic discharge) sensitive device. Electrostatic charges as high as 4000 V readily accumulate on the human body and test equipment and can discharge without detection. Although the AD8326 features proprietary ESD protection circuitry, permanent damage may occur on devices subjected to high-energy electrostatic discharges. Therefore, proper ESD precautions are recommended to avoid performance degradation or loss of functionality.



PIN CONFIGURATION

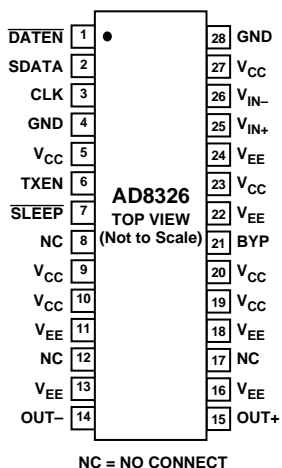

PIN FUNCTION DESCRIPTIONS

Pin No.	Mnemonic	Description
1	$\overline{\text{DATEN}}$	Data Enable Low Input. This port controls the 8-bit parallel data latch and shift register. A Logic 0-to-1 transition transfers the latched data to the attenuator core (updates the gain) and simultaneously inhibits serial data transfer into the register. A 1-to-0 transition inhibits the data latch (holds the previous gain state) and simultaneously enables the register for serial data load.
2	SDATA	Serial Data Input. This digital input allows for an 8-bit serial (gain) word to be loaded into the internal register with the MSB (Most Significant Bit) first and ignored.
3	CLK	Clock Input. The clock port controls the serial attenuator data transfer rate to the 8-bit master-slave register. A Logic 0-to-1 transition latches the data bit and a 1-to-0 transfers the data bit to the slave. This requires the input serial data word to be valid at or before this clock transition.
4, 28	GND	Common External Ground Reference
5, 9, 10, 19, 20, 23, 27	V_{CC}	Common Positive External Supply Voltage. A 0.1 μF capacitor must decouple each pin.
6	TXEN	Transmit Enable pin. Logic 1 powers up the part.
7	$\overline{\text{SLEEP}}$	Low Power Sleep Mode. In the Sleep mode, the AD8326's supply current is reduced to 4 mA. A Logic 0 powers down the part (High Z_{OUT} State) and a Logic 1 powers up the part.
8, 12, 17	NC	No Connection to these pins.
11, 13, 16, 18, 22, 24	V_{EE}	Common Negative External Supply Voltage. A 0.1 μF capacitor must decouple each pin.
14	OUT-	Negative Output Signal
15	OUT+	Positive Output Signal
21	BYP	Internal Bypass. This pin must be externally ac-coupled (0.1 μF capacitor).
25	V_{IN+}	Noninverting Input. DC-biased to approximately $V_{CC}/2$. Should be ac-coupled with a 0.1 μF capacitor.
26	V_{IN-}	Inverting Input. DC-biased to approximately $V_{CC}/2$. Should be ac-coupled with a 0.1 μF capacitor.

Typical Performance Characteristics—AD8326

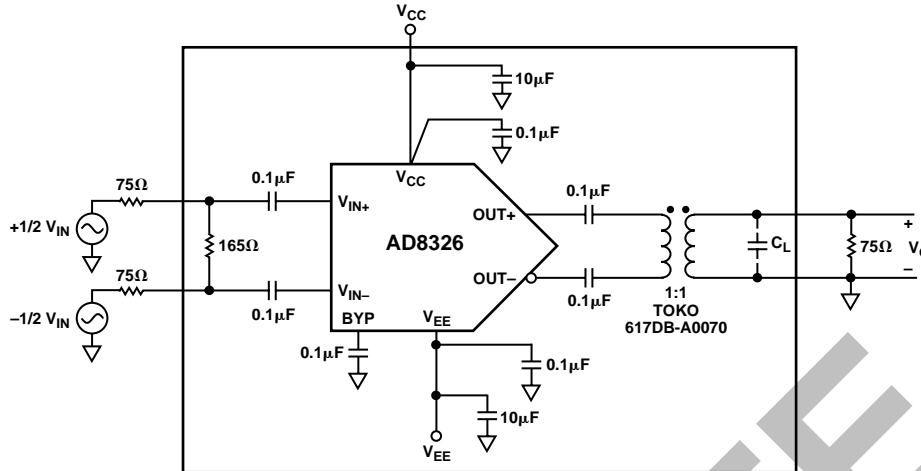

TPC 1. Test Circuit

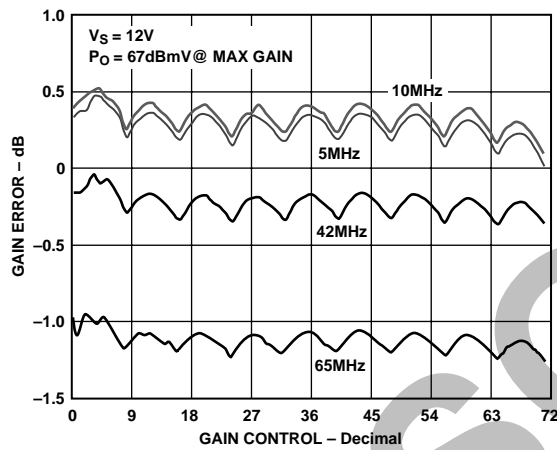

TPC 2. Gain Error vs. Gain Control

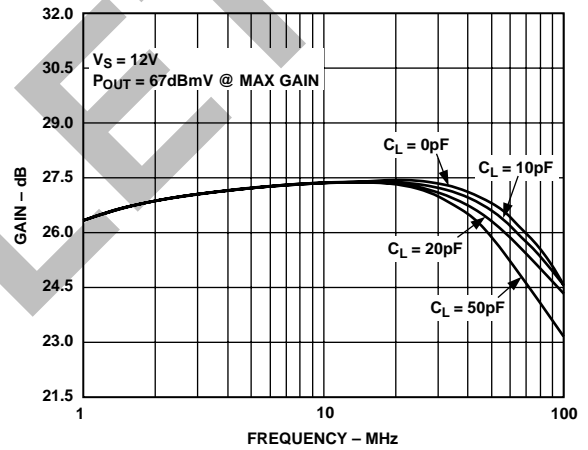

TPC 4. AC Response for Various Capacitor Loads

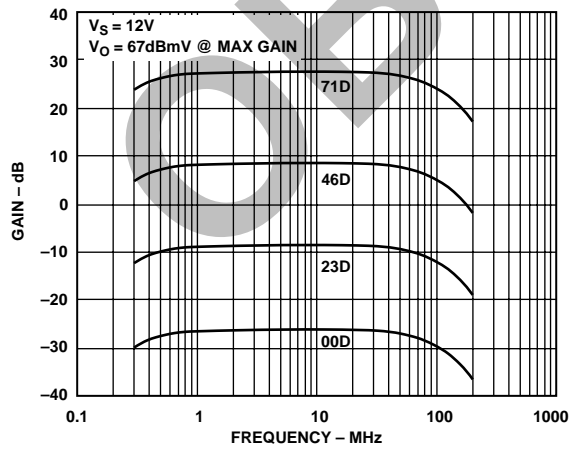

TPC 3. AC Response

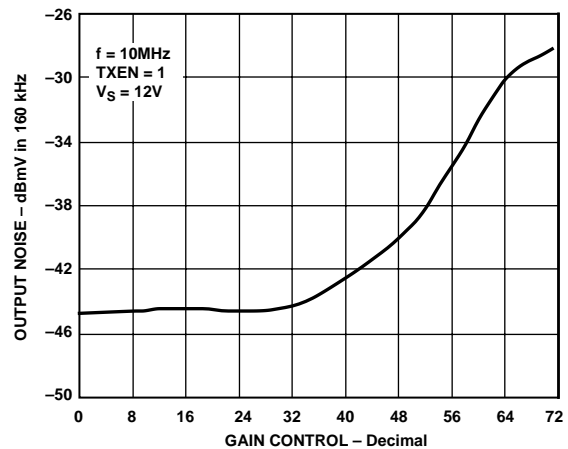

TPC 5. Output Referred Noise vs. Gain Control

AD8326

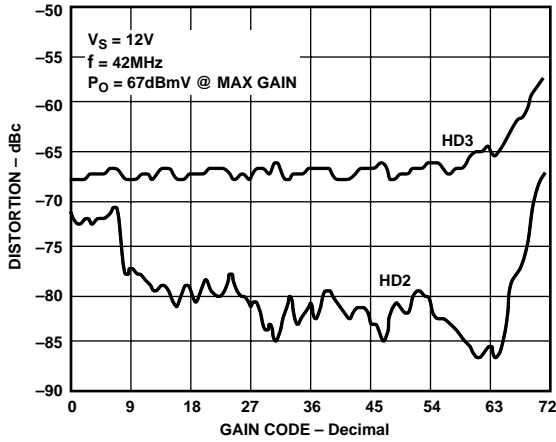

TPC 6. Harmonic Distortion vs. Gain Code for AD8326-ARP

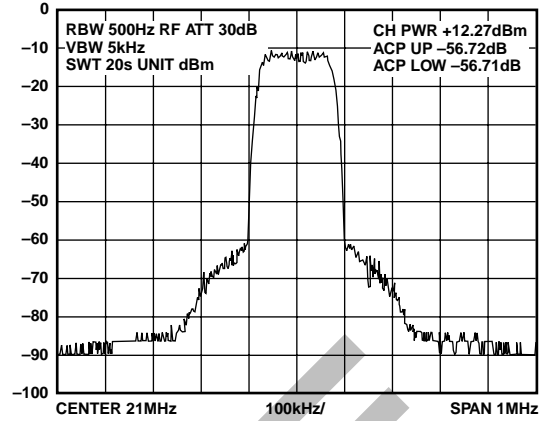

TPC 9. Adjacent Channel Power for AD8326-ARP

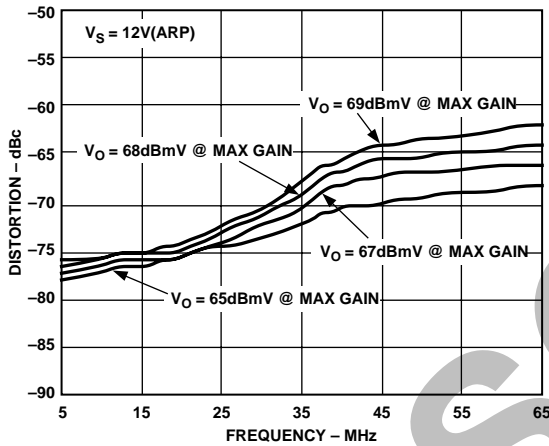

TPC 7. Second Order Harmonic Distortion vs. Frequency for Various Output Powers

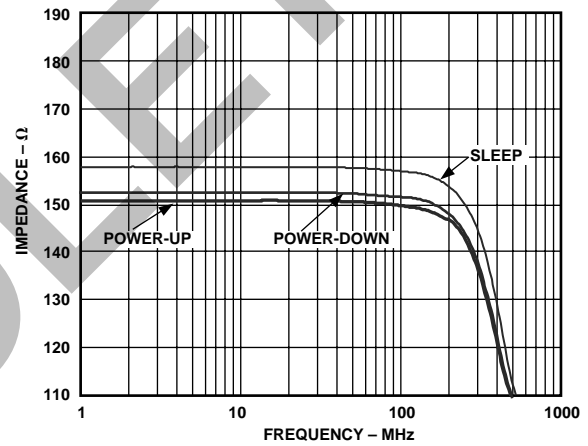

TPC 10. Input Impedance vs. Frequency (Inputs Shunted with 165 Ω)

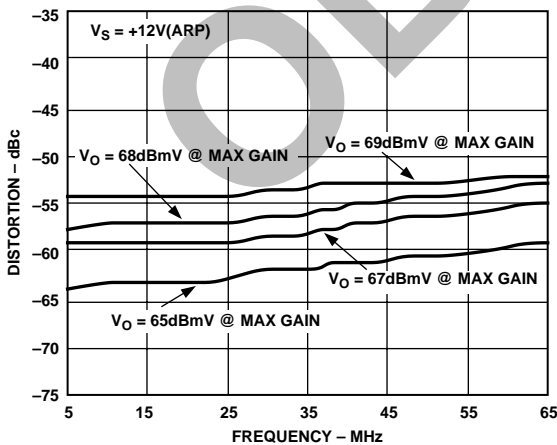

TPC 8. Third Order Harmonic Distortion vs. Frequency for Various Output Powers

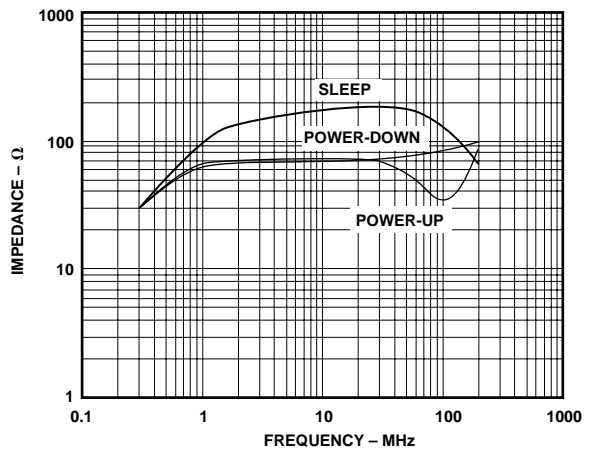

TPC 11. Output Impedance vs. Frequency

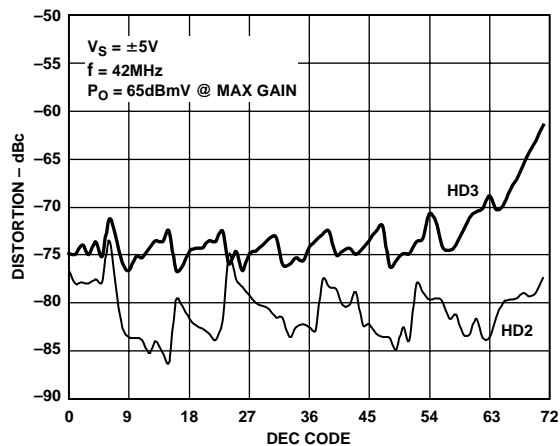

TPC 12. Harmonic Distortion vs. Gain Control for AD8326-ARE

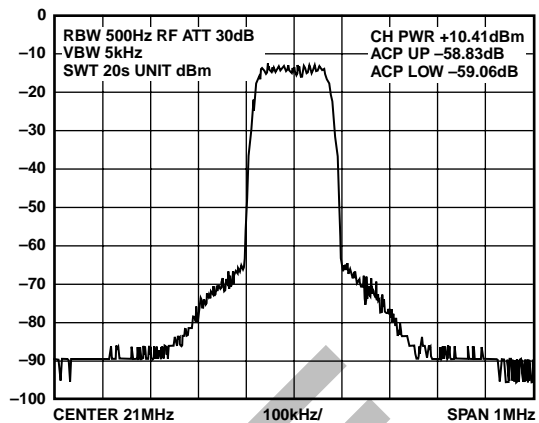

TPC 15. Adjacent Channel Power for AD8326-ARE

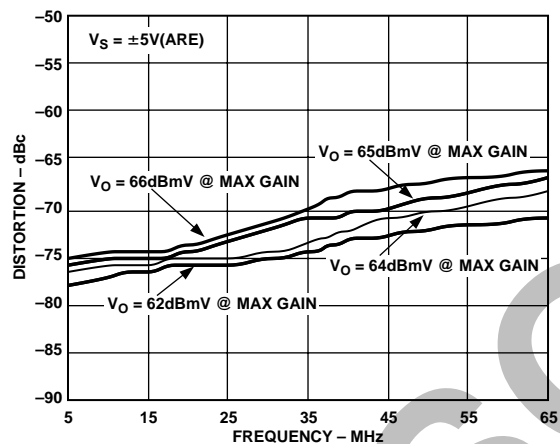

TPC 13. Second Order Harmonic Distortion vs. Frequency for Various Output Powers

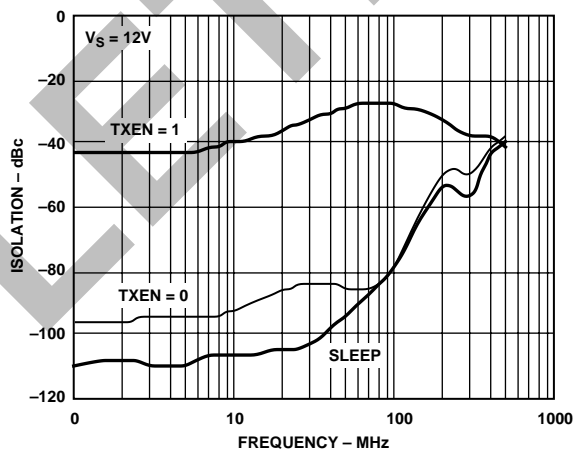

TPC 16. Signal Isolation vs. Frequency

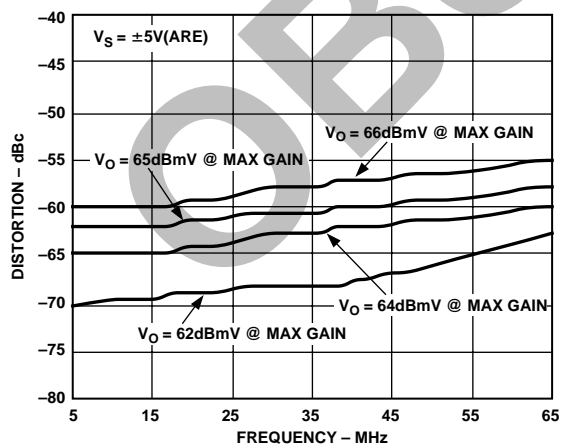

TPC 14. Third Order Harmonic Distortion vs. Frequency for Various Output Powers

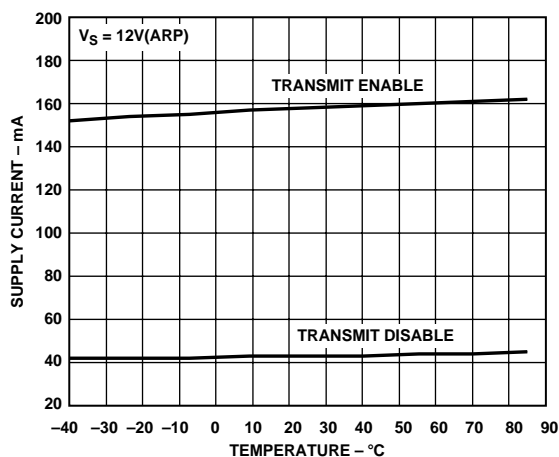

TPC 17. Quiescent Current vs. Temperature

AD8326

APPLICATIONS

General Applications

The AD8326 is primarily intended for use as the upstream power amplifier (PA), also known as a line driver, in DOCSIS (Data Over Cable Service Interface Specification) certified cable modems, cable telephony systems, and CATV set-top boxes. The upstream signal is either a QPSK or QAM signal generated by a DSP, a dedicated QPSK/QAM modulator, or a DAC. In all cases the signal must be low-pass filtered before being applied to the PA in order to filter out-of-band noise and higher order harmonics from the amplified signal. Due to the varying distances between the cable modem and the headend, the upstream PA must be capable of varying the output power by applying gain or attenuation. The varying output power of the AD8326 ensures that the signal from the cable modem will have the proper level once it arrives at the headend. The upstream signal path also contains a transformer, a diplexer, and cable splitters. The AD8326 has been designed to overcome losses associated with these passive components in the upstream cable path, particularly in modems that support cable telephony.

AD8326ARP Applications

The AD8326ARP is in a thermally enhanced PSOP2 package, and designed for single 12 V supply and output power applications up to +69 dBmV. The AD8326ARP will provide maximum performance in 12 V systems.

AD8326ARE Applications

The AD8326ARE is in a TSSOP package with an exposed thermal pad. It is designed for dual ± 5 V or single 10 V supplies. For applications requiring up to 65 dBmV of output power, lower cost, smaller package, and lower power dissipation, the TSSOP package is most appropriate.

Operational Description

The AD8326 consists of four analog functions in the transmit enable or forward mode. The input amplifier (preamp) can be used single-ended or differentially. If the input is used in the differential configuration, it is imperative that the input signals be 180 degrees out of phase and of equal amplitudes. This will ensure proper gain accuracy and harmonic performance. The preamp stage drives a vernier stage that provides the fine tune gain adjustment. The approximate step resolution of 0.75 dB is implemented in this stage and provides a total of approximately 5.25 dB of accumulated attenuation. After the vernier stage, a DAC provides the bulk of the AD8326's attenuation (8 bits or 48 dB). The signals in the preamp and vernier gain blocks are differential to improve the PSRR and linearity. A differential current is fed from the DAC into the output stage, which amplifies these currents to the appropriate levels necessary to drive a 75 Ω load.

The output stage utilizes negative feedback to implement a differential 75 Ω output impedance, which eliminates the need for external matching resistors needed in typical video (or video filter) termination requirements.

SPI Programming

The AD8326 is controlled through a serial peripheral interface (SPI) of three digital data lines, CLK, $\overline{\text{DATEN}}$, and SDATA. Changing the gain requires 8 bits of data to be streamed into the SDATA port. The sequence of loading the SDATA register begins on the falling edge of the $\overline{\text{DATEN}}$ pin, which activates the CLK line. With the CLK line activated, data on the SDATA line is clocked into the serial shift register, Most Significant Bit (MSB) first, on the rising edge of the CLK pulses. Since a 7-bit shift register is used in the AD8326, the MSB of the 8-bit word is a "don't care" bit and is shifted out of the register on the eighth clock pulse. The data is latched into the attenuator core on the rising edge of the $\overline{\text{DATEN}}$ line. This provides control over the changes in the output signal level. The serial interface timing for the AD8326 is shown in Figures 2 and 3. The programmable gain range of the AD8326 is -25.75 dB to $+27.5$ dB with steps of 0.75 dB. This provides a total gain range of 53.25 dB. The AD8326 was characterized with a TOKO transformer (TOKO #617DB-A0070), and the stated gain values include the losses due to the transformer.

For gain codes from 0 through 71 the gain transfer function is:

$$[A_V = 27.5 \text{ dB} - (0.75 \text{ dB} \times (71 - \text{CODE})]$$

where A_V is the gain in dB and CODE is the decimal equivalent of the 8-bit word. Gain codes 0 to 71 provide linear changes in gain. Figure 4 shows the gain characteristics of the AD8326 for all possible values in an 8-bit word. Note that maximum gain is achieved at Code 71. From Code 72 through 127 the 5.25 dB of attenuation from the vernier stage is being applied over every eight codes, resulting in the saw tooth characteristic at the top of the gain range. Because the eighth bit is shifted out of the register, the gain characteristics for Codes 128 through 255 are identical to Codes 0 through 127, as depicted in Figure 4.

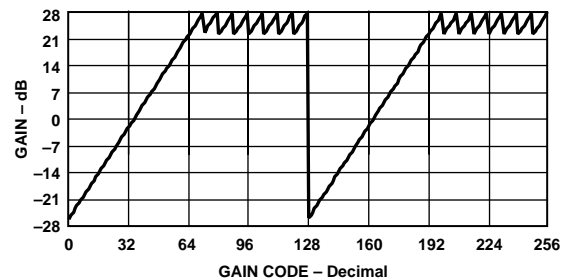

Figure 4. Gain Code vs. Gain

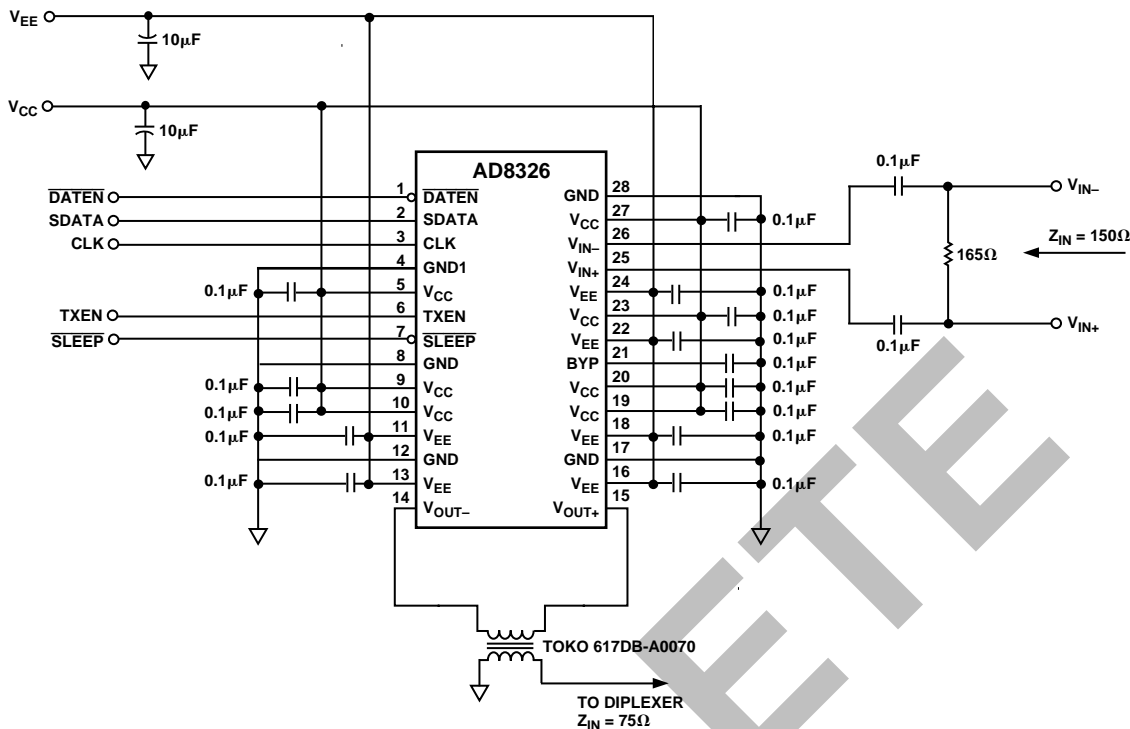

Figure 5. Typical Applications Circuit

Input Bias, Impedance, and Termination

The V_{IN+} and V_{IN-} inputs have a dc bias level of approximately 1.47 V below $V_{CC}/2$, therefore the input signal should be ac-coupled using 0.1 µF capacitors as seen in the typical application circuit (see Figure 5).

The differential input impedance of the AD8326 is approximately 1600 Ω, while the single-ended input is 800 Ω.

Single-Ended Inverting Input

When operating the AD8326 in a single-ended input mode V_{IN+} and V_{IN-} should be terminated as illustrated in Figure 6. On the AD8326 evaluation boards, this termination method requires the removal of R12, R13, R14, R16, R17, and R18. Install a 0 Ω jumper at R15, an 82.5 Ω resistor at R10 for a 75 Ω system, and a 39.2 Ω resistor at R11 to balance the inputs of the AD8326 evaluation board (Figure 11). Other input impedance configurations may be calculated using the equations in Figure 6.

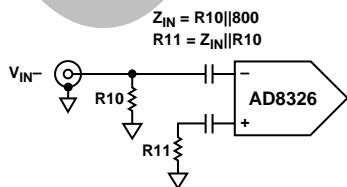

Figure 6. Single-Ended Input Impedance

The inverting and noninverting inputs of the AD8326 must be balanced for all input configurations.

Differential Input from Single-Ended Source

The default configuration of the evaluation board implements a differential signal drive from a single-ended signal source. A

Toko 1:1 transformer is included on the board for this purpose (T3). Enabling the evaluation board for single to differential input conversion requires R15–R17 to be removed, and 0 Ω jumpers must be installed on the placeholders for R13, R14, and R18. For a 75 Ω input impedance, R12 should be 78.7 Ω. Refer to Figure 11 for evaluation board schematic. In this configuration, the input signal must be applied to V_{IN-} . Other input impedances may be calculated using the equation in Figure 7.

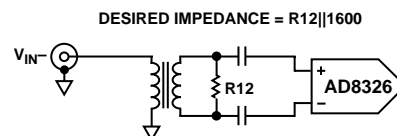

Figure 7. Differential Signal from Single-Ended Source

Differential Signal Source

The AD8326 evaluation board is also capable of accepting a differential input signal. This requires the installation of a 165 Ω resistor in R12, the removal of R13–R14, R17–R18, and the installation of 0 Ω jumpers for R15–R16. This configuration results in a differential input impedance of 150 Ω. Other differential input impedance configurations may be calculated with the equation in Figure 8.

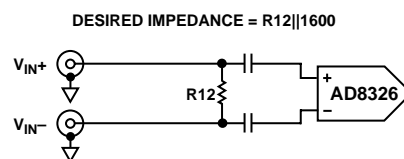

Figure 8. Differential Input

AD8326

Output Bias, Impedance, and Termination

The outputs have a dc bias level of approximately $V_{CC}/2$, therefore they should be ac-coupled before being applied to the load.

The differential output impedance of the AD8326 is internally maintained at $75\ \Omega$, regardless of whether the amplifier is in transmit enable mode or transmit disable mode, eliminating the need for external back termination resistors. A 1:1 transformer is used to couple the amplifier's differential output to the coaxial cable while maintaining a proper impedance match. If the output signal is being evaluated on standard $50\ \Omega$ test equipment, a minimum loss $75\ \Omega$ – $50\ \Omega$ pad must be used to provide the test circuit with proper impedance match.

Single Supply Operation

The 12 V supply should be delivered to each of the V_{CC} pins via a low impedance power bus to ensure that each pin is at the same potential. The power bus should be decoupled to ground using a $10\ \mu\text{F}$ tantalum capacitor located close to the AD8326ARP. In addition to the $10\ \mu\text{F}$ capacitor, each V_{CC} pin should be individually decoupled to ground with $0.1\ \mu\text{F}$ ceramic chip capacitors located close to the pins. The pin labeled BYP (Pin 21) should also be decoupled with a $0.1\ \mu\text{F}$ capacitor. The PCB should have a low-impedance ground plane covering all unused portions of the board, except in the area of the input and output traces in close proximity to the AD8326 and output transformer. All ground and V_{EE} pins of the AD8326ARP must be connected to the ground plane to ensure proper grounding of all internal nodes. Pin 28 and the exposed pad should be connected to ground.

Dual Supply Operation

The +5 V supply power should be delivered to each of the V_{CC} pins via a low impedance power bus to ensure that each pin is at the same potential. The –5 V supply should also be delivered to each of the V_{EE} pins with a low impedance bus. The power buses should be decoupled to ground with a $10\ \mu\text{F}$ tantalum capacitor located close to the AD8326ARE. In addition to the $10\ \mu\text{F}$ capacitor, all V_{CC} , V_{EE} and BYP pins should be individually decoupled to ground with $0.1\ \mu\text{F}$ ceramic chip capacitors located close to the pins. The PCB should have a low-impedance ground plane covering all unused portions of the board, except in the area of the input and output traces in close proximity to the AD8326 and output transformer. All ground pins of the AD8326ARE must be connected to the ground plane to ensure proper grounding of all internal nodes. Pin 28 and the exposed thermal pad should both be tied to ground.

Signal Integrity Layout Considerations

Careful attention to printed circuit board layout details will prevent problems due to board parasitics. Proper RF design technique is mandatory. The differential input and output traces should be kept as short as possible. It is also critical to make sure that all differential signal paths are symmetrical in length and width. In addition, the input and output traces should be kept far apart in order to minimize coupling (crosstalk) through the board. Following these guidelines will improve the overall performance of the AD8326 in all applications.

Thermal Layout Considerations

As integrated circuits become denser, smaller, and more powerful, they often produce more heat. Therefore when designing PC boards, the layout must be able to draw heat away from the higher power devices. The AD8326ARE draws up to 1.5 W when running

at +65 dBmV with $\pm 5\ \text{V}$ supplies. The AD8326ARP draws a maximum of 2 W at +67 dBmV with a +12 V supply.

The following guidelines should be used for both the AD8326ARE and AD8326ARP.

First and foremost, the exposed thermal pad should be soldered directly to a substantial ground plane that adequately absorbs heat away from the AD8326 package. This is the simplest, and most important step in thermally managing the power dissipated in the AD8326. Increasing the area of copper beneath the AD8326 will lower the thermal resistance in the PCB and more effectively allow air to remove the heat from the PCB, and consequently, from the AD8326.

Secondly, thermal stitching is a method for increasing thermal capacity of the PCB. Additionally, thermal stitching can be used to provide a thermally efficient area onto which the AD8326 may be soldered. Thermal stitching is accomplished by using a number of plated through holes (or vias) densely populated in the solder pad area (but not confined to the size of the TSSOP or PSOP2 exposed thermal pad). This technique maximizes the copper area where the package is attached to the PCB increasing the thermal mass or capacity by utilizing more than one copper plane. This method of thermal management should be applied in close proximity to the exposed thermal pad.

Another important guideline is to utilize a multilayer PCB with the AD8326. Lowering the PCB thermal resistance using several layers will generally increase thermal mass resulting in cooler junction temperatures.

Using the techniques described above and dedicating 2.9 square inches of thermally enhanced PCB area, the AD8326 in either package can operate at safe junction temperatures. Figures 12-17 show the above practices in use on the AD8326ARE-EVAL board.

Initial Power-Up

When the supply is first applied to the AD8326, the gain setting of the amplifier is indeterminate. Therefore, as power is first applied to the amplifier, the TXEN pin should be held low (Logic 0), preventing forward signal transmission. After power has been applied to the amplifier, the gain can be set to the desired level by following the procedure in the SPI Programming and Gain Adjustment section. The TXEN pin can then be brought from Logic 0 to Logic 1, enabling forward signal transmission at the desired gain level.

Asynchronous Power-Down

The asynchronous TXEN pin is used to place the AD8326 into "Between Burst" mode while maintaining a differential output impedance of $75\ \Omega$. Applying Logic 0 to the TXEN pin activates the on-chip reverse amplifier, providing a 72% reduction in consumed power. For 12 V operation, the supply current is typically reduced from 159 mA to 44 mA. In this mode of operation, between burst noise is minimized and the amplifier can no longer transmit in the upstream direction. In addition to the TXEN pin, the AD8326 also incorporates an asynchronous SLEEP pin, which may be used to further reduce the supply current to approximately 4 mA. Applying Logic 0 to the SLEEP pin places the amplifier into SLEEP mode. Transitioning into or out of SLEEP mode will result in a transient voltage at the output of the amplifier.

Distortion, Adjacent Channel Power, and DOCSIS

In order to deliver +58 dBmV of high fidelity output power required by DOCSIS, the PA is required to deliver up to +67 dBmV. This added power is required to compensate for losses associated with the transformer, diplexer, directional coupler, and splitters that may be included in the upstream path of the cable telephony. It should be noted that the AD8326 was characterized with the TOKO 617DB-A0070 transformer. TPC 7, TPC 8, TPC 13, and TPC 14 show the AD8326 second and third harmonic distortion performance versus fundamental frequency for various output power levels. These figures are useful for determining the in band harmonic levels from 5 MHz to 65 MHz. Harmonics higher in frequency will be sharply attenuated by the low-pass filter function of the diplexer.

Another measure of signal integrity is adjacent channel power, commonly referred to as ACP. DOCSIS section 4.2.10.1.1 states, "Spurious emissions from a transmitted carrier may occur in an adjacent channel that could be occupied by a carrier of the same or different symbol rates." TPC 9 shows the measured ACP for a +67 dBmV 16 QAM signal taken at the output of the AD8326 evaluation board, through a 75 Ω to 50 Ω matching pad (5.7 dB of loss). The transmit channel width and adjacent channel width in TPC 9 correspond to symbol rates of 160 KSYM/SEC. Table I shows the ACP results for the AD8326 for all conditions in DOCSIS Table 4-7 "Adjacent Channel Spurious Emissions."

Table I. Adjacent Channel Power

Adjacent Channel Symbol Rate					
Transmit Symbol Rate	160K/s ACP (dBc)	320K/s ACP (dBc)	640K/s ACP (dBc)	1280K/s ACP (dBc)	2560K/s ACP (dBc)
160K/s	-57	-59	-62	-63	-64
320K/s	-57	-58	-60	-62	-64
640K/s	-55	-58	-58	-60	-62
1280K/s	-55	-57	-58	-58	-60
2560K/s	-53	-56	-57	-57	-57

Noise and DOCSIS

At minimum gain, the AD8326 output noise spectral density is 13.3 nV/ $\sqrt{\text{Hz}}$ measured at 10 MHz. DOCSIS Table 4-8, "Spurious Emissions in 5 MHz to 42 MHz," specifies the output noise for various symbol rates. The calculated noise power in dBmV for 160 KSYM/SECOND is:

$$\left[20 \times \log \left(\sqrt{\left(\frac{13.3 \text{ nV}}{\sqrt{\text{Hz}}} \right)^2 \times 160 \text{ kHz}} \right) \right] + 60 = -45.5 \text{ dBmV}$$

Comparing the computed noise power of -45.5 dBmV to the +8 dBmV signal yields -53.5 dBc, which meets the required level set forth in DOCSIS Table 4-8. As the AD8326 gain is increased from this minimum value, the output signal increases at a faster

rate than the noise, resulting in a signal to noise ratio that improves with gain. In transmit disable mode, the output noise spectral density is 1.4 nV/ $\sqrt{\text{Hz}}$, which results in -65 dBmV when computed over 160_{KSYM/SECOND}.

The noise power was measured directly at the output of the transformer. In a typical cable telephony application there will be a 6 dB pad, or splitter, which will further attenuate the noise by 6 dB.

Evaluation Board Features and Operation

The AD8326 evaluation boards (Part # AD8326ARE-EVAL and AD8326ARP-EVAL) and control software can be used to control the AD8326 upstream cable driver via the parallel port of a PC. A standard printer cable connected between the parallel port and the evaluation board is used to feed all the necessary data to the AD8326 by means of the Windows 9X-based control software. This package provides a means of evaluating the amplifier by providing a convenient way to program the gain/attenuation as well as offering easy control of the asynchronous TXEN and SLEEP pins. With this evaluation kit, the AD8326 can be evaluated in either a single-ended or differential input configuration. The amplifier can also be evaluated with or without the PULSE diplexer in the output signal path. A schematic of the evaluation board is provided in Figure 11.

Output Transformer and Diplexer

A 1:1 transformer is needed to couple the differential outputs of the AD8326 to the cable while maintaining a proper impedance match. The specified transformer is available from TOKO (Part # 617DB-A0070); however, M/A-COM part # ETC-1-1T may also be used. The evaluation board is equipped with the TOKO transformer, but is also designed to accept the M/A-COM transformer. The PULSE diplexer included on the evaluation board provides a high-order low-pass filter function, typically used in the upstream path. To remove the diplexer from the signal path, remove the 0 Ω chip resistors at R7 and R19, and install a 0 Ω chip resistor at R6 so the output signal is directed away from the diplexer and toward the CABLE port of the evaluation board (Figure 11). The ability of the PULSE diplexer to achieve DOCSIS compliance is neither expressed nor implied by Analog Devices Inc. Data on the diplexer should be obtained from PULSE. When using the diplexer, be sure to properly terminate the cable port (75 Ω) so that the AD8326 draws minimal current.

Overshoot on PC Printer Ports

The data lines on some PC parallel printer ports have excessive overshoot that may cause communications problems when presented to the CLK pin of the AD8326. The evaluation board was designed to accommodate a series resistor and shunt capacitor (R2 and C2 in Figure 11) to filter the CLK signal if required.

Installing Visual Basic Control Software

Install the "CabDrive_26" software by running "setup.exe" on disk one of the AD8326 Evaluation Software. Follow on-screen directions and insert disk two when prompted. Choose installation directory, and then select the icon in the upper left to complete installation.

AD8326

Running AD8326 Software

To load the control software, go to START, PROGRAMS, CABDRIVE_26, or select the AD8326.exe from the installed directory. Once loaded, select the proper parallel port to communicate with the AD8326 (Figure 9).

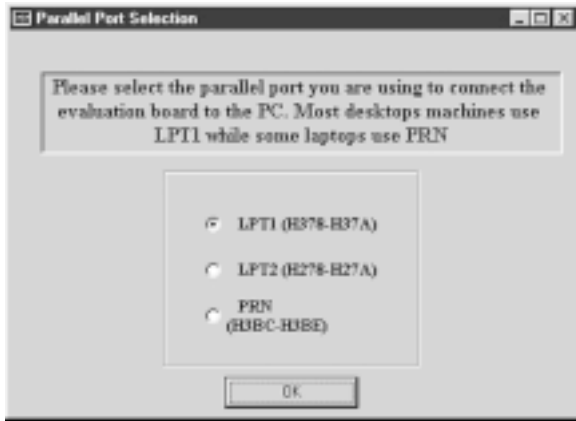

Figure 9. Parallel Port Selection

Controlling Gain/Attenuation of the AD8326

The slide bar controls the gain/attenuation of the AD8326, which is displayed in dB and in V/V. The gain scales 0.75 dB per LSB with valid codes from 0 to 71. The gain code from the position of the slide bar is displayed in decimal, binary, and hexadecimal (Figure 10).

Transmit Enable and Sleep Mode

The Transmit Enable and Transmit Disable buttons select the mode of operation of the AD8326 by asserting logic levels on the asynchronous TXEN pin. The Transmit Disable button applies Logic 0 to the TXEN pin, disabling forward transmission while maintaining a 75 Ω back termination. The Transmit Enable button applies Logic 1 to the TXEN pin, enabling the AD8326 for forward transmission. Checking the “Enable SLEEP Mode” checkbox applies logic “0” to the asynchronous SLEEP pin, setting the AD8326 for SLEEP mode.

Memory Functions

The MEMORY section of the software provides a way to alternate between two gain settings. The “X->M1” button stores the current value of the gain slide bar into memory while the “RM1” button recalls the stored value, returning the gain slide bar to the stored level. The same applies to the “X->M2” and “RM2” buttons.

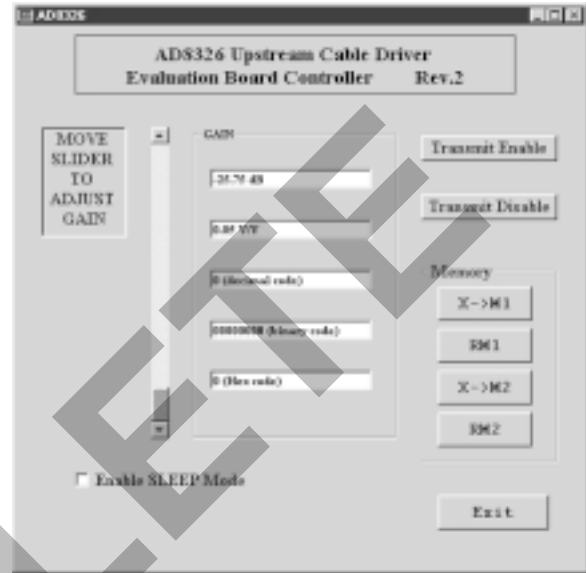

Figure 10. Control Software Interface

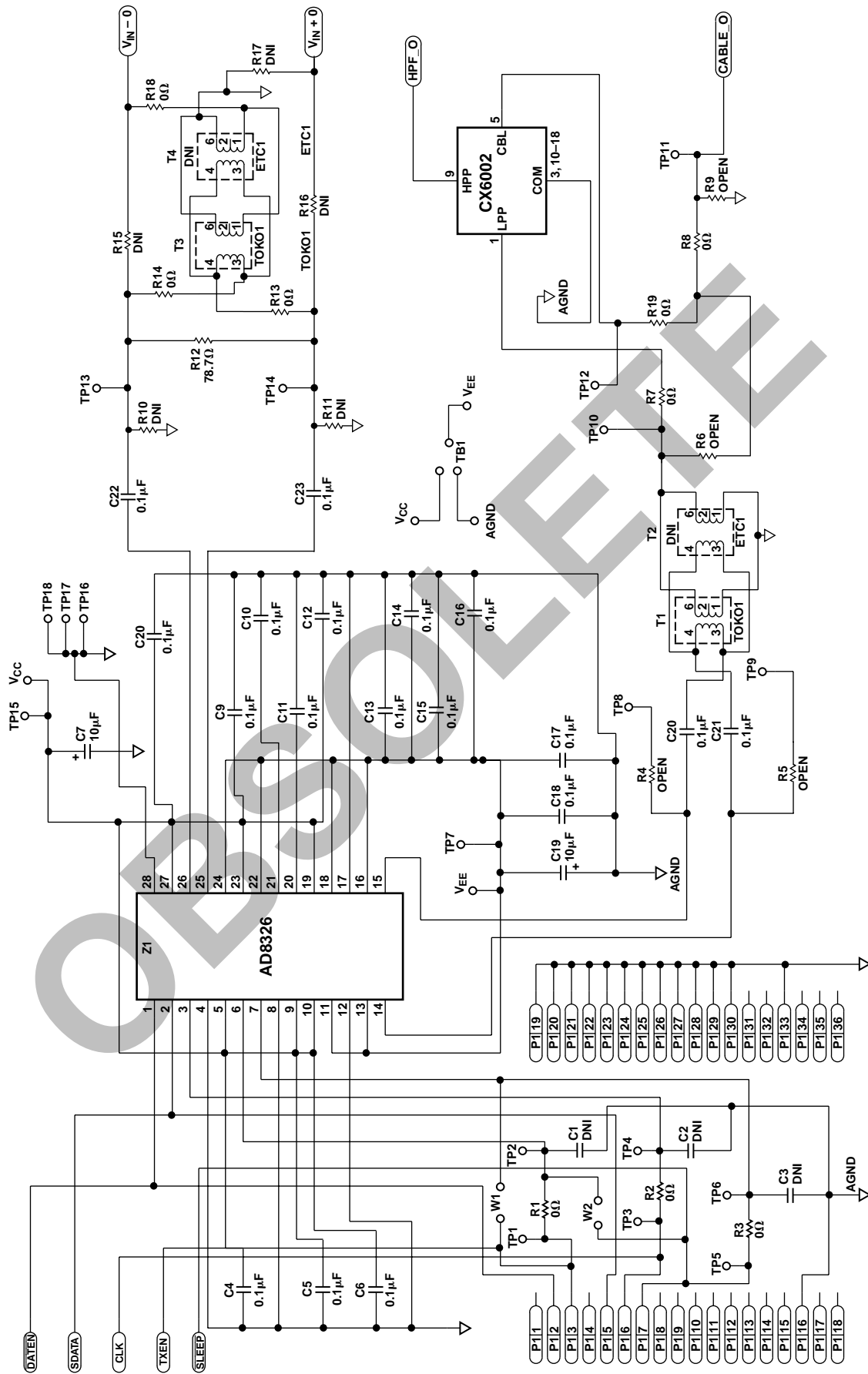

Figure 11. Evaluation Board Schematic

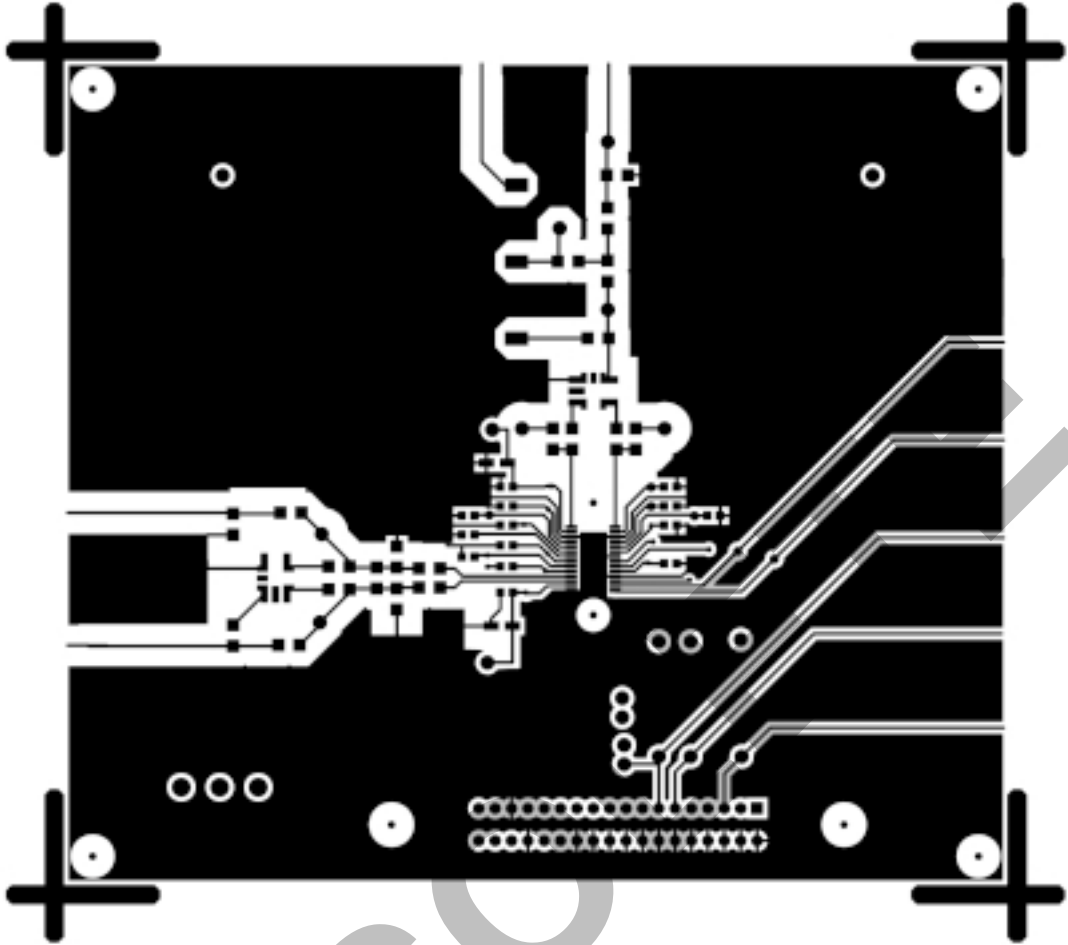

Figure 12. Evaluation Board Layout (Component Side)

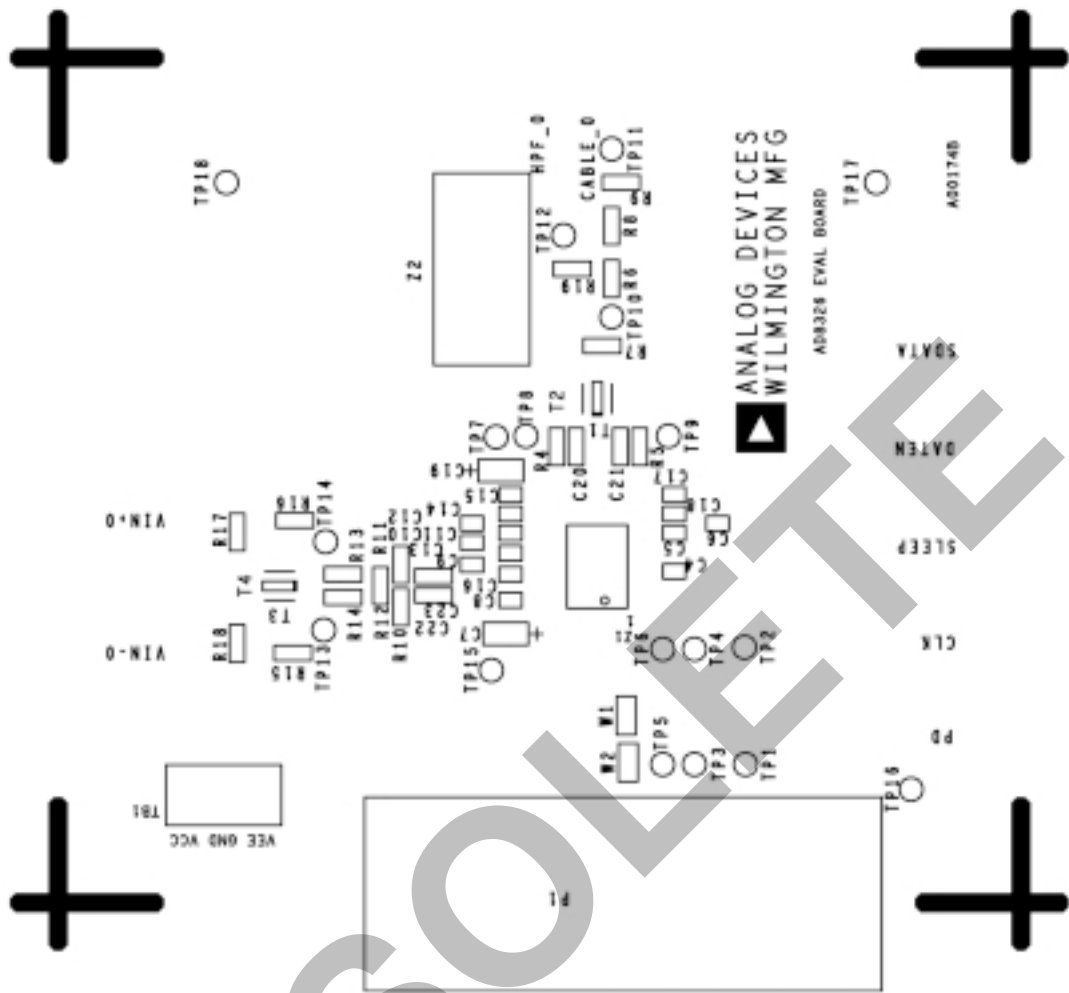

Figure 13. Evaluation Board Layout (Silkscreen Top)

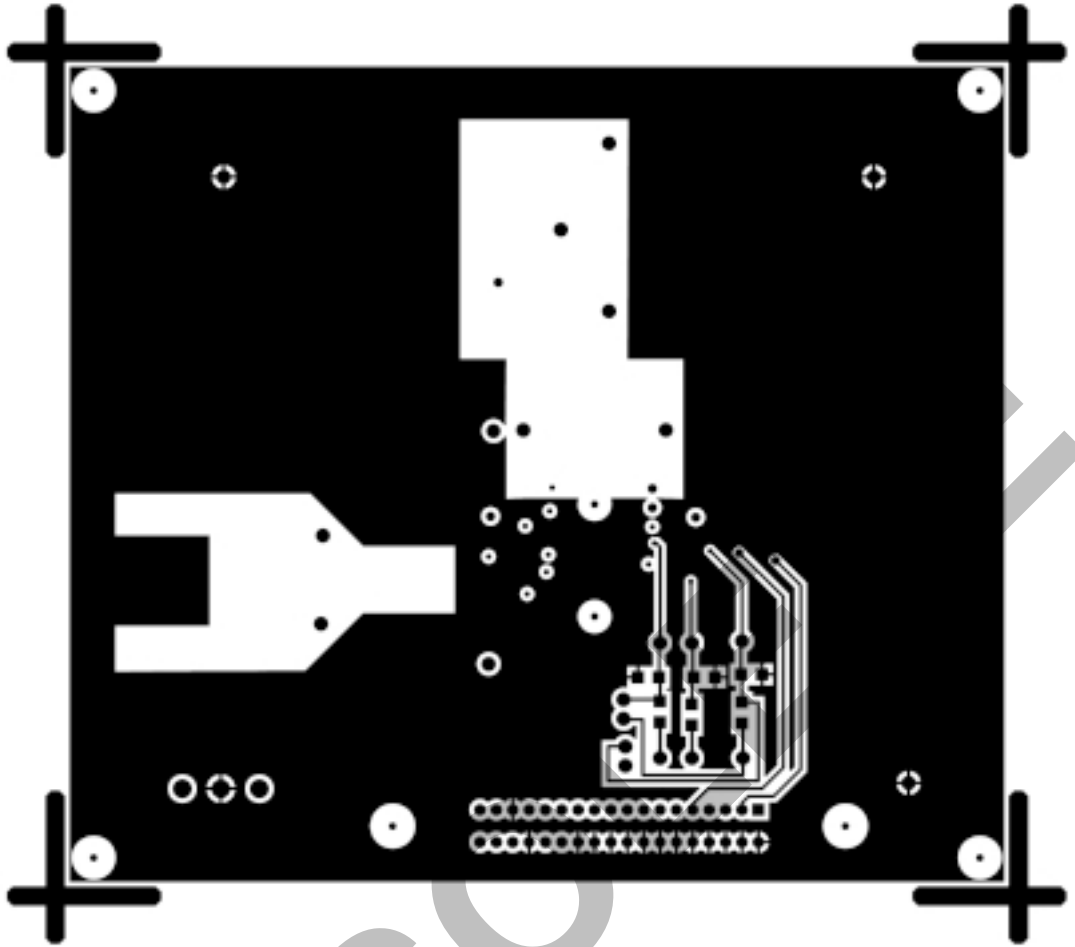

Figure 14. Evaluation Board Layout (Circuit Side)



OBSOLETE

Figure 15. Evaluation Board Layout (Silkscreen Bottom)

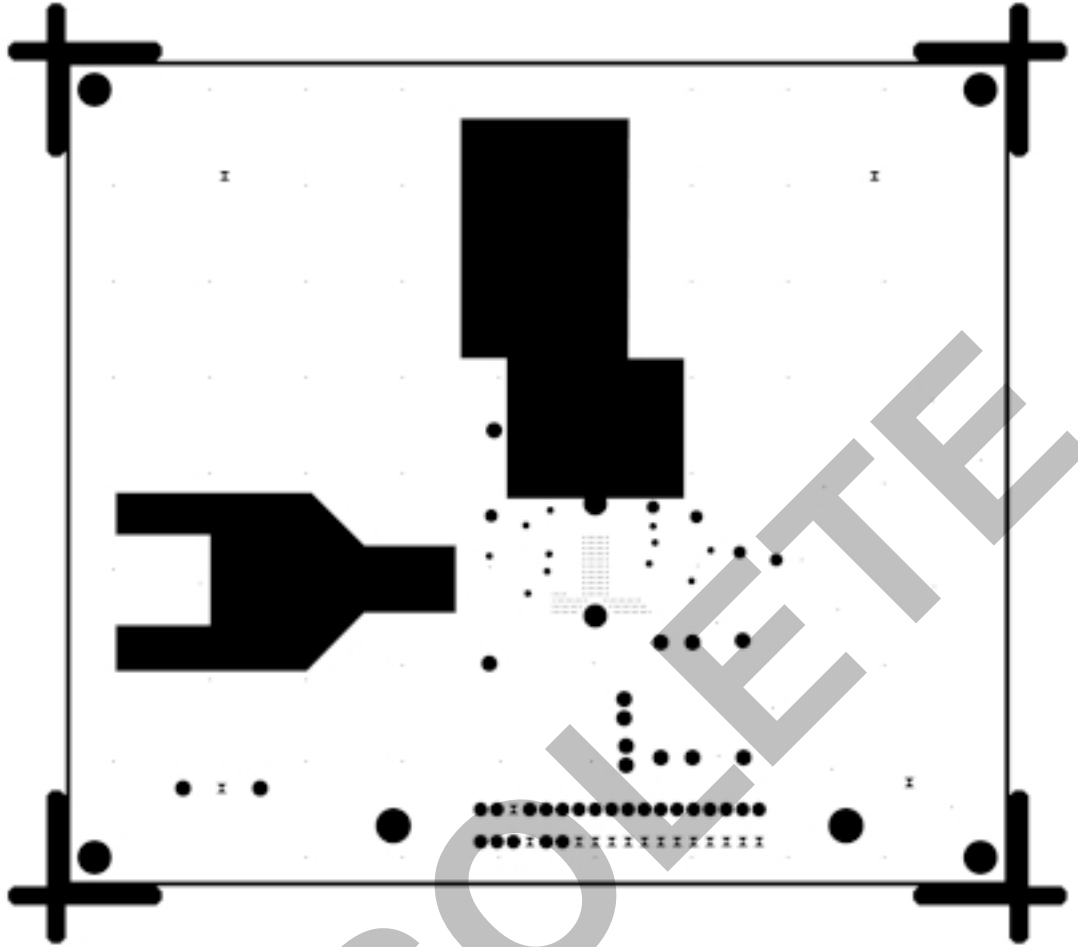

Figure 16. Evaluation Board Layout (Internal Ground Plane)

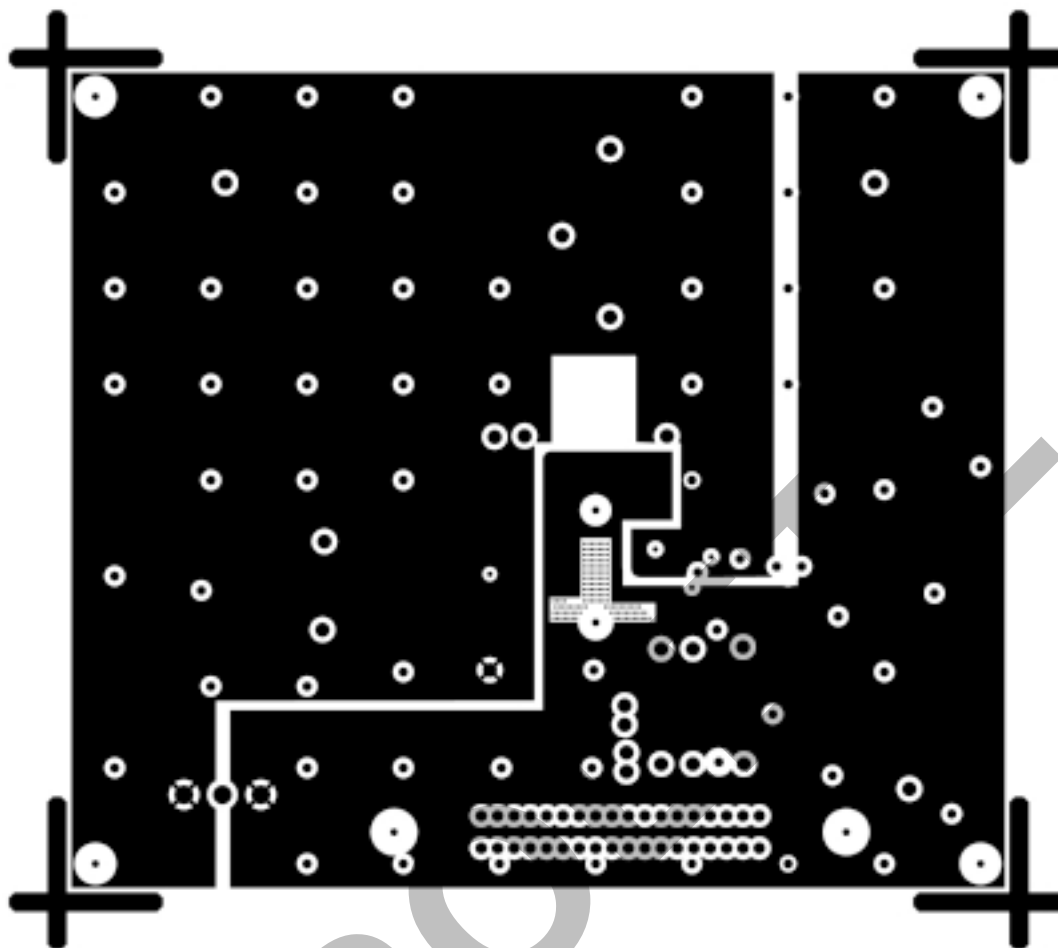

Figure 17. Evaluation Board Layout (Internal Power Planes)

AD8326

AD8326 Evaluation Board Rev. B - Revised - November 22, 2000

Qty.	Description	Vendor	Ref Description
2	10 μ F 16 V. B Size Tantalum Chip Capacitor	ADS# 4-7-24	C7, C19
4	0.1 μ F 50 V. 1206 Size Ceramic Chip Capacitor	ADS# 4-5-18	C20-23
14	0.1 μ F 25 V. 603 Size Ceramic Chip Capacitor	ADS# 4-12-8	C4-C6, C8-C18
9	0 Ω 1/8 W. 1206 Size Chip Resistor	ADS# 3-18- 88	R1-R3, R7, R8, R13, R14, R18, R19
1	78.7 Ω 1% 1/8 W. 1206 Size Chip Resistor	ADS# 3-18-194	R12
2	Yellow Test Point [INPUTS] (Bisco TP104-01-04)	ADS# 12-18-32	TP13, TP14
6	White Test Point [DATA] (Bisco TP104-0 -09)	ADS# 12-18-42	TP1-TP6
1	Red Test Point [VCC] (Bisco TP104-01-02)	ADS# 12-18-43	TP15
1	Blue Test Point [VEE] (Bisco TP104-01-06)	ADS# 12-18-62	TP7
3	Black Test Point [AGND] (Bisco TP104-01-00)	ADS# 12-18-44	TP16-TP18
4	End Launch SMA Connector	ADS# 12-1-31	VIN-, VIN+, CABLE, HPF
1	Centronics Type 36 Pin Right-Angle Connector	ADS# 12-3-50	P1
1	3 Terminal Power Block (Green)	ADS# 12-19-14	TB1
1	1:1 Transformer TOKO # 617DB - A0070	TOKO	T3, T1
1	Pulse # CX 6002 Diplexer	PULSE	Z2
1	AD 8326ARE (TSSOP ePad) UPSTREAM Cable Driver	ADI# AD8326XRE	Z1
1	AD 8326ARE REV. B Evaluation PC Board	ADI# AD8326XRE-EVAL	EVAL PCB
4	#4-40 \times 1/4 Inch STAINLESS Panhead Machine Screw	ADS# 30-1-1	
4	#4-40 \times 3/4 Inch Long Aluminum Round Standoff	ADS# 30-16-3	
2	# 2-56 \times 3/8 inch STAINLESS Panhead Machine Screw	ADS# 30-1-17	(p1 hardware)
2	# 2 Steel Flat Washer	ADS# 30-6-6	(p1 Hardware)
2	# 2 Steel Internal Tooth Lockwasher	ADS# 30-5-2	(p1 Hardware)
2	# 2 STAINLESS STEEL Hex. Machine Nut	ADS# 30-7-6	(p1 Hardware)

Do not install C1-C3, R4-R6, R10, R11, R15-R17, T2, T4, TP8-TP12, W1-W2.

OUTLINE DIMENSIONS

Dimensions shown in inches and (mm).

**28-Lead PSOP
(RP-28)**

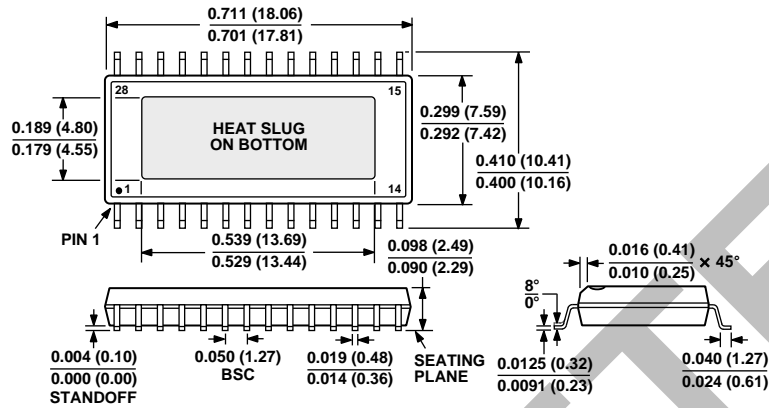

**28-Lead HTSSOP
(RE-28)**

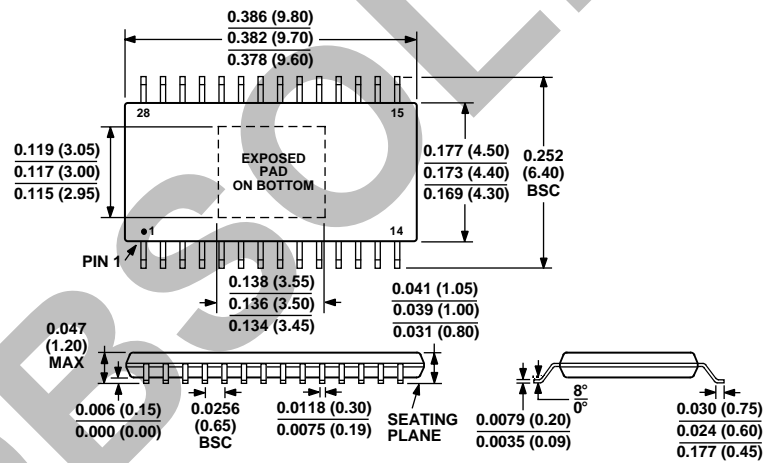

CONTROLLING DIMENSIONS ARE IN MILLIMETERS (mm)

OBSOLETE