



FEATURES

- 1.8 V AFETG core
- Internal LDO regulators
- 24 programmable vertical clock signals
- Correlated double sampler (CDS) with
 - 3 dB, 0 dB, +3 dB, and +6 dB gain
- 6 dB to 42 dB, 10-bit variable gain amplifier (VGA)
- 14-bit, 32 MHz analog-to-digital converter (ADC)
- Black level clamp with variable level control
- Complete on-chip timing generator
- Precision Timing core with ~488 ps resolution
- On-chip 3 V horizontal and RG drivers
- General-purpose outputs (GPOs) for shutter and system support
- On-chip driver for external crystal
- On-chip sync generator with external sync input
- 112-ball CSP_BGA package, 8 mm x 8 mm, 0.65 mm pitch

APPLICATIONS

Digital still cameras

GENERAL DESCRIPTION

The AD9990 is a highly integrated CCD signal processor for digital still camera applications. It includes a complete analog front end with analog-to-digital conversion and a full-function, programmable timing generator for a 2-channel output CCD. Each channel is specified up to 32 MHz. The timing generator is capable of supporting up to 24 vertical clock signals to control advanced CCDs. A Precision Timing® core allows adjustment of high speed clocks with ~488 ps resolution at 32 MHz operation. The AD9990 also contains eight general-purpose outputs that can be used for shutter and system functions.

Each analog front end includes black level clamping, a CDS, a VGA, and a 14-bit ADC. The timing generator provides all the necessary CCD clocks: RG, H-clocks, V-clocks, sensor gate pulses, substrate clock, and substrate bias control.

The AD9990 is specified over an operating temperature range of -25°C to +85°C.

For more information about the AD9990, contact Analog Devices via email at afe.ccd@analog.com.

FUNCTIONAL BLOCK DIAGRAM

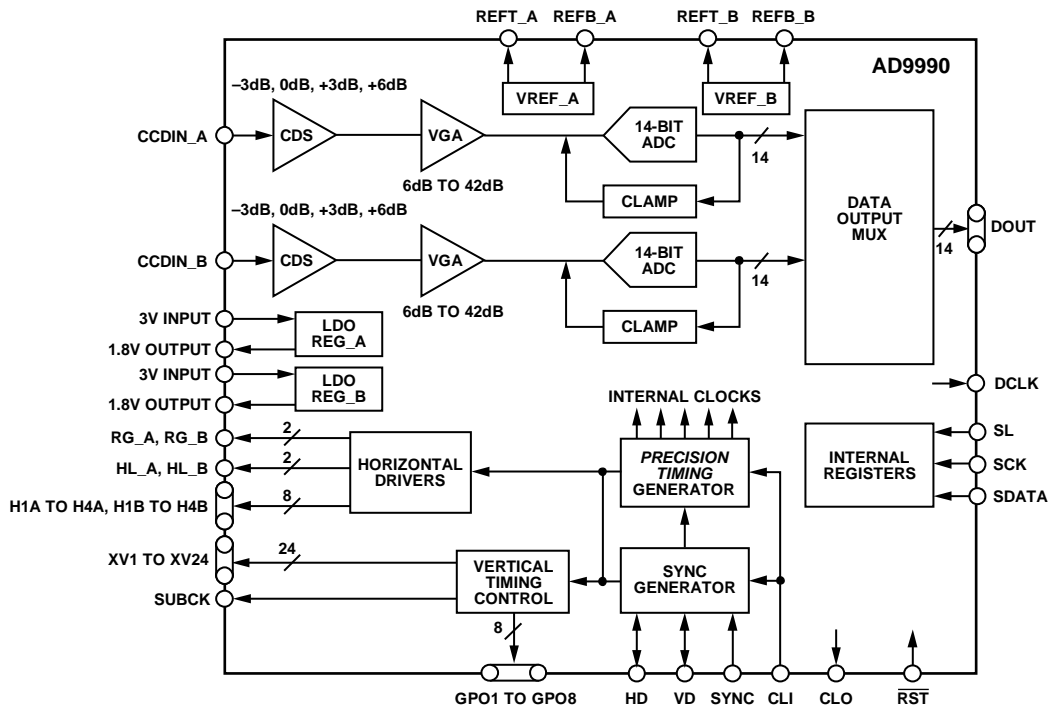

Figure 1.

06894-001

Rev. SpB

Information furnished by Analog Devices is believed to be accurate and reliable. However, no responsibility is assumed by Analog Devices for its use, nor for any infringements of patents or other rights of third parties that may result from its use. Specifications subject to change without notice. No license is granted by implication or otherwise under any patent or patent rights of Analog Devices. Trademarks and registered trademarks are the property of their respective owners.

AD9990

NOTES