

ADC12DL065 Dual 12-Bit, 65 MSPS, 3.3V, 360mW A/D Converter

Check for Samples: [ADC12DL065](#)

FEATURES

- Single +3.3V Supply operation
- Internal Sample-and-Hold
- Internal Reference
- Outputs 2.4V to 3.6V Compatible
- Power Down Mode
- Duty Cycle Stabilizer
- Multiplexed Output Mode

APPLICATIONS

- Ultrasound and Imaging
- Instrumentation
- Communications Receivers
- Sonar/Radar
- xDSL
- Cable Modems
- DSP Front Ends

KEY SPECIFICATIONS

- Resolution: 12 Bits
- DNL: ± 0.4 LSB (typ)
- SNR ($f_{IN} = 10$ MHz): 69 dB (typ)
- SFDR ($f_{IN} = 10$ MHz): 86 dB (typ)
- Data Latency: 7 Clock Cycles
- Power Consumption
 - Operating: 360 mW (typ)
 - Power Down Mode: 36 mW (typ)

DESCRIPTION

The ADC12DL065 is a dual, low power monolithic CMOS analog-to-digital converter capable of converting analog input signals into 12-bit digital words at 65 Megasamples per second (MSPS). This converter uses a differential, pipeline architecture with digital error correction and an on-chip sample-and-hold circuit to minimize power consumption while providing excellent dynamic performance and a 250 MHz Full Power Bandwidth. Operating on a single +3.3V power supply, the ADC12DL065 achieves 11.0 effective bits at nyquist and consumes just 360 mW at 65 MSPS, including the reference current. The Power Down feature reduces power consumption to 36 mW.

The differential inputs provide a full scale differential input swing equal to 2 times V_{REF} with the possibility of a single-ended input. Full use of the differential input is recommended for optimum performance. The digital outputs from the two ADC's are available on a single multiplexed 12-bit bus or on separate buses. Duty cycle stabilization and output data format are selectable using a quad state function pin. The output data can be set for offset binary or two's complement.

To ease interfacing to lower voltage systems, the digital output driver power pins of the ADC12DL065 can be connected to a separate supply voltage in the range of 2.4V to the analog supply voltage. This device is available in the 64-lead TQFP package and will operate over the industrial temperature range of -40°C to $+85^{\circ}\text{C}$. An evaluation board is available to ease the evaluation process.



Please be aware that an important notice concerning availability, standard warranty, and use in critical applications of Texas Instruments semiconductor products and disclaimers thereto appears at the end of this data sheet.

All trademarks are the property of their respective owners.

Connection Diagram

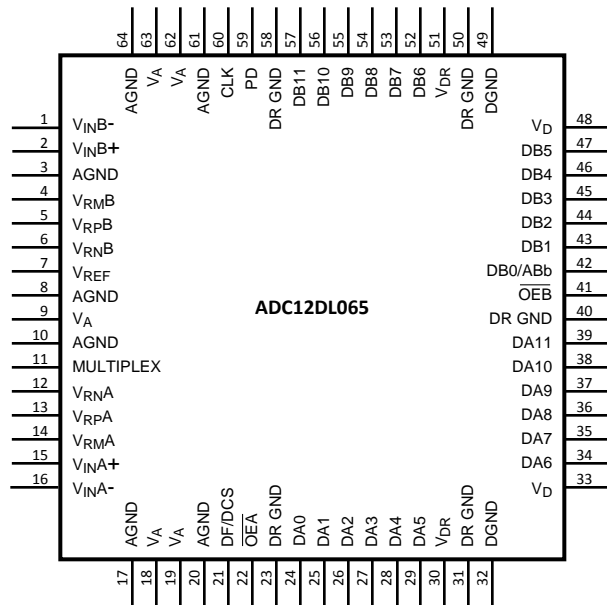
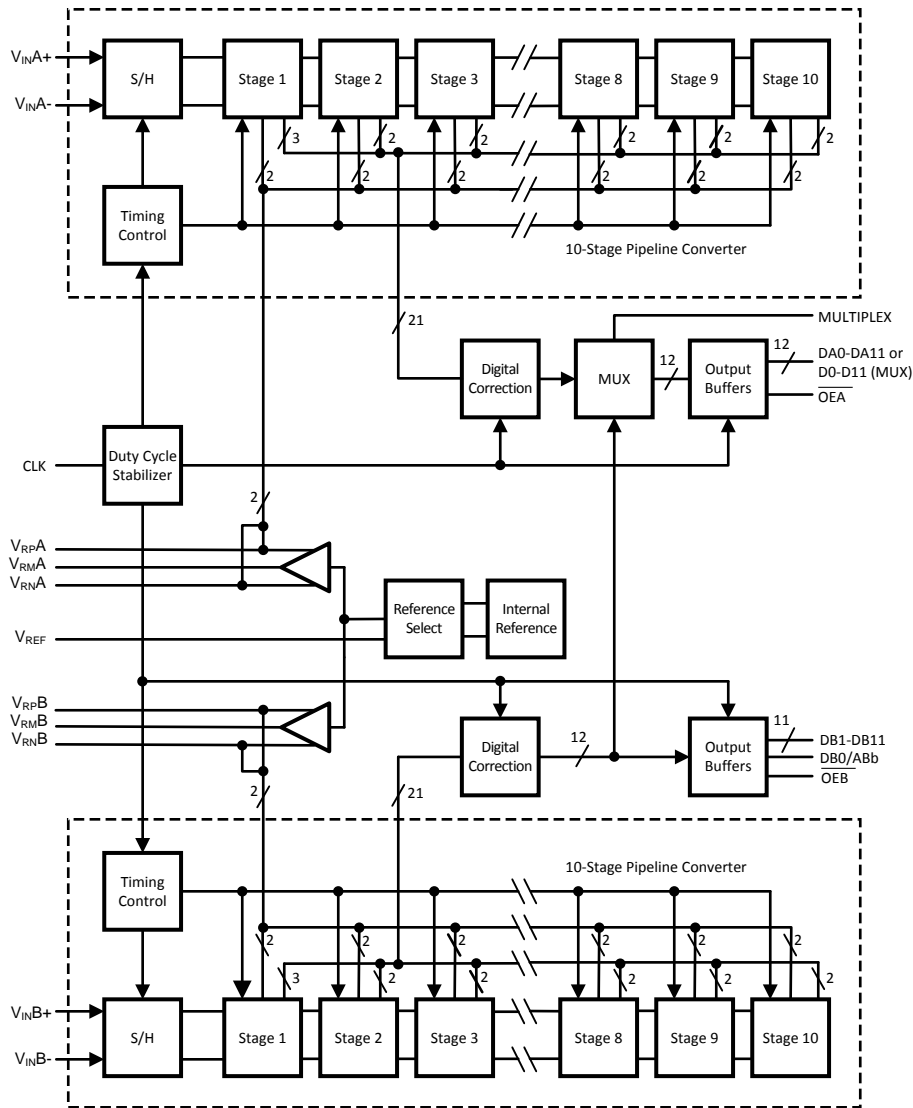

Figure 1. TQFP Package
See Package Number PAG0064A

Block Diagram



Pin Descriptions and Equivalent Circuits

Pin No.	Symbol	Equivalent Circuit	Description
ANALOG I/O			
15 2	$V_{IN A+}$ $V_{IN B+}$		Differential analog input pins. With a 1.0V reference voltage the differential full-scale input signal level is 2.0 V_{P-P} with each input pin voltage centered on a common mode voltage, V_{CM} . The negative input pins may be connected to V_{CM} for single-ended operation, but a differential input signal is required for best performance.
16 1	$V_{IN A-}$ $V_{IN B-}$		
7	V_{REF}		This pin is the reference select pin and the external reference input. If $(V_A - 0.3V) < V_{REF} < V_A$, the internal 1.0V reference is selected. If $AGND < V_{REF} < (AGND + 0.3V)$, the internal 0.5V reference is selected. If a voltage in the range of 0.8V to 1.2V is applied to this pin, that voltage is used as the reference. V_{REF} should be bypassed to AGND with a 0.1 μF capacitor when an external reference is used.
21	DF/DCS		This is a four-state pin. DF/DCS = V_A , output data format is offset binary with duty cycle stabilization applied to the input clock DF/DCS = AGND, output data format is 2's complement, with duty cycle stabilization applied to the input clock. DF/DCS = $V_{RM A}$ or $V_{RM B}$, output data is 2's complement without duty cycle stabilization applied to the input clock DF/DCS = "float", output data is offset binary without duty cycle stabilization applied to the input clock.
13 5	$V_{RP A}$ $V_{RP B}$		These pins are high impedance reference bypass pins. All these pins should each be bypassed to ground with a 0.1 μF capacitor. A 10 μF capacitor should be placed between the $V_{RP A}$ and $V_{RN A}$ pins and between the $V_{RP B}$ and $V_{RN B}$ pins. $V_{RM A}$ and $V_{RM B}$ may be loaded to 1mA for use as a temperature stable 1.5V reference. The remaining pins should not be loaded.
14 4	$V_{RM A}$ $V_{RM B}$		
12 6	$V_{RN A}$ $V_{RN B}$		
DIGITAL I/O			

Pin Descriptions and Equivalent Circuits (continued)

Pin No.	Symbol	Equivalent Circuit	Description
60	CLK		Digital clock input. The range of frequencies for this input is as specified in the electrical tables with ensured performance at 65 MHz. The input is sampled on the rising edge.
22 41	$\overline{\text{OEA}}$ $\overline{\text{OEB}}$		$\overline{\text{OEA}}$ and $\overline{\text{OEB}}$ are the output enable pins that, when low, holds their respective data output pins in the active state. When either of these pins is high, the corresponding outputs are in a high impedance state.
59	PD		PD is the Power Down input pin. When high, this input puts the converter into the power down mode. When this pin is low, the converter is in the active mode.
11	MULTIPLEX		When low, "A" & "B" data is present on it's respective data output lines (Parallel Mode). When high, both "A" and "B" channel data is present on the "DA0:DA11" digital outputs (Multiplex Mode). The DB0/ABb pin is used to synchronize the data.
24–29 34–39	DA0–DA11		Digital data output pins that make up the 12-bit conversion results of their respective converters. DA0 and DB0 are the LSBs, while DA11 and DB11 are the MSBs of the output word. Output levels are TTL/CMOS compatible. Optimum loading is < 10pF.
43–47 52–57	DB1–DB11		<p>When MULTIPLEX is low, this is DB0. When MULTIPLEX is high this is the ABb signal, which is used to synchronize the multiplexed data. ABb changes synchronously with the Multiplexed "A" and "B" channels. ABb is "high" when "A" channel data is valid and is "low" when "B" channel data is valid.</p>
42	DB0/ABb		
ANALOG POWER			
9, 18, 19, 62, 63	V_A		Positive analog supply pins. These pins should be connected to a quiet +3.3V source and bypassed to AGND with 0.1 μF capacitors located within 1 cm of these power pins, and with a 10 μF capacitor.
3, 8, 10, 17, 20, 61, 64	AGND		The ground return for the analog supply.
DIGITAL POWER			
33, 48	V_D		Positive digital supply pin. This pin should be connected to the same quiet +3.3V source as is V_A and be bypassed to DGND with a 0.1 μF capacitor located within 1 cm of the power pin and with a 10 μF capacitor.
32, 49	DGND		The ground return for the digital supply.
30, 51	V_{DR}		Positive driver supply pin for the ADC12DL065's output drivers. This pin should be connected to a voltage source of +2.4V to V_D and be bypassed to DR GND with a 0.1 μF capacitor. If the supply for this pin is different from the supply used for V_A and V_D , it should also be bypassed with a 10 μF capacitor. V_{DR} should never exceed the voltage on V_D . All 0.1 μF bypass capacitors should be located within 1 cm of the supply pin.
23, 31, 40, 50, 58	DR GND		The ground return for the digital supply for the ADC12DL065's output drivers. These pins should be connected to the system digital ground, but not be connected in close proximity to the ADC12DL065's DGND or AGND pins. See LAYOUT AND GROUNDING for more details.



These devices have limited built-in ESD protection. The leads should be shorted together or the device placed in conductive foam during storage or handling to prevent electrostatic damage to the MOS gates.

Absolute Maximum Ratings⁽¹⁾⁽²⁾⁽³⁾

V_A, V_D, V_{DR}		4.2V
$ V_A - V_D $		≤ 100 mV
Voltage on Any Input or Output Pin		-0.3V to (V_A or V_D +0.3V)
Input Current at Any Pin ⁽⁴⁾		± 25 mA
Package Input Current ⁽⁴⁾		± 50 mA
Package Dissipation at $T_A = 25^\circ\text{C}$		See ⁽⁵⁾
ESD Susceptibility	Human Body Model ⁽⁶⁾	2500V
	Machine Model ⁽⁶⁾	250V
Soldering Temperature, Infrared, 10 sec. ⁽⁷⁾		235°C
Storage Temperature		-65°C to +150°C
<i>Soldering process must comply with Reflow Temperature Profile specifications. Refer to www.ti.com/packaging.⁽⁷⁾</i>		

- (1) All voltages are measured with respect to GND = AGND = DGND = 0V, unless otherwise specified.
- (2) Absolute Maximum Ratings indicate limits beyond which damage to the device may occur. Operating Ratings indicate conditions for which the device is functional, but do not ensure specific performance limits. For ensured specifications and test conditions, see the Electrical Characteristics. The ensured specifications apply only for the test conditions listed. Some performance characteristics may degrade when the device is not operated under the listed test conditions.
- (3) If Military/Aerospace specified devices are required, please contact the Texas Instruments Sales Office/ Distributors for availability and specifications.
- (4) When the input voltage at any pin exceeds the power supplies (that is, $V_{IN} < \text{AGND}$, or $V_{IN} > V_A$), the current at that pin should be limited to 25 mA. The 50 mA maximum package input current rating limits the number of pins that can safely exceed the power supplies with an input current of 25 mA to two.
- (5) The absolute maximum junction temperature (T_{Jmax}) for this device is 150°C. The maximum allowable power dissipation is dictated by T_{Jmax} , the junction-to-ambient thermal resistance (θ_{JA}), and the ambient temperature, (T_A), and can be calculated using the formula $P_{DMAX} = (T_{Jmax} - T_A) / \theta_{JA}$. In the 64-pin TQFP, θ_{JA} is 50°C/W, so $P_{DMAX} = 2$ Watts at 25°C and 800 mW at the maximum operating ambient temperature of 85°C. Note that the power consumption of this device under normal operation will typically be about 390 mW (360 typical power consumption + 30 mW TTL output loading). The values for maximum power dissipation listed above will be reached only when the device is operated in a severe fault condition (e.g. when input or output pins are driven beyond the power supply voltages, or the power supply polarity is reversed). Obviously, such conditions should always be avoided.
- (6) Human body model is 100 pF capacitor discharged through a 1.5 k Ω resistor. Machine model is 220 pF discharged through 0 Ω .
- (7) Reflow temperature profiles are different for lead-free and non-lead-free packages.

Operating Ratings⁽¹⁾⁽²⁾

Operating Temperature		$-40^\circ\text{C} \leq T_A \leq +85^\circ\text{C}$
Supply Voltage (V_A, V_D)		+3.0V to +3.6V
Output Driver Supply (V_{DR})		+2.4V to V_D
CLK, PD, $\overline{\text{OE}}_A, \overline{\text{OE}}_B$		-0.05V to (V_D + 0.05V)
Analog Input Pins		0V to 2.6V
V_{CM}		0.5V to 2.0V
$ \text{AGND} - \text{DGND} $		≤ 100 mV
Clock Duty Cycle (DCS On)		20% to 80%
Clock Duty Cycle (DCS Off)		40% to 60%

- (1) Absolute Maximum Ratings indicate limits beyond which damage to the device may occur. Operating Ratings indicate conditions for which the device is functional, but do not ensure specific performance limits. For ensured specifications and test conditions, see the Electrical Characteristics. The ensured specifications apply only for the test conditions listed. Some performance characteristics may degrade when the device is not operated under the listed test conditions.
- (2) All voltages are measured with respect to GND = AGND = DGND = 0V, unless otherwise specified.

Converter Electrical Characteristics

Unless otherwise specified, the following specifications apply for AGND = DGND = DR GND = 0V, $V_A = V_D = +3.3V$, $V_{DR} = +2.5V$, PD = 0V, External $V_{REF} = +1.0V$, $f_{CLK} = 65\text{ MHz}$, $f_{IN} = 10\text{ MHz}$, $t_r = t_f = 2\text{ ns}$, $C_L = 15\text{ pF/pin}$, Duty Cycle Stabilizer On, parallel output mode. **Boldface limits apply for $T_J = T_{MIN}$ to T_{MAX}** : all other limits $T_J = 25^\circ\text{C}$ ⁽¹⁾⁽²⁾⁽³⁾

Parameter	Test Conditions	Typical ⁽⁴⁾	Limits ⁽⁴⁾	Units (Limits)	
STATIC CONVERTER CHARACTERISTICS					
	Resolution with No Missing Codes		12	Bits (min)	
INL	Integral Non Linearity ⁽⁵⁾	± 0.75	± 1.7	LSB (max)	
DNL	Differential Non Linearity	± 0.4	± 1.0	LSB (max)	
PGE	Positive Gain Error	± 0.2	± 2.9	%FS (max)	
NGE	Negative Gain Error	± 0.2	± 3.2	%FS (max)	
TC GE	Gain Error Tempco	$-40^\circ\text{C} \leq T_A \leq +85^\circ\text{C}$	10	ppm/ $^\circ\text{C}$	
V_{OFF}	Offset Error ($V_{IN+} = V_{IN-}$)		0.18	%FS (max) %FS (min)	
TC V_{OFF}	Offset Error Tempco	$-40^\circ\text{C} \leq T_A \leq +85^\circ\text{C}$	3.6	ppm/ $^\circ\text{C}$	
	Under Range Output Code		0	0	
	Over Range Output Code		4095	4095	
REFERENCE AND ANALOG INPUT CHARACTERISTICS					
V_{CM}	Common Mode Input Voltage		1.5	0.5 V (min)	
				2.0 V (max)	
V_{RMA} , V_{RMB}	Reference Output Voltage	Output load = 1 mA	1.5	V	
C_{IN}	V_{IN} Input Capacitance (each pin to GND)	$V_{IN} = 2.5\text{ Vdc} + 0.7\text{ V}_{rms}$	(CLK LOW)	8	pF
			(CLK HIGH)	7	pF
V_{REF}	External Reference Voltage ⁽⁶⁾		1.00	0.8 V (min)	
				1.2 V (max)	
	Reference Input Resistance		1	M Ω (min)	

- (1) The inputs are protected as shown below. Input voltage magnitudes above V_A or below GND will not damage this device, provided current is limited per Note 4 of the Absolute Maximum Ratings Table. However, errors in the A/D conversion can occur if the input goes above V_A or below GND by more than 100 mV. As an example, if V_A is +3.3V, the full-scale input voltage must be $\leq +3.4V$ to ensure accurate conversions. See Figure 2.
- (2) To ensure accuracy, it is required that $|V_A - V_D| \leq 100\text{ mV}$ and separate bypass capacitors are used at each power supply pin.
- (3) With the test condition for $V_{REF} = +1.0V$ (2V_{P-P} differential input), the 12-bit LSB is 488 μV .
- (4) Typical figures are at $T_J = 25^\circ\text{C}$, and represent most likely parametric norms. Test limits are ensured to TI's AOQL (Average Outgoing Quality Level).
- (5) Integral Non Linearity is defined as the deviation of the analog value, expressed in LSBs, from the straight line that passes through positive and negative full-scale.
- (6) Optimum performance will be obtained by keeping the reference input in the 0.8V to 1.2V range. The LM4051CIM3-ADJ (SOT-23 package) is recommended for external reference applications.

Converter Electrical Characteristics (continued)

Unless otherwise specified, the following specifications apply for AGND = DGND = DR GND = 0V, $V_A = V_D = +3.3V$, $V_{DR} = +2.5V$, PD = 0V, External $V_{REF} = +1.0V$, $f_{CLK} = 65$ MHz, $f_{IN} = 10$ MHz, $t_r = t_f = 2$ ns, $C_L = 15$ pF/pin, Duty Cycle Stabilizer On, parallel output mode. **Boldface limits apply for $T_J = T_{MIN}$ to T_{MAX}** ; all other limits $T_J = 25^\circ C^{(1)(2)(3)}$

Parameter		Test Conditions	Typical ⁽⁴⁾	Limits ⁽⁴⁾	Units (Limits)
DYNAMIC CONVERTER CHARACTERISTICS					
FPBW	Full Power Bandwidth	0 dBFS Input, Output at -3 dB	250		MHz
SNR	Signal-to-Noise Ratio	$f_{IN} = 1$ MHz, $V_{IN} = -0.5$ dBFS	69		dBc
		$f_{IN} = 10$ MHz, $V_{IN} = -0.5$ dBFS	69	67.5	dBc (min)
		$f_{IN} = 32.5$ MHz, $V_{IN} = -0.5$ dBFS	68.5	67	dBc (min)
SINAD	Signal-to-Noise and Distortion	$f_{IN} = 1$ MHz, $V_{IN} = -0.5$ dBFS	68.5		dBc
		$f_{IN} = 10$ MHz, $V_{IN} = -0.5$ dBFS	68.5	67.5	dBc (min)
		$f_{IN} = 32.5$ MHz, $V_{IN} = -0.5$ dBFS	68	67	dBc (min)
ENOB	Effective Number of Bits	$f_{IN} = 1$ MHz, $V_{IN} = -0.5$ dBFS	11.1		Bits
		$f_{IN} = 10$ MHz, $V_{IN} = -0.5$ dBFS	11.1	10.9	Bits (min)
		$f_{IN} = 32.5$ MHz, $V_{IN} = -0.5$ dBFS	11.0	10.8	Bits (min)
THD	Total Harmonic Distortion	$f_{IN} = 1$ MHz, $V_{IN} = -0.5$ dBFS	-82		dBc
		$f_{IN} = 10$ MHz, $V_{IN} = -0.5$ dBFS	-83.5	-75	dBc (min)
		$f_{IN} = 32.5$ MHz, $V_{IN} = -0.5$ dBFS	-83	-75	dBc (min)
H2	Second Harmonic Distortion	$f_{IN} = 1$ MHz, $V_{IN} = -0.5$ dBFS	-88		dBc
		$f_{IN} = 10$ MHz, $V_{IN} = -0.5$ dBFS	-90	-80	dBc (min)
		$f_{IN} = 32.5$ MHz, $V_{IN} = -0.5$ dBFS	-90	-80	dBc (min)
H3	Third Harmonic Distortion	$f_{IN} = 1$ MHz, $V_{IN} = -0.5$ dBFS	-88		dBc
		$f_{IN} = 10$ MHz, $V_{IN} = -0.5$ dBFS	-86	-78.5	dBc (min)
		$f_{IN} = 32.5$ MHz, $V_{IN} = -0.5$ dBFS	-84	-77	dBc (min)
SFDR	Spurious Free Dynamic Range	$f_{IN} = 1$ MHz, $V_{IN} = -0.5$ dBFS	86		dBc
		$f_{IN} = 10$ MHz, $V_{IN} = -0.5$ dBFS	86	78.5	dBc (min)
		$f_{IN} = 32.5$ MHz, $V_{IN} = -0.5$ dBFS	85	77	dBc (min)
IMD	Intermodulation Distortion	$f_{IN} = 9.6$ MHz and 10.2 MHz, each = -6.0 dBFS	-74		dBFS
INTER-CHANNEL CHARACTERISTICS					
	Channel—Channel Offset Match		±0.3		%FS
	Channel—Channel Gain Match		±4		%FS
	Crosstalk	10 MHz Tested, Channel; 32.5 MHz Other Channel	90		dBc
		10 MHz Tested, Channel; 65 MHz Other Channel	90		dBc

DC and Logic Electrical Characteristics

Unless otherwise specified, the following specifications apply for AGND = DGND = DR GND = 0V, $V_A = V_D = +3.3V$, $V_{DR} = +2.5V$, PD = 0V, External $V_{REF} = +1.0V$, $f_{CLK} = 65\text{ MHz}$, $f_{IN} = 10\text{ MHz}$, $t_r = t_f = 2\text{ ns}$, $C_L = 15\text{ pF/pin}$, Duty Cycle Stabilizer On, parallel output mode. **Boldface limits apply for $T_J = T_{MIN}$ to T_{MAX}** : all other limits $T_J = 25^\circ\text{C}^{(1)(2)(3)}$

Parameter		Test Conditions	Typical ⁽⁴⁾	Limits ⁽⁴⁾	Units (Limits)
CLK, PD, $\overline{OE_A}$, $\overline{OE_B}$ DIGITAL INPUT CHARACTERISTICS					
$V_{IN(1)}$	Logical "1" Input Voltage	$V_D = 3.6V$		2.0	V (min)
$V_{IN(0)}$	Logical "0" Input Voltage	$V_D = 3.0V$		1.0	V (max)
$I_{IN(1)}$	Logical "1" Input Current	$V_{IN} = 3.3V$	10		μA
$I_{IN(0)}$	Logical "0" Input Current	$V_{IN} = 0V$	-10		μA
C_{IN}	Digital Input Capacitance		5		pF
DA0–DA11, DB0–DB11 DIGITAL OUTPUT CHARACTERISTICS					
$V_{OUT(1)}$	Logical "1" Output Voltage	$I_{OUT} = -0.5\text{ mA}$	$V_{DR} = 2.5V$	2.3	V (min)
			$V_{DR} = 3V$	2.7	V (min)
$V_{OUT(0)}$	Logical "0" Output Voltage	$I_{OUT} = 1.6\text{ mA}$, $V_{DR} = 3V$		0.4	V (max)
I_{OZ}	TRI-STATE Output Current	$V_{OUT} = 2.5V$ or $3.3V$	100		nA
		$V_{OUT} = 0V$	-100		nA
$+I_{SC}$	Output Short Circuit Source Current	$V_{OUT} = 0V$	-20		mA
$-I_{SC}$	Output Short Circuit Sink Current	$V_{OUT} = V_{DR}$	20		mA
C_{OUT}	Digital Output Capacitance		5		pF
POWER SUPPLY CHARACTERISTICS					
I_A	Analog Supply Current	PD Pin = DGND, $V_{REF} = V_A$ PD Pin = V_D	90	108	mA (max)
			12		
I_D	Digital Supply Current	PD Pin = DGND PD Pin = V_D , $f_{CLK} = 0$	19	22	mA (max)
			0		
I_{DR}	Digital Output Supply Current	PD Pin = DGND, $C_L = 10\text{ pF}^{(5)}$ PD Pin = V_D , $f_{CLK} = 0$	15		mA
			0		
	Total Power Consumption	PD Pin = DGND, $C_L = 10\text{ pF}^{(6)}$ PD Pin = V_D	360	430	mW (max)
			36		
PSRR1	Power Supply Rejection Ratio	Rejection of Full-Scale Error with $V_A = 3.0V$ vs. $3.6V$	62		dB

- The inputs are protected as shown below. Input voltage magnitudes above V_A or below GND will not damage this device, provided current is limited per [Note 4](#) of the Absolute Maximum Ratings Table. However, errors in the A/D conversion can occur if the input goes above V_A or below GND by more than 100 mV. As an example, if V_A is +3.3V, the full-scale input voltage must be $\leq +3.4V$ to ensure accurate conversions. See [Figure 2](#).
- To ensure accuracy, it is required that $|V_A - V_D| \leq 100\text{ mV}$ and separate bypass capacitors are used at each power supply pin.
- With the test condition for $V_{REF} = +1.0V$ (2V_{P-P} differential input), the 12-bit LSB is 488 μV .
- Typical figures are at $T_J = 25^\circ\text{C}$, and represent most likely parametric norms. Test limits are ensured to TI's AOQL (Average Outgoing Quality Level).
- I_{DR} is the current consumed by the switching of the output drivers and is primarily determined by load capacitance on the output pins, the supply voltage, V_{DR} , and the rate at which the outputs are switching (which is signal dependent). $I_{DR} = V_{DR}(C_0 \times f_0 + C_1 \times f_1 + \dots + C_{11} \times f_{11})$ where V_{DR} is the output driver power supply voltage, C_n is total capacitance on the output pin, and f_n is the average frequency at which that pin is toggling.
- Excludes I_{DR} . See [DC and Logic Electrical Characteristics, Note 5](#).

AC Electrical Characteristics

Unless otherwise specified, the following specifications apply for AGND = DGND = DR GND = 0V, $V_A = V_D = +3.3V$, $V_{DR} = +2.5V$, PD = 0V, External $V_{REF} = +1.0V$, $f_{CLK} = 65\text{ MHz}$, $f_{IN} = 10\text{ MHz}$, $t_r = t_f = 2\text{ ns}$, $C_L = 15\text{ pF/pin}$, Duty Cycle Stabilizer On, parallel output mode. **Boldface limits apply for $T_J = T_{MIN}$ to T_{MAX}** : all other limits $T_J = 25^\circ\text{C}$ ⁽¹⁾⁽²⁾⁽³⁾⁽⁴⁾

Parameter		Test Conditions	Typical ⁽⁵⁾	Limits ⁽⁵⁾	Units (Limits)
f_{CLK}^1	Maximum Clock Frequency			65	MHz (min)
f_{CLK}^2	Minimum Clock Frequency		15		MHz
t_{CH}	Clock High Time	Duty Cycle Stabilizer On	7.7	3	ns (min)
t_{CL}	Clock Low Time	Duty Cycle Stabilizer On	7.7	3	ns (min)
t_r, t_f	Clock Rise and Fall Times	Duty Cycle Stabilizer On	2	4	ns (max)
t_{CH}	Clock High Time	Duty Cycle Stabilizer Off	7.7	6.2	ns (min)
t_{CL}	Clock Low Time	Duty Cycle Stabilizer Off	7.7	6.2	ns (min)
t_r, t_f	Clock Rise and Fall Times	Duty Cycle Stabilizer Off	2		ns (max)
t_{CONV}	Conversion Latency	Parallel mode		7	Clock Cycles
t_{OD}	Data Output Delay after Rising Clock Edge	Parallel mode	6.0	3.5	ns (min)
				9	ns (max)
t_{CONV}	Conversion Latency	Multiplex mode, Channel A		7.5	Clock Cycles
t_{CONV}	Conversion Latency	Multiplex mode, Channel B		8	Clock Cycles
t_{OD}	Data Output Delay after Clock Edge	Multiplex mode	6.0	3.5	ns (min)
				8	ns (max)
t_{SKEW}	ABb to Data Skew		± 0.5		ns (max)
t_{AD}	Aperture Delay		2		ns
t_{AJ}	Aperture Jitter		1.2		ps rms
t_{DIS}	Data outputs into Hi-Z Mode		10		ns
t_{EN}	Data Outputs Active after Hi-Z Mode		10		ns
t_{PD}	Power Down Mode Exit Cycle	1.0 μF on pins 4, 14; 0.1 μF on pins 5,6,12,13; 10 μF between pins 5, 6 and between pins 12, 13	1		μs

- The inputs are protected as shown below. Input voltage magnitudes above V_A or below GND will not damage this device, provided current is limited per Note 4 of the Absolute Maximum Ratings Table. However, errors in the A/D conversion can occur if the input goes above V_A or below GND by more than 100 mV. As an example, if V_A is +3.3V, the full-scale input voltage must be $\leq +3.4V$ to ensure accurate conversions. See Figure 2.
- To ensure accuracy, it is required that $|V_A - V_D| \leq 100\text{ mV}$ and separate bypass capacitors are used at each power supply pin.
- With the test condition for $V_{REF} = +1.0V$ (2V_{P-P} differential input), the 12-bit LSB is 488 μV .
- Timing specifications are tested at TTL logic levels, $V_{IL} = 0.4V$ for a falling edge and $V_{IH} = 2.4V$ for a rising edge.
- Typical figures are at $T_J = 25^\circ\text{C}$, and represent most likely parametric norms. Test limits are ensured to TI's AOQL (Average Outgoing Quality Level).

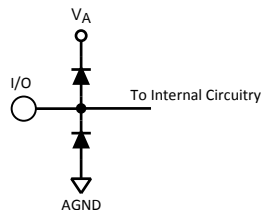

Figure 2.

Specification Definitions

APERTURE DELAY is the time after the rising edge of the clock to when the input signal is acquired or held for conversion.

APERTURE JITTER (APERTURE UNCERTAINTY) is the variation in aperture delay from sample to sample. Aperture jitter manifests itself as noise in the output.

CLOCK DUTY CYCLE is the ratio of the time during one cycle that a repetitive digital waveform is high to the total time of one period. The specification here refers to the ADC clock input signal.

COMMON MODE VOLTAGE (V_{CM}) is the common d.c. voltage applied to both input terminals of the ADC.

CONVERSION LATENCY is the number of clock cycles between initiation of conversion and when that data is presented to the output driver stage. Data for any given sample is available at the output pins the Pipeline Delay plus the Output Delay after the sample is taken. New data is available at every clock cycle, but the data lags the conversion by the pipeline delay.

CROSSTALK is coupling of energy from one channel into the other channel.

DIFFERENTIAL NON-LINEARITY (DNL) is the measure of the maximum deviation from the ideal step size of 1 LSB.

EFFECTIVE NUMBER OF BITS (ENOB, or EFFECTIVE BITS) is another method of specifying Signal-to-Noise and Distortion or SINAD. ENOB is defined as $(\text{SINAD} - 1.76) / 6.02$ and says that the converter is equivalent to a perfect ADC of this (ENOB) number of bits.

FULL POWER BANDWIDTH is a measure of the frequency at which the reconstructed output fundamental drops 3 dB below its low frequency value for a full scale input.

GAIN ERROR is the deviation from the ideal slope of the transfer function. It can be calculated as:

$$\text{Gain Error} = \text{Positive Full Scale Error} - \text{Offset Error} \quad (1)$$

A gain of unity occurs when the negative and positive full scale errors are equal to each other, including having the same sign.

GAIN ERROR MATCHING is the difference in gain errors between the two converters divided by the average gain of the converters.

INTEGRAL NON LINEARITY (INL) is a measure of the deviation of each individual code from a line drawn from negative full scale ($\frac{1}{2}$ LSB below the first code transition) through positive full scale ($\frac{1}{2}$ LSB above the last code transition). The deviation of any given code from this straight line is measured from the center of that code value.

INTERMODULATION DISTORTION (IMD) is the creation of additional spectral components as a result of two sinusoidal frequencies being applied to the ADC input at the same time. It is defined as the ratio of the power in the intermodulation products to the total power in the original frequencies. IMD is usually expressed in dBFS.

LSB (LEAST SIGNIFICANT BIT) is the bit that has the smallest value or weight of all bits. This value is $V_{FS}/2^n$, where “ V_{FS} ” is the full scale input voltage and “ n ” is the ADC resolution in bits.

MISSING CODES are those output codes that will never appear at the ADC outputs. The ADC12DL065 is ensured not to have any missing codes.

MSB (MOST SIGNIFICANT BIT) is the bit that has the largest value or weight. Its value is one half of full scale.

NEGATIVE FULL SCALE ERROR is the difference between the actual first code transition and its ideal value of $\frac{1}{2}$ LSB above negative full scale.

OFFSET ERROR is the difference between the two input voltages $[(V_{IN+}) - (V_{IN-})]$ required to cause a transition from code 2047 to 2048.

OUTPUT DELAY is the time delay after the rising edge of the clock before the data update is presented at the output pins.

OVER RANGE RECOVERY TIME is the time required after V_{IN} goes from a specified voltage out of the normal input range to a specified voltage within the normal input range and the converter makes a conversion with its rated accuracy.

PIPELINE DELAY (LATENCY) See [CONVERSION LATENCY](#).

POSITIVE FULL SCALE ERROR is the difference between the actual last code transition and its ideal value of 1½ LSB below positive full scale.

POWER SUPPLY REJECTION RATIO (PSRR) is a measure of how well the ADC rejects a change in the power supply voltage. For the ADC12DL065, PSRR1 is the ratio of the change in Full-Scale Error that results from a change in the d.c. power supply voltage, expressed in dB. PSRR2 is a measure of how well an a.c. signal riding upon the power supply is rejected at the output.

SIGNAL TO NOISE RATIO (SNR) is the ratio, expressed in dB, of the rms value of the input signal to the rms value of the sum of all other spectral components below one-half the sampling frequency, not including harmonics or d.c.

SIGNAL TO NOISE PLUS DISTORTION (S/N+D or SINAD) Is the ratio, expressed in dB, of the rms value of the input signal to the rms value of all of the other spectral components below half the clock frequency, including harmonics but excluding d.c.

SPURIOUS FREE DYNAMIC RANGE (SFDR) is the difference, expressed in dB, between the rms values of the input signal and the peak spurious signal, where a spurious signal is any signal present in the output spectrum that is not present at the input.

TOTAL HARMONIC DISTORTION (THD) is the ratio, expressed in dB, of the rms total of the first nine harmonic levels at the output to the level of the fundamental at the output. THD is calculated as

$$\text{THD} = 20 \times \log \sqrt{\frac{f_2^2 + \dots + f_{10}^2}{f_1^2}} \quad (2)$$

where f_1 is the RMS power of the fundamental (output) frequency and f_2 through f_{10} are the RMS power of the first 9 harmonic frequencies in the output spectrum.

SECOND HARMONIC DISTORTION (2ND HARM) is the difference expressed in dB, between the RMS power in the input frequency at the output and the power in its 2nd harmonic level at the output.

THIRD HARMONIC DISTORTION (3RD HARM) is the difference, expressed in dB, between the RMS power in the input frequency at the output and the power in its 3rd harmonic level at the output.

Timing Diagram

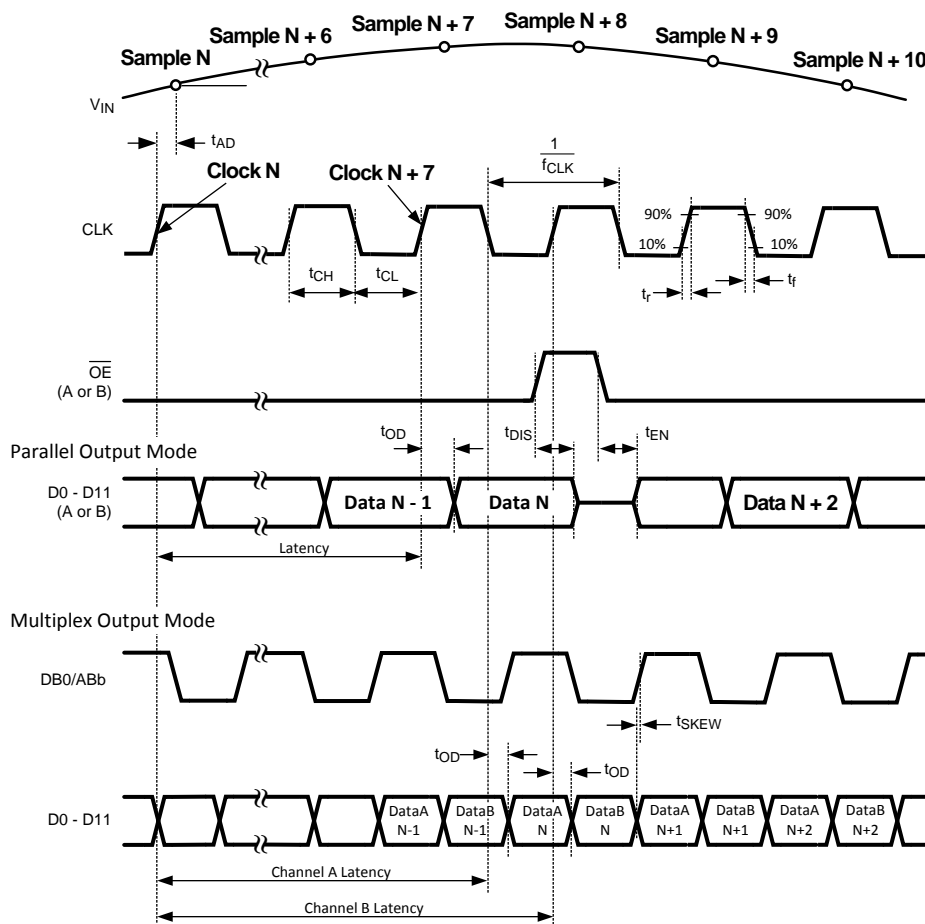

Figure 3. Output Timing

Transfer Characteristic

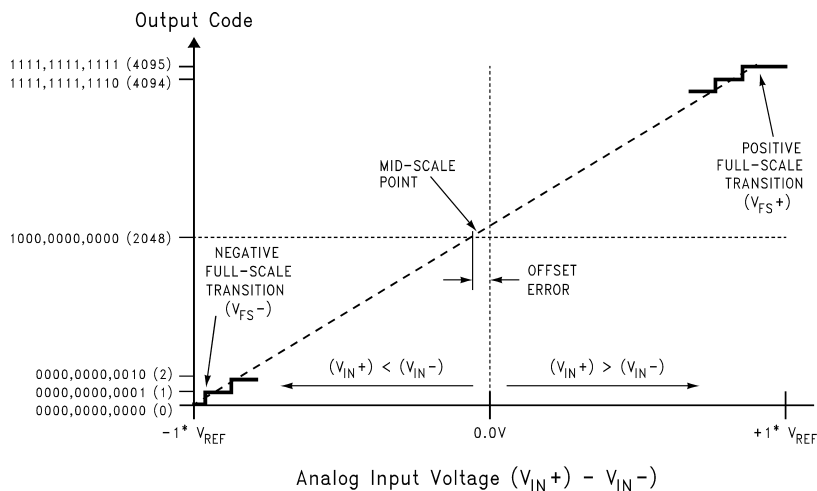

Figure 4. Transfer Characteristic

Typical Performance Characteristics DNL, INL

Unless otherwise specified, the following specifications apply for $AGND = DGND = DR\ GND = 0V$, $V_A = V_D = +3.3V$, $V_{DR} = +2.5V$, $PD = 0V$, $V_{REF} = +1.0V$, $f_{CLK} = 65\text{ MHz}$, $f_{IN} = 0$, $t_r = t_f = 2\text{ ns}$, $C_L = 15\text{ pF/pin}$, Duty Cycle Stabilizer On, parallel output mode. **Boldface limits apply for $T_J = T_{MIN}$ to T_{MAX}** ; all other limits $T_J = 25^\circ\text{C}$

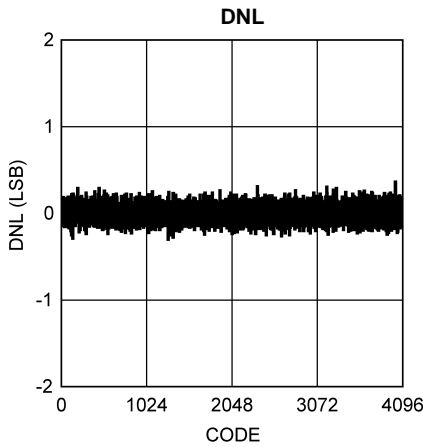

Figure 5.

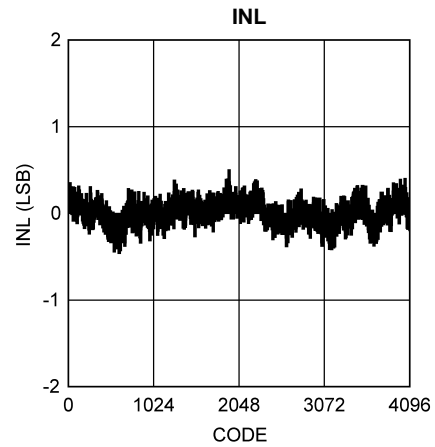

Figure 6.

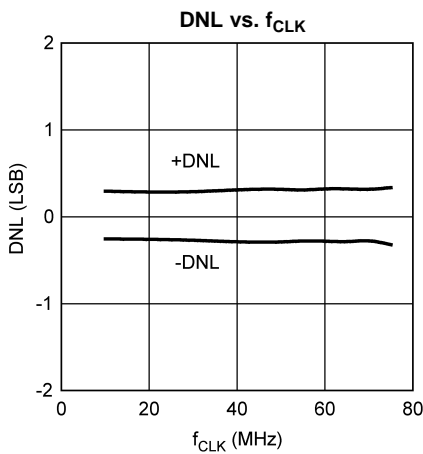

Figure 7.

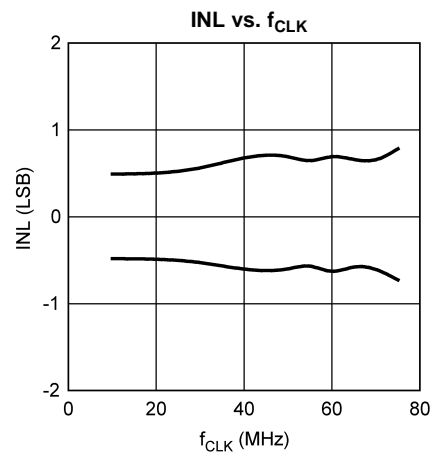

Figure 8.

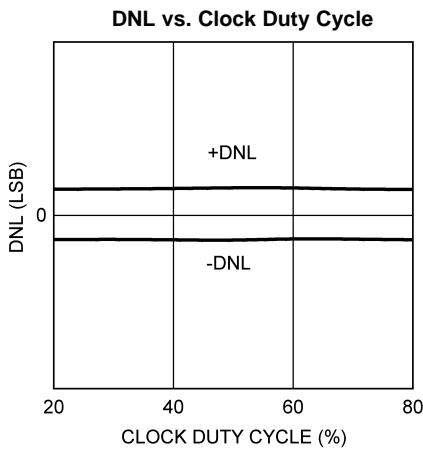

Figure 9.

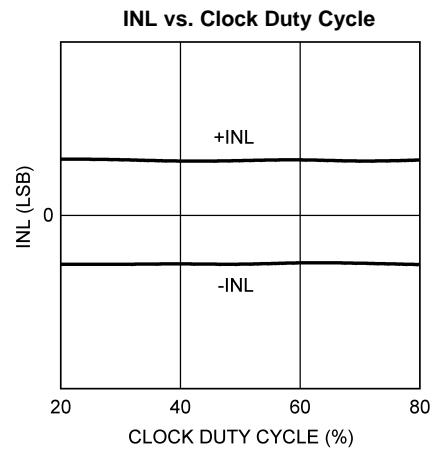

Figure 10.

Typical Performance Characteristics DNL, INL (continued)

Unless otherwise specified, the following specifications apply for AGND = DGND = DR GND = 0V, $V_A = V_D = +3.3V$, $V_{DR} = +2.5V$, PD = 0V, $V_{REF} = +1.0V$, $f_{CLK} = 65$ MHz, $f_{IN} = 0$, $t_r = t_f = 2$ ns, $C_L = 15$ pF/pin, Duty Cycle Stabilizer On, parallel output mode. **Boldface limits apply for $T_J = T_{MIN}$ to T_{MAX}** ; all other limits $T_J = 25^\circ C$

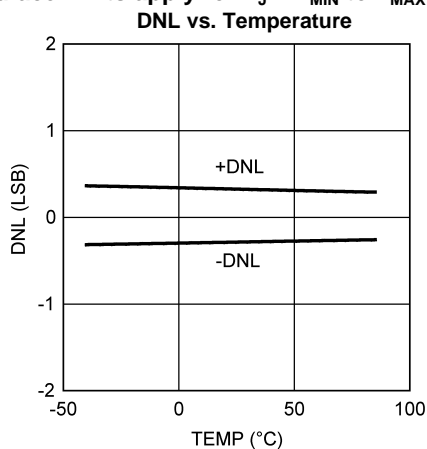

Figure 11.

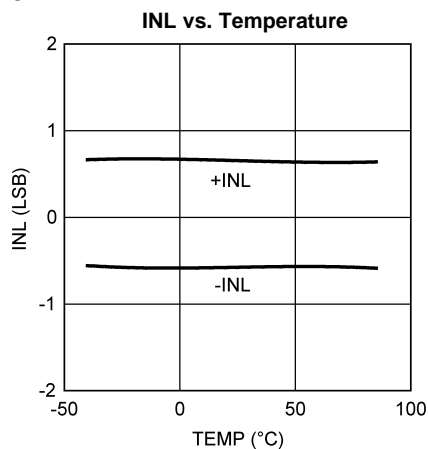

Figure 12.

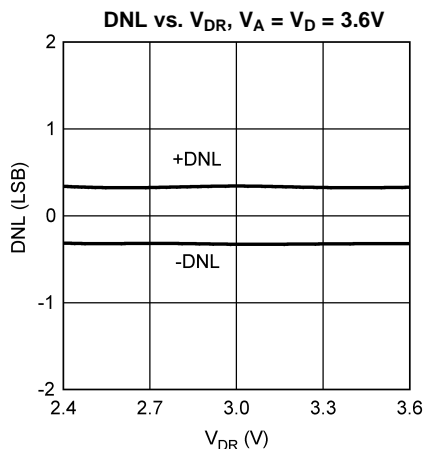

Figure 13.

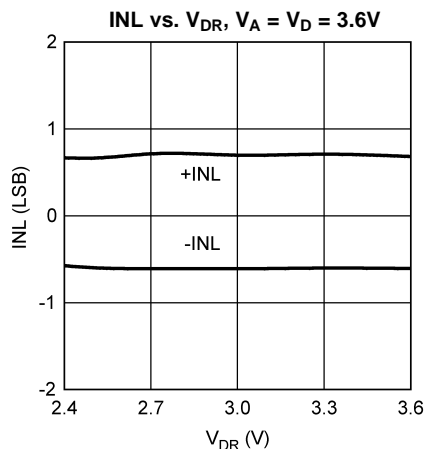

Figure 14.

Typical Performance Characteristics

Unless otherwise specified, the following specifications apply for AGND = DGND = DR GND = 0V, $V_A = V_D = +3.3V$, $V_{DR} = +2.5V$, PD = 0V, $V_{REF} = +1.0V$, $f_{CLK} = 65\text{ MHz}$, $f_{IN} = 32\text{ MHz}$, $t_r = t_f = 2\text{ ns}$, $C_L = 15\text{ pF/pin}$, Duty Cycle Stabilizer On, parallel output mode. **Boldface limits apply for $T_J = T_{MIN}$ to T_{MAX}** ; all other limits $T_J = 25^\circ\text{C}$

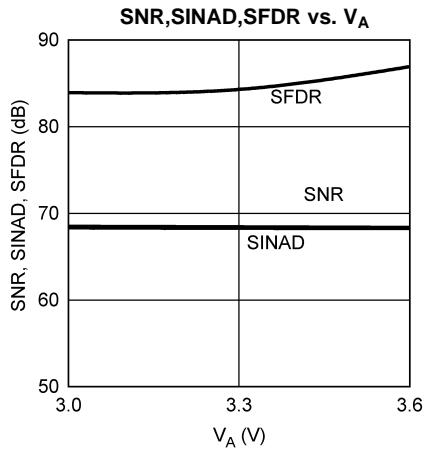

Figure 15.

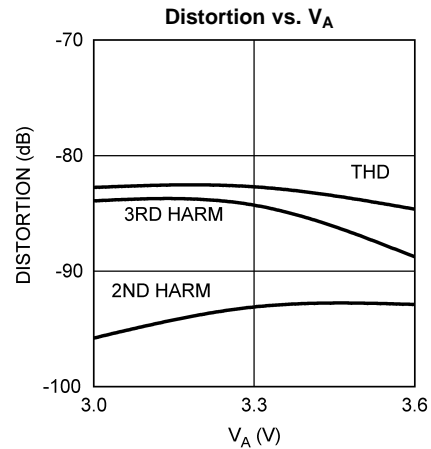

Figure 16.

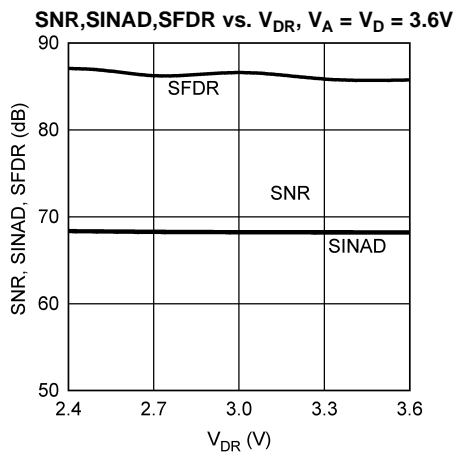

Figure 17.

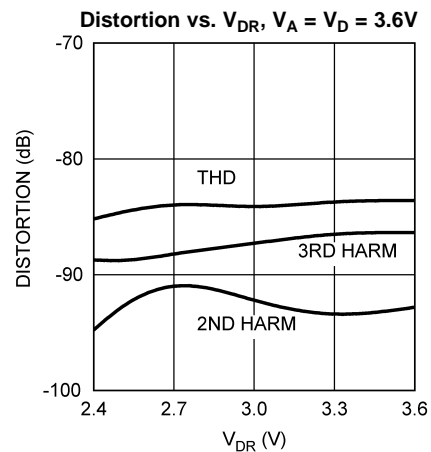

Figure 18.

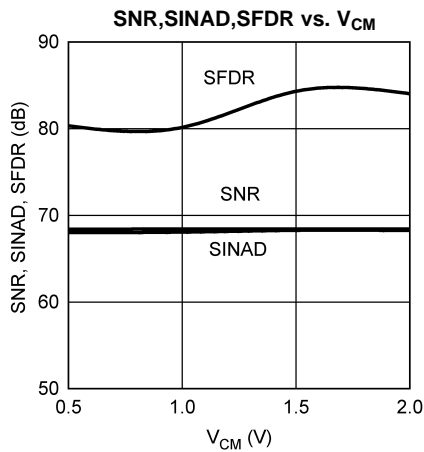

Figure 19.

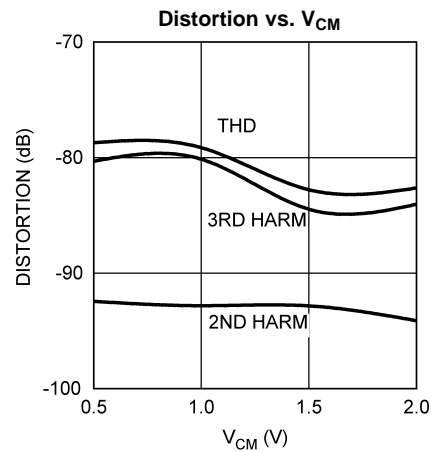

Figure 20.

Typical Performance Characteristics (continued)

Unless otherwise specified, the following specifications apply for AGND = DGND = DR GND = 0V, $V_A = V_D = +3.3V$, $V_{DR} = +2.5V$, PD = 0V, $V_{REF} = +1.0V$, $f_{CLK} = 65\text{ MHz}$, $f_{IN} = 32\text{ MHz}$, $t_r = t_f = 2\text{ ns}$, $C_L = 15\text{ pF/pin}$, Duty Cycle Stabilizer On, parallel output mode. **Boldface limits apply for $T_J = T_{MIN}$ to T_{MAX}** ; all other limits $T_J = 25^\circ\text{C}$

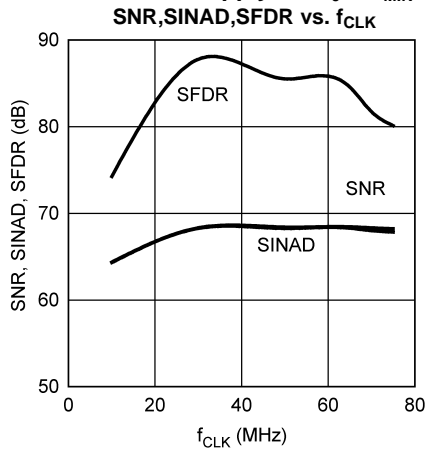

Figure 21.

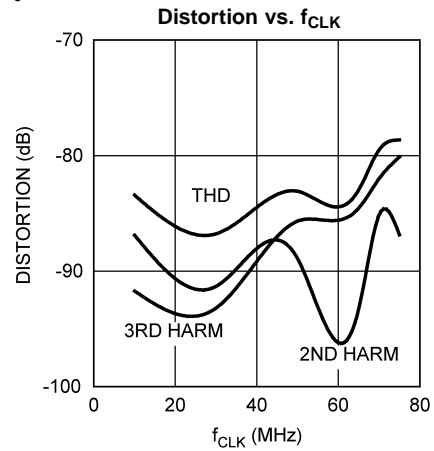

Figure 22.

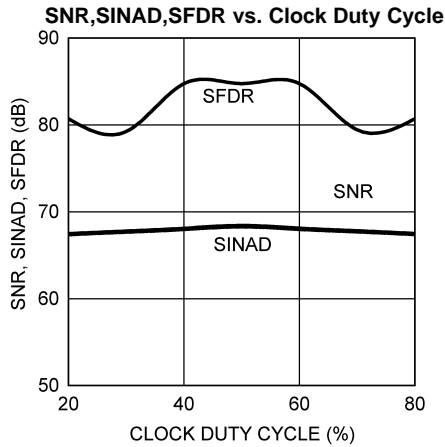

Figure 23.

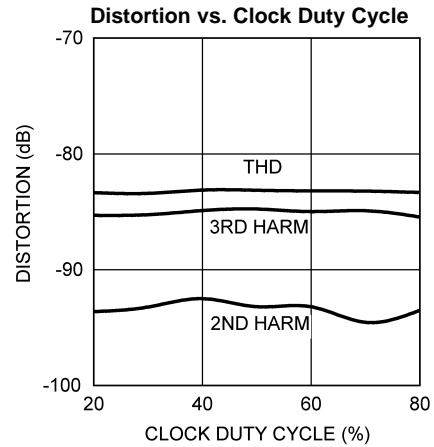

Figure 24.

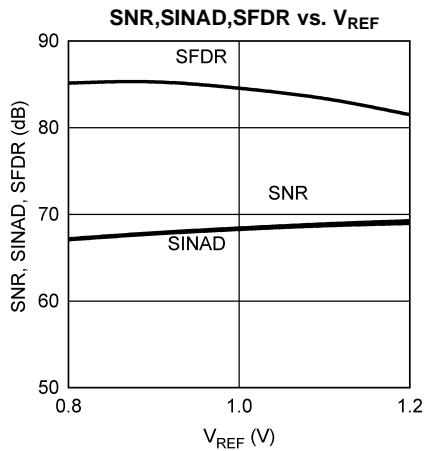

Figure 25.

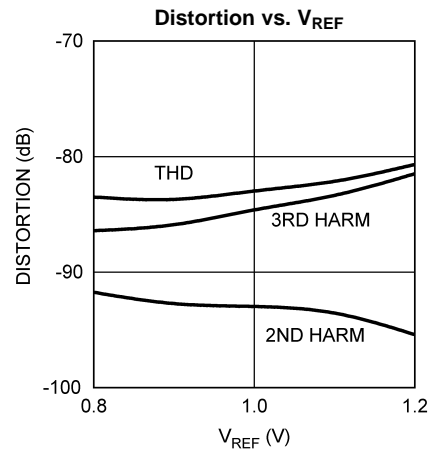

Figure 26.

Typical Performance Characteristics (continued)

Unless otherwise specified, the following specifications apply for AGND = DGND = DR GND = 0V, $V_A = V_D = +3.3V$, $V_{DR} = +2.5V$, PD = 0V, $V_{REF} = +1.0V$, $f_{CLK} = 65\text{ MHz}$, $f_{IN} = 32\text{ MHz}$, $t_r = t_f = 2\text{ ns}$, $C_L = 15\text{ pF/pin}$, Duty Cycle Stabilizer On, parallel output mode. **Boldface limits apply for $T_J = T_{MIN}$ to T_{MAX}** ; all other limits $T_J = 25^\circ\text{C}$

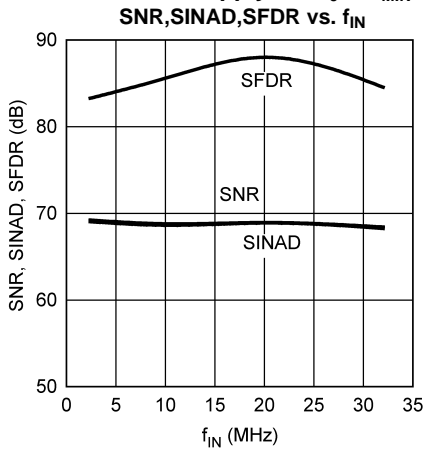

Figure 27.

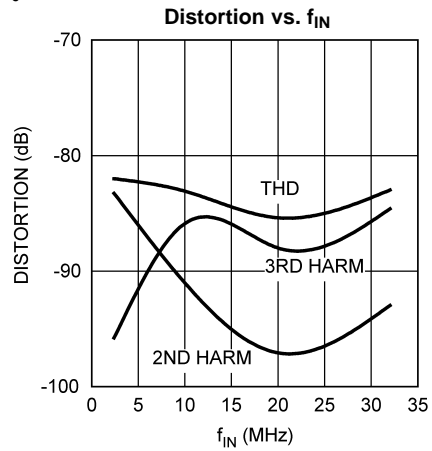

Figure 28.

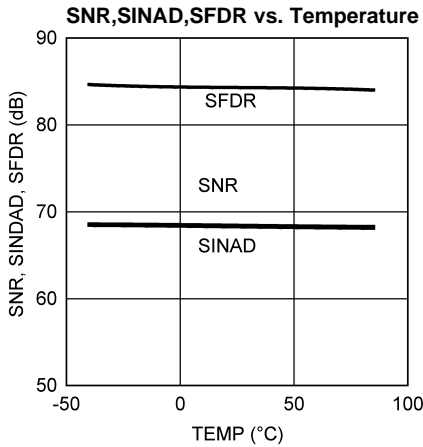

Figure 29.

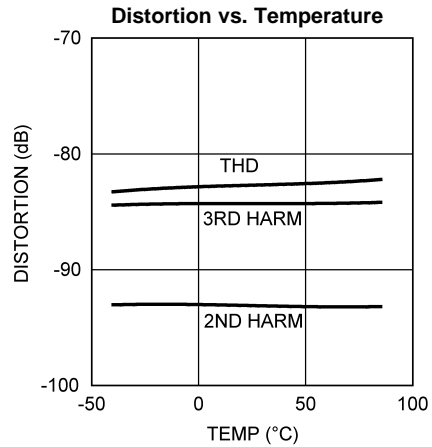

Figure 30.

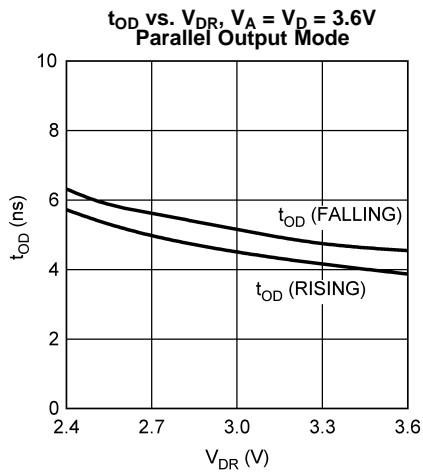

Figure 31.

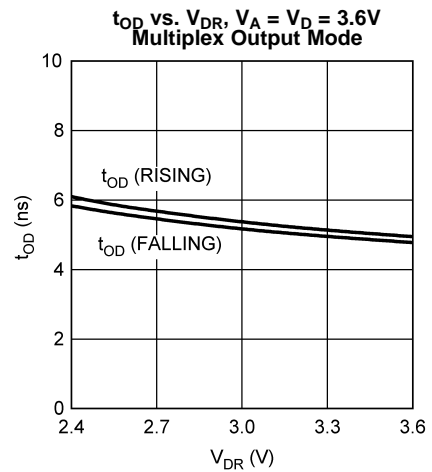

Figure 32.

Typical Performance Characteristics (continued)

Unless otherwise specified, the following specifications apply for AGND = DGND = DR GND = 0V, $V_A = V_D = +3.3V$, $V_{DR} = +2.5V$, PD = 0V, $V_{REF} = +1.0V$, $f_{CLK} = 65\text{ MHz}$, $f_{IN} = 32\text{ MHz}$, $t_r = t_f = 2\text{ ns}$, $C_L = 15\text{ pF/pin}$, Duty Cycle Stabilizer On, parallel output mode. **Boldface limits apply for $T_J = T_{MIN}$ to T_{MAX}** ; all other limits $T_J = 25^\circ\text{C}$

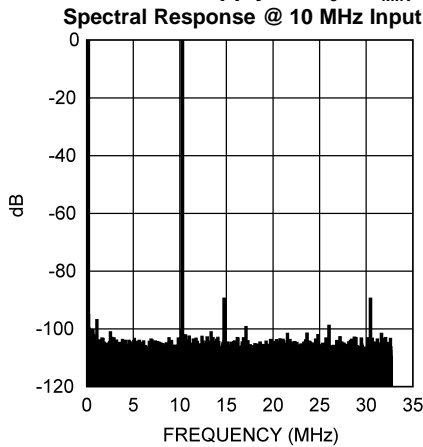

Figure 33.

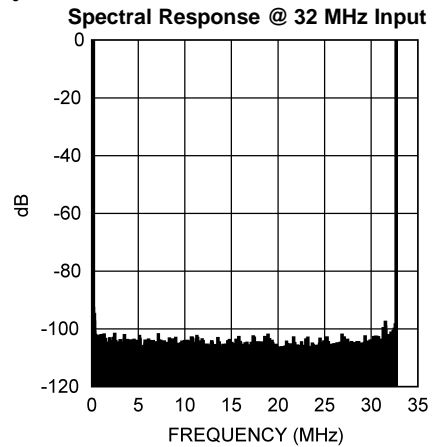

Figure 34.

Intermodulation Distortion, $f_{IN1} = 9.6\text{ MHz}$, $f_{IN2} = 10.2\text{ MHz}$

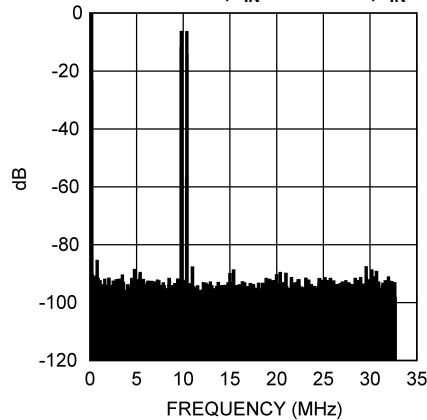

Figure 35.

FUNCTIONAL DESCRIPTION

Operating on a single +3.3V supply, the ADC12DL065 uses a pipeline architecture and has error correction circuitry to help ensure maximum performance. The differential analog input signal is digitized to 12 bits. The user has the choice of using an internal 1.0 Volt or 0.5 Volt stable reference, or using an external reference. Any external reference is buffered on-chip to ease the task of driving that pin.

The output word rate is the same as the clock frequency, which can be between 15 MSPS and 65 MSPS (typical) with fully specified performance at 65 MSPS. The analog input for both channels is acquired at the rising edge of the clock and the digital data for a given sample is delayed by the pipeline for 7 clock cycles. Duty cycle stabilization and output data format are selectable using the quad state function DF/DCS pin. The output data can be set for offset binary or two's complement.

A logic high on the power down (PD) pin reduces the converter power consumption to 36 mW.

Applications Information

OPERATING CONDITIONS

We recommend that the following conditions be observed for operation of the ADC12DL065:

$$3.0V \leq V_A \leq 3.6V$$

$$V_D = V_A$$

$$2.4V \leq V_{DR} \leq V_A$$

$$15 \text{ MHz} \leq f_{CLK} \leq 65 \text{ MHz}$$

$$0.8V \leq V_{REF} \leq 1.2V \text{ (for an external reference)}$$

$$0.5V \leq V_{CM} \leq 2.0V$$

Analog Inputs

There is one reference input pin, V_{REF} , which is used to select an internal reference, or to supply an external reference. The ADC12DL065 has two analog signal input pairs, $V_{IN} A+$ and $V_{IN} A-$ for one converter and $V_{IN} B+$ and $V_{IN} B-$ for the other converter. Each pair of pins forms a differential input pair.

Reference Pins

The ADC12DL065 is designed to operate with an internal 1.0V or 0.5V reference, or an external 1.0V reference, but performs well with reference voltages in the range of 0.8V to 1.2V. Lower reference voltages will decrease the signal-to-noise ratio (SNR) of the ADC12DL065. Increasing the reference voltage (and the input signal swing) beyond 1.2V may degrade THD for a full-scale input, especially at higher input frequencies.

It is important that all grounds associated with the reference voltage and the analog input signal make connection to the ground plane at a single, quiet point to minimize the effects of noise currents in the ground path.

The six Reference Bypass Pins ($V_{RP}A$, $V_{RM}A$, $V_{RN}A$, $V_{RP}B$, $V_{RM}B$ and $V_{RN}B$) are made available for bypass purposes. All these pins should each be bypassed to ground with a 0.1 μ F capacitor. A 10 μ F capacitor should be placed between the $V_{RP}A$ and $V_{RN}A$ pins and between the $V_{RP}B$ and $V_{RN}B$ pins, as shown in [Figure 38](#). This configuration is necessary to avoid reference oscillation, which could result in reduced SFDR and/or SNR.

Smaller capacitor values than those specified will allow faster recovery from the power down mode, but may result in degraded noise performance. Loading any of these pins other than $V_{RM}A$ and $V_{RM}B$ may result in performance degradation.

The nominal voltages for the reference bypass pins are as follows:

$$V_{RM} = 1.5 \text{ V}$$

$$V_{RP} = V_{RM} + V_{REF} / 2$$

$$V_{RN} = V_{RM} - V_{REF} / 2$$

User choice of an on-chip or external reference voltage is provided. The internal 1.0 Volt reference is in use when the V_{REF} pin is connected to V_A . When the V_{REF} pin is connected to AGND, the internal 0.5 Volt reference is in use. If a voltage in the range of 0.8V to 1.2V is applied to the V_{REF} pin, that is used for the voltage reference. When an external reference is used, the V_{REF} pin should be bypassed to ground with a 0.1 μ F capacitor close to the reference input pin. There is no need to bypass the V_{REF} pin when the internal reference is used.

Signal Inputs

The signal inputs are V_{IN+} and V_{IN-} for one ADC and V_{INB+} and V_{INB-} for the other ADC. The input signal, V_{IN} , is defined as

$$V_{IN\ A} = (V_{IN+}) - (V_{IN-}) \quad (3)$$

for the "A" converter and

$$V_{IN\ B} = (V_{INB+}) - (V_{INB-}) \quad (4)$$

for the "B" converter. Figure 36 shows the expected input signal range. Note that the common mode input voltage, V_{CM} , should be in the range of 0.5V to 2.0V.

The peaks of the individual input signals should each never exceed 2.6V.

The ADC12DL065 performs best with a differential input signal with each input centered around a common mode voltage, V_{CM} . The peak-to-peak voltage swing at each analog input pin should not exceed the value of the reference voltage or the output data will be clipped.

The two input signals should be exactly 180° out of phase from each other and of the same amplitude. For single frequency inputs, angular errors result in a reduction of the effective full scale input. For complex waveforms, however, angular errors will result in distortion.

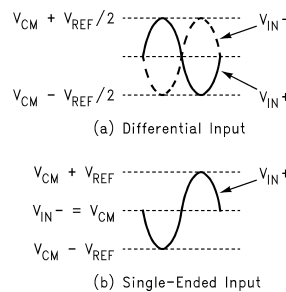

Figure 36. Expected Input Signal Range

For single frequency sine waves the full scale error in LSB can be described as approximately

$$E_{FS} = 4096 (1 - \sin(90^\circ + dev)) \quad (5)$$

Where dev is the angular difference in degrees between the two signals having a 180° relative phase relationship to each other (see Figure 37). Drive the analog inputs with a source impedance less than 100Ω.

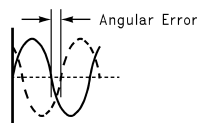

Figure 37. Angular Errors Between the Two Input Signals Will Reduce the Output Level or Cause Distortion

For differential operation, each analog input pin of the differential pair should have a peak-to-peak voltage equal to the reference voltage, V_{REF} , be 180 degrees out of phase with each other and be centered around V_{CM} .

Single-Ended Operation

Performance with differential input signals is better than with single-ended signals. For this reason, single-ended operation is not recommended. However, if single ended-operation is required and the resulting performance degradation is acceptable, one of the analog inputs should be connected to the d.c. mid point voltage of the driven input. The peak-to-peak differential input signal at the driven input pin should be twice the reference voltage to maximize SNR and SINAD performance (Figure 36b). For example, set V_{REF} to 0.5V, bias V_{IN-} to 1.0V and drive V_{IN+} with a signal range of 0.5V to 1.5V.

Because very large input signal swings can degrade distortion performance, better performance with a single-ended input can be obtained by reducing the reference voltage when maintaining a full-range output. Table 1 and Table 2 indicate the input to output relationship of the ADC12DL065.

Table 1. Input to Output Relationship – Differential Input

V_{IN}^+	V_{IN}^-	Binary Output	2's Complement Output
$V_{CM} - V_{REF}/2$	$V_{CM} + V_{REF}/2$	0000 0000 0000	1000 0000 0000
$V_{CM} - V_{REF}/4$	$V_{CM} + V_{REF}/4$	0100 0000 0000	1100 0000 0000
V_{CM}	V_{CM}	1000 0000 0000	0000 0000 0000
$V_{CM} + V_{REF}/4$	$V_{CM} - V_{REF}/4$	1100 0000 0000	0100 0000 0000
$V_{CM} + V_{REF}/2$	$V_{CM} - V_{REF}/2$	1111 1111 1111	0111 1111 1111

Table 2. Input to Output Relationship – Single-Ended Input

V_{IN}^+	V_{IN}^-	Binary Output	2's Complement Output
$V_{CM} - V_{REF}$	V_{CM}	0000 0000 0000	1000 0000 0000
$V_{CM} - V_{REF}/2$	V_{CM}	0100 0000 0000	1100 0000 0000
V_{CM}	V_{CM}	1000 0000 0000	0000 0000 0000
$V_{CM} + V_{REF}/2$	V_{CM}	1100 0000 0000	0100 0000 0000
$V_{CM} + V_{REF}$	V_{CM}	1111 1111 1111	0111 1111 1111

Driving the Analog Inputs

The V_{IN}^+ and the V_{IN}^- inputs of the ADC12DL065 consist of an analog switch followed by a switched-capacitor amplifier. The capacitance seen at the analog input pins changes with the clock level, appearing as 8 pF when the clock is low, and 7 pF when the clock is high.

As the internal sampling switch opens and closes, current pulses occur at the analog input pins, resulting in voltage spikes at the signal input pins. As a driving amplifier attempts to counteract these voltage spikes, a damped oscillation may appear at the ADC analog input. Do not attempt to filter out these pulses. Rather, use amplifiers to drive the ADC12DL065 input pins that are able to react to these pulses and settle before the switch opens and another sample is taken. The LMH6702, LMH6628, LMH6622 and the LMH6655 are good amplifiers for driving the ADC12DL065.

To help isolate the pulses at the ADC input from the amplifier output, use RCs at the inputs, as can be seen in [Figure 38](#) through [Figure 40](#). These components should be placed close to the ADC inputs because the input pins of the ADC is the most sensitive part of the system and this is the last opportunity to filter that input.

For Nyquist applications the RC pole should be at the ADC sample rate. The ADC input capacitance in the sample mode should be considered when setting the RC pole. For wideband undersampling applications, the RC pole should be set at about 1.5 to 2 times the maximum input frequency to maintain a linear delay response.

A single-ended to differential conversion circuit is shown in [Figure 40](#). [Table 3](#) gives resistor values for that circuit to provide input signals in a range of $1.0V \pm 0.5V$ at each of the differential input pins of the ADC12DL065.

Table 3. Resistor Values for Circuit of [Figure 40](#)

SIGNAL RANGE	R1	R2	R3	R4	R5, R6
0 - 0.25V	open	0 Ω	124 Ω	1500 Ω	1000 Ω
0 - 0.5V	0 Ω	open Ω	499 Ω	1500 Ω	499 Ω
$\pm 0.25V$	100 Ω	698 Ω	100 Ω	698 Ω	499 Ω

Input Common Mode Voltage

The input common mode voltage, V_{CM} , should be in the range of 0.5V to 2.0V and be a value such that the peak excursions of the analog signal does not go more negative than ground or more positive than 2.6V. See [Reference Pins](#).

DIGITAL INPUTS

Digital TTL/CMOS compatible inputs consist of CLK, \overline{OEA} , \overline{OEB} , PD, DF/DCS, and MULTIPLEX.

CLK

The **CLK** signal controls the timing of the sampling process. Drive the clock input with a stable, low jitter clock signal in the range of 15 MHz to 65 MHz with rise and fall times of 2 ns or less. The trace carrying the clock signal should be as short as possible and should not cross any other signal line, analog or digital, not even at 90°.

The **CLK** signal also drives an internal state machine. If the **CLK** is interrupted, or its frequency too low, the charge on internal capacitors can dissipate to the point where the accuracy of the output data will degrade. This is what limits the lowest sample rate.

The clock line should be terminated at its source in the characteristic impedance of that line. Take care to maintain a constant clock line impedance throughout the length of the line. Refer to Application Note AN-905 ([SNLA035](#)) for information on setting characteristic impedance.

It is highly desirable that the the source driving the ADC **CLK** pin only drive that pin. However, if that source is used to drive other things, each driven pin should be a.c. terminated with a series RC to ground, as shown in [Figure 38](#), such that the resistor value is equal to the characteristic impedance of the clock line and the capacitor value is

$$C \geq \frac{4 \times t_{PD} \times L}{Z_0} \quad (6)$$

where t_{PD} is the signal propagation rate down the clock line, "L" is the line length and Z_0 is the characteristic impedance of the clock line. This termination should be as close as possible to the ADC clock pin but beyond it as seen from the clock source. Typical t_{PD} is about 150 ps/inch (60 ps/cm) on FR-4 board material. The units of "L" and t_{PD} should be the same (inches or centimeters).

The duty cycle of the clock signal can affect the performance of the A/D Converter. Because achieving a precise duty cycle is difficult, the ADC12DL065 has a Duty Cycle Stabilizer which can be enabled using the DF/DCS pin. It is designed to maintain performance over a clock duty cycle range of 20% to 80% at 65 MSPS. The Duty Cycle Stabilizer circuit requires a fast clock edge to produce the internal clock, which is the reason for the rise and fall time requirement listed in the specifications table.

\overline{OEA} , \overline{OEB}

The \overline{OEA} and \overline{OEB} pins, when high, put the output pins of their respective converters into a high impedance state. When either of these pin is low, the corresponding outputs are in the active state. The ADC12DL065 will continue to convert whether these pins are high or low, but the output can not be read while the pin is high.

Since ADC noise increases with increased output capacitance at the digital output pins, do not use the TRI-STATE outputs of the ADC12DL065 to drive a bus. Rather, each output pin should be located close to and drive a single digital input pin. To further reduce ADC noise, a 100 Ω resistor in series with each ADC digital output pin, located close to their respective pins, should be added to the circuit.

PD

The PD pin, when high, holds the ADC12DL065 in a power-down mode to conserve power when the converter is not being used. The power consumption in this state is 36 mW with a 65MHz clock and 40mW if the clock is stopped when PD is high. The output data pins are undefined and the data in the pipeline is corrupted while in the power down mode.

The Power Down Mode Exit Cycle time is determined by the value of the components on pins 4, 5, 6, 12, 13 and 14 and is about 500 μ s with the recommended components on the V_{RP} , V_{RM} and V_{RN} reference bypass pins. These capacitors loose their charge in the Power Down mode and must be recharged by on-chip circuitry before conversions can be accurate. Smaller capacitor values allow slightly faster recovery from the power down mode, but can result in a reduction in SNR, SINAD and ENOB performance.

DF/DCS

Duty cycle stabilization and output data format are selectable using this quad state function pin. When enabled, duty cycle stabilization can compensate for clock inputs with duty cycles ranging from 20% to 80% and generate a stable internal clock, improving the performance of the part. The Duty Cycle Stabilizer circuit requires a fast clock edge to produce the internal clock, which is the reason for the rise and fall time requirement listed in the specifications table. With $DF/DCS = V_A$ the output data format is offset binary and duty cycle stabilization is applied to the clock. With $DF/DCS = 0$ the output data format is 2's complement and duty cycle stabilization is applied to the clock. With $DF/DCS = V_{RMA}$ or V_{RMB} the output data format is 2's complement and duty cycle stabilization is not used. If DF/DCS is floating, the output data format is offset binary and duty cycle stabilization is not used. While the sense of this pin may be changed "on the fly," doing this is not recommended as the output data could be erroneous for a few clock cycles after this change is made.

MULTIPLEX

With the MULTIPLEX pin at a logic low, the digital output words from channels A and B are available on separate digital output buses (Parallel mode). When MULTIPLEX is high, the digital output words are multiplexed on pins DA0:DA11 (Multiplex Mode). The DB0/ABb pin changes synchronously with the multiplexed outputs, and is high when channel A data is present on the outputs, and low when channel B data is present.

OUTPUTS

The ADC12DL065 has 12 TTL/CMOS compatible Data Output pins for each output. Valid data is present at these outputs while the OE and PD pins are low. In the parallel mode, the data should be captured with the CLK signal. Depending on the setup and hold time requirements of the receiving circuit (ASIC), either the rising edge or the falling edge of the CLK signal can be used to latch the data. Generally, rising-edge-capture would maximize setup time with minimal hold time; while falling-edge-capture would maximize hold time with minimal setup time. However, actual timing for the falling-edge case depends greatly on the CLK frequency and both cases also depend on the delays inside the ASIC. Refer to the Tod spec in [AC Electrical Characteristics](#).

In Multiplex mode, both channel outputs are available on DA0:DA11. The ABb signal is available to de-multiplex the output bus. The ABb signal may also be used to latch the data in the ASIC thus avoiding the use of the CLK signal altogether. However, since the ABb signal edges are provided in-phase with the data transitions, generally the ASIC circuitry would have to delay the ABb signal with respect to the data in order to use it as the clock for the capturing latches. It is also possible to use the CLK signal to latch the data in the multiplexed mode as well - as described in the previous paragraph.

Be very careful when driving a high capacitance bus. The more capacitance the output drivers must charge for each conversion, the more instantaneous digital current flows through V_{DR} and DR GND. These large charging current spikes can cause on-chip ground noise and couple into the analog circuitry, degrading dynamic performance. Adequate bypassing, limiting output capacitance and careful attention to the ground plane will reduce this problem. Additionally, bus capacitance beyond the specified 15 pF/pin will cause t_{OD} to increase, making it difficult to properly latch the ADC output data. The result could be an apparent reduction in dynamic performance.

To minimize noise due to output switching, minimize the load currents at the digital outputs. This can be done by connecting buffers (74ACQ541, for example) between the ADC outputs and any other circuitry. Only one driven input should be connected to each output pin. Additionally, inserting series resistors of about 100Ω at the digital outputs, close to the ADC pins, will isolate the outputs from trace and other circuit capacitances and limit the output currents, which could otherwise result in performance degradation. See [Figure 38](#).

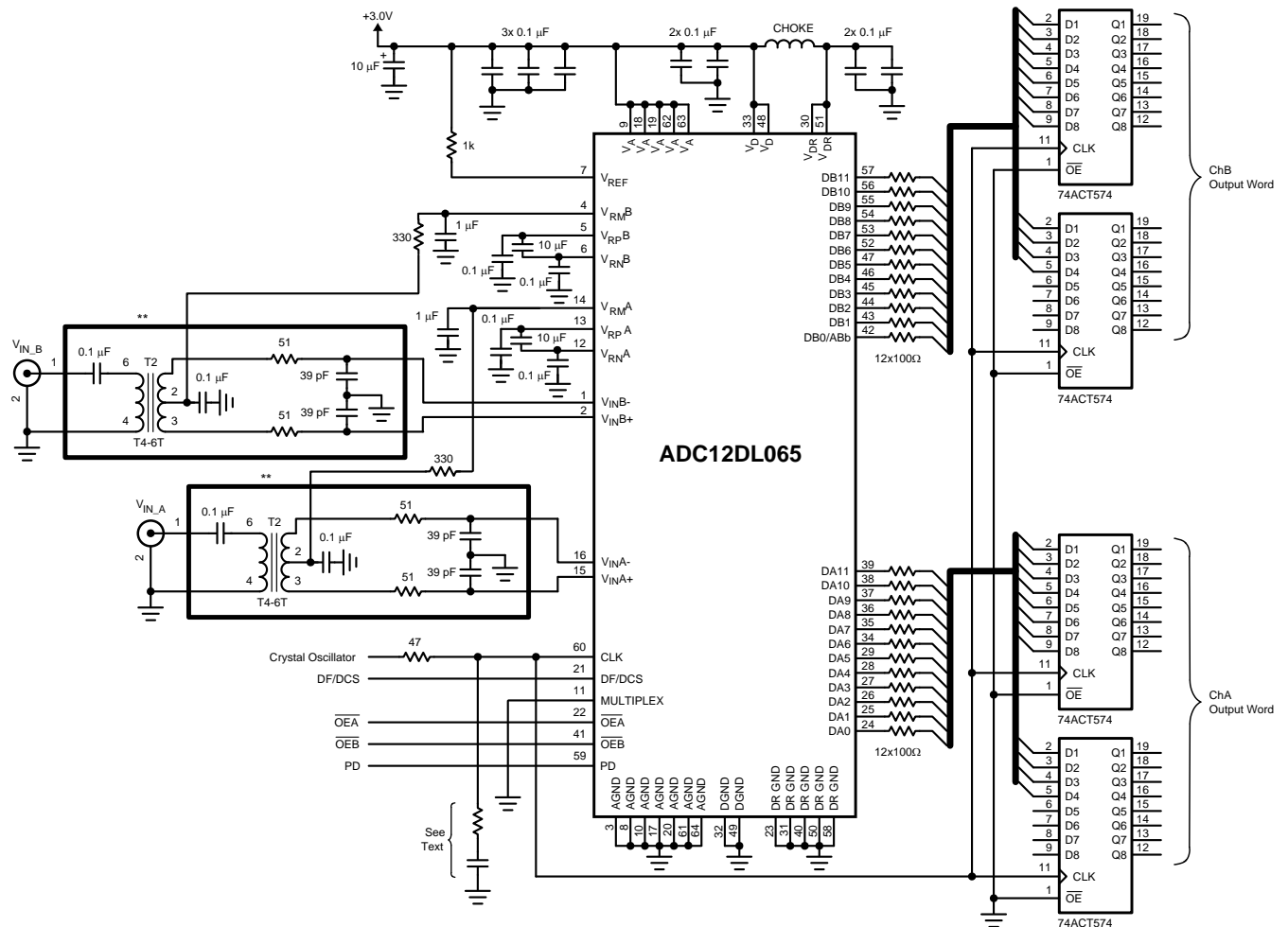

A. ** – May be replaced by Ckt in Figure 40.

Figure 38. Application Circuit using Transformer or Differential Op-Amp Drive Circuit, Parallel mode

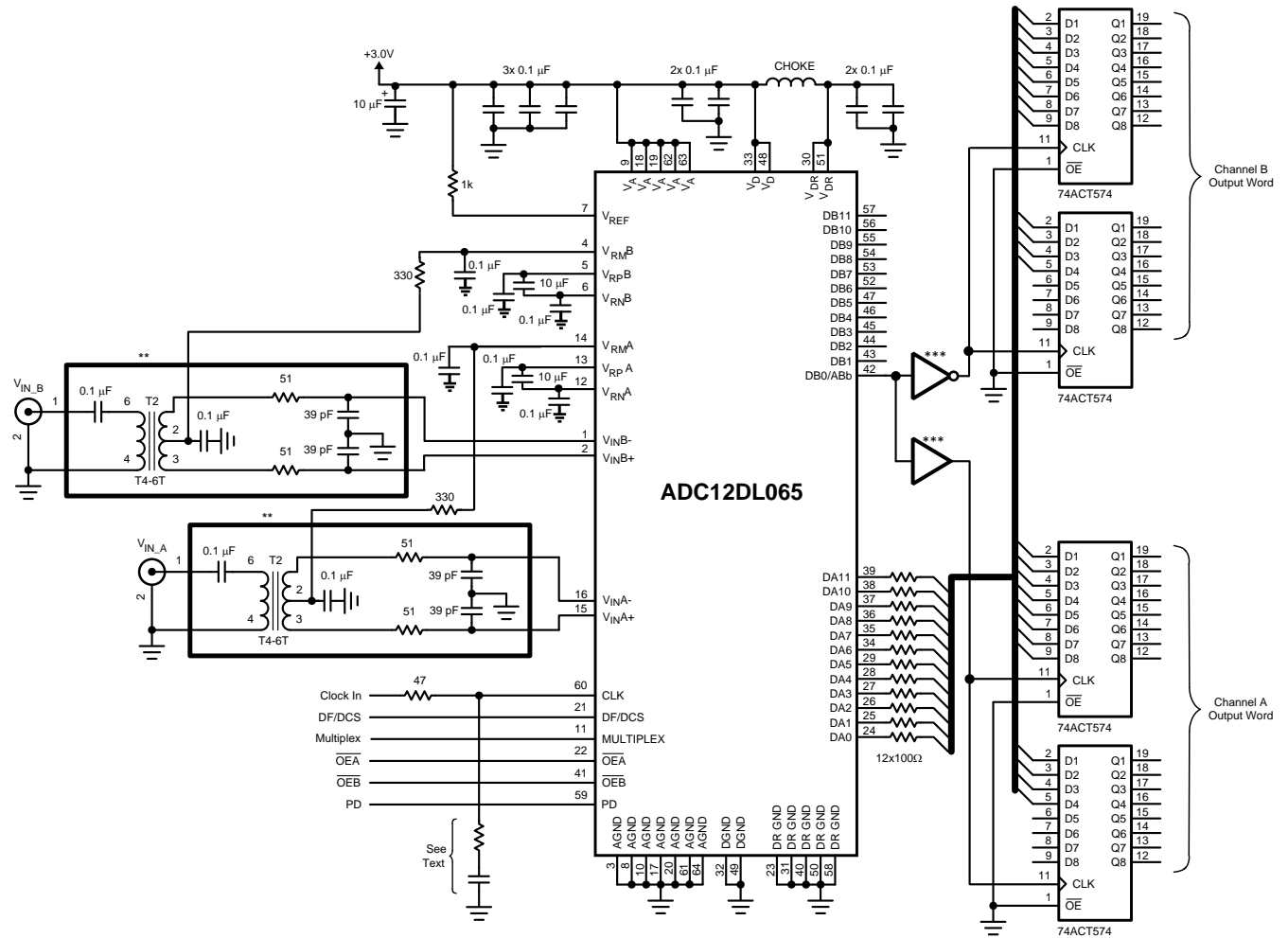

- A. ** – May be replaced by Ckt in [Figure 40](#).
- B. *** – The delay through the inverters should be adjusted to allow the correct setup and hold time for the latches.

Figure 39. Application Circuit using Transformer or Differential Op-Amp Drive Circuit, Multiplex mode

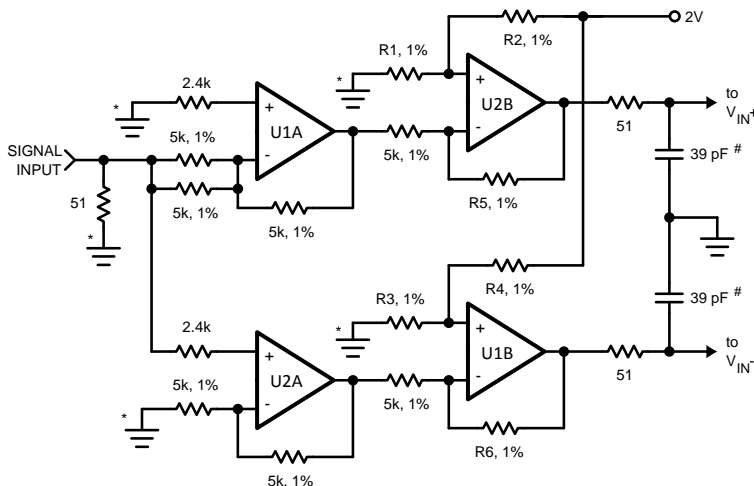

- A. Amplifiers: two LMH6622s or LMH6655s
- B. * – The ground connections indicated with an "*" should be connected to a common point in the analog ground plane.
- C. # – The 39 pF capacitors between the two inputs are for Nyquist applications and should be removed for undersampling applications.

Figure 40. Differential Drive Circuit of Figure 38

POWER SUPPLY CONSIDERATIONS

The power supply pins should be bypassed with a 10 μ F capacitor and with a 0.1 μ F ceramic chip capacitor within a centimeter of each power pin. Leadless chip capacitors are preferred because they have low series inductance.

As is the case with all high-speed converters, the ADC12DL065 is sensitive to power supply noise. Accordingly, the noise on the analog supply pin should be kept below 100 mV_{P-P}.

No pin should ever have a voltage on it that is in excess of the supply voltages, not even on a transient basis. Be especially careful of this during power turn on and turn off.

The V_{DR} pin provides power for the output drivers and may be operated from a supply in the range of 2.4V to V_D . This can simplify interfacing to lower voltage devices and systems. Note, however, that t_{OD} increases with reduced V_{DR} . **DO NOT operate the V_{DR} pin at a voltage higher than V_D .**

LAYOUT AND GROUNDING

Proper grounding and proper routing of all signals are essential to ensure accurate conversion. Maintaining separate analog and digital areas of the board, with the ADC12DL065 between these areas, is required to achieve specified performance.

The ground return for the data outputs (DR GND) carries the ground current for the output drivers. The output current can exhibit high transients that could add noise to the conversion process. To prevent this from happening, the DR GND pins should NOT be connected to system ground in close proximity to any of the ADC12DL065's other ground pins.

Capacitive coupling between the typically noisy digital circuitry and the sensitive analog circuitry can lead to poor performance. The solution is to keep the analog circuitry separated from the digital circuitry, and to keep the clock line as short as possible.

Digital circuits create substantial supply and ground current transients. The logic noise thus generated could have significant impact upon system noise performance. The best logic family to use in systems with A/D converters is one which employs non-saturating transistor designs, or has low noise characteristics, such as the 74LS, 74HC(T) and 74AC(T)Q families. The worst noise generators are logic families that draw the largest supply current transients during clock or signal edges, like the 74F and the 74AC(T) families.

The effects of the noise generated from the ADC output switching can be minimized through the use of 100 Ω resistors in series with each data output line. Locate these resistors as close to the ADC output pins as possible.

Since digital switching transients are composed largely of high frequency components, total ground plane copper weight will have little effect upon the logic-generated noise. This is because of the skin effect. Total surface area is more important than is total ground plane volume.

Generally, analog and digital lines should cross each other at 90° to avoid crosstalk. To maximize accuracy in high speed, high resolution systems, however, avoid crossing analog and digital lines altogether. It is important to keep clock lines as short as possible and isolated from ALL other lines, including other digital lines. Even the generally accepted 90° crossing should be avoided with the clock line as even a little coupling can cause problems at high frequencies. This is because other lines can introduce jitter into the clock line, which can lead to degradation of SNR. Also, the high speed clock can introduce noise into the analog chain.

Best performance at high frequencies and at high resolution is obtained with a straight signal path. That is, the signal path through all components should form a straight line wherever possible.

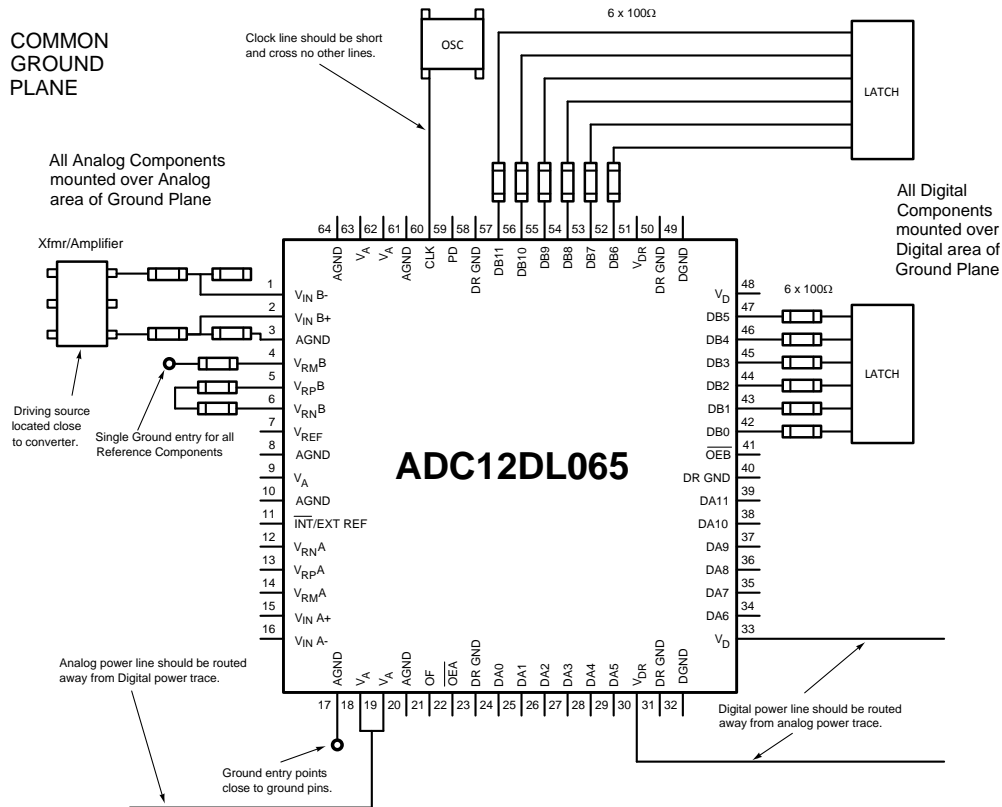

Figure 41. Example of a Suitable Layout

Be especially careful with the layout of inductors. Mutual inductance can change the characteristics of the circuit in which they are used. Inductors should *not* be placed side by side, even with just a small part of their bodies beside each other.

The analog input should be isolated from noisy signal traces to avoid coupling of spurious signals into the input. Any external component (e.g., a filter capacitor) connected between the converter's input pins and ground or to the reference input pin and ground should be connected to a very clean point in the ground plane.

Figure 41 gives an example of a suitable layout. All analog circuitry (input amplifiers, filters, reference components, etc.) should be placed in the analog area of the board. All digital circuitry and I/O lines should be placed in the digital area of the board. The ADC12DL065 should be between these two areas. Furthermore, all components in the reference circuitry and the input signal chain that are connected to ground should be connected together with short traces and enter the ground plane at a single, quiet point. All ground connections should have a low inductance path to ground.

DYNAMIC PERFORMANCE

To achieve the best dynamic performance, the clock source driving the CLK input must be free of jitter. Isolate the ADC clock from any digital circuitry with buffers, as with the clock tree shown in Figure 42. The gates used in the clock tree must be capable of operating at frequencies much higher than those used if added jitter is to be prevented.

Best performance will be obtained with a differential input drive, compared with a single-ended drive, as discussed in [Single-Ended Operation](#) and [Driving the Analog Inputs](#).

As mentioned in [LAYOUT AND GROUNDING](#), it is good practice to keep the ADC clock line as short as possible and to keep it well away from any other signals. Other signals can introduce jitter into the clock signal, which can lead to reduced SNR performance, and the clock can introduce noise into other lines. Even lines with 90° crossings have capacitive coupling, so try to avoid even these 90° crossings of the clock line.

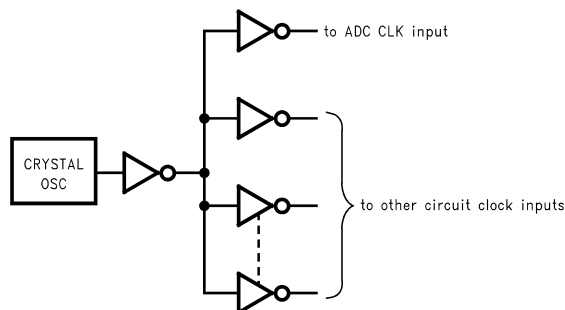

Figure 42. Isolating the ADC Clock from other Circuitry with a Clock Tree

COMMON APPLICATION PITFALLS

Driving the inputs (analog or digital) beyond the power supply rails. For proper operation, all inputs should not go more than 100 mV beyond the supply rails (more than 100 mV below the ground pins or 100 mV above the supply pins). Exceeding these limits on even a transient basis may cause faulty or erratic operation. It is not uncommon for high speed digital components (e.g., 74F and 74AC devices) to exhibit overshoot or undershoot that goes above the power supply or below ground. A resistor of about 47Ω to 100Ω in series with any offending digital input, close to the signal source, will eliminate the problem.

Do not allow input voltages to exceed the supply voltage, even on a transient basis. Not even during power up or power down.

Be careful not to overdrive the inputs of the ADC12DL065 with a device that is powered from supplies outside the range of the ADC12DL065 supply. Such practice may lead to conversion inaccuracies and even to device damage.

Attempting to drive a high capacitance digital data bus. The more capacitance the output drivers must charge for each conversion, the more instantaneous digital current flows through V_{DR} and DR GND. These large charging current spikes can couple into the analog circuitry, degrading dynamic performance. Adequate bypassing and maintaining separate analog and digital areas on the pc board will reduce this problem.

Additionally, bus capacitance beyond the specified 15 pF/pin will cause t_{OD} to increase, making it difficult to properly latch the ADC output data. The result could, again, be an apparent reduction in dynamic performance.

The digital data outputs should be buffered (with 74ACQ541, for example). Dynamic performance can also be improved by adding series resistors at each digital output, close to the ADC12DL065, which reduces the energy coupled back into the converter output pins by limiting the output current. A reasonable value for these resistors is 100Ω.

Using an inadequate amplifier to drive the analog input. As explained in [Signal Inputs](#), the capacitance seen at the input alternates between 8 pF and 7 pF, depending upon the phase of the clock. This dynamic load is more difficult to drive than is a fixed capacitance.

If the amplifier exhibits overshoot, ringing, or any evidence of instability, even at a very low level, it will degrade performance. A small series resistor at each amplifier output and a capacitor at the analog inputs (as shown in [Figure 39](#) and [Figure 40](#)) will improve performance. The LMH6702 and the LMH6628 have been successfully used to drive the analog inputs of the ADC12DL065.

Also, it is important that the signals at the two inputs have exactly the same amplitude and be exactly 180° out of phase with each other. Board layout, especially equality of the length of the two traces to the input pins, will affect the effective phase between these two signals. Remember that an operational amplifier operated in the non-inverting configuration will exhibit more time delay than will the same device operating in the inverting configuration.

Operating with the reference pins outside of the specified range. As mentioned in [Reference Pins](#), V_{REF} should be in the range of

$$0.8V \leq V_{REF} \leq 1.2V \quad (7)$$

Operating outside of these limits could lead to performance degradation.

Inadequate network on Reference Bypass pins ($V_{RP}A$, $V_{RN}A$, $V_{RM}A$, $V_{RP}B$, $V_{RN}B$ and $V_{RM}B$). As mentioned in [Reference Pins](#), these pins should be bypassed with 0.1 μ F capacitors to ground at $V_{RM}A$ and $V_{RM}B$ and with a series RC of 1.5 Ω and 1.0 μ F between pins $V_{RP}A$ and $V_{RN}A$ and between $V_{RP}B$ and $V_{RN}B$ for best performance.

Using a clock source with excessive jitter, using excessively long clock signal trace, or having other signals coupled to the clock signal trace. This will cause the sampling interval to vary, causing excessive output noise and a reduction in SNR and SINAD performance.

REVISION HISTORY

Changes from Revision C (April 2013) to Revision D	Page
<hr/> <ul style="list-style-type: none">• Changed layout of National Data Sheet to TI format	<hr/> 30

PACKAGING INFORMATION

Orderable Device	Status (1)	Package Type	Package Drawing	Pins	Package Qty	Eco Plan (2)	Lead finish/ Ball material (6)	MSL Peak Temp (3)	Op Temp (°C)	Device Marking (4/5)	Samples
ADC12DL065CIVS/NOPB	ACTIVE	TQFP	PAG	64	160	RoHS & Green	SN	Level-3-260C-168 HR	-40 to 85	ADC12DL065 CIVS	Samples

(1) The marketing status values are defined as follows:

ACTIVE: Product device recommended for new designs.

LIFEBUY: TI has announced that the device will be discontinued, and a lifetime-buy period is in effect.

NRND: Not recommended for new designs. Device is in production to support existing customers, but TI does not recommend using this part in a new design.

PREVIEW: Device has been announced but is not in production. Samples may or may not be available.

OBSOLETE: TI has discontinued the production of the device.

(2) **RoHS:** TI defines "RoHS" to mean semiconductor products that are compliant with the current EU RoHS requirements for all 10 RoHS substances, including the requirement that RoHS substance do not exceed 0.1% by weight in homogeneous materials. Where designed to be soldered at high temperatures, "RoHS" products are suitable for use in specified lead-free processes. TI may reference these types of products as "Pb-Free".

RoHS Exempt: TI defines "RoHS Exempt" to mean products that contain lead but are compliant with EU RoHS pursuant to a specific EU RoHS exemption.

Green: TI defines "Green" to mean the content of Chlorine (Cl) and Bromine (Br) based flame retardants meet JS709B low halogen requirements of <=100ppm threshold. Antimony trioxide based flame retardants must also meet the <=1000ppm threshold requirement.

(3) MSL, Peak Temp. - The Moisture Sensitivity Level rating according to the JEDEC industry standard classifications, and peak solder temperature.

(4) There may be additional marking, which relates to the logo, the lot trace code information, or the environmental category on the device.

(5) Multiple Device Markings will be inside parentheses. Only one Device Marking contained in parentheses and separated by a "~" will appear on a device. If a line is indented then it is a continuation of the previous line and the two combined represent the entire Device Marking for that device.

(6) Lead finish/Ball material - Orderable Devices may have multiple material finish options. Finish options are separated by a vertical ruled line. Lead finish/Ball material values may wrap to two lines if the finish value exceeds the maximum column width.

Important Information and Disclaimer:The information provided on this page represents TI's knowledge and belief as of the date that it is provided. TI bases its knowledge and belief on information provided by third parties, and makes no representation or warranty as to the accuracy of such information. Efforts are underway to better integrate information from third parties. TI has taken and continues to take reasonable steps to provide representative and accurate information but may not have conducted destructive testing or chemical analysis on incoming materials and chemicals. TI and TI suppliers consider certain information to be proprietary, and thus CAS numbers and other limited information may not be available for release.

In no event shall TI's liability arising out of such information exceed the total purchase price of the TI part(s) at issue in this document sold by TI to Customer on an annual basis.

PAG (S-PQFP-G64)

PLASTIC QUAD FLATPACK



- NOTES: A. All linear dimensions are in millimeters.
 B. This drawing is subject to change without notice.
 C. Falls within JEDEC MS-026

IMPORTANT NOTICE AND DISCLAIMER

TI PROVIDES TECHNICAL AND RELIABILITY DATA (INCLUDING DATASHEETS), DESIGN RESOURCES (INCLUDING REFERENCE DESIGNS), APPLICATION OR OTHER DESIGN ADVICE, WEB TOOLS, SAFETY INFORMATION, AND OTHER RESOURCES "AS IS" AND WITH ALL FAULTS, AND DISCLAIMS ALL WARRANTIES, EXPRESS AND IMPLIED, INCLUDING WITHOUT LIMITATION ANY IMPLIED WARRANTIES OF MERCHANTABILITY, FITNESS FOR A PARTICULAR PURPOSE OR NON-INFRINGEMENT OF THIRD PARTY INTELLECTUAL PROPERTY RIGHTS.

These resources are intended for skilled developers designing with TI products. You are solely responsible for (1) selecting the appropriate TI products for your application, (2) designing, validating and testing your application, and (3) ensuring your application meets applicable standards, and any other safety, security, or other requirements. These resources are subject to change without notice. TI grants you permission to use these resources only for development of an application that uses the TI products described in the resource. Other reproduction and display of these resources is prohibited. No license is granted to any other TI intellectual property right or to any third party intellectual property right. TI disclaims responsibility for, and you will fully indemnify TI and its representatives against, any claims, damages, costs, losses, and liabilities arising out of your use of these resources.

TI's products are provided subject to TI's Terms of Sale (www.ti.com/legal/termsofsale.html) or other applicable terms available either on ti.com or provided in conjunction with such TI products. TI's provision of these resources does not expand or otherwise alter TI's applicable warranties or warranty disclaimers for TI products.

Mailing Address: Texas Instruments, Post Office Box 655303, Dallas, Texas 75265
Copyright © 2020, Texas Instruments Incorporated