



Dual Comparators with 400mV Reference

Preliminary Technical Data

ADCMP670

FEATURES

- Low Quiescent Current: 6.5 μ A Typ
- Supply Range: 1.7V to 5.5V
- 400mV Reference \pm 0.8% Accuracy Over Temperature
- Input Range Includes Ground
- Internal Hysteresis: 6.5mV Typ
- Low Input Bias Current: \pm 10nA Max
- 40mA Typical Output Sink Current
- Supports Wired-AND Connections
- Input Polarities: One inverting and one noninverting
- Low Profile (1mm) TSOT Package

APPLICATIONS

- Battery-Powered System Monitoring
- Threshold Detectors
- Window Comparators
- Relay Driving
- Optoisolator Driving
- Industrial Control Systems
- Handheld Instruments

GENERAL DESCRIPTION

The ADCMP670 combine two low power, low voltage comparators with a 400mV reference in the 6-lead TSOT package. Operating within a supply range of 1.7V to 5.5V, the devices only draw 6.5 μ A typical, making them ideal for low voltage system monitoring and portable applications. Hysteresis is included in the comparators to insure stable output operation. Each comparator has only one input available externally, the other inputs are connected internally to the reference. The comparator outputs are open collector and the output load can be referred to any voltage up to supply voltage. The output stage sinking capability guaranteed greater than 5mA over temperature.

The ADCMP670 has one inverting input and one non-inverting input, making it suitable for use as a window comparator. Available in commercial, industrial and automotive temperature ranges.

FUNCTIONAL BLOCK DIAGRAM

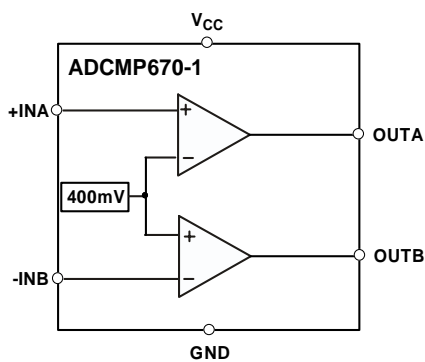

Figure 1.

Rev. PrB

Information furnished by Analog Devices is believed to be accurate and reliable. However, no responsibility is assumed by Analog Devices for its use, nor for any infringements of patents or other rights of third parties that may result from its use. Specifications subject to change without notice. No license is granted by implication or otherwise under any patent or patent rights of Analog Devices. Trademarks and registered trademarks are the property of their respective owners.

One Technology Way, P.O. Box 9106, Norwood, MA 02062-9106, U.S.A.
Tel: 781.329.4700 www.analog.com
Fax: 781.461.3113

©2006 Analog Devices, Inc. All rights reserved.

TABLE OF CONTENTS

Specifications.....	3	Applications INFORMATION	12
Absolute Maximum Ratings.....	5	Comparators and Internal reference.....	12
ESD Caution.....	5	Adding Hysteresis.....	12
Pin Configuration and Function Descriptions.....	6	Outline Dimensions	13
Typical Performance Characteristics	7	Ordering Guide	13

REVISION HISTORY

SPECIFICATIONS

Table 1.

$V_{CC} = 1.7V$ to $5.5V$, $T_A = 25^\circ C$, unless otherwise noted.

Parameter	Min	Typ	Max	Unit	Test Conditions/Comments
Rising Input Threshold Voltage	TBD	400	TBD	mV	$V_s = 1.7V$, Note1
	TBD	400	TBD	mV	$V_s = 5V$, Note1
Falling Input Threshold Voltage	TBD	393.5	TBD	mV	$V_s = 1.7V$, Note1
	TBD	393.5	TBD	mV	$V_s = 5V$, Note1
Hysteresis = $V_{TH(R)} - V_{TH(F)}$	TBD	6.5	TBD	mV	Note1
Input Bias Current		0.01	TBD	nA	$V_s = 1.7V$, $V_{in} = V_s$
		4	TBD	nA	$V_s = 1.7V$, $V_{in} = 0.1V$
Output Low Voltage		60	TBD	mV	$V_s = 1.7V$, $I_{out} = 3mA$, Note2
		70	TBD	mV	$V_s = 5V$, $I_{out} = 5mA$, Note2
Output Leakage Current		0.01	TBD	μA	$V_s = 1.7V$, $V_{out} = V_s$, Note3
		0.01	TBD	μA	$V_s = 1.7V$, $V_{out} = 5.5V$, Note3
High-to-Low Propagation Delay		29		μs	$V_s = 5V$, $V_{ol} = 400mV$, Note2,4
Low-to-High Propagation Delay		18		μs	$V_s = 5V$, $V_{oh} = 0.9 \times V_s$, Note2,4
Output Rise time		2.2		μs	$V_s = 5V$, $V_o = (0.1 \text{ to } 0.9) \times V_s$, Note2,4
Output Fall time		0.22		μs	$V_s = 5V$, $V_o = (0.1 \text{ to } 0.9) \times V_s$, Note2,4
Supply Current			TBD	μA	$V_s = 1.7V$
			TBD	μA	$V_s = 5.5V$

Table 2

$V_{CC} = 1.7V$ to $5.5V$, $0^\circ C \leq T_A \leq 70^\circ C$, unless otherwise noted.

Parameter	Min	Typ	Max	Unit	Test Conditions/Comments
Rising Input Threshold Voltage	TBD		TBD	mV	$V_s = 1.7V$, Note1
	TBD		TBD	mV	$V_s = 5V$, Note1
Falling Input Threshold Voltage	TBD		TBD	mV	$V_s = 1.7V$, Note1
	TBD		TBD	mV	$V_s = 5V$, Note1
Hysteresis = $V_{TH(R)} - V_{TH(F)}$	TBD		TBD	mV	Note1
Input Bias Current			TBD	nA	$V_s = 1.7V$, $V_{in} = V_s$
			TBD	nA	$V_s = 1.7V$, $V_{in} = 0.1V$
Output Low Voltage			TBD	mV	$V_s = 1.7V$, $I_{out} = 3mA$, Note2
			TBD	mV	$V_s = 5V$, $I_{out} = 5mA$, Note2
Output Leakage Current			TBD	μA	$V_s = 1.7V$, $V_{out} = V_s$, Note3
			TBD	μA	$V_s = 1.7V$, $V_{out} = 5.5V$, Note3
Supply Current			TBD	μA	$V_s = 1.7V$
			TBD	μA	$V_s = 5.5V$

Table 3

$V_{CC} = 1.7V$ to $5.5V$, $-40^{\circ}C \leq T_A \leq 85^{\circ}C$, unless otherwise noted.

Parameter	Min	Typ	Max	Unit	Test Conditions/Comments
Rising Input Threshold Voltage	TBD		TBD	mV	$V_s = 1.7V$, Note1
	TBD		TBD	mV	$V_s = 5V$, Note1
Falling Input Threshold Voltage	TBD		TBD	mV	$V_s = 1.7V$, Note1
	TBD		TBD	mV	$V_s = 5V$, Note1
Hysteresis = $V_{TH(R)} - V_{TH(F)}$	TBD		TBD	mV	Note1
Input Bias Current			TBD	nA	$V_s = 1.7V$, $V_{in} = V_s$
			TBD	nA	$V_s = 1.7V$, $V_{in} = 0.1V$
Output Low Voltage			TBD	mV	$V_s = 1.7V$, $I_{out} = 3mA$, Note2
			TBD	mV	$V_s = 5V$, $I_{out} = 5mA$, Note2
Output Leakage Current			TBD	μA	$V_s = 1.7V$, $V_{out} = V_s$, Note3
			TBD	μA	$V_s = 1.7V$, $V_{out} = 5.5V$, Note3
Supply Current			TBD	μA	$V_s = 1.7V$
			TBD	μA	$V_s = 5.5V$

Table 4

$V_{CC} = 1.7V$ to $5.5V$, $-40^{\circ}C \leq T_A \leq 125^{\circ}C$, unless otherwise noted.

Parameter	Min	Typ	Max	Unit	Test Conditions/Comments
Rising Input Threshold Voltage	TBD		TBD	mV	$V_s = 1.7V$, Note1
	TBD		TBD	mV	$V_s = 5V$, Note1
Falling Input Threshold Voltage	TBD		TBD	mV	$V_s = 1.7V$, Note1
	TBD		TBD	mV	$V_s = 5V$, Note1
Hysteresis = $V_{TH(R)} - V_{TH(F)}$	TBD		TBD	mV	Note1
Input Bias Current			TBD	nA	$V_s = 1.7V$, $V_{in} = V_s$
			TBD	nA	$V_s = 1.7V$, $V_{in} = 0.1V$
Output Low Voltage			TBD	mV	$V_s = 1.7V$, $I_{out} = 3mA$, Note2
			TBD	mV	$V_s = 5V$, $I_{out} = 5mA$, Note2
Output Leakage Current			TBD	μA	$V_s = 1.7V$, $V_{out} = V_s$, Note3
			TBD	μA	$V_s = 1.7V$, $V_{out} = 5.5V$, Note3
Supply Current			TBD	μA	$V_s = 1.7V$
			TBD	μA	$V_s = 5.5V$

Note1: $R_L = 100K$, $V_O = 2V$ Swing

Note2: 10mV input overdrive

Note3: $V_{in} = 40mV$ overdrive

Note4: $R_L = 10K$

Note5: No load

ABSOLUTE MAXIMUM RATINGS

T_A = 25°C, unless otherwise noted.

Table 5.

Parameter	Rating
V _s	−0.3V to +6V
IN _x	−0.3V to +6V
OUT _x	−0.3V to +6V
Operating Temperature Range	−40°C to +125°C
Storage Temperature Range	−65°C to +150°C
θ _{JA} Thermal Impedance, SC70	146°C/W
Lead Temperature	
Soldering (10 sec)	300°C
Vapor Phase (60 sec)	215°C
Infrared (15 sec)	220°C

Stresses above those listed under Absolute Maximum Ratings may cause permanent damage to the device. This is a stress rating only and functional operation of the device at these or any other conditions above those indicated in the operational section of this specification is not implied. Exposure to absolute maximum rating conditions for extended periods may affect device reliability.

ESD CAUTION

ESD (electrostatic discharge) sensitive device. Electrostatic charges as high as 4000 V readily accumulate on the human body and test equipment and can discharge without detection. Although this product features proprietary ESD protection circuitry, permanent damage may occur on devices subjected to high energy electrostatic discharges. Therefore, proper ESD precautions are recommended to avoid performance degradation or loss of functionality.



PIN CONFIGURATION AND FUNCTION DESCRIPTIONS

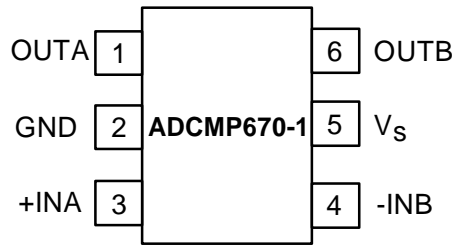

Figure 2. Pin Configuration

Table 6. Pin Function Descriptions

Pin No.	Mnemonic	Description
1	OUTA	Open Drain Output for comparator A. Capable of sinking up to 40mA of current.
2	GND	Ground.
3	+INA	Monitors Analog Input Voltage on comparator A. Connected to noninverting input. The other input of comparator A is connected to a 400mV reference.
4	-INB	Monitors Analog Input Voltage on comparator B. Connected to inverting input. The other input of comparator B is connected to a 400mV reference.
5	Vs	Power Supply. Operates from 1.7V to 5.5V.
6	OUTB	Open Drain Output for comparator B. Capable of sinking up to 40mA of current.

TYPICAL PERFORMANCE CHARACTERISTICS

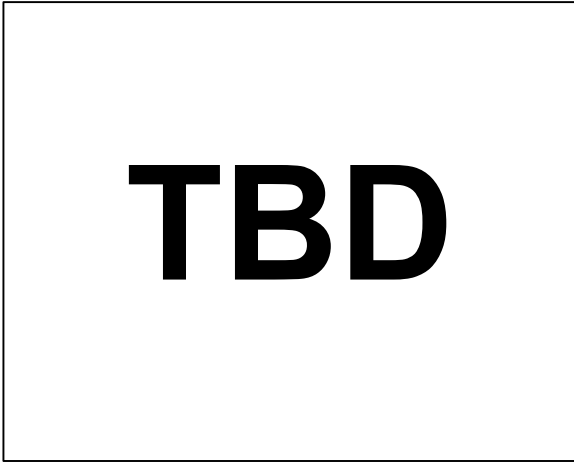

Figure 3. Distribution of Rising Input Threshold Voltage

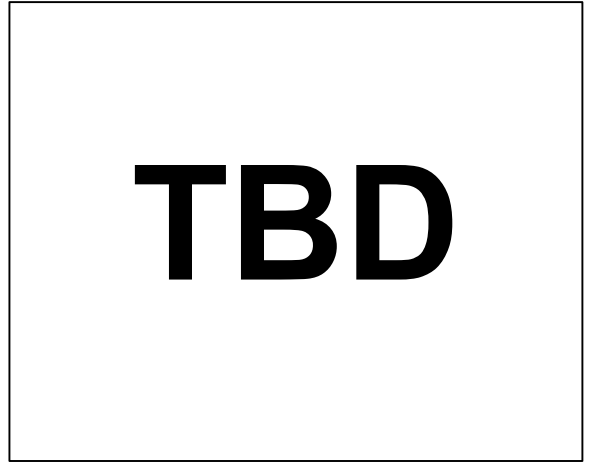

Figure 6. Distribution of Falling Input Threshold Voltage

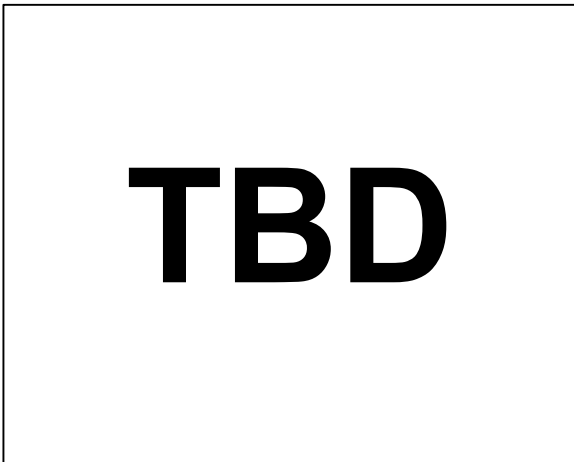

Figure 4. Distribution of Hysteresis

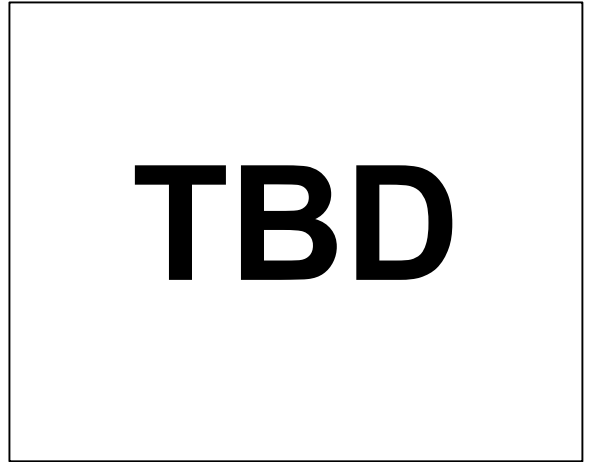

Figure 7. Rising Input Threshold Voltage vs Temperature

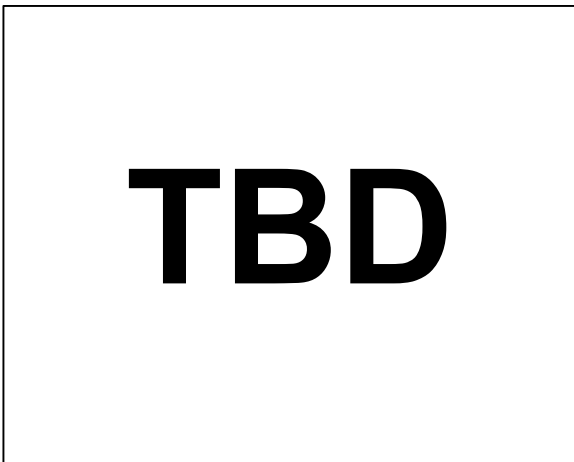

Figure 5. Rising Input Threshold Voltage vs Temperature

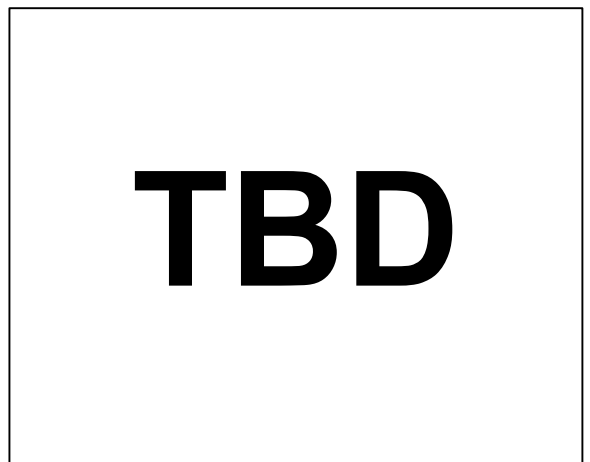

Figure 8. Rising Input Threshold Voltage vs Supply Voltage

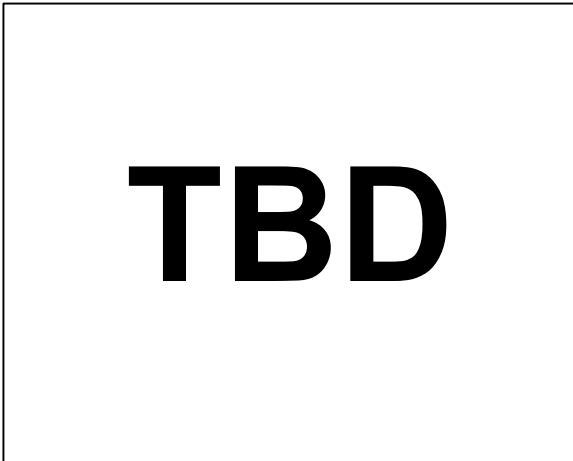

Figure 9. Hysteresis vs Temperature

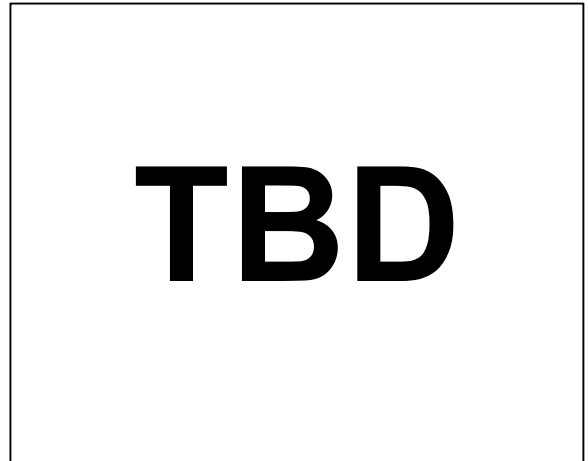

Figure 12. Hysteresis vs Temperature

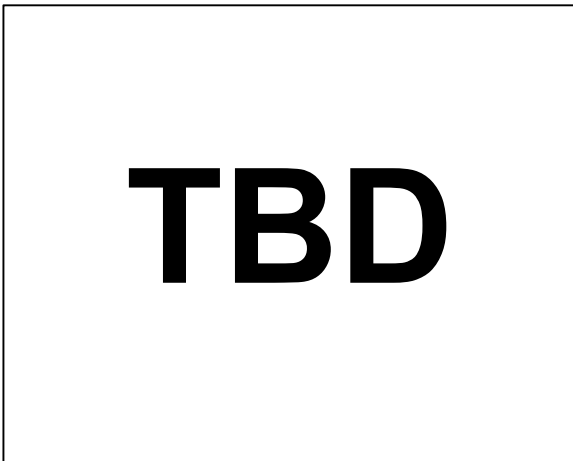

Figure 10. Hysteresis vs Supply Voltage

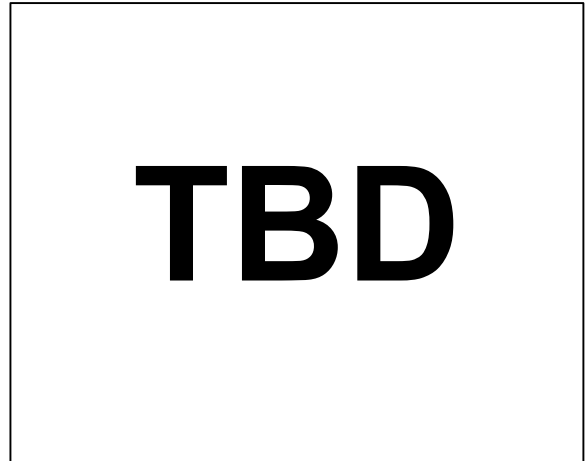

Figure 13. Minimum Supply Voltage

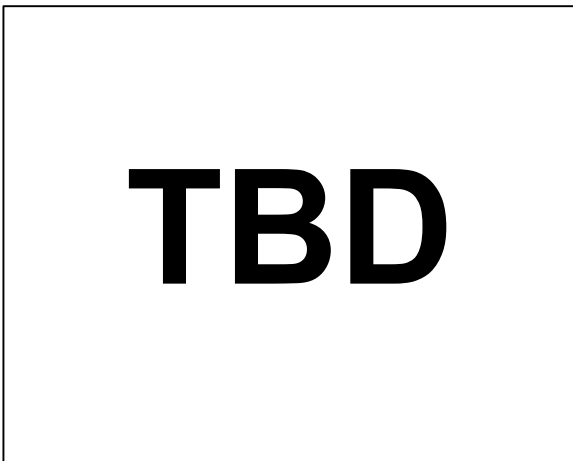

Figure 11. Quiescent Supply Current vs Supply Voltage

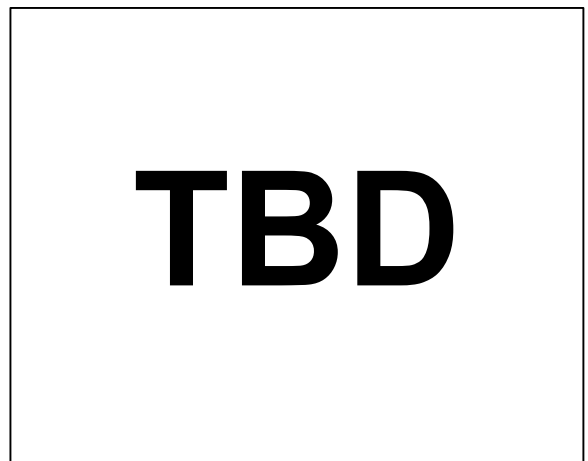

Figure 14. Startup Supply Current

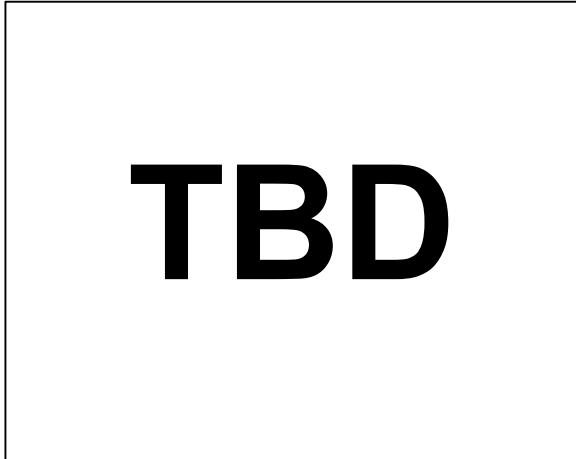

Figure 15. Supply Current vs Output Sink Current

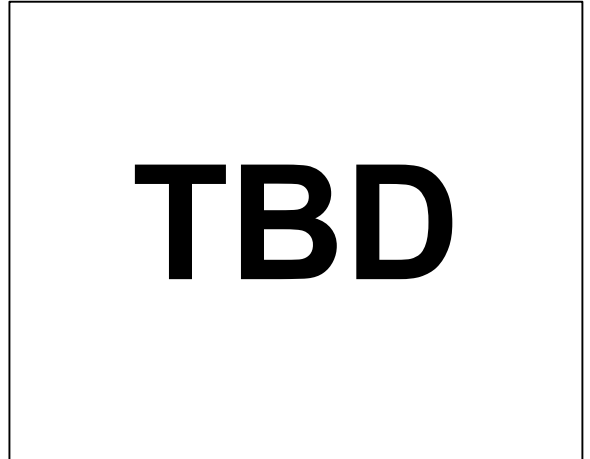

Figure 18. Below Ground Input Bias Current

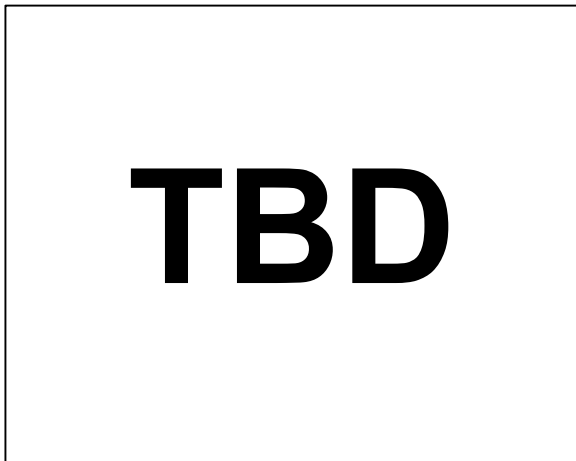

Figure 16 Supply Current vs Output Sink Current

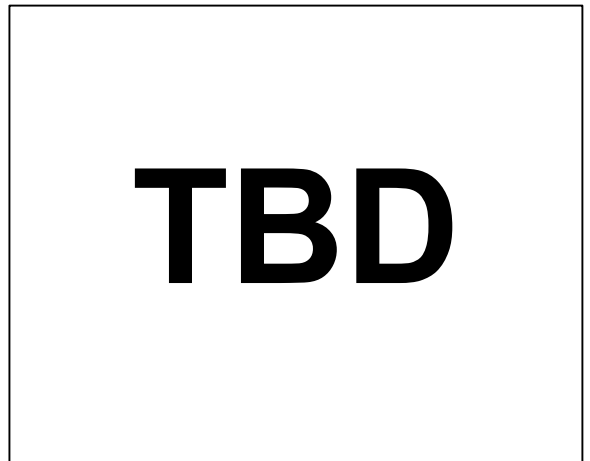

Figure 19. Low Level Input Bias Current

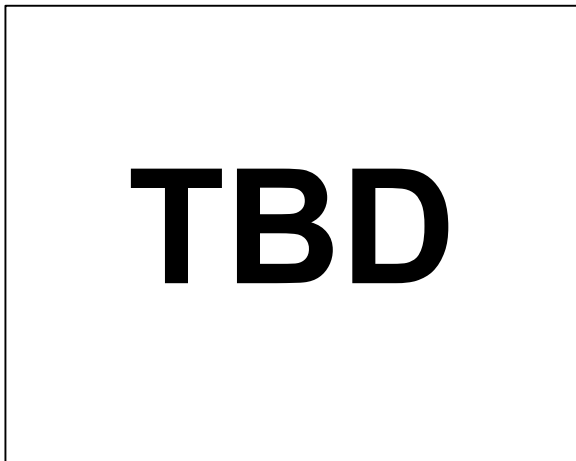

Figure 17. Supply Current vs Output Sink Current

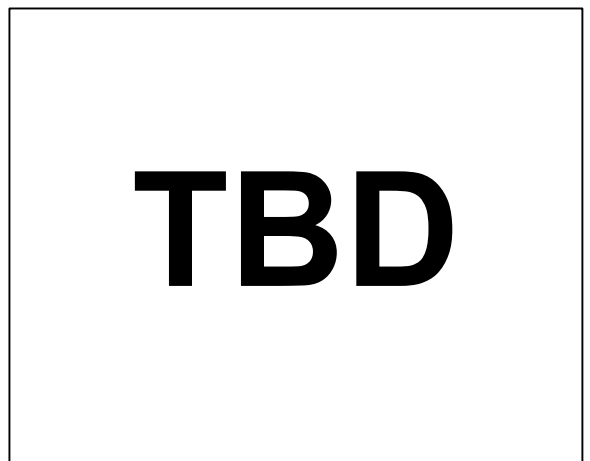

Figure 20 High Level Input Bias Current

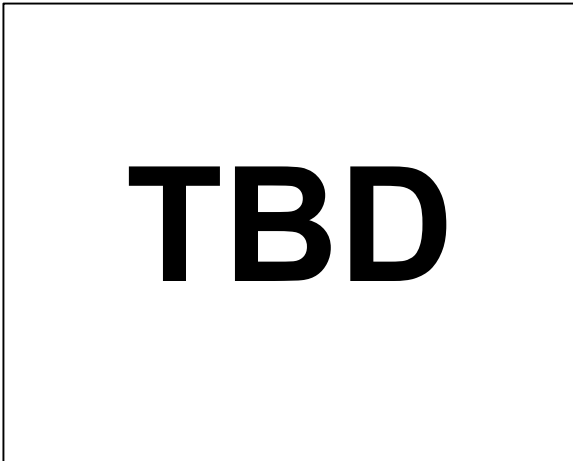

Figure 21. Output Saturation Voltage vs Output Sink Current

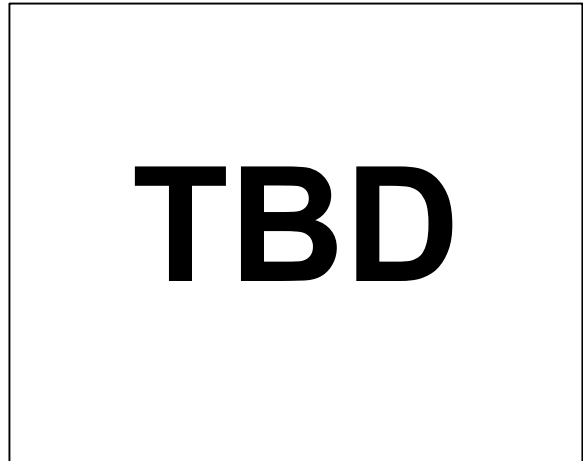

Figure 24. Output Short Circuit Current

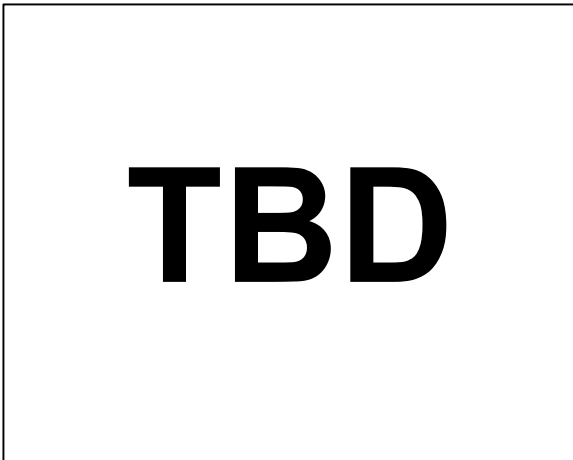

Figure 22 Output Saturation Voltage vs Output Sink Current

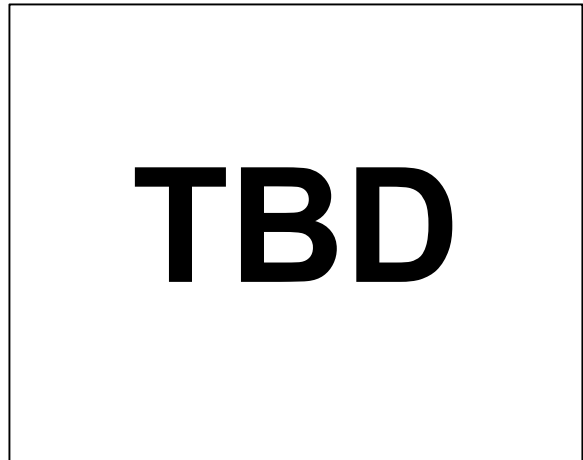

Figure 25. Output Short Circuit Current

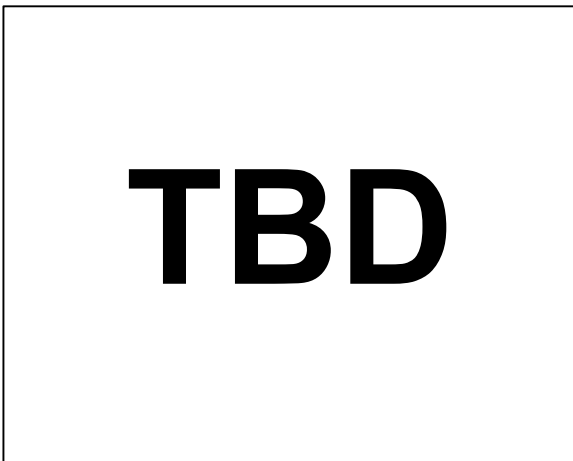

Figure 23. Output Saturation Voltage vs Output Sink Current

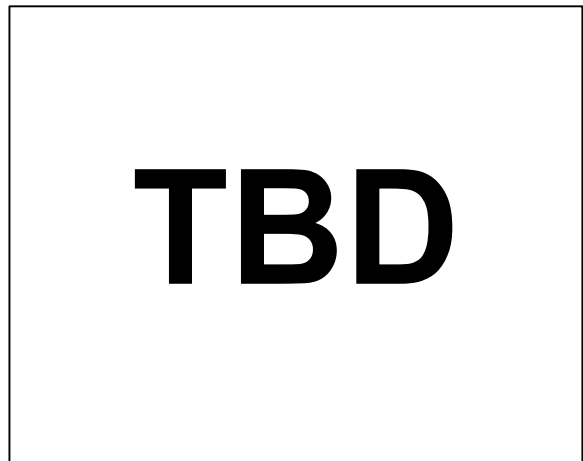

Figure 26. Output Leakage current

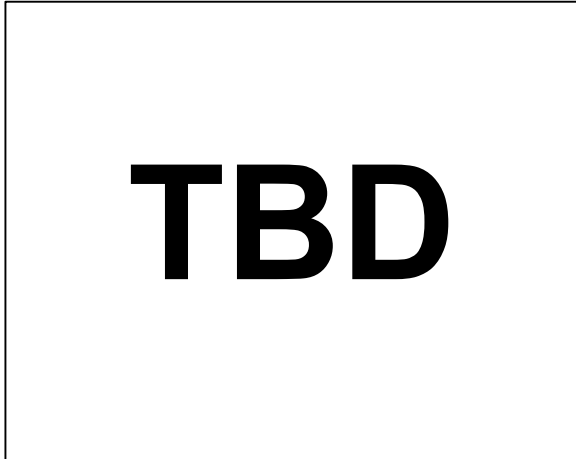

Figure 27. Propagation Delay vs Input Overdrive

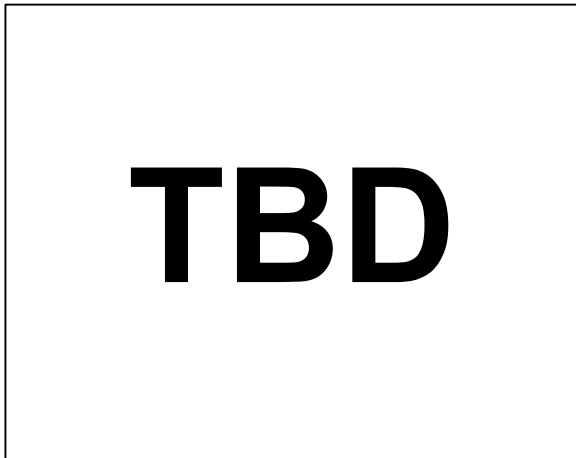

Figure 28. Non Inverting and Inverting comparators Propagation Delay

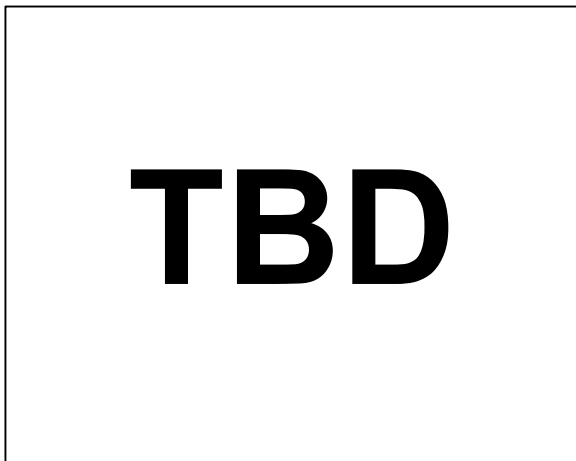

Figure 29. Rise and Fall Times vs Output Pullup Resistor

APPLICATIONS INFORMATION

The ADCMP670 is a dual low power comparators with a built in 400mV reference that operates from 1.7V to 5.5V. The comparators are approx 0.8% accurate with a built in hysteresis of approx 6.5mV. The outputs are open drain capable of sinking 40mA

COMPARATORS AND INTERNAL REFERENCE

Each of the comparators has one input available externally, comparator A has a noninverting input and comparator B has an inverting input available. The other comparator inputs are connected internally to the 400mV reference. The rising input threshold voltage of the comparators is designed to be equal to that of the reference (i.e. $\approx 400\text{mV}$).

ADDING HYSTERESIS

To prevent oscillations at the output caused by noise or slowly moving signals passing the switching threshold, each comparator has built-in hysteresis of approximately 6.5mV. Positive feedback can be used to adjust hysteresis to the noninverting comparators.

OUTLINE DIMENSIONS

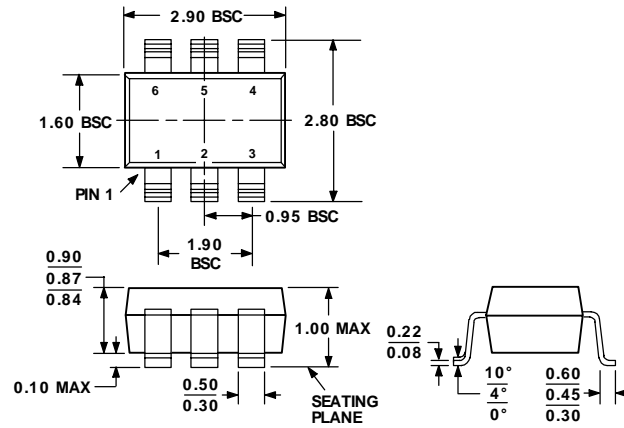

Figure 2. 6-Lead TSOT Package (UJ-6)—Dimensions shown in millimeters

ORDERING GUIDE

Model	Temperature Range	Package Description	Branding	Package Outline
ADCMP670-1AUJ	-40°C to +125°C	TSOT, 6 lead		UJ-6

NOTES