

## FEATURES

1.8 V to 5.5 V single supply

4 Ω (max) on resistance

Low on resistance flatness

−3 dB bandwidth >200 MHz

Tiny package options

8-lead MSOP

3 mm × 2 mm LFCSP (A grade)

Fast switching times

$t_{ON}$ , 20 ns

$t_{OFF}$ , 10 ns

Low power consumption (<0.1 μW)

TTL/CMOS compatible

## APPLICATIONS

USB 1.1 signal switching circuits

Cell phones

PDA's

Battery-powered systems

Communication systems

Sample hold systems

Audio signal routing

Video switching

Mechanical reed relay replacement

## GENERAL DESCRIPTION

The ADG721, ADG722, and ADG723 are monolithic CMOS SPST switches. These switches are designed on an advanced submicron process that provides low power dissipation yet gives high switching speed, low on resistance, and low leakage currents. The devices are packaged in both a tiny 3 mm × 2 mm LFCSP and an MSOP, making them ideal for space-constrained applications.

The ADG721, ADG722, and ADG723 are designed to operate from a single 1.8 V to 5.5 V supply, making them ideal for use in battery-powered instruments and with the new generation of DACs and ADCs from Analog Devices, Inc.

The ADG721, ADG722, and ADG723 contain two independent single-pole/single-throw (SPST) switches. The ADG721 and ADG722 differ only in that both switches are normally open

## FUNCTIONAL BLOCK DIAGRAMS

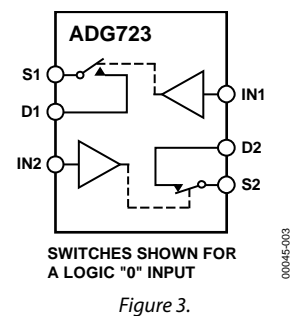
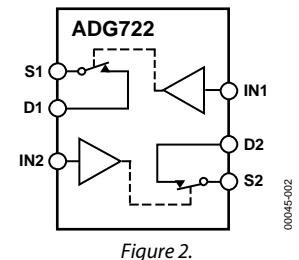
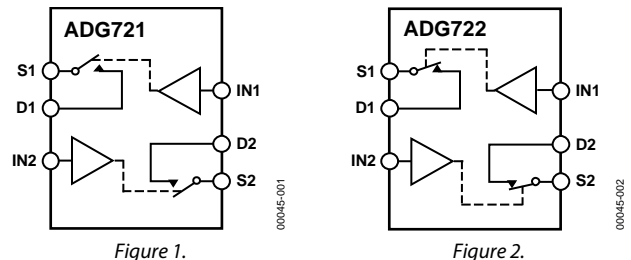

and normally closed, respectively. In the ADG723, Switch 1 is normally open and Switch 2 is normally closed.

Each switch of the ADG721, ADG722, and ADG723 conducts equally well in both directions when on. The ADG723 exhibits break-before-make switching action.

## PRODUCT HIGHLIGHTS

1. 1.8 V to 5.5 V single-supply operation.
2. Very low  $R_{ON}$  (4 Ω max at 5 V, 10 Ω max at 3 V).
3. Low on resistance flatness.
4. −3 dB bandwidth >200 MHz.
5. Low power dissipation. CMOS construction ensures low power dissipation.
6. 8-lead MSOP and 3 mm × 2 mm LFCSP.

### Rev. E

Information furnished by Analog Devices is believed to be accurate and reliable. However, no responsibility is assumed by Analog Devices for its use, nor for any infringements of patents or other rights of third parties that may result from its use. Specifications subject to change without notice. No license is granted by implication or otherwise under any patent or patent rights of Analog Devices. Trademarks and registered trademarks are the property of their respective owners.

**TABLE OF CONTENTS**

Features .....	1	Terminology .....	7
Applications.....	1	Typical Performance Characteristics .....	8
Functional Block Diagrams.....	1	Test Circuits.....	10
General Description .....	1	Applications.....	12
Product Highlights .....	1	ADG721/ADG722/ADG723 Supply Voltages .....	12
Revision History .....	2	On Response vs. Frequency .....	12
Specifications.....	3	Off Isolation .....	12
Absolute Maximum Ratings.....	5	Outline Dimensions .....	13
ESD Caution.....	5	Ordering Guide .....	14
Pin Configuration and Pin Descriptions.....	6		

**REVISION HISTORY**

<b>10/11—Rev. D to Rev. E</b>	
Changes to Ordering Guide .....	
<b>4/11—Rev. C to Rev. D</b>	
Changes to Ordering Guide .....	14
<b>1/11—Rev. B to Rev. C</b>	
Changes to Table 4.....	6
Changes to Ordering Guide .....	14
<b>2/07—Rev. A to Rev. B</b>	
Updated Format .....	Universal
Changes to Specifications .....	3
Changes to Absolute Maximum Ratings .....	5
Change to Figure 4 .....	6
Updated Outline Dimensions .....	13
Changes to Ordering Guide .....	13
<b>3/04—Rev. 0 to Rev. A</b>	
Additions to Applications.....	1
Changes to Ordering Guide .....	4
Updated Outline Dimensions .....	10

## SPECIFICATIONS

$V_{DD} = 5\text{ V} \pm 10\%$ ,  $GND = 0\text{ V}$ . All specifications  $-40^\circ\text{C}$  to  $+85^\circ\text{C}$ , unless otherwise noted.

Table 1.

Parameter	A, B Grade <sup>1</sup>		Unit	Test Conditions/Comments
	+25°C	-40°C to +85°C		
<b>ANALOG SWITCH</b>				
Analog Signal Range		0 to $V_{DD}$	V	
On Resistance, $R_{ON}$	2.5		$\Omega$ typ	$V_S = 0\text{ V}$ to $V_{DD}$ , $I_S = -10\text{ mA}$
	4	5	$\Omega$ max	See Figure 12
On Resistance Match Between Channels, $\Delta R_{ON}$	0.3		$\Omega$ typ	$V_S = 0\text{ V}$ to $V_{DD}$ , $I_S = -10\text{ mA}$
		1.0	$\Omega$ max	
On Resistance Flatness, $R_{FLAT(ON)}$	0.85		$\Omega$ typ	$V_S = 0\text{ V}$ to $V_{DD}$ , $I_S = -10\text{ mA}$
		1.5	$\Omega$ max	
<b>LEAKAGE CURRENTS – A Grade</b>				
Source off Leakage, $I_S$ (OFF)	$\pm 0.01$		nA typ	$V_{DD} = 5.5\text{ V}$ $V_S = 4.5\text{ V}/1\text{ V}$ , $V_D = 1\text{ V}/4.5\text{ V}$ , see Figure 13
Drain off Leakage, $I_D$ (OFF)	$\pm 0.01$		nA typ	$V_S = 4.5\text{ V}/1\text{ V}$ , $V_D = 1\text{ V}/4.5\text{ V}$ , see Figure 13
Channel on Leakage, $I_D$ , $I_S$ (ON)	$\pm 0.01$		nA typ	$V_S = V_D = 1\text{ V}$ or $V_S = V_D = 4.5\text{ V}$ , see Figure 14
<b>LEAKAGE CURRENTS – B Grade</b>				
Source off Leakage, $I_S$ (OFF)	$\pm 0.01$		nA typ	$V_{DD} = 5.5\text{ V}$ $V_S = 4.5\text{ V}/1\text{ V}$ , $V_D = 1\text{ V}/4.5\text{ V}$
	$\pm 0.25$	$\pm 0.35$	nA max	Test Circuit 2
Drain off Leakage, $I_D$ (OFF)	$\pm 0.01$		nA typ	$V_S = 4.5\text{ V}/1\text{ V}$ , $V_D = 1\text{ V}/4.5\text{ V}$
	$\pm 0.25$	$\pm 0.35$	nA max	See Figure 13
Channel on Leakage, $I_D$ , $I_S$ (ON)	$\pm 0.01$		nA typ	$V_S = V_D = 1\text{ V}$ or $V_S = V_D = 4.5\text{ V}$
	$\pm 0.25$	$\pm 0.35$	nA max	See Figure 14
<b>DIGITAL INPUTS</b>				
Input High Voltage, $V_{INH}$		2.4	V min	
Input Low Voltage, $V_{INL}$		0.8	V max	
Input Current				
$I_{INL}$ or $I_{INH}$	0.005		$\mu\text{A}$ typ	$V_{IN} = V_{INL}$ or $V_{INH}$
		$\pm 0.1$	$\mu\text{A}$ max	
<b>DYNAMIC CHARACTERISTICS<sup>2</sup></b>				
$t_{ON}$	14		ns typ	$R_L = 300\ \Omega$ , $C_L = 35\text{ pF}$
		20	ns max	$V_S = 3\text{ V}$ , see Figure 15
$t_{OFF}$	6		ns typ	$R_L = 300\ \Omega$ , $C_L = 35\text{ pF}$
		10	ns max	$V_S = 3\text{ V}$ , see Figure 15
Break-Before-Make Time Delay, $t_D$ (ADG723 Only)	7		ns typ	$R_L = 300\ \Omega$ , $C_L = 35\text{ pF}$
		1	ns min	$V_{S1} = V_{S2} = 3\text{ V}$ , see Figure 16
Charge Injection	2		pC typ	$V_S = 2\text{ V}$ , $R_S = 0\ \Omega$ , $C_L = 1\text{ nF}$ , see Figure 17
Off Isolation	-60		dB typ	$R_L = 50\ \Omega$ , $C_L = 5\text{ pF}$ , $f = 10\text{ MHz}$
	-80		dB typ	$R_L = 50\ \Omega$ , $C_L = 5\text{ pF}$ , $f = 1\text{ MHz}$ , see Figure 18
Channel-to-Channel Crosstalk	-77		dB typ	$R_L = 50\ \Omega$ , $C_L = 5\text{ pF}$ , $f = 10\text{ MHz}$
	-97		dB typ	$R_L = 50\ \Omega$ , $C_L = 5\text{ pF}$ , $f = 1\text{ MHz}$ , see Figure 19
Bandwidth -3 dB	200		MHz typ	$R_L = 50\ \Omega$ , $C_L = 5\text{ pF}$ , see Figure 20
$C_S$ (OFF)	7		pF typ	
$C_D$ (OFF)	7		pF typ	
$C_D$ , $C_S$ (ON)	18		pF typ	
<b>POWER REQUIREMENTS</b>				
$I_{DD}$	0.001		$\mu\text{A}$ typ	$V_{DD} = 5.5\text{ V}$ Digital inputs = 0 V or 5 V
		1.0	$\mu\text{A}$ max	

<sup>1</sup> Temperature range: A, B grades,  $-40^\circ\text{C}$  to  $+85^\circ\text{C}$ . All specifications apply to both grades unless otherwise stated.

<sup>2</sup> Guaranteed by design; not subject to production test.

$V_{DD} = 3\text{ V} \pm 10\%$ ,  $GND = 0\text{ V}$ . All specifications  $-40^{\circ}\text{C}$  to  $+85^{\circ}\text{C}$ , unless otherwise noted.

Table 2.

Parameter	A, B Grades <sup>1</sup>		Unit	Test Conditions/Comments
	+25°C	-40°C to +85°C		
<b>ANALOG SWITCH</b>				
Analog Signal Range		0 to $V_{DD}$	V	
On Resistance, $R_{ON}$	6.5		$\Omega$ typ	$V_S = 0\text{ V}$ to $V_{DD}$ , $I_S = -10\text{ mA}$
		10	$\Omega$ max	See Figure 12
On Resistance Match Between Channels, $\Delta R_{ON}$	0.3		$\Omega$ typ	$V_S = 0\text{ V}$ to $V_{DD}$ , $I_S = -10\text{ mA}$
		1.0	$\Omega$ max	
On Resistance Flatness, $R_{FLAT(ON)}$	3.5		$\Omega$ typ	$V_S = 0\text{ V}$ to $V_{DD}$ , $I_S = -10\text{ mA}$
<b>LEAKAGE CURRENTS – A Grade</b>				
Source off Leakage, $I_S$ (OFF)	$\pm 0.01$		nA typ	$V_{DD} = 3.3\text{ V}$ $V_S = 3\text{ V}/1\text{ V}$ , $V_D = 1\text{ V}/3\text{ V}$ , see Figure 13
Drain off Leakage, $I_D$ (OFF)	$\pm 0.01$		nA typ	$V_S = 3\text{ V}/1\text{ V}$ , $V_D = 1\text{ V}/3\text{ V}$ , see Figure 13
Channel on Leakage, $I_D$ , $I_S$ (ON)	$\pm 0.01$		nA typ	$V_S = V_D = 1\text{ V}$ or $3\text{ V}$ , Figure 14
<b>LEAKAGE CURRENTS – B Grade</b>				
Source off Leakage, $I_S$ (OFF)	$\pm 0.01$		nA typ	$V_{DD} = 3.3\text{ V}$ $V_S = 3\text{ V}/1\text{ V}$ , $V_D = 1\text{ V}/3\text{ V}$
	$\pm 0.25$	$\pm 0.35$	nA max	See Figure 13
Drain off Leakage, $I_D$ (OFF)	$\pm 0.01$		nA typ	$V_S = 3\text{ V}/1\text{ V}$ , $V_D = 1\text{ V}/3\text{ V}$
	$\pm 0.25$	$\pm 0.35$	nA max	See Figure 13
Channel on Leakage, $I_D$ , $I_S$ (ON)	$\pm 0.01$		nA typ	$V_S = V_D = 1\text{ V}$ or $3\text{ V}$
	$\pm 0.25$	$\pm 0.35$	nA max	See Figure 14
<b>DIGITAL INPUTS</b>				
Input High Voltage, $V_{INH}$		2.0	V min	
Input Low Voltage, $V_{INL}$		0.4	V max	
Input Current				
$I_{INL}$ or $I_{INH}$	0.005		$\mu\text{A}$ typ	$V_{IN} = V_{INL}$ or $V_{INH}$
		$\pm 0.1$	$\mu\text{A}$ max	
<b>DYNAMIC CHARACTERISTICS<sup>2</sup></b>				
$t_{ON}$	16		ns typ	$R_L = 300\ \Omega$ , $C_L = 35\text{ pF}$
		24	ns max	$V_S = 2\text{ V}$ , see Figure 15
$t_{OFF}$	7		ns typ	$R_L = 300\ \Omega$ , $C_L = 35\text{ pF}$
		11	ns max	$V_S = 2\text{ V}$ , see Figure 15
Break-Before-Make Time Delay, $t_D$ (ADG723 Only)	7		ns typ	$R_L = 300\ \Omega$ , $C_L = 35\text{ pF}$
		1	ns min	$V_{S1} = V_{S2} = 2\text{ V}$ , see Figure 16
Charge Injection	2		pC typ	$V_S = 1.5\text{ V}$ , $R_S = 0\ \Omega$ , $C_L = 1\text{ nF}$ , see Figure 17
Off Isolation	-60		dB typ	$R_L = 50\ \Omega$ , $C_L = 5\text{ pF}$ , $f = 10\text{ MHz}$
	-80		dB typ	$R_L = 50\ \Omega$ , $C_L = 5\text{ pF}$ , $f = 1\text{ MHz}$ , see Figure 18
Channel-to-Channel Crosstalk	-77		dB typ	$R_L = 50\ \Omega$ , $C_L = 5\text{ pF}$ , $f = 10\text{ MHz}$
	-97		dB typ	$R_L = 50\ \Omega$ , $C_L = 5\text{ pF}$ , $f = 1\text{ MHz}$ , see Figure 19
Bandwidth -3 dB	200		MHz typ	$R_L = 50\ \Omega$ , $C_L = 5\text{ pF}$ , see Figure 20
$C_S$ (OFF)	7		pF typ	
$C_D$ (OFF)	7		pF typ	
$C_D$ , $C_S$ (ON)	18		pF typ	
<b>POWER REQUIREMENTS</b>				
$I_{DD}$	0.001		$\mu\text{A}$ typ	$V_{DD} = 3.3\text{ V}$ Digital inputs = $0\text{ V}$ or $3\text{ V}$
		1.0	$\mu\text{A}$ max	

<sup>1</sup> Temperature range: A, B Grades,  $-40^{\circ}\text{C}$  to  $+85^{\circ}\text{C}$ . All specifications apply to both grades unless otherwise stated.

<sup>2</sup> Guaranteed by design; not subject to production test.

## ABSOLUTE MAXIMUM RATINGS

T<sub>A</sub> = 25°C unless otherwise noted.

Table 3.

Parameter	Rating
V <sub>DD</sub> to GND	−0.3 V to +7 V
Analog, Digital Inputs <sup>1</sup>	−0.3 V to V <sub>DD</sub> + 0.3 V or 30 mA, whichever occurs first
Continuous Current, S or D	30 mA
Operating Temperature Range	
Industrial (A, B Grade)	−40°C to +85°C
Storage Temperature Range	−65°C to +150°C
Junction Temperature	+150°C
8-Lead MSOP	
θ <sub>JA</sub> Thermal Impedance	206°C/W
θ <sub>JC</sub> Thermal Impedance	44°C/W
8-Lead LFCSP (4-Layer Board)	
θ <sub>JA</sub> Thermal Impedance <sup>1</sup>	50.8°C/W
Lead Temperature, Soldering	
Vapor Phase (60 sec)	215°C
Infrared (15 sec)	220°C
Lead-Free Temperature, Soldering	
IR Reflow, Peak Temperature	260°C (+0/−5°C)
Time at Peak Temperature	10 sec to 40 sec
ESD	2 kV

<sup>1</sup>Assumes exposed paddle is tied to ground.

Stresses above those listed under Absolute Maximum Ratings may cause permanent damage to the device. This is a stress rating only; functional operation of the device at these or any other conditions above those indicated in the operational section of this specification is not implied. Exposure to absolute maximum rating conditions for extended periods may affect device reliability.

### ESD CAUTION



**ESD (electrostatic discharge) sensitive device.** Charged devices and circuit boards can discharge without detection. Although this product features patented or proprietary protection circuitry, damage may occur on devices subjected to high energy ESD. Therefore, proper ESD precautions should be taken to avoid performance degradation or loss of functionality.

## PIN CONFIGURATION AND PIN DESCRIPTIONS



Figure 4. Pin Configuration

Table 4. Pin Function Descriptions

Pin No.	Mnemonic	Descriptions
1	S1	Source Pin 1. May be an input or an output.
2	D1	Drain Pin 1. May be an input or an output.
3	IN2	Logic Control Input for Switch S2→D2.
4	GND	Ground (0 V) Reference.
5	S2	Source Pin 2. May be an input or an output.
6	D2	Drain Pin 2. May be an input or an output.
7	IN1	Logic Control Input for Switch S1→D1.
8	V <sub>DD</sub>	Positive Power Supply Input.

Table 5. Truth Table (ADG721/ADG722)

ADG721 In	ADG722 In	Switch Condition
0	1	Off
1	0	On

Table 6. Truth Table (ADG723)

Logic	Switch 1	Switch 2
0	Off	On
1	On	Off

## TERMINOLOGY

**V<sub>DD</sub>**

Most positive power supply potential.

**GND**

Ground (0 V) reference.

**S**

Source terminal. May be an input or output.

**D**

Drain terminal. May be an input or output.

**IN**

Logic control input.

**R<sub>ON</sub>**

Ohmic resistance between D and S.

**ΔR<sub>ON</sub>**

On resistance match between any two channels, that is,  
 $R_{ON\ max} - R_{ON\ min}$ .

**R<sub>FLAT(ON)</sub>**

Flatness is defined as the difference between the maximum and minimum value of on resistance as measured over the specified analog signal range.

**I<sub>S</sub> (OFF)**

Source leakage current with the switch off.

**I<sub>D</sub> (OFF)**

Drain leakage current with the switch off.

**I<sub>D</sub>, I<sub>S</sub> (ON)**

Channel leakage current with the switch on.

**V<sub>D</sub> (V<sub>S</sub>)**

Analog voltage on the D and S terminals.

**C<sub>S</sub> (OFF)**

Off switch source capacitance.

**C<sub>D</sub> (OFF)**

Off switch drain capacitance.

**C<sub>D</sub>, C<sub>S</sub> (ON)**

On switch capacitance.

**t<sub>ON</sub>**

Delay between applying the digital control input and the output switching on.

**t<sub>OFF</sub>**

Delay between applying the digital control input and the output switching off.

**t<sub>D</sub>**

Off time or on time measured between the 90% points of both switches, when switching from one address state to another (ADG723 only).

**Crosstalk**

A measure of unwanted signal that is the result of parasitic capacitance.

**Off Isolation**

A measure of unwanted signal coupling through an off switch.

**Charge Injection**

A measure of the glitch impulse transferred during switching.

TYPICAL PERFORMANCE CHARACTERISTICS



Figure 5. On Resistance as a Function of  $V_D$  ( $V_S$ ), Single Supplies

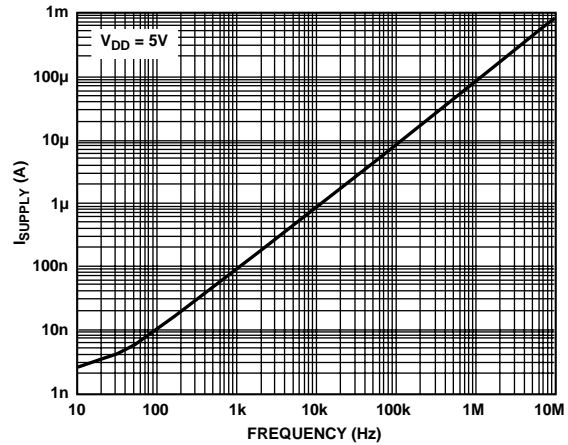

Figure 8. Supply Current vs. Input Switching Frequency



Figure 6. On Resistance as a Function of a  $V_D$  ( $V_S$ ) for Different Temperatures,  $V_{DD} = 3V$



Figure 9. Off Isolation vs. Frequency



Figure 7. On Resistance as a Function of  $V_D$  ( $V_S$ ) for Different Temperatures,  $V_{DD} = 5V$

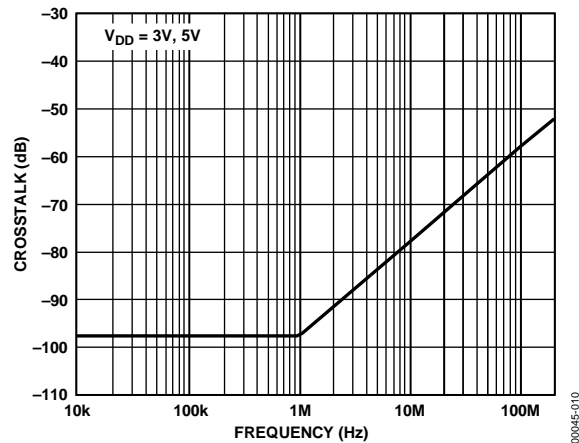

Figure 10. Crosstalk vs. Frequency





Figure 11. On Response vs. Frequency

TEST CIRCUITS



Figure 12. On Resistance



Figure 13. Off Leakage



Figure 14. On Leakage

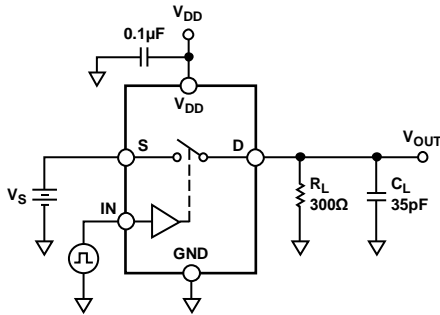

Figure 15. Switching Times



Figure 16. Break-Before-Make Time Delay,  $t_D$  (ADG723 Only)

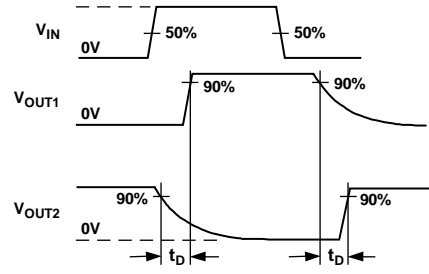

Figure 17. Charge Injection





Figure 18. Off Isolation

00045-018



Figure 19. Channel-to-Channel Crosstalk

00045-019



Figure 20. Bandwidth

00045-020

## APPLICATIONS

The ADG721/ADG722/ADG723 belong to a new family of Analog Devices CMOS switches. This series of general-purpose switches has improved switching times, lower on resistance, higher bandwidths, low power consumption, and low leakage currents.

### ADG721/ADG722/ADG723 SUPPLY VOLTAGES

Functionality of the ADG721/ADG722/ADG723 extends from a 1.8 V to a 5.5 V single supply, which makes it ideal for battery-powered instruments, where important design parameters are power efficiency and performance.

It is important to note that the supply voltage affects the input signal range, the on resistance, and the switching times of the part. The typical performance characteristics and the specifications clearly show the effects of the power supplies.

For  $V_{DD} = 1.8$  V, on resistance is typically 40  $\Omega$  over the temperature range.

### ON RESPONSE VS. FREQUENCY

Figure 21 illustrates the parasitic components that affect the ac performance of CMOS switches (the switch is shown surrounded by a box). Additional external capacitances further degrade some aspects of performance. These capacitances affect feedthrough, crosstalk, and system bandwidth.



Figure 21. Switch Represented by Equivalent Parasitic Components

The transfer function that describes the equivalent diagram of the switch (Figure 21) is of the form  $A(s)$ , as shown in the following equation:

$$A(s) = R_T \left[ \frac{s(R_{ON} C_{DS}) + 1}{s(R_{ON} C_T R_T) + 1} \right]$$

where:

$$C_T = C_{LOAD} + C_D + C_{DS}$$

$$R_T = R_{LOAD} / (R_{LOAD} + R_{ON})$$

The signal transfer characteristic is dependent on the switch channel capacitance,  $C_{DS}$ . This capacitance creates a frequency zero in the numerator of the transfer function  $A(s)$ . Because the switch on resistance is small, this zero usually occurs at high frequencies. The bandwidth is a function of the switch output capacitance combined with  $C_{DS}$  and the load capacitance. The frequency pole corresponding to these capacitances appears in the denominator of  $A(s)$ .

The dominant effect of the output capacitance,  $C_D$ , causes the pole breakpoint frequency to occur first. Therefore, in order to maximize bandwidth, a switch must have a low input and output capacitance and low on resistance (see Figure 11).

### OFF ISOLATION

Off isolation is a measure of the input signal coupled through an off switch to the switch output. The capacitance,  $C_{DS}$ , couples the input signal to the output load, when the switch is off, as shown in Figure 22.

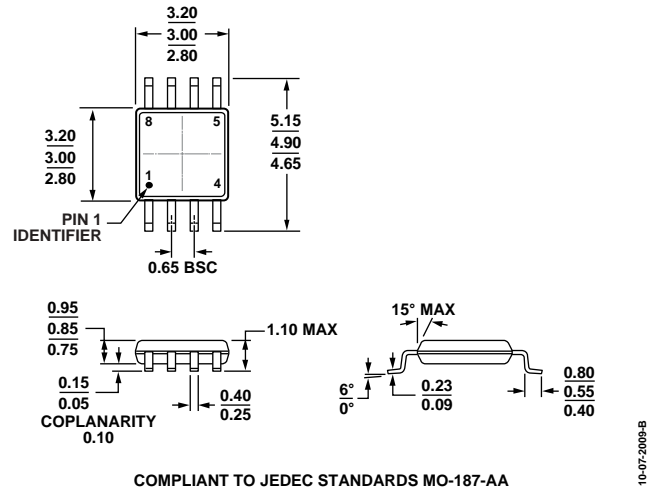

Figure 22. Off Isolation Is Affected by External Load Resistance and Capacitance

The larger the value of  $C_{DS}$ , the larger the value of feedthrough produced. Figure 9 illustrates the drop in off isolation as a function of frequency. From dc to roughly 1 MHz, the switch shows better than -80 dB isolation. Up to frequencies of 10 MHz, the off isolation remains better than -60 dB. As the frequency increases, more and more of the input signal is coupled through to the output. Off isolation can be maximized by choosing a switch with the smallest  $C_{DS}$  possible. The values of load resistance and capacitance also affect off isolation because they contribute to the coefficients of the poles and zeros in the transfer function of the switch when open.

$$A(s) = \left[ \frac{s(R_{LOAD} C_{DS})}{s(R_{LOAD})(C_{LOAD} + C_D + C_{DS}) + 1} \right]$$

# OUTLINE DIMENSIONS



COMPLIANT TO JEDEC STANDARDS MO-187-AA

Figure 23. 8-Lead Mini Small Outline Package [MSOP] (RM-8)

Dimensions shown in millimeters

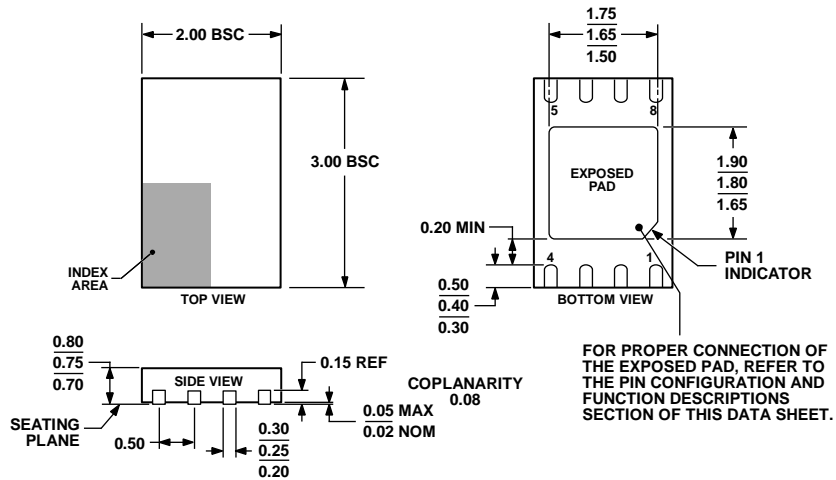

Figure 24. 8-Lead Lead Frame Chip Scale Package [LF CSP\_WD]

3 mm x 2 mm Body, Very Very Thin, Dual Lead (CP-8-4)

Dimensions shown in millimeters

## ORDERING GUIDE

Model <sup>1</sup>	Temperature Range	Package Description	Package Option	Branding <sup>2</sup>
ADG721BRM	-40°C to +85°C	8-Lead MSOP	RM-8	S6B
ADG721BRM-REEL	-40°C to +85°C	8-Lead MSOP	RM-8	S6B
ADG721BRM-REEL7	-40°C to +85°C	8-Lead MSOP	RM-8	S6B
ADG721BRMZ	-40°C to +85°C	8-Lead MSOP	RM-8	#S6B
ADG721BRMZ-REEL	-40°C to +85°C	8-Lead MSOP	RM-8	#S6B
ADG721BRMZ-REEL7	-40°C to +85°C	8-Lead MSOP	RM-8	#S6B
ADG721ACPZ-REEL	-40°C to +85°C	8-Lead LFCSP_WD	CP-8-4	17
ADG721ACPZ-REEL7	-40°C to +85°C	8-Lead LFCSP_WD	CP-8-4	17
ADG722BRM	-40°C to +85°C	8-Lead MSOP	RM-8	S7B
ADG722BRM-REEL7	-40°C to +85°C	8-Lead MSOP	RM-8	S7B
ADG722BRMZ	-40°C to +85°C	8-Lead MSOP	RM-8	#S7B
ADG722BRMZ-REEL	-40°C to +85°C	8-Lead MSOP	RM-8	#S7B
ADG722BRMZ-REEL7	-40°C to +85°C	8-Lead MSOP	RM-8	#S7B
ADG722ACPZ-REEL	-40°C to +85°C	8-Lead LFCSP_WD	CP-8-4	0U
ADG722ACPZ-REEL7	-40°C to +85°C	8-Lead LFCSP_WD	CP-8-4	0U
ADG723BRM	-40°C to +85°C	8-Lead MSOP	RM-8	S8B
ADG723BRM-REEL	-40°C to +85°C	8-Lead MSOP	RM-8	S8B
ADG723BRM-REEL7	-40°C to +85°C	8-Lead MSOP	RM-8	S8B
ADG723BRMZ	-40°C to +85°C	8-Lead MSOP	RM-8	#S8B
ADG723BRMZ-REEL	-40°C to +85°C	8-Lead MSOP	RM-8	#S8B
ADG723BRMZ-REEL7	-40°C to +85°C	8-Lead MSOP	RM-8	#S8B
ADG723ACPZ-REEL	-40°C to +85°C	8-Lead LFCSP_WD	CP-8-4	S2N
ADG723ACPZ-REEL7	-40°C to +85°C	8-Lead LFCSP_WD	CP-8-4	S2N

<sup>1</sup> Z = RoHS Compliant Part; # denotes lead-free product may be top or bottom marked.

<sup>2</sup> Branding = due to package size limitations, these three characters represent the part number.

**NOTES**

**NOTES**